

## **Description and Calibration Approach for DS1 IPS Diagnostics Sensors: Plasma Wave Spectrometer Channels**

David E. Brinza and Michael D. Henry  
Jet Propulsion Laboratory, Pasadena, California  
(PWS\_describe4\_1\_calib.doc)

### Plasma Wave Spectrometer Description

The Deep Space 1 (DS1) Ion Propulsion Subsystem (IPS) Diagnostic Sensor (IDS) includes a Plasma Wave Spectrometer (PWS) to characterize the AC electric and magnetic field environment. A block diagram of the IDS PWS is provided in Figure 1. The PWS includes a 2-meter tip-to-tip dipole Plasma Wave Antenna (PWA, E-field) and a miniature Search Coil Magnetometer (SCM, B-field) sensor. A second higher sensitivity SCM was integrated in the IDS, but had failed on the launch pad when subjected to high-level 60 Hz AC fields. The PWA has a pre-amplifier with voltage-controlled gain at the antenna. The SCM pre-amplifier is integral with the PWS circuit board. The PWS provides 24 spectrometer band-pass (16 ELFagc and 8 EHFagc) channels for the PWA measurement over the range of 15 Hz to 34 MHz and 16 (BLFagc) channels for the SCM (B-field) measurement over the range of 14 Hz to 82 kHz. The PWS also outputs waveform signals (ERAWout, BRAWout) through a 10 kHz low-pass filter to the IDS Fields Measurement Processor (FMP).

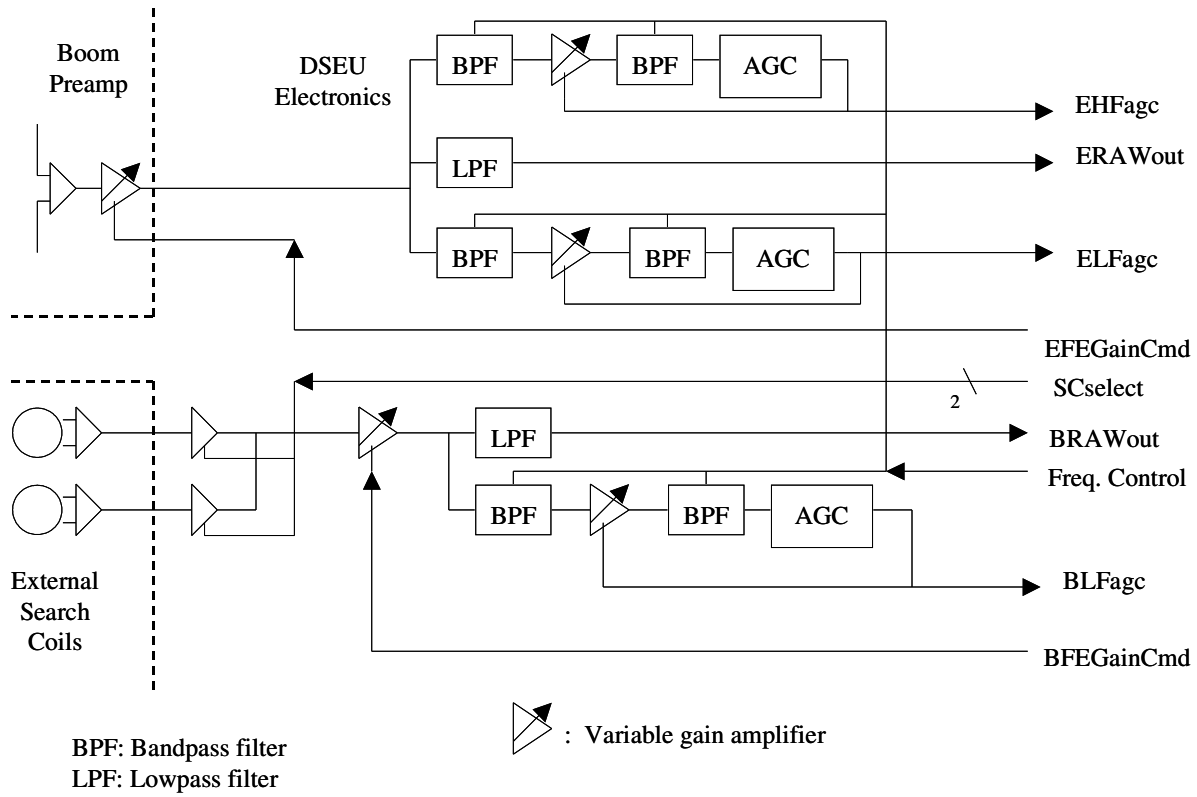

Figure 1. IDS Plasma Wave Spectrometer (PWS) block diagram

## PWA and SCM Calibration

The PWA pre-amplifier was separately characterized with the frequency response determined to be flat between the 20 Hz and 30 MHz 3dB points. The voltage-controlled gain was determined using an input signal at 1 kHz and varying the gain voltage over the operating range. The pre-amp gain response is shown in Figure 2. The “end-to-end” gain response (upper) line reflects the internal 20dB amplifier in the low-pass filter for the waveform output channel (ERAWout) in the PWS. The upper curve in Figure 2 is used to generate engineering unit conversion for time-domain plasma wave signals.

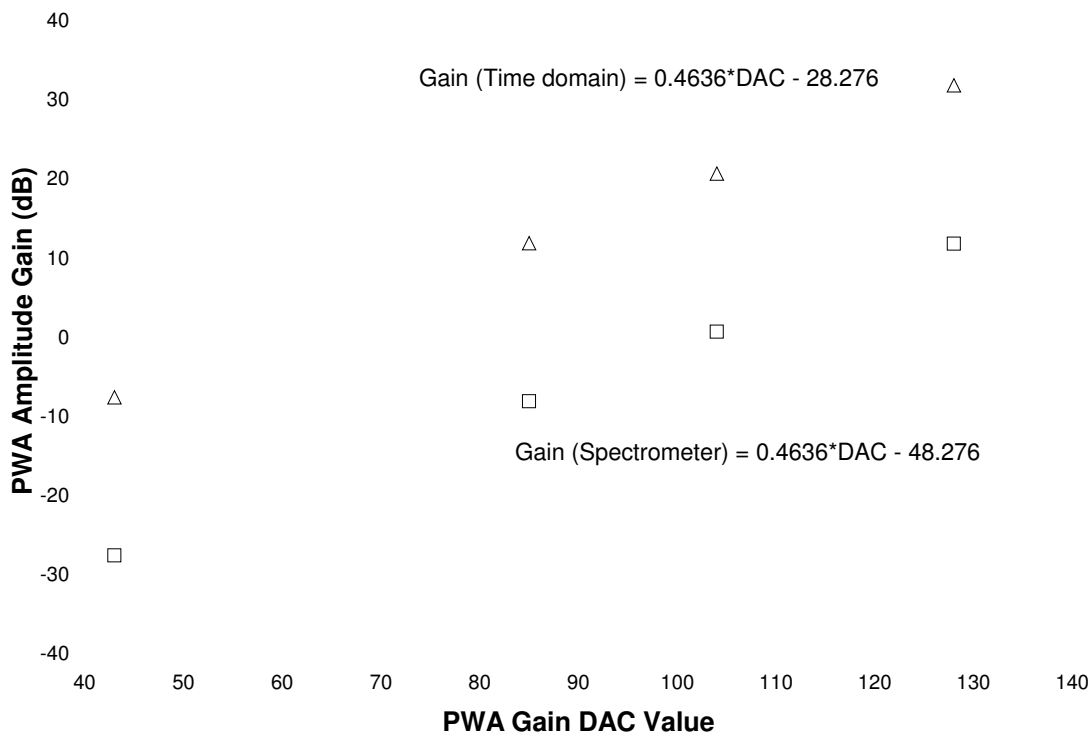

Figure 2. Response of the PWA voltage-controlled gain pre-amplifier

The SCM sensor was separately calibrated in a magnetometer calibration facility (mu-metal shielded housing and known solenoid magnetic field source) to provide Volts/Tesla response over the nominal frequency range (7 Hz to 25.6 kHz) as shown in Figure 3. For B-field time-domain measurements, the engineering unit conversion factor was taken to be 40,000 V/T.

Variable-gain for the SCM sensors was achieved via a voltage-controlled amplifier within the PWS circuit board. The SCM signal was amplified and then routed to both the spectrometer and the time-domain signal chains. The time-domain signal chain (BRAWout) includes a low-pass (10 kHz) filter with an additional 20 dB gain. The voltage-controlled amplifier response function for the SCM is shown in Figure 4.

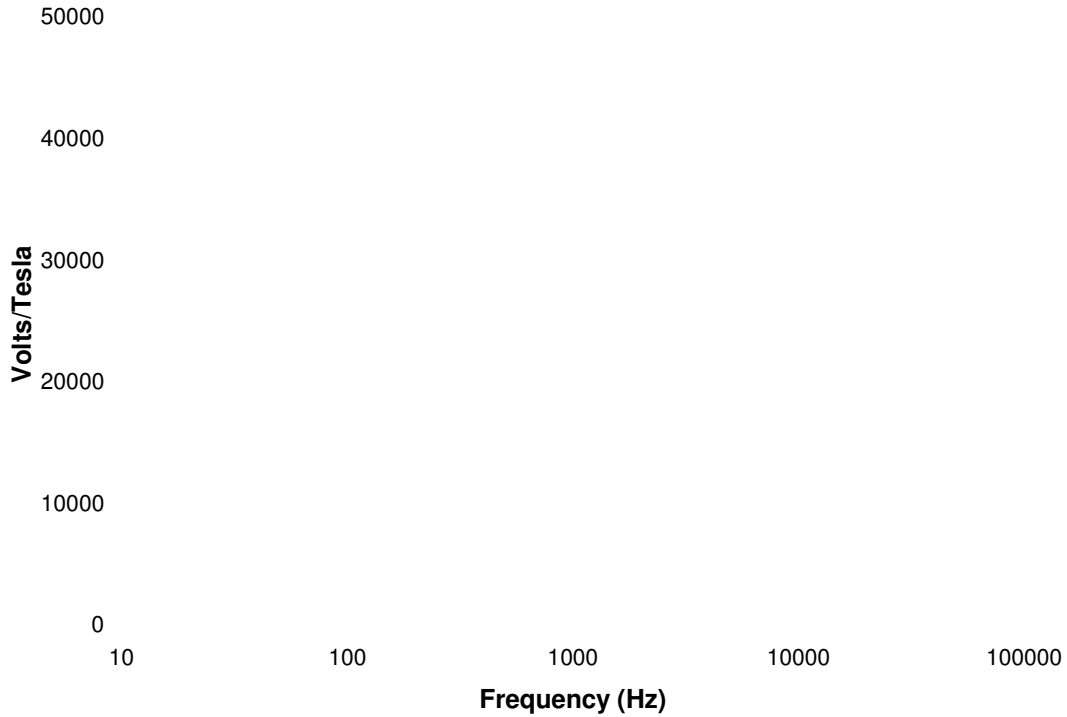

Figure 3. Calibration curve for IDS miniature Search Coil Magnetometer

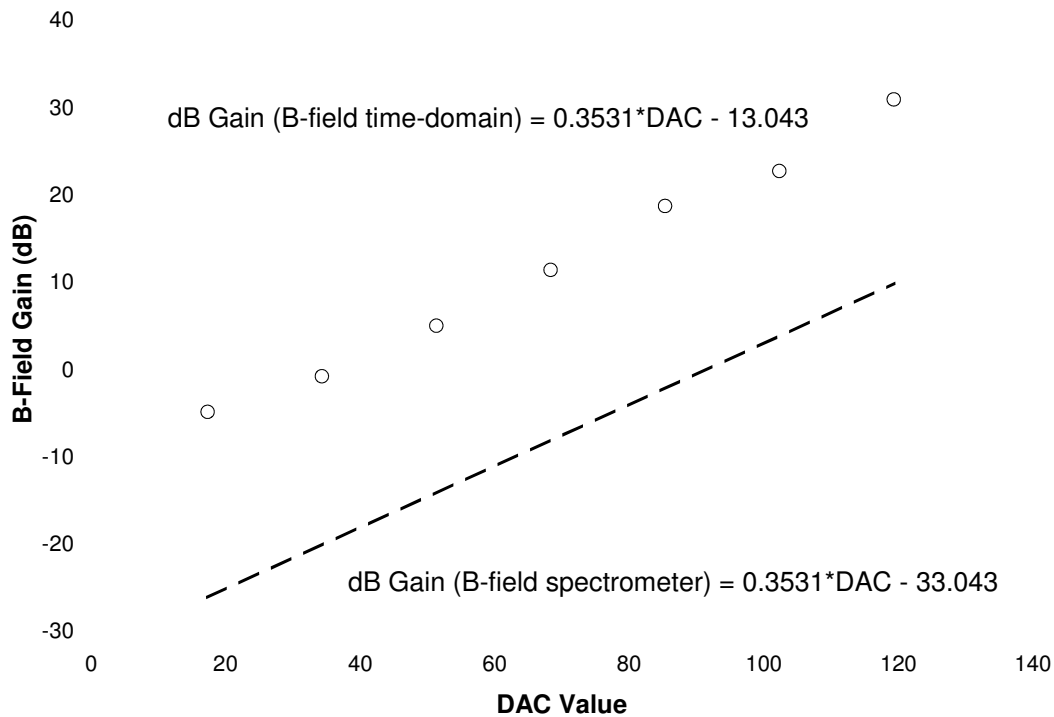

Figure 4. Response of the SCM voltage-controlled gain pre-amplifier.

Plasma Wave Spectrometer Calibration

Calibration of the PWA (E-field) and SCM (B-field) sensor spectrometer channels for the IPS Diagnostics Sensors (IDS) were performed with the flight hardware during final thermal testing. The low-frequency E-field and B-field spectrometer channels are derived from voltage-controlled fourth-order band-pass filters with constant Q. Calibration signals were injected directly into the PWA dipole antenna leads at the pre-amp and the external SCM channel inputs shown in Figure 1. The calibration activity described herein was intended to characterize the center frequency, bandwidth and sensitivity of the IDS spectrometer channels.

The IDS spectrometer channel calibration was performed over the operating temperature range (-25C to +50C). At elevated temperatures (>40C), internal oscillation was observed in the 400 Hz to 700Hz frequency in the spectrometer board. Fortunately, the IDS spectrometer board remained below +25C throughout most of the DS1 mission, and was approximately 15C during the Comet Borrelly encounter. Very little sensitivity to temperature was observed during calibration over the temperature range of -25C to +25C, thus only the +25C calibration data set was analyzed to produce the engineering unit conversions for the spectrometer channels.

Characterization of the spectrometer channels was performed by injecting sinusoidal signals of known frequency and amplitude into the spectrometer inputs. For frequency response characterization, the input amplitude was held constant (100 mV peak-to-peak) and the injected signal frequency was varied stepwise from 1 Hz to 50 MHz in logarithmic fashion. A few channels were characterized with higher frequency resolution to verify the response of tunable band-pass circuit. The frequency characterization data for Channel 7 (E-field, 780 Hz) is accurately fit by a fourth-order band-pass filter response function as shown in Figure 5. The band-pass filter response functions for the 16 low-frequency E-field channels are show in Figure 6 with the best-fit characteristic parameters listed in Table 1.

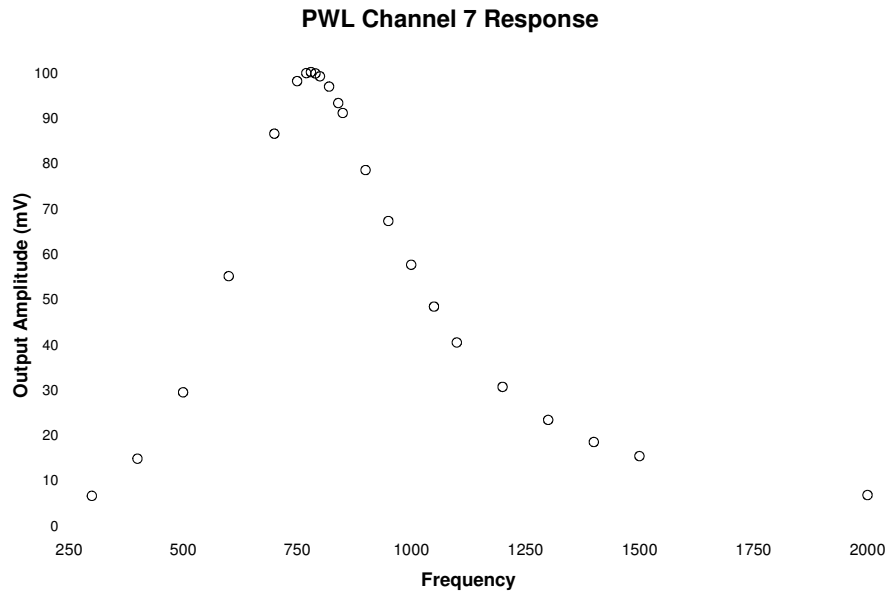

Figure 5. Response function for a typical IDS E-field spectrometer channel

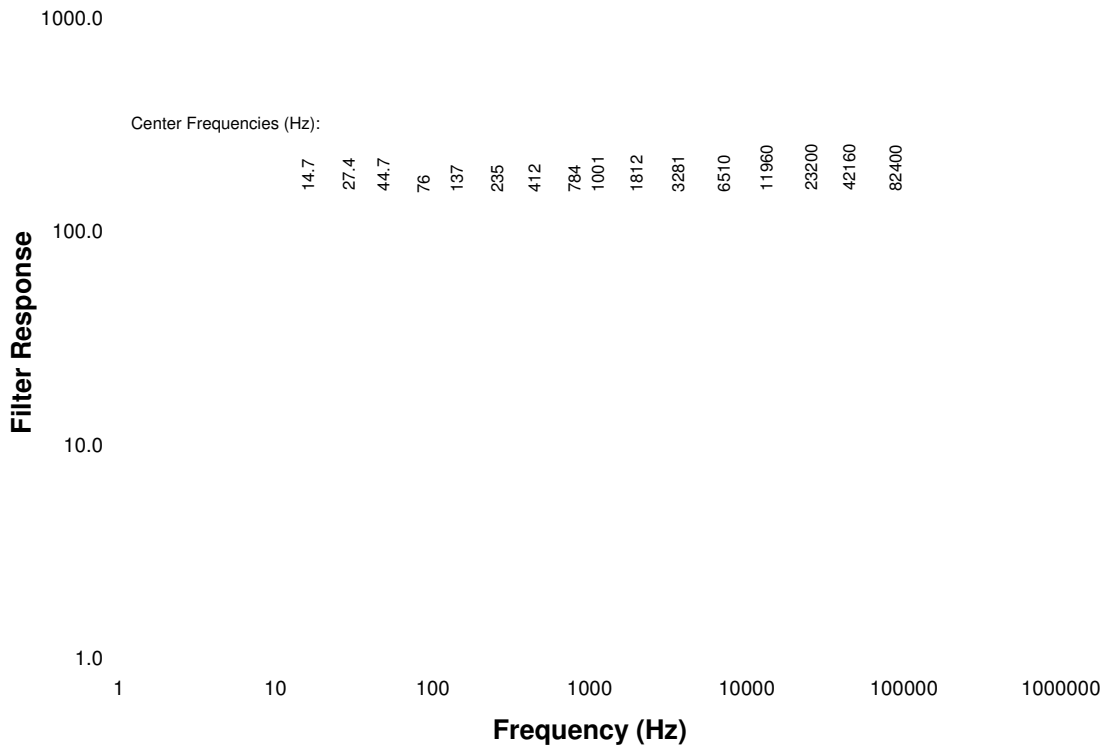

Figure 6. Filter response for IDS PWS E-field low-frequency channels.

Table 1. IDS PWS E-Field (PWA) Low-Frequency Channel Characteristics

Channel	Center Frequency (Hz)	Bandwidth (Hz)	Q	Gain Compensation
0	15	10	1.5	34.5
1	28	16	1.8	8.4
2	45	26	1.8	4.4
3	76	23	3.3	1
4	137	76	1.8	1.25
5	235	131	1.8	1
6	412	238	1.7	1.1
7	784	450	1.7	1
8	1001	572	1.8	0.99
9	1812	1018	1.8	0.99
10	3281	1854	1.8	0.99
11	6510	3657	1.8	0.945
12	11960	6757	1.8	1
13	23200	13260	1.8	1
14	42160	24800	1.7	1
15	82400	49000	1.7	1

The modeled response functions for the 8 high-frequency E-field channels are plotted in Figure 7 with the best-fit parameters listed in Table 2. Two of the high-frequency channels exhibit anomalous behavior as will be described presently. When tested as a stand-alone board, PWS high-frequency channels 5 and 6 had center frequencies near 15 MHz and 7.1 MHz respectively. Subsequent to assembly and environmental test, some form of coupling and large baseline offsets developed for these channels (now the apparent center frequencies are near 13 MHz and channel 6 is best fit by two second-order filters). Also in reviewing the calibration data we found that approximately 40% of the amplitude of signals in the 34MHz channel are coupled into the two ~13MHz channels. Due to the late discovery of these issues and a tight delivery schedule for the hardware, the source of these anomalies could not be investigated. The high-frequency channels above 1 MHz are of little scientific interest for the comet encounter, but were valuable for measurement of plasma noise produced by the DS1 ion engine.

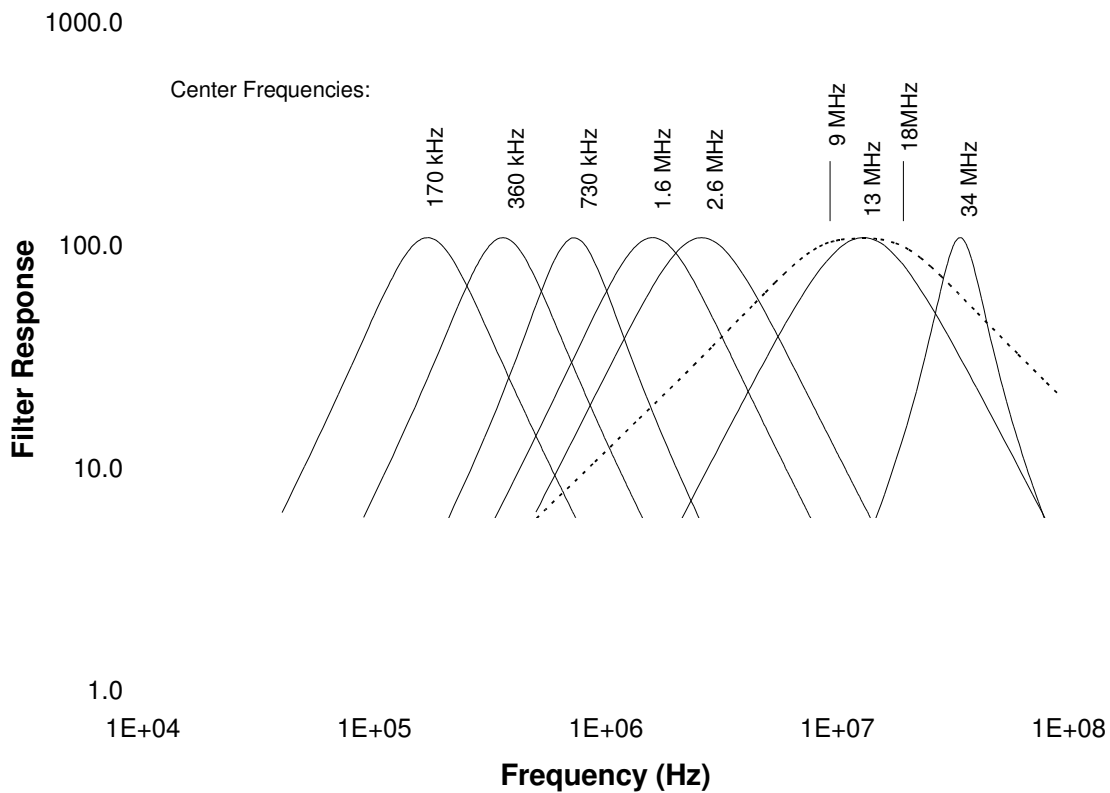

Figure 7. Filter response for IDS PWS E-field high-frequency channels.

Table 2. IDS PWS E-Field (PWA) High-Frequency Channel Characteristics



Channel	Center Frequency (Hz)	Bandwidth (Hz)	Q	Gain Compensation
0	170k	170k	1	0.9
3	360k	327k	1.1	0.55
2	730k	561K	1.3	0.58
4	1.6M	1.8M	0.9	3.2
7	2.6M	3.3M	0.8	2
6	13.5M*	32M	*	1.75
5	13M	18.6M	0.7	6.2
1	34M	15.5M	2.2	0.8

\* Channel six is best-fit with two second order band path filters with their two center frequencies at 9MHz and 18MHz

The spectrometer channels for the search coil (B-field) sensor were also characterized during IDS calibration. Response functions for the 16 low-frequency channels were determined by injecting signals from a function generator directly into the search coil voltage inputs of the PWS board. The conversion factors from voltage to B-field (Figure 3) for each channel were taken at the center frequency and are listed with the other B-field spectrometer channel characteristics in Table 3.

Table 3. IDS PWS B-field (Search Coil) Low-Frequency Channel Characteristics

Channel	Center Frequency (Hz)	Bandwidth (Hz)	Q	Gain Adj	Pre-amp Scale Factor pT/V
0	14	8	1.6	17.5	9.713E8
1	28	15	1.8	5.8	2.888E8
2	44	24	1.8	3.15	1.314E8
3	77	26	3	1	4.080E7
4	131	65	2	1.16	4.652E7
5	223	106	2.1	0.95	3.620E7
6	408	227	1.8	1	3.630E7
7	767	426	1.8	1	3.260E7
8	1000	556	1.8	1.	3.110E7
9	1800	1000	1.8	1	2.785E7
10	3300	1833	1.8	1	2.700E7
11	6505	3614	1.8	1	2.530E7
12	11900	6611	1.8	1	2.595E7
13	23000	12778	1.8	1	3.336E7
14	43200	24000	1.8	1	1.483E8

15	81800	45444	1.8	0.99	4.069E8
----	-------	-------	-----	------	---------

### Amplitude Response Function

Amplitude response characterization was performed at constant frequency (2 kHz) while increasing the input amplitude from 1 mV to 1 V (peak-to-peak). The AGC detector circuit has an active “log-linear” region and highly non-linear response at amplitude extremes (<30 mV or > 3V peak-to-peak). Since transient events can easily saturate the detection circuit, a substantial amount of spectrometer data has been recorded using low gain at the pre-amp stage. A significant effort was taken to characterize the low-end response of the IDS PWS. The amplitude response for the low-frequency PWS (E-field) is shown in Figure 8. Similar amplitude sweeps were performed for the high-frequency PWS(E-field) as shown in Figure 9 and the search coil (B-field) spectrometer as shown in Figure 10

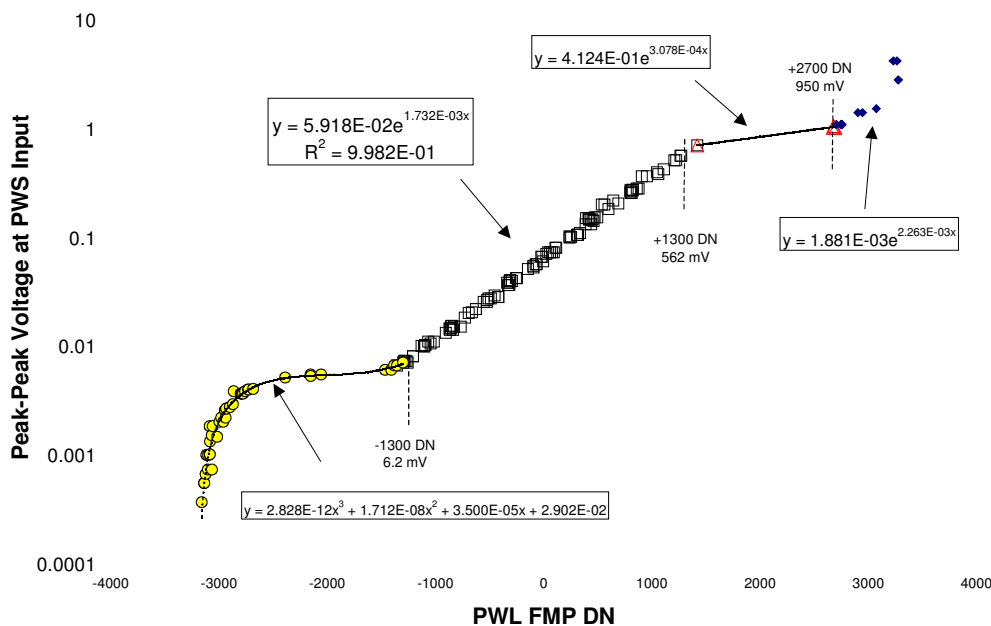

Figure 8. Amplitude conversion for IDS low-frequency E-field spectrometer.

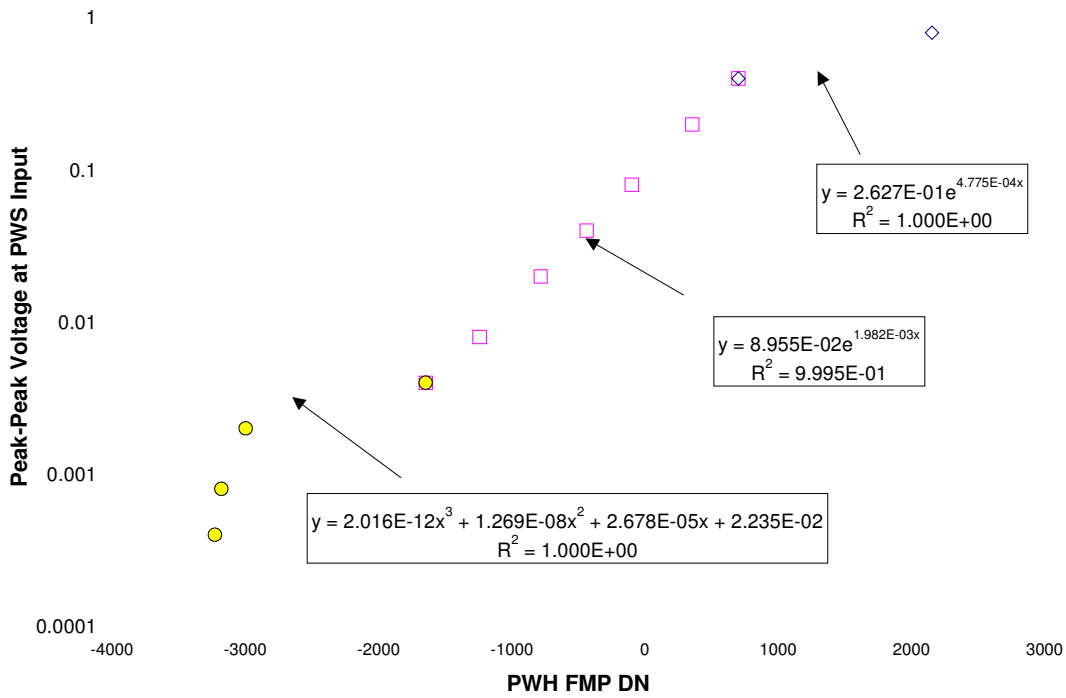

Figure 9. Amplitude conversion for IDS high-frequency E-field spectrometer.

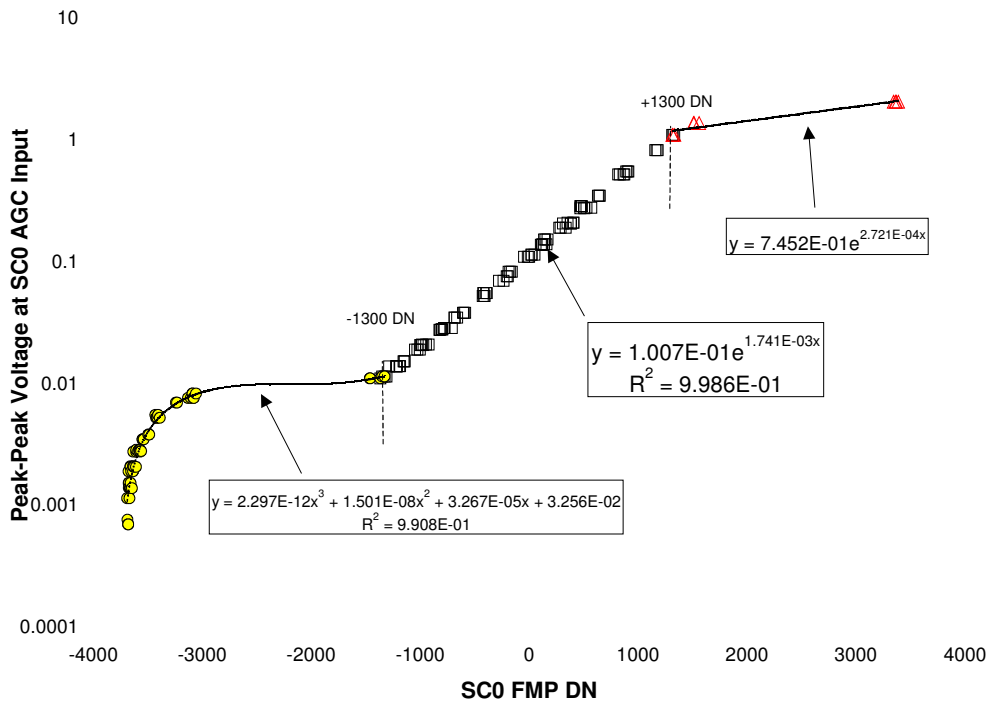

Figure 10. Amplitude conversion for IDS low-frequency B-field spectrometer.