

New Horizons SOC to Instrument Pipeline ICD

July 2014

SwRI® Project 05310

Document No. 05310-SOCINST-01

Contract NASW-02008

Prepared by



SOUTHWEST RESEARCH INSTITUTE®

Space Science and Engineering Division
6220 Culebra Road, San Antonio, Texas 78228-0510
(210) 684-5111 • FAX (210) 647-4325

***New Horizons* SOC to Instrument Pipeline ICD**

SwRI Project 05310

Document No. 05310-SOCINST-01

Contract NASW-02008

Prepared by: Joe Peterson
Revised by: Brian Carcich

08 November 2013
August, 2014

Contributors:

ALICE specifics prepared by: Maarten Versteeg, Joel Parker, & Andrew Steffl
LEISA specifics prepared by: George McCabe & Allen Lunsford
LORRI specifics prepared by: Hal Weaver & Howard Taylor
MVIC specifics prepared by: Cathy Olkin
PEPSSI specifics prepared by: Stefano Livi
REX specifics prepared by: Ivan Linscott & Brian Carcich
SDC specifics prepared by: David James
SWAP specifics prepared by: Heather Elliott

Space Science and Engineering Division
Southwest Research Institute
P. O. Drawer 28510
6220 Culebra Road
San Antonio, Texas 78228-0510
(210) 684-5111

General Approval Signatures:

Approved by: _____ Date: _____
Hal Weaver, JHU/APL, Project Scientist

Approved by: Leslie Young via email 1 December 2005
SwRI, Deputy Project Scientist

Approved by: John Andrews via email 4 December 2005
SwRI, SOC Project Manager

Instrument-specific Signatures:

(Science Theme Teams members)

Approved by: _____ Date: _____
Jeff Moore, NASA, GGI Science Theme Team Lead
(applies to MVIC, LORRI)

Approved by: /s/ Dale Cruikshank via email 6 March 2006
NASA, COMP Science Theme Team Lead
(applies to LEISA)

Approved by: Randy Gladstone via email 6 December 2005
SwRI, ATM Science Theme Team Lead
(applies to ALICE, REX)

Approved by: /s/ Fran Bagenal via email 23 January 2006
CU, P&P Science Theme Team Lead
(applies to SWAP, PEPSSI, SDC))

Space Science and Engineering Division
Southwest Research Institute
P. O. Drawer 28510
6220 Culebra Road
San Antonio, Texas 78228-0510
(210) 684-5111

(Instrument PIs & Scientists)

Approved by: Alan Stern via email 5 December 2005
SwRI, ALICE Instrument PI

Approved by: Dave Slater via email 2 December 2005
SwRI, ALICE Instrument Scientist

Approved by: Alan Stern via email 5 December 2005
SwRI, ALICE Instrument PI

Approved by: Dennis Reuter via email 5 December 2005
NASA, LEISA Instrument Scientist

Approved by: _____ Date: _____
Andy Cheng, JHU/APL, LORRI Instrument PI

Approved by: _____ Date: _____
Hal Weaver, JHU/APL, LORRI Instrument Scientist

Approved by: Alan Stern via email 5 December 2005
SwRI, ALICE Instrument PI

Approved by: Dennis Reuter via email 5 December 2005
NASA, LEISA Instrument Scientist

Space Science and Engineering Division
Southwest Research Institute
P. O. Drawer 28510
6220 Culebra Road
San Antonio, Texas 78228-0510
(210) 684-5111

Approved by: _____ Date: _____
Ralph McNutt, JHU/APL, PEPSSI Instrument PI

Approved by: _____ Date: _____
Stefano Livi, JHU/APL, PEPSSI Instrument Scientist

Approved by: /s/ Len Tyler via email Date: 8 March 2006
Stanford, REX Instrument PI

Approved by: /s/ Ivan Linscott via email Date: 8 March 2006
Stanford, REX Instrument Scientist

Approved by: _____ Date: _____
Mihaly Horanyi, CU, SDC Instrument PI

Approved by: _____ Date: _____
Mihaly Horanyi, CU, SDC Instrument Scientist

Approved by: Dave McComas via email Date: 12 December 2005
SwRI, SWAP Instrument PI

Approved by: Heather Elliot via email Date: 8 March 2006
SwRI, SWAP Instrument Scientist

Release to Document Control:

Approved by: _____ Date: _____
L. D. McCullough, SwRI Project CM

Space Science and Engineering Division
Southwest Research Institute
P. O. Drawer 28510
6220 Culebra Road
San Antonio, Texas 78228-0510
(210) 684-5111

TABLE OF CONTENTS

	Page
1. SCOPE.....	1
2. SIGNATURES, AUTHORSHIP, AND RESPONSIBILITY	1
3. APPLICABLE DOCUMENTS.....	1
3.1 New Horizons Documents.....	1
4. INTRODUCTION.....	1
5. INTERFACE DESCRIPTION.....	2
6. REQUIREMENTS.....	3
6.1 Level 2 (output) Files.....	3
6.2 Pointing Information.....	4
6.3 The Code.....	4
6.4 Calibration Data.....	5
6.5 Documentation.....	5
6.6 Error Conditions and Integration Troubleshooting.....	5
6.7 PDS Archiving.....	6
6.8 Configuration Management.....	6
6.9 Pipeline Updates.....	6
6.10 Acceptance Review.....	6
6.11 Longevity.....	6
7. ALICE INSTRUMENT DESCRIPTION.....	7
7.1 Overview.....	7
7.2 “Raw” Data Specifics.....	7
7.3 “Calibrated” Data Specifics.....	13
8. LEISA INSTRUMENT DESCRIPTION.....	18
8.1 Overview.....	18
8.2 Raw Data Specifics.....	19
8.3 Calibrated Data Specifics.....	22
9. LORRI INSTRUMENT DESCRIPTION.....	29
9.1 Overview.....	29
9.2 Raw image Specifics.....	30
9.3 Calibrated Image Specifics.....	33
9.4 References.....	50
10. MVIC INSTRUMENT DESCRIPTION:.....	52

10.1 Overview.....	52
10.2 Level 1 Specifics.....	55
10.3 Level 2 Specifics.....	59
11. PEPSSI INSTRUMENT DESCRIPTION.....	69
11.1 Overview.....	69
11.2 Introduction to PEPSSI Data.....	71
11.3 Level 1 Specifics.....	73
11.4 Level 2 Specifics.....	74
12. REX INSTRUMENT DESCRIPTION.....	105
12.1 Overview.....	105
12.2 Raw Data Specifics.....	107
12.3 Calibration Specifics.....	114
13. SDC INSTRUMENT DESCRIPTION.....	118
13.1 Overview.....	118
13.2 Raw Data Specifics.....	118
13.3 Calibration.....	121
13.4 Calibrated Data Specifics.....	124
14. SWAP INSTRUMENT DESCRIPTION.....	128
14.1 Overview.....	128
14.2 Electronics and Flight Software.....	130
14.3 SWAP Data Types.....	130
14.4 Raw File (Level 2) Specifics.....	132
14.5 Calibrated (Level 3) File Specifics.....	134
14.6 Operations.....	143
14.7 Observation Examples.....	143
14.8 Updates to the Level 3 Calibrated SWAP Data Pipeline.....	148
14.9 Gain and Deflector Angle Sweep Tests.....	148
14.10 SWAP Science Goals.....	149
14.11 SWAP Publications To Date.....	151
14.12 Packet Description.....	152
15. ACRONYMS AND ABBREVIATIONS.....	157

REVISION NOTICE

Draft 1: October 2005
Draft 2: February/March 2006
Initial Issue: February 2007. Updated Sections 10 (MVIC), 11 (PEPSSI), 13 (SDC) and 14 (SWAP).
2014-08: August, 2014 Updated many sections for PDS deliveries

1. SCOPE

This document specifies the interfaces between the *New Horizons* Science Operations Center (SOC) and the instrument pipeline, which process data from Level 1 to Level 2. The purpose is to define the various aspects of the interfaces in sufficient detail to establish a clear understanding between the SOC and the instrument team to allow for a parallel pipeline development.

2. SIGNATURES, AUTHORSHIP, AND RESPONSIBILITY

This document is unusual in that many parties took part in its writing. Specifically, sections 1 through 6 were written by the document author, whereas the bulk of the instrument-specific sections (7 through 14) were written by representatives of the instrument described. Because of this, a few words will be said regarding signatures.

Each instrument team will have a person or persons responsible for their section. If changes are made to that section, only the person(s) responsible need to sign the new revision. If, however, changes are made to sections 1 through 6, all parties need to sign. The title(s) of the person(s) responsible for each instrument section are given in the signature section above.

The *New Horizons* project maintains a copy of the signed version of this document under Configuration Management (CM); from 2008 through 2014, a fork of this document has been edited many times as a support document for PDS data set deliveries and the signatures no longer apply.

3. APPLICABLE DOCUMENTS

3.1 *New Horizons* Documents

- *New Horizons* SOC Data Pipeline Guide (SwRI Doc. No. 05310-SOCPL-G-01)
- *New Horizons* SOC Level 1 Data Formats (SwRI Doc. No. 05310-SOCL1DATA-01)
- *New Horizons* SOC Pipeline User Manual (SwRI Doc. No. 05310-SOCPLUM-01)
- *New Horizons* Data Management and Archiving Plan (SwRI Doc. No. 05310-DMAP-01)
- *New Horizons* Longevity Plan (APL Doc. No. 7399-9009)
- Definition of the Flexible Image Transport System (FITS)
(ftp://legacy.gsfc.nasa.gov/fits_info/fits_office/fits_standard.pdf)

4. INTRODUCTION

The *New Horizons* SOC is part of the ground system that processes data returned from the *New Horizons* planetary spacecraft. Data downlinked from the spacecraft in raw packetized form is retrieved by the SOC from the Mission Operations Center (MOC) along with navigation and related ancillary data. The SOC generates the higher level (more refined) data products used by the instrument teams and science teams. In addition, the SOC performs archiving of data (but not data products, such as maps) to the Planetary Data System (PDS). The science data processing component of the SOC is called the SOC pipeline. The Level 2 pipeline (called the “instrument pipeline” and also known as the “calibration pipeline”) software is a segment of the SOC Pipeline. The instrument pipeline for each instrument is written by the appropriate instrument team. It is run on the SOC processing station to transform Level 1 decommutated data into Level 2 calibrated science data. The instrument pipeline creates PDS standard, Level 2 provisional products in Flexible Image Transport System (FITS) format, which is described in the document referenced herein (Definition of the Flexible Image Transport System).

The SOC pipeline is divided into two main parts: the Level 1 pipeline segment and the Level 2 (instrument) pipeline segment. Pipeline processing is carried out sequentially. Results of the Level 1 pipeline are provided as inputs to the instrument Level 2 pipeline segment. More information about the formats of Level 1 data can be found in the “*New Horizons* SOC Level 1 Data Formats” document (SwRI Doc. No. 05310-SOCL1DATA-01). The instrument pipeline generates Level 2 results that the SOC forwards to the PDS archiving process. Level 1 data is also archived to the PDS.

The SOC obtains science data from the Mission Operations Center (MOC) through automated network transfers. Low-speed housekeeping and high-speed science data from the spacecraft are provided in packetized Supplemented Telemetry Packet (STP) form. Navigation data, ephemerides and spacecraft pointing information, is provided in SPICE format from the MOC and is used in Level 1 processing. Upon getting packets (housekeeping and science data) from the MOC, the data is decommutated in the SOC and written to an SQL database. Housekeeping from the database and science data are associated by MET time and other methods, such as by using meta data inserted in the high-speed telemetry. Data for an observation are combined to create the Level 1 uncalibrated data file. A PDS detached header file (a separate file containing the PDS header with a pointer to the data file itself) is also created for each file. The header of the Level 1 file contains most of the necessary information about the particular observation needed by the instrument pipeline (an exception is detailed pointing, which will be calculated during calibration). The instrument pipeline segment creates the Level 2 calibrated data file from the contents of the Level 1 file and calibration data provided by the instrument team. Level 1 and Level 2 science data files are stored in FITS format. Lastly, the SOC archives pipeline data products to the PDS.

SOC pipeline processing is automated under the control of the Master Data Manager (MDM), which is a collection of scripts that control the flow of the pipeline. While manual execution of the program is permitted, normal operation of the SOC pipeline is not directed by manual requests or user inputs. Pipeline segments are called by the MDM when data from the MOC or from a previous pipeline step is available.

The hardware platform used for the SOC as implemented for launch and early mission is an Intel Pentium 4 processor running at 3.2GHz with 4GB RAM and a 146GB SCSI hard disk. In the case of the primary SOC (TSOC), located in Boulder, Colorado, two of these machines are used (one for pipeline processing and the other for data storage). At the secondary (backup) SOC (CSOC), only one machine is used for both purposes. The operating system used in all cases is Linux. Migration to newer machines compatible with SOC requirements is a possibility during the long flight missions.

5. INTERFACE DESCRIPTION

The SOC pipeline code will call the Level 2 pipeline code by executing a separate process. The name of the executable or script shall be:

[instrument]_level2_pipeline

(where “[instrument]” is the full instrument name (i.e. alice, leisa, lorri, mvic, pepssi, rex, sdc, or swap) in lower case).

The parameters (all are character strings) passed to the Level 2 code will follow the executable name and will be in the following order (note that “full path,” when stated below, means a file specification containing the filename and all directories in the file’s path):

- ***in_file*** - Location of input (Level 1) file (***in_file***)

The SOC will provide the full path of the Level 1 input file to the Level 2 pipeline code.

- ***in_pds_header* - Location of input (Level 1) detached PDS header**
The SOC will provide the full path of the Level 1 PDS header to the Level 2 pipeline code.
- ***calibration_dir* - Location of calibration data and temporary file storage**
Data provided by the instrument team that is needed for calibration shall be supplied by the instrument team. The SOC will provide the root directory containing these files (and potentially, subdirectories) to the Level 2 pipeline code so it references the correct location. The structure of the directories under this directory is up to the instrument team.
- ***temp_dir* - Location for temporary storage used by code**
This is a place where the instrument pipeline code may write files for temporary use. The contents of this directory will be erased upon completion of the instrument pipeline.
- ***out_status* - Location of status file**
The Level 2 pipeline, upon completion, may write a short machine readable status file used to communicate the results of the processing to the main SOC pipeline. The location (full path) of this file will be supplied by the SOC.
- ***out_file* - Location of output (Level 2) file**
This is the file (full path) to which the output will be written. The SOC will provide this to the Level 2 pipeline code.
- ***out_pds_header* - Location of output (Level 2) detached PDS header**
This is the file (full path) to which the Level 2 PDS header will be written. The SOC will provide this to the Level 2 pipeline code.

6. REQUIREMENTS

This section describes the various requirements that the instrument team shall follow with regard to the Level 2 pipelines.

6.1 Level 2 (output) Files

The Level 2 data files shall be FITS files, and there shall be exactly one Level 2 file produced for each Level 1 file (in any given run of the instrument pipeline). The headers will be mostly the same, except for optional additional keywords inserted in the Level 2 files (this could include, for example, refined pointing). In other words, typically, the Level 2 header keywords will be a superset of the Level 1 header keywords.

The filename of the Level 2 file will be supplied by the SOC, and it will be similar to the Level 1 filename. PDS requires a “27.3” ASCII character limit on the filenames, and the format of the names shall be as follows:

- Level 2: *[instrument]_[MET]_[ApID]_sci_[version].fit*

(where “[instrument]” is the first three letters of the instrument name (i.e. ali, lei, lor, mvi, pep, rex, sdc, or swa) in lower case, “[MET]” is the 10-digit MET time, either from the instrument itself (low-speed data) or from the instrument interface card (high-speed data), “[ApID]” is the hexadecimal value of the ApID (Application ID of the main packet used in the data product; also abbreviated as APID in this document and elsewhere) for this observation, and “[version]” is the version stamped on this file based in existing previous versions produced).

The instrument/mode strings above will be derived from the ApID of the data, and these filenames will be supplied to the instrument pipeline (see the interface description above).

- Level 1: ***[instrument]_[MET]_[ApID]_eng_[version].fit***

Whereas the Level 1 files will be in the same "units" as the data coming from the spacecraft/instrument (i.e. same binary representation - this is partly to avoid any round-off or conversion loss), the Level 2 files shall express values in physical units useful for scientific interpretation.

Whereas the Level 1 files only contain the header and data itself, the Level 2 files shall contain (when appropriate) two additional "panes" (FITS extensions):

- Error (specifies error bars on the numbers – defined by the instrument team)
- Quality (Indicates the quality of the data – defined by the instrument team)

If it is desired to re-run the Level 2 pipeline (because of new Level 2 code or calibration data), a new version of the output file will be named as specified above when calling the Level 2 pipeline.

6.2 Pointing Information

The pointing information included in the Level 1 files will be mostly non-instrument specific (except for bore-sight vector where applicable). It also may not cover the time granularity needed for calibration in the Level 2 pipelines (see the “*New Horizons SOC Level 1 Data Formats*” document (SwRI Doc. No. 05310-SOCL1DATA-01) for specifics). Therefore it is expected that the Level 2 pipelines may have to make use of SPICE. It is therefore the responsibility of the Level 2 pipelines to provide this functionality. SPICE kernels will be available on the SOC.

6.3 The Code

The SOC defines the interface the code uses to access the required data. This includes the directory structure on the disk where the Level 1 data file can be found as well as the path (specific to each instrument) where instrument-team-supplied calibration files and other data will be stored and accessed. Also, the filename of the output file is supplied.

The code shall be written in a language that meets the SOC's longevity requirements (see section 6.11). More information on this can be found in the “*New Horizons SOC Pipeline Guide*” (SwRI Doc. No. 05310-SOCPL-G-01). The languages allowed are as follows:

- C
- C++
- Fortran
- IDL

- Python
- Java
- Perl

The code written by the instrument team shall not implement very time consuming iterative numerical processing to the extent that it has an impact on the daily processing done by the SOC. In other words, if the time to compute Level 2 data is so extreme that it jeopardizes the completion of each daily run of the pipeline (so ample idle time is not available between runs), the situation will need to be re-evaluated. It is expected that a daily run of the entire pipeline be complete within a few hours of its start. This gives most of the day for users to access new data before the next run is initiated. The maximum time allowed for execution of an instrument's Level 2 pipeline shall be **5 minutes** (for each input file processed). The predicted actual maximum time is negotiated and specified in the instrument-specific sections.

Any needed 3rd party libraries also shall meet the longevity requirements. Specifically, source code should be available and must be provided with the code unless already available to the SOC.

6.4 Calibration Data

The code will most likely need calibration data in addition to the Level 1 data files themselves. This data can be anything required. The SOC will provide a directory where these files will be placed on the SOC pipeline system, and the instrument pipeline code will be able to access them there.

The combination of the Level 1 file (and detached PDS label) and the data provided must be sufficient to produce each Level 2 file. If housekeeping information (instrument or spacecraft) is needed, these must be already in the header (or tables) of the Level 1 file. If continuously varying values (e.g. temperature over many seconds, etc.) are needed, a FITS table will be written into the Level 1 file with this information.

6.5 Documentation

All code and data files shall be accompanied by thorough documentation. The code itself should have clear and appropriate comments throughout. Error conditions shall be documented in the code as well (see section 6.6 for more on this topic).

Documentation and code shall be written assuming that it will be read by someone years from now who is unfamiliar with the system. Understanding of the documentation should not rely on special scientific knowledge or specific domain knowledge.

6.6 Error Conditions and Integration Troubleshooting

If there are any reasons the code might abort processing, these shall be defined, and the resulting action should be specified. Also, if such an abort happens, the reason should be noted in the status file written ("out_status" file described above).

A contact person shall be specified who will be responsible for helping the SOC operators when unexpected errors occur. This person should be able to help with debugging and should also be available to respond and help in two days or less for consultation during the pipeline integration process.

6.7 PDS Archiving

The Level 2 (output) files, as well as Level 1 files, will be archived to PDS. Therefore the format of the files shall meet PDS requirements. This includes size requirements set forth in the *New Horizons* Data Management and Archiving Plan (#05310-DMAP-01).

PDS detached labels for the Level 2 files shall be generated by either the instrument pipeline code or by the SOC using a translation table (from FITS to PDS keywords). Which method is appropriate will be determined on an instrument by instrument basis. If generated by the SOC, “in_pds_header” and “out_pds_header” can be ignored in the instrument pipeline code.

6.8 Configuration Management

All code, documentation, and calibration files will be put under configuration management at the SOC. Also, the necessary keywords shall be inserted into the Level 2 headers by the Level 2 pipeline code to specify the version of the code and data used to produce the Level 2 files. This ensures that data is traceable back to the correct code version.

In addition, the Level 2 pipeline code shall insert, using header keywords, the calibration files used and the versions thereof (if applicable).

6.9 Pipeline Updates

Updates to the instrument pipeline (including code, documentation, and calibration data) are to be delivered to SOC personnel for integration; all such updates will require appropriate documentation and will fall under SOC CM. The code will be checked in to the SOC configuration management after regression tests are run. Any special instructions or changes should be communicated to the SOC personnel, and a file containing release notes (called “RELEASE_NOTES”) should accompany the update. The SOC personnel will notify the instrument team when the new update is in place and active.

6.10 Acceptance Review

The instrument pipeline (including code, documentation, and calibration data) shall be subject to an acceptance review.

6.11 Longevity

The code and all third party libraries and data files used shall meet the longevity requirements as specified in the *New Horizons* Longevity Plan (#7399-9009). Also, development, documentation, and testing of the pipeline shall adhere to these requirements.

7. ALICE INSTRUMENT DESCRIPTION

7.1 Overview

PERSI-Alice is a UV spectrograph that is sensitive to Ultraviolet (UV) light in the range of 520-1870 Å. The instrument consists of a telescope section with an off-axis parabolic mirror, and a spectrograph section that includes a diffraction grating and a microchannel plate (MCP) detector. The MCP detector is an electro-optical device sensitive to extreme and far ultraviolet light and energetic particles. It consists of a photo cathode-coated MCP surface that converts UV photons to electrons, an MCP Z-stack configuration of three MCPs to amplify the signal, and a two-dimensional double delay-line (DDL) anode readout array. The first (x) dimension provides the spectral location of the detected photon and the second (y) dimension provides one-dimensional spatial information. The DDL detector system outputs to the command-and-data-handling (C&DH) electronics the pixel location for each detected photon event. The pixel location (X, Y) is given as a pair of coordinates, spectral (X axis) and spatial (Y axis). The events are processed by the C&DH electronics. The C&DH is also the controller of Alice; it receives commands from the spacecraft, acquires data from the MCP detector system, and returns telemetry to the spacecraft. Science data telemetry generation is performed by the detector hardware but the C&DH also controls this function. Alice has two acquisition modes (see below) in which the spectral/spatial data from the detector are processed by the C&DH subsystem.

All following descriptions assume a nominal operating instrument. The instrument hardware also provides a basic, hardware-controlled, default pixel list acquisition mode, which is activated when the instrument control hardware detects multiple successive software failures. This mode is called the ‘State Machine Mode’ (SMM); for a description of this mode, the reader is referred to the instrument C&DH hardware description. Once this mode is activated any software control of the acquisition operation is disabled, until the instrument C&DH is reset either by a power cycle reset or by a hardware S/C reset.

Data recorded on New Horizons are sent to the ground via the Deep Space Network. From there the data are sent to the Mission Operations Center (MOC) at the Applied Physics Laboratory (APL). The Science Operations Center (SOC) at the Southwest Research Institute (SwRI) in Boulder retrieves new data from the MOC daily. The data from the MOC are in a packetized form. Software pipelines at the SOC convert the data from these raw packets into FITS (Flexible Image Transport System) format files with scientifically useful and calibrated data. The initial processing sorts the packets into FITS files (as images and data tables) with useful header keywords. These keywords include the mode of the observation, exposure and timing information, and basic pointing information of the instrument boresight. The initial processing also adds relevant housekeeping telemetry (temperatures, voltages, etc.) in a binary table as an extension to the FITS file. The calibration pipeline then performs basic scientific calibration on these data.

7.2 “Raw” Data Specifics

The term “raw” as used here refers to CODMAC Level 2 data

7.2.1 Data Format

P-Alice High Speed data frame formats:

Science data frames consist of “raw” science data of 32768 16-bit words in size, consisting of 1 word (16 bits) of frame ID header information and a 32767-word data block. Science data frames are generated by the acquisition hardware and sent to the spacecraft via the dedicated LVDS interface. Data are transferred

at a rate of 1 Mbit/sec, resulting in a frame transfer time of 557 milliseconds. The spacecraft tags the received data with a receive time (referred to as ‘collect time’) and stores the data in the Solid State Recorder (SSR). Note that these science frames are not identical to the CCSDS (Consultative Committee for Space Data Systems) telemetry packets that are used to transfer the science data to the ground. The generation of telemetry (TM) packets from the frames stored in the SSR is handled by the spacecraft and multiple CCSDS TM packets are used to transfer a single science frame.

To identify the Science frames, a single 16-bit word header is inserted into each frame. This header is generated by the acquisition hardware and includes the information listed in Table 10-7. The complete header word of the most recently generated science frame is included in the housekeeping TM packet to allow for correlation between the two data streams (low and high speed) after the data are received by the ground system.

Field	Size in bits	Description
Packet contents (msb)	1	0 - pixel list 1 - histogram
Memory	1	0 - ping (side A), 1 - pong (side B)
Last block	1	0 - intermediate block 1 - last block (acquisition cycle terminated)
HW acquisition	1	HW controlled acquisition (hardware “limp along”, a.k.a. “State machine Mode”), overrides software control after 8 consecutive watchdog timeouts (see C&DH hardware documentation).
Block number	12	Least significant 12 bits of the block number

Table 7-1: PERSI-Alice Science packet telemetry header

The contents of the remainder of the data frames (the 32767-word data block) depend on the acquisition mode:

- Pixel List** Each word in the data block from a pixel list exposure describes a photon event or a time hack. Photon events are indicated by bit 15 having a value of zero and time hacks are indicated by bit 15 having a value of one. For a photon event, the remaining 15 data bits encode the location of the detected event consisting of a 10-bit encoded spectral location (X) and a 5-bit encoded spatial location (Y). The time hack is used to provide temporal information about the photon events. The acquisition hardware will generate and insert time hacks in the frame on a periodic basis; the frequency of the time hacks is configurable (by command) for each acquisition in a range of 4 – 512 ms. For a time hack, the remaining 15 bits contain an incrementing counter that counts the number of 4 ms periods. This value allows for verification and correction of timing in case of lost frames or packets.
- Histogram** Each word in the data block from a histogram exposure is a 16-bit “counter” giving the number of photon events detected at each specific X,Y location on the detector. The format of the detector is 1024x32 pixels, which are the spectral and spatial dimensions respectively, i.e., there are 1024 spectral elements along the X -axis and 32 spatial elements along the Y -axis, giving a total of 32768 values (however, the first word always contains the header word). The counters are stored row-wise, corresponding to the spectral dimension indexing most quickly. These counters saturate at a maximum value of 65535 to indicate a completely filled counting bin, meaning that the counters do not wrap around. In addition some special data words (header cross-identification and pulse height distribution) are overlying the lower left-hand corner of the actual array in a block of 4 (spatial) x 32

(spectral) words. This usage doesn't affect the science data contents because detector events do not occur in this region. In this over-written block, the first row contains the header cross-identification word, the second and third rows contain the 64 words of pulse height information, and the fourth row is filled with zeros. A "pulse height" is the amplitude of a photon event, and this pulse height distribution (PHD) shows the number of events in a 64-bin distribution with 6-bit resolution; the value in each PHD bin gives the number of events that occurred with the particular amplitude associated with that bin. These PHD counters also saturate at a value of 65535. So a single photon event is counted both in the spectral/spatial array and in the pulse height list. The PHD is used as a diagnostic for the health and behavior of the detector.

For test purposes the instrument can fill the memory with known deterministic patterns so the interfaces to the spacecraft and ground can be verified. The instrument software allows for the generation of 5 different test patterns.

7.2.1.1 Histogram FITS file:

The Primary Data Unit (PDU) in the FITS file is a 2-D raw histogram frame (also referred to as an "image") consisting of 1024x32 16-bit integer numbers. Note that the Alice instrument data are unsigned 16-bit integers (giving values of 0 to 65535). Following the PDU is the first Extension Data Unit (EDU), which contains the 64-element pulse height distribution (PHD) that was acquired together with the histogram. When the Level 1 pipeline saves the PHD to this extension, it then zeros out that part of the histogram array. The second data extension contains a 141 column by t row binary table, where t is the time of the exposure in seconds, of housekeeping values recorded during the observation (the housekeeping report rate is 1 Hz).

FITS File Storage Location	Description
Primary Data Unit (PDU)	Raw Histogram image (uncorrected counts)
Extension #1	Pulse Height Distribution (PHD)
Extension #2	Binary Housekeeping Table

7.2.1.2 Pixel list FITS file:

Upon receiving a pixel list frame, the Level 1 processing creates a ground-calculated "reconstructed histogram" from the received pixel list data and places it in the primary data unit of the FITS file; this enables an easy quick-look inspection of the pixel list data (e.g., using most FITS viewers that by default typically display the data in the primary data unit). The pixel list data itself can be hard to interpret, so this reconstructed histogram image is desirable to enable the scientist to determine, e.g., data quality, whether the target was in the field of view, etc... The first data extension contains the raw pixel list data set, which includes the full stream of photon events and time hacks. The second extension contains the derived count rate derived from the pixel list data. Each count rate bin shows the number of events that occurred between successive time hacks. The resolution of this count rate data set is determined by the hack rate used for the pixel list acquisition. The length of this vector is variable depending on the source flux and the hack rate. The third data extension contains a 141 column by t row binary table, where t is the number of housekeeping values recorded during the observation.

FITS File Storage Location	Description
Primary Data Unit (PDU)	Reconstructed Histogram image (uncalibrated counts)
Extension #1	raw pixel list
Extension #2	Count rate vector from pixel list data (sampled at time hack rate)
Extension #3	Binary Housekeeping Table

7.2.2 Data Sources (High/Low Speed, CCSDS, ITF)

PERSI-Alice data are transferred via CCSDS packets that are packetized by the spacecraft from the Solid State Recorder.

The spacecraft will packetize the PERSI-Alice High Speed Telemetry data into CCSDS packets before sending the data to the ground. Different ApIDs (packet Application Process Identifiers; also Application IDs) are used to distinguish the histogram and pixel list data packets (see Table 7-2). For the PERSI-Alice science frames the spacecraft will either use the “RAW” packetized format or the lossless compressed format to transfer the data. In either case the result will be data encoded in CCSDS telemetry packets. The packet ApIDs listed in Table 7-2 are used to distinguish between the different Alice CCSDS packets.

The packet time as listed in the CCSDS packet represents the time at which the packetization operation was performed. The second time field contains the frame collection time as sent from a spacecraft perspective, meaning this represents the time at which the spacecraft received the frame from the instrument. As the instrument immediately sends the frame at the completion of the acquisition this corresponds to the time at which the acquisition was completed. For each data type there are two ApIDs, one for each C&DH (Command and Data Handling) system on the spacecraft.

ApID CDH-1	ApID CDH-2	Data type
0x4B0	0x4B4	Compressed (Lossless) Alice Pixel list Data (DT-1)
0x4B1	0x4B5	Packetized (RAW) Alice Pixel list Data (DT-1)
0x4B2	0x4B6	Compressed (Lossless) Alice Histogram Data (DT-2)
0x4B3	0x4B7	Packetized (RAW) Alice Histogram Data (DT-2)

Table 7-2: PERSI-Alice science ApIDs

Packetized “RAW” telemetry:

The nominal data transfer method for the Alice pixel list science data is packetized “raw” data. Each CCSDS science packet can transfer a segment of up to 480 data bytes. In order to transfer a full PERSI-Alice frame of 32768 words (16-bits), 137 science packets are needed; the first 136 packets will all be full size segments of 480 bytes, the last packet will transfer the remaining 256 bytes. The grouping flags of the packets indicate the start and end segment within a complete frame transfer.

Note the '#' marks in the following tables refer to the third hexadecimal digit of the ApID; valid values for that digit are as indicated in the table captions and in Table 7-2.

Parameter	Bit Count	Size in bytes	Description
Primary Header			
PH_VER_NUM_4B#	3	2	Version Number, fixed value = 0; designates a source packet
PH_PKT_TYP_4B#	1		Type Indicator, fixed value = 0; designates a telemetry packet
PH_SH_FLG_4B#	1		Secondary Header Flag, fixed value = 1; designates presence of secondary header
PH_APP_ID_4B#	11	2	Application Process identifier, see Table 7-2
PH_SEQ_FLG_4B#	2		Grouping Flags: 1 – first segment 0 – intermediate segment 2 – last segment
PH_SEQ_CNT_4B#	14		Source Count, continuous sequence count of all generated packets (per ApID) (modulo 16384)
PH_PKT_LEN_4B#	16	2	Number of bytes (secondary header + data bytes – 1): 511 or 287
Secondary Header			
SH_PACKET_TIME_4B#	32	4	Spacecraft MET at time the Telemetry packet is constructed
SH_COLLECT_TIME_4B#	32	4	Spacecraft MET at time the high-speed science data was collected
Data			
ERROR_STATUS	64	8	Information from the SSR forward error correcting code, not important for simple decoding
SSR_HEADER	128	16	Information from the SSR storage administration, not important for simple decoding
DATA_BLOCK	3840	480	Data bytes, all packets except the last packet 480 bytes, the last one is 256 bytes

Table 7-3: PERSI-Alice CCSDS Packetized (RAW) science packet; # = 1, 3, 5, 7.

Lossless Compressed telemetry:

The nominal data transfer method for the Alice histogram science data is lossless compressed data. When applied to pixel list data, the 'FAST' algorithm results in negligible compression rates, and occasionally in a 1% expansion, therefore lossless compression will generally not be used with pixel list data. The spacecraft uses the so called 'FAST' algorithm to compress the image data. The 'FAST' algorithm uses one-dimensional correlation between successive data elements to remove redundancy. Data is encoded in blocks of 16 successive science values, the first value of such a block is send in full 16 bits, the remainder of the block is encoded using successive differences, using an adaptive coding mechanism.

Parameter	Bit Count	Size in bytes	Description	
Primary Header				
PH_VER_NUM_4B#	3	2	Version Number, fixed value = 0; designates a source packet	
PH_PKT_TYP_4B#	1		Type Indicator, fixed value = 0; designates a telemetry packet	
PH_SH_FLG_4B#	1		Secondary Header Flag, fixed value = 1; designates presence of secondary header	
PH_APP_ID_4B#	11		Application Process identifier, see Table 2	
PH_SEQ_FLG_4B#	2	2	Grouping Flags: 1 – first segment 0 – intermediate segment 2 – last segment	
PH_SEQ_CNT_4B#	14		Source Count, continuous sequence count of all generated packets (per ApID) (modulo 16384)	
PH_PKT_LEN_4B#	16	2	Number of bytes (secondary header + data bytes – 1): maximum 265	
Secondary Header				
SH_PACKET_TIME_4B#	32	4	Spacecraft MET at time the Telemetry packet is constructed	
SH_COLLECT_TIME_4B#	32	4	Spacecraft MET at time the high-speed science data was collected	
Data				
COMP_UNIT_INDICATOR	16	2	Compression Unit (CU) Indicator The compression unit indicator (CUI) is sequential with the MSB set if it is the first packet within a CUI.	
FIRST CU only	IMAGE_LINE_SIZE	16	2	Width of an image line
	IMAGE_LENGTH	16	2	Total image length
	X_POSITION	16	2	Bottom left start position (windowed data)
	Y_POSITION	16	2	Bottom left start position (windowed data)
	COLOR_INDICATOR	16	2	Color channel of data, 0 = not applicable for Alice
FAST_DATA	8 ... 2048	1..256	Lossless (FAST) compressed alice science data; total packet data size is limited to 256+2 bytes, so for the first CU only 246 data bytes are used.	
Description of the FAST encoded data: <ul style="list-style-type: none"> • Each compressed observation consists of an integer number of Compression Units (CUs). • Each CU represents a fixed number of samples (2048). • Each CU starts with a 16 bit initial value, this value is byte aligned. • In the first CU of an observation the third byte contains the block length (16). • Each Compression Unit contains an integer number of Blocks (= 2048/block length = 128). • Each Block starts with a 5 bit number that indicates the number of bits used to encode the successive differences. • Each Block continues with the differences, the least significant bit of these small numbers is used as a sign indicator, so the differences can be positive and negative. Note that even after an initial value (start of a CU) a difference is encoded to calculate the first data sample, so the initial delta after the initial value will be zero.				

Table 7-4: PERSI-Alice CCSDS Compressed (Lossless) science packet; # = 0, 2, 4, 6.

7.2.3 *Definition of an “Observation”*

An observation will be a single histogram image or one frame of a pixel list series. Each observation will be written to a separate FITS file. A pixel list resulting from a single exposure command may therefore produce many such frames, each of which will be saved as a separate FITS file.

7.2.4 *S/C Housekeeping Needed in Level 1 Files (for Calibration)*

Spacecraft housekeeping that may be needed in the Alice pipeline include any temperature sensors on the spacecraft around the Alice instrument and the spacecraft-measured instrument bus voltage and power consumption on the different busses.

Spacecraft measured temperatures related to Alice (ApId 0x00D and 0x08D):

T_A.CDH_TEMP_ALICE_BRACK_BASE_00D

T_A.CDH_TEMP_ALICE_1_00D

T_A.CDH_TEMP_ALICE_2_00D

PDU parameters related to Alice (ApId 0x009, 0x00a, 0x089 and 0x08a):

ALICE_LVPS_A_VOLT_009

ALICE_LVPS_A_CURR_009

ALICE_LVPS_B_VOLT_009

ALICE_LVPS_B_CURR_009

ALICE_ACT_A_VOLT_00A

ALICE_ACT_A_CURR_00A

ALICE_ACT_B_VOLT_009

ALICE_ACT_B_CURR_009

Note that these temperatures currently are not used in the pipeline processing, but may be used in the future as the code and calibrations are revised.

7.3 “Calibrated” Data Specifics

“Calibrated” data as used here refers to CODMAC level 3 data.

7.3.1 *Algorithm for Pipeline*

Overview: The Alice calibration pipeline that is run at the SOC applies various calibrations to raw Alice data to convert the data from units of counts to flux units (photons/s/cm²). Four types of operations can be performed. They are, in order of application to the data: deadtime correction, dark correction, effective area correction, and flat field correction. These are described in more detail below.

7.3.1.1 **Deadtime Correction**

The Alice detector electronics require a finite time to process an event pulse. As a result, if event pulses arrive too close together in time, the latter pulse(s) will not be recorded, resulting in an effective decrease

in the sensitivity of the instrument that is a function of the count rate. The deadtime correction time constant for the high-speed electronics, i.e. the science data is 18 microseconds. The deadtime correction time constant for the low-speed electronics, i.e. the housekeeping data is 4 microseconds. At input rates below 50 kHz, the detector electronics is non-paralyzable (i.e. a fixed deadtime per event that is not re-triggerable). To calculate the detector output count rate, the following formula is used:

$$C_{\text{out}} = C_{\text{in}} / (1 + C_{\text{in}} \tau)$$

where C_{out} is the output (i.e., detected) count rate and C_{in} is the input count rate. At a count rate of 1 kHz, the deadtime correction factor (τ) is approximately 1.02, while at 20 kHz, the deadtime correction factor is approximately 1.56.

7.3.1.2 Dark Correction

The Alice detector electronics register events even when the aperture door is closed and the detector is not illuminated by FUV photons. The spatial distribution of these dark counts is approximately uniform across the detector. However, there is some low-level 2-D structure to the dark counts. Alice observations made with the aperture door closed are summed together to create a "superdark". This superdark image is then scaled to the exposure time of an Alice science observation and subtracted from the data.

During in-flight commissioning, these dark counts were measured at a rate of approximately 94 Hz across the entire detector. The primary source of dark counts is the spacecraft RTG. Dark exposures are made throughout the mission to monitor the background event rate and detector performance.

7.3.1.3 Effective Area

The sensitivity of Alice to UV photons varies as a function of wavelength. It is convenient to think of the Alice sensitivity in terms of the effective area of the instrument. For a point source located at infinity, effective area is defined as the area of the surface that intercepts incident photons at the same rate as is detected by the Alice instrument. Dividing the observed count rate by the effective area yields the incident flux of photons. In general, effective area depends on the geometric size of the instrument aperture, reflectivities of the optical surfaces, sensitivity and quantum efficiency of the detector, etc.

The Alice effective area curve is based on observations of stars that have been previously observed by IUE and HST. In wavelength regions outside those covered by the IUE/HST observations, the pre-flight effective area estimate has been linearly scaled so that it matches the effective area derived at longer wavelengths.

7.3.1.4 Flat Field

When uniformly illuminated by a monochromatic source, the counts detected by the Alice instrument vary from pixel to pixel with a standard deviation of approximately 15%. This spatial variation in instrument sensitivity is the instrument flat field response.

As of September 2007, no suitable observations have been made from which to derive an in-flight flat field calibration. Thus the flat field correction is currently disabled in the Alice pipeline code.

Update as of February, 2014: no flat field was generated during the pre-flight ground calibration, extended targets are rare to non-existent in flight for New Horizons (the spacecraft flew by the moon 9h after leaving earth orbit), and generating a flat with point sources is problematic, so no suitable flat field is available for ALICE calibration. The flat field correction in the pipeline is still effectively disabled via

the use of an all-unity flat field calibration file named `pa_flat_000.fit`, the name of which is included in the FITS header of the PDU, and which is delivered with the PDS data sets. There is what appears to be repeatable, quasi-periodic analog-to-digital noise visible in images summed along rows of darks taken during ground and flight calibrations, but its behavior across columns is not clear (cf. the ALICE Space Science Review paper, Stern et al., 2008, a pre-print copy of which is provided with the PDS data sets).

7.3.2 *Format of Calibrated Data*

7.3.2.1 Histogram

The primary data unit in the FITS file is a 2-D calibrated histogram frame consisting of 1024x32 array of 32-bit floating-point numbers. The units of the histogram image are photons/s/cm². The first data extension in the FITS file is a 1024x32 array of 32-bit floating numbers containing the uncertainty in the histogram image. The second data extension is a 1024x32 element array containing the wavelength for each pixel in the histogram image. The third data extension is the 64-element PHD, identical to that in the raw data. The fourth data extension is an array containing the number of photon events per housekeeping sampling interval. The fifth data extension is the 141 column by t row housekeeping row as in the raw data.

FITS File Storage Location	Description
Primary Data Unit (PDU)	Calibrated Histogram image (photons/sec/cm ²)
Extension #1	Uncertainties in histogram data values
Extension #2	Wavelength Image (Angstroms)
Extension #3	Pulse Height Distribution (PHD)
Extension #4	Count rate vector from HK (sampled at 1 Hz)
Extension #5	Binary Housekeeping Table

7.3.2.2 Pixel List

The primary data unit in the FITS file is a 2-D calibrated reconstructed histogram image consisting of a 1024x32 array of 32-bit floating-point numbers. The units of the histogram image are photons/s/cm². The first data extension in the FITS file is a 1024x32 array of 32-bit floating numbers containing the uncertainty in the reconstructed histogram image. The second data extension is a 1024x32 element array containing the wavelength for each pixel in the reconstructed histogram image. The third data extension contains a binary table of 5 columns and rows for each photon event. The five columns are the X (spectral) position of each photon event, the Y (spatial) position of the photon event, the wavelength of the photon event, the cumulative number of elapsed time hack intervals (starting from 0 at the beginning of the file), and the deadtime correction factor events occurring during the time hack in question. The temporal resolution of this pixel list data set is determined by the hack rate used for the pixel list acquisition. The length of this vector is variable depending on the source flux and the hack rate. The fifth data extension contains the binary housekeeping table.

FITS File Storage Location	Description
Primary Data Unit (PDU)	Reconstructed Calibrated Histogram image

	(photons/sec/cm ²)
Extension #1	Uncertainties in reconstructed histogram data values
Extension #2	Wavelength Image (Angstroms)
Extension #3	Binary Pixel List Table (X, Y, wavelength, time hack #, MET)
Extension #4	Count rate vector from pixel list data (sampled at time hack rate)
Extension #5	Binary Housekeeping Table

7.3.3 Scientific Units

For Histogram, units are photons/s/cm² (histogram), angstroms (wavelength array), and counts (PHD array).

For Pixel List, units are photons/s/cm² (generated histogram), angstroms (wavelength array), counts, pixel location, and angstroms, and seconds (pixel list array), counts per second (count rate array).

7.3.4 Additional FITS and PDS Keywords Added

Below is an example of the Mike pipeline keyword block added to the FITS header:

```

COMMENT =====
COMMENT
MIKE_BEG= 'Feb 15 16:12:57 2005' / START MIKE KEYWORD BLOCK
MIKE_VER= '2.0 [2005 Feb 15]' /Version of Mike pipeline code
K_MODE = 'ACQMODE ' / Keyword containing the mode name
K_ETIME = 'EXPTIME ' / Keyword for the effective exposure time
FILE_IN = 'test/ali_0000006498_0x4b3_eng_1.fit' / Input file for processing
FILE_OUT= 'test/test_his.fit' / Output file after processing
DIR_CAL = 'cal/ ' / Directory of calibration data
DIR_DONE= ' ' / Directory to put raw data after processing
BADFILE = ' ' / FITS file of bad pixel mask array
BADFLAG = -1 / Bad pixel mask flag
BADVALUE= -666 / Bad pixel value
DEADFILE= 'deadtime/ra_dead_002.txt' / Deadtime correction file
DEADFLAG= 1 /
DEADTYPE= 'FUN ' / Correct using FUNction or lookup table (LUT)?
DEADCORR= 'TOTAL ' / Correct by TOTAL or each PIXEL count rate?
BIASFILE= ' ' / Bias image filename
BIASFLAG= -1 / Bias correction flag
DARKFILE= 'dark/ra_dark_001.fit' / Dark image filename
DARKFLAG= -1 / Dark correction flag
FLATFILE= 'flat/ra_flat_001.fit' / Flag field image filename
FLATFLAG= -1 / Flat field correction flag
FLATNORM= 'AVERAGE ' / How to normalize flat field
WCALFLAG= 0 / Wavelength calibration flag
WCALPRO = 'alice_wavcal' / IDL program to perform wavelength calibration
WCALPARS= 'T_DELECC' / keywords for parameters to use for wave cal
    
```

New Horizons SOC to Instrument Pipeline ICD

```
AEFFFLAG=                1 /
AEFFPRO = 'alice_aeff'    / IDL program to get effective area
AEFFPARS= 'T_DELECC'      / keywords for parameters to get effective area
LOG_FILE= 'test/log.out'  / Filename to save log file (default = append to
LOG_MAIL= '                ' / address (if any) to e-mail log file
MIKE_ERR=                1 /
MIKE_END= 'Tue Feb 15 16:12:57 2005' / END MIKE KEYWORD BLOCK
COMMENT
```

=====

COMMENT

7.3.5 *Hardware/OS Development Platform*

Dell Linux, Redhat 7.2; Apple G5 Power PC and PowerBook G4, OS X v10.4

7.3.6 *Language(s) Used*

IDL

7.3.7 *Third Party Libraries Required*

IDL Astro (<http://idlastro.gsfc.nasa.gov/>)

7.3.8 *Predicted Execution time*

A few seconds per file.

7.3.9 *Contact/Support Person(s)*

, Joel Parker, and Maarten Versteeg

8. LEISA INSTRUMENT DESCRIPTION

8.1 Overview

LEISA is an infrared imaging spectrometer. The detector is a 256x256 pixel array. Spectral separation is done with a wedged optical etalon filter placed in close proximity to the detector array. The filter is made of two pieces, a high spectral resolution ($\lambda/\Delta\lambda=580$) segment and a low spectral resolution ($\lambda/\Delta\lambda=280$) segment, bonded together. The detector-filter assembly is located at the plane of focus of the Ralph telescope where a 2-D image is recorded simultaneously with the infrared spectrum of the scene. The layout for the filter assembly is shown in Figure 8-1. The wavelength range of the sensor is 1.225-2.5 μm for the low resolution segment and 2.1-2.25 μm for the high resolution segment. The wavelength of transmission of the filter varies along one axis and is constant in the other. Lines of constant wavelength are aligned with the row direction of the detector array. The number of pixel-limited spectral channels is the number of rows of the detector, excluding a number of rows (4) obscured by opaque adhesive at the bond joint between the two filter segments.

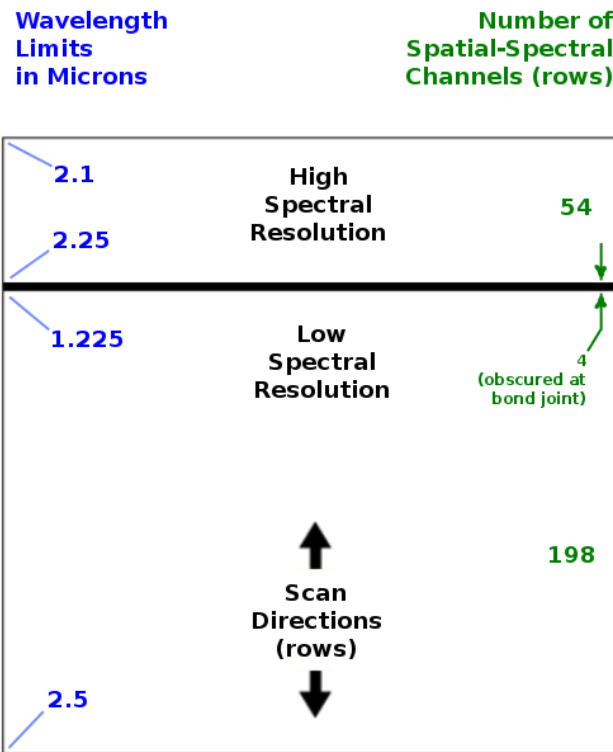

Figure 8-1: Layout for LVF Filter Assembly

The LEISA detector array is a Rockwell PICNIC device. It is read out by the Ralph electronics in Correlated Double Sample (CDS) mode. The signal is converted to a 12-bit value using the middle 12 bits of a 16 bit analog to digital (A/D) converter. There are two data transfer modes, one in which both signal and reset level data are returned (un-subtracted mode), and the other in which the reset level is subtracted from the signal level and only the difference is returned (subtracted mode).

The image cube is recorded as a series of N image frames, with N determined by the length of the scan multiplied by the frame rate. Detector frame rate is adjustable between 0.25 and 8 Hz in 1 ms steps. Each frame covers the complete range of wavelengths. LEISA is normally operated in a scanning mode, with the target moving through the image plane, row by row. Slicing the image cube along one row gives a scanned image of the target in one wavelength. Co-registering each wavelength image (removing motion and optical distortion) yields an IR spectrum of the target.

Data recorded on New Horizons is sent to the ground via the Deep Space Network. From there the data is sent to the Mission Operations Center (MOC) at the Applied Physics Laboratory (APL). The Science Operations Center (SOC) retrieves new data from the MOC daily. The SOC software pipelines convert the data from the MOC archives into FITS (Flexible Image Transport) files with scientifically useful and

calibrated data. The SOC first sorts the packets into image cubes of raw (12-bit) sensor counts with useful header keywords. These keywords include the recording mode of the observation, timing information and basic pointing information of the instrument boresight. The raw processing also gathers housekeeping (H/K) telemetry from the Ralph instrument into a table. Once the raw processing is complete, the SOC produced a calibrated data set for each observation.

8.2 Raw Data Specifics

8.2.1 Data Format

Raw Dataset

The SOC stores the LEISA data cubes in Band Interleaved by Line (BIL) order, i.e. image frames are stored sequentially. To re-order LEISA images as received from the spacecraft, the SOC does the following to each frame of data:

1. de-interlace by quadrant
2. reverse the Y direction
3. rotate 180 degrees

The resulting frames from LEISA have the (0,0,0) element of the 3-D array corresponds to the location of wavelength 2.5 μm on the LEISA filter at the minimum X axis location in the image in the first frame.

The SOC raw data product is a FITS format data file and PDS detached label file. Ancillary data for an observation is placed in the primary header of the FITS data file. The 256X256XN data cube is stored in the primary data unit as an array of integers. The first FITS extension is a binary table of Ralph housekeeping data.

Outline of the raw FITS file:

- Primary HDU - Raw 12 bit image counts
 - Primary Header (FITS + pointing + observation keywords)
 - 256 X 256 X N integer point array
- Extension 1 - Binary table of Ralph housekeeping
 - Ext. Header (keywords + binary table definition)
 - Ext. Binary Table (115 X S binary table of Ralph housekeeping data)

*[N is the number of data image frames in the observation, S is the number of seconds in the observation]

**[In the case of un-subtracted readout mode, frames alternate between read and reset signal levels]

Image Data

The primary data unit contains the raw spectral image data. Values recorded by the instrument with 12 bit precision are stored as 16 bit integers.

Housekeeping Data

Housekeeping data generated by the Ralph instrument is stored in Extension 1 as a binary table. The first field in each row of the table is mission elapsed time (MET). Table entries are sorted by increasing MET. The time interval between each table entry is fixed, one second per entry, unless there is missing data.

Pipeline Processing

The limits of an observation are established by the SOC using information in each telemetry packet of an observation sequence.

8.2.2 Data Sources (High/Low Speed, CCSDS, ITF)

Ralph housekeeping data is transmitted in the form of CCSDS (Consultative Committee for Space Data Systems) packets. One housekeeping packet is produced by the Ralph instrument each time a spacecraft PPS (pulse per second) signal is received. State information is gathered, time tagged, and written to the low speed bus in CCSDS packet form. The CCSDS packets are transmitted during the next DSN pass.

LEISA image data is transmitted in the form of CCSDS packets produced by the spacecraft compression/packetization routines from the data written to the high-speed bus. The LEISA detector has 4 output channels, one for each array quadrant. The first 4 elements of the data stream are the first pixels from each quadrant. The second 4 elements are the second pixels from each quadrant, and so on. One 'line' of data in this order is 4x 128 pixels long, and is not the same as a line in the final image. During the observation, image data is written to the spacecraft high speed bus. These data are not automatically transmitted. A compression/packetization routine is scheduled some time later that converts the Ralph sensor counts to a packetized form.

The data can be packetized without compression, with lossless compression, or with lossy JPEG compression. The packetization routine can also process a sub-frame area of interest, or a more complicated sliding subframe that tracks the image target as the scanning observation proceeds. In un-subtracted readout mode, the spacecraft interface supports only uncompressed downlink. Regardless of windowing or compression, the SOC raw data processing reassembles the data into a full 256X256XN data cube.

8.2.3 Definition of an "Observation"

Science Operation

The size of the LEISA detector is 256 x 256 pixels. One read out of all 65,536 detector pixels is called an image or frame. The data content of a LEISA "frame" is consistent with the S/C definition of the term. The processing definition of "image" is consistent with the optical definition except that the order of pixel elements is different in the electronic data stream.

An observation is a sequence of frames. The number of frames per observation is variable. Pixel values are recorded with 12 bit precision. One image contains 65536 pixels x 1.5 bytes/pixel = 98304 bytes of data, however, data is stored as 16 bit values in the SOC data files.

For normal science observations the Ralph electronics use the value of the frame rate to minimize smearing by compensating for the spacecraft motion and scan rate relative to the target. Reset levels are stored temporarily by the electronics and subtracted from read levels (subtracted mode). The difference in read and reset levels is transferred to the spacecraft. Alternately, the instrument can be forced to use a fixed frame rate value.

Un-subtracted Read-out

There is a voltage offset for each LEISA quadrant to assure the sensor signal will be in the correct range of the A/D. The offset values are set from a table when Ralph is powered on. Un-subtracted mode can be used to evaluate the offset values. In un-subtracted readout mode, reset levels are not subtracted from read levels. Both read and reset are transferred. The number of values in one data frame of the un-

subtracted mode (131,072) is 2x twice that of subtracted mode. Read and reset values are interleaved by data line and the number and order of the pixel elements in a line are the same as for subtracted mode readout. The reset of a pixel occurs after the integrated signal is read, so read levels correlate with reset levels recorded in the preceding frame. The spacecraft interface supports only uncompressed packetization of the full LEISA array for un-subtracted readout mode.

8.2.4 Housekeeping Needed in Level 1 Files (for Calibration)

Most of the H/K values are used for engineering troubleshooting and not needed for data processing. Housekeeping data that are important to further processing (see the following table) are stored in header keywords.

Keyword	Description
SIDE	Instrument hardware side
DETECTOR	Always LEISA for LEISA data
FILTER	Always WEDGE for LEISA data
LEI_OFFx	Value used to set voltage offsets for the four LEISA quadrants. x=1-4
LEI_RATE	Time between LEISA readouts (ms)

8.2.5 Science Data and/or Housekeeping Requirements

Other important information is determined by the SOC while processing the raw observation data. These values are also stored as keywords in the FITS header.

Keyword	Description
MET510	The MET of the Ralph housekeeping packet that marks the start of an observation, used to determine the observation start time and frame rate
TRUE510	Is the 0x510 real or assumed from a gap?
SCANTYPE	Always LEISA for LEISA data
LEI_MODE	RAW for un-subtracted readout mode SUBTRACTED for subtracted readout mode
STARTMET	Actual start time of first integration, in MET (s)
EXPTIME	LEISA exposure time (s). Same as RALPHEXP. There is zero dead time between frames so the frame rate is exactly 1/EXPTIME

SPICE and SPICE Kernels

The SOC maintains an archive of SPICE kernels that describe the position and attitude of the spacecraft as any time in the mission. The kernels are used to calculate many values describe the instrument

pointing during each observation, stored as header keywords with the prefix SPC. The names of the SPICE kernels used to process the observation are stored as header keywords with the prefix SPCK.

8.3 Calibrated Data Specifics

8.3.1 *Algorithm for Pipeline*

There are six processing steps applied to the raw LEISA data to produce the calibrated output:

1. Validate raw image file
2. Preprocess un-subtracted mode data
3. Process A/D rollover pixels
4. Convert raw counts to calibrated values
5. Compute pointing data
6. Construct FITS file

Validate raw image file

The input file is validated to assure the data is ready for further processing. Checks are for valid mission, instrument, mode, and image array size. The values of important keywords are validated and collected in this step.

Preprocess un-subtracted mode data

If the data readout was in un-subtracted mode, the reset values are subtracted from the read values in this step and the rest of the processing is the same, regardless of readout mode.

Process A/D rollover pixels

There are two instances where the subtracted raw data value will be off by exactly 4096 counts. The first is when the subtraction of the reset count results in a negative number. This happens because of array noise and read noise and results in small negative numbers being returned as large positive numbers. The second instance is when the subtraction of the reset count results in a number greater than 4095 (12 bits). This happens because the most significant bit of the A/D is not read. A count higher than 4095 is normally considered outside of dynamic range of LEISA, but can be corrected on a case by case bases.

If a file identifying rollover pixels for the observation exists (see next paragraph), the identified pixels are corrected for rollover. If no file exists, any subtracted count greater than 3850 is considered to have rolled over, and 4096 is subtracted from the raw count value. This is a good first-cut since the observations will not be designed to return signal counts this high.

During initial image analysis by the Ralph team, each observation is analyzed in detail. A file identifying rollover pixels is generated which identifies the pixels that are deemed to need rollover correction. The case where the read count is higher than 4095 can be detected by analyzing surrounding pixels and by watching the target scan through the array. These are also included in the rollover file. Once this file is installed on the SOC, processing of the calibrated data for the observation will automatically use the rollover file instead of the default processing.

Convert raw counts to calibrated values

There are 8 values that make up the conversion between raw signal count and calibrated signal value.

1. Electronics induced readout signal: $X1_i = RAW_i - E_i$ (Subscript i means per-pixel operation)
2. CCD flat field: $X2_i = X1_i / F_i$
3. Calibration offset: $X3_i = X2_i - O_i$
4. Calibration gain: $X4_i = X3_i / G_i$
5. Integration time: $X5_i = X4_i / I$ (I, in seconds, is constant over entire image)
6. Filter width: $X6_i = X5_i / W_i$
7. Pixel solid angle: $X7_i = X6_i / ((0.004^2 * \Pi) / ((2 * 8.6)^2))$
8. Gain correction: $CAL_i = X7_i / 0.25$ (CAL_i is the calibrated signal value)

The electronics induced readout signal is a base signal that does not depend on integration time. It has been derived from studies of the dark frames of flight data and is subtracted from the raw signal count.

The CCD flat field is derived from laboratory data and refined with in flight observation data. The flat field changes slightly as the mission progresses so a different flat field can be defined for an individual observation or a range of observations. The actual flat field used in the processing is included in the output FITS file.

The calibration offsets and calibration gains are derived from laboratory data and refined with in flight observation data. These values can change as the mission progresses. Different calibration values can be defined for an individual observation or a range of observations. The actual calibration values used in the processing are included in the output FITS file.

The integration time is divided into the calculated calibrated counts.

The filter width of each pixel is divided into the calculated calibrated counts.

The pixel solid angle is divided into the calculated calibrated counts.

The gain correction is divided into the calculated calibrated counts.

All of these values are derived from laboratory data and refined with in flight calibration observation data. They are updated, as needed and applied to the observation data automatically when re-processed

Compute pointing data

The pointing for each pixel of each frame is computed using the timing information from the observation, reconstructed ephemeris and attitude files, and knowledge of the optical distortion of the instrument. One array is generated giving the Cartesian pointing vector of each pixel in the LEISA array. This is a function only of the optical distortion of the system. A second array is generated giving the rotation quaternion of the instrument boresight into the J2000 reference frame for the middle of each exposure. By rotating the pointing vector of a pixel by the quaternion for the image frame, the J2000 pointing vector of each pixel can be derived

Construct FITS files

A FITS file is constructed to store all the calibrated image data and related processing data.

8.3.2 Dataflow Block Diagram

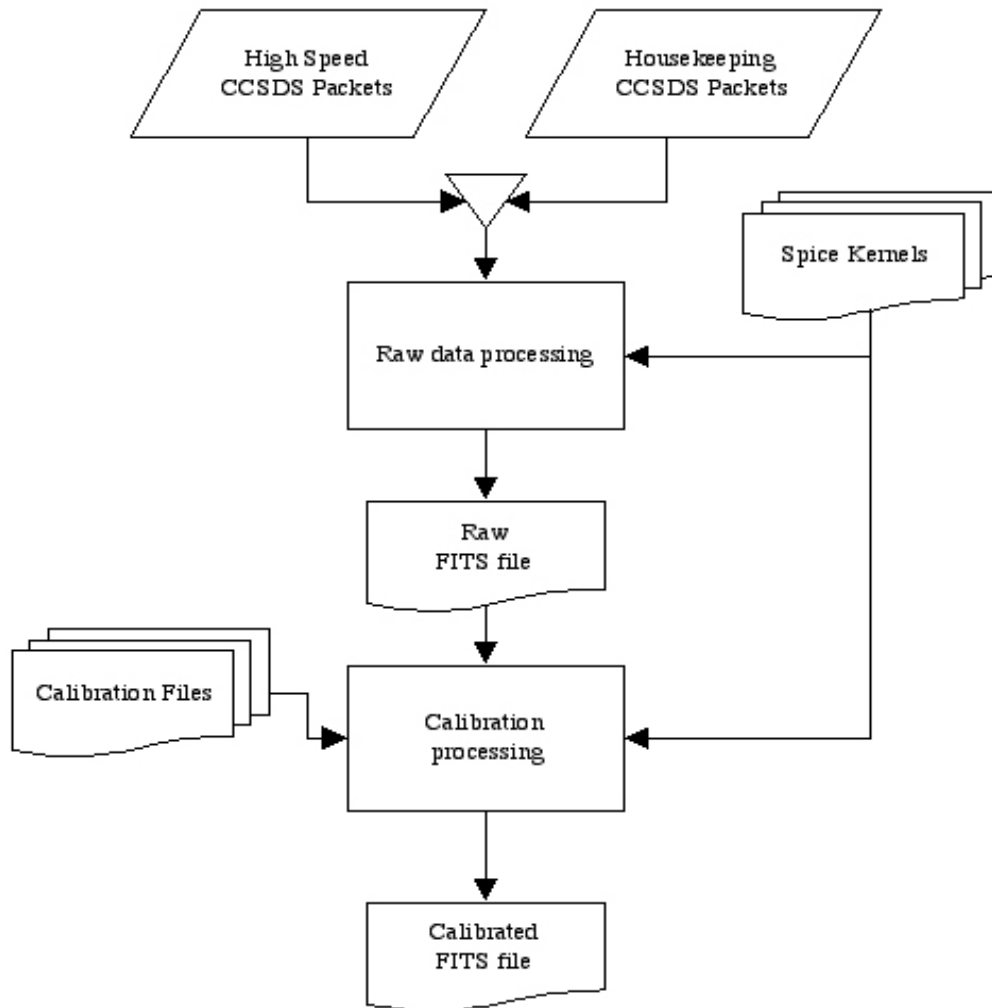

Figure 8-2:Raw and Calibrated data pipeline processing flow

8.3.3 Data Format

Calibrated Dataset

The calibrated LEISA data are stored in Band Interleaved by Line (BIL) order, exactly as the raw data is stored. The resulting frames from LEISA have the (0,0,0) element of the 3-D array corresponds to the location of wavelength 2.5 μm on the LEISA filter at the minimum X axis location in the image in the first frame.

The calibrated data product is a FITS format data file and PDS detached label file. Ancillary data for an observation is placed in the primary header of the FITS data file. The 256X256XN data cube is stored in the primary data unit as an array of floating point numbers. The FITS extensions are outlined below.

Outline of the calibrated FITS file:

- Primary HDU - Calibrated image data
 - Primary Header (FITS + pointing + observation keywords)
 - 256 X 256 X N floating point array
- Extension 1 - Center wavelength and filter width for each pixel
 - 256 X 256 X 2 floating point array
- Extension 2 - Cartesian pointing vector for each pixel
 - 256 X 256 X 3 floating point array
- Extension 3 - Flat field correction for each pixel
 - 256 X 256 X 1 floating point array
- Extension 4 - Radiometric gain and offset for each pixel
 - 256 X 256 X 2 floating point array
- Extension 5 - Error estimates for each pixel
 - 256 X 256 X 1 floating point array
 - N.B. all error estimates are zero; see *Calibration and data characteristics* below
- Extension 6 - Data quality flags for each pixel
 - 256 X 256 X 1 Integer array
- Extension 7 - Ephemeris time and quaternion for each frame
 - 5 X N floating point array
- Extension 8 - Binary table of Ralph housekeeping
 - Ext. Header (keywords + binary table definition)
 - Ext. Binary Table (115 X S binary table of Ralph housekeeping data)

*[N is the number of data image frames in the observation, S is the number of seconds in the observation]

For a description of the contents of the FITS extension, see the above section describing the SOC calibration processing.

Calibrated Image Data

The Image Data Unit of the Level 2 file contains data expressed in physical units useful for scientific interpretation. The instrument pipeline converts the data values of raw instrument counts to radiance units, $\text{erg/s/cm}^2/\text{angstrom/sr}$.

Calibration and data characteristics

i) *Error estimates are all zero.* As of late 2014, the code to calculate the values for the Error estimates extension has not been deployed to the SOC, and placeholder code sets all pixel error estimates to zero. When the updated code is deployed to the SOC, some reprocessed observations may be delivered

to PDS (e.g. Jupiter encounter data); note that observations from the Launch and Pluto Cruise mission phases have little if any science utility, so there is no incentive to reprocess those data just to provide error estimates.

ii) *Fixed-pattern noise.* There is usually fixed-pattern noise (FPN) in the data that cannot be removed by the flat-field correction. Users need to generate an average of a few run-up frames containing background sky and the FPN, and subtract that average from every frame with a target source present. The number of frames to use will vary by observation, so this operation is not part of the automated pipeline.

iii) *Scattered light.* Although some observations have been taken to characterize scattered light, no photometric modeling of the stray light has been made or applied to the data. Those observations have only been used to optimize the planned imaging at Pluto encounter to minimize the effect of stray light.

Data quality flags

The data quality flag bits are set for known problem(s) with the corresponding pixel in the image; multiple bits may be set for any one pixel. A quality flag value of zero indicates a good pixel.

Quality Flag Value (bit)	Description
1	Defect in one of the calibration files
2	Flat field out of bounds
4	Known CCD defect
32	Bad pixel not in any of above categories

8.3.4 *Extra FITS Extensions (planes) and Their Definitions*

See above

8.3.5 *Scientific Units*

Radiometric units: $\text{erg/s/cm}^2/\text{angstrom/sr}$

8.3.6 *Additional FITS and PDS Keywords Added*

See above

8.3.7 *Hardware/OS Development Platform*

The software for processing the raw and calibrated data files has been developed on the SOC computers, running GNU/Linux/i686 Version 2.6.17-1.2142_FC4.

8.3.8 *Language(s) Used*

The software for processing the raw data files is written in Python.

The software for processing the calibrated data files is written in C, with a Perl script wrapper.

8.3.9 *Third Party Libraries Required*

Python SPYCE interface library

Python MySQLdb interface library
Independent JPEG Group's JPEG software
CSPICE processing library
CFITSIO processing library

8.3.10 Calibration Files Needed (with Quantities)

The instrument software package will include additional datasets needed for calibrating the data. All the calibration software requires additional datasets needed for calibrating the data, as describe in the above sections. The instrument pipeline maintains version control on calibration datasets, as with calibration procedures. Some calibration files are associated with specific observations, some are associated with a range of observations. The calibration files are partitioned by time (MET), and the METs are the subdirectory names under the calibration top-level directory (e.g. on the SOC it the MET subdirectory will be pipeline/level2/lei/cal/METxxxxxx/; in the PDS data sets it will be CALIB/METxxxxxx/). The algorithm, for choosing which partition of calibration files files to use, is as follows:

- Find the MET subdirectory name with the highest MET value less than or equal to the MET of the data to be calibrated
 - E.g. if the data MET is 250, and the MET subdirectory paths are cal/100/, cal/200/, cal/300/, then directory path chosen is cal/200/.
 - If such a directory is found, then use the calibration files in it
- If no MET subdirectory is found, look for the cal/default/ path
 - If such a directory is found, then use the calibration files in it
- If no cal/default/ path is found, use the calibration files in cal/initial/.

The estimated number of calibration files needed for the mission is 300, totaling 3 GBs.

8.3.11 Memory Required

500MB

8.3.12 Temporary File System Space Needed

500MB

8.3.13 Predicted Size of Output File(s)

Up to 500MB

8.3.14 Predicted Execution time

Processing time for raw data files is approximately 3 seconds per image frame.

Processing time for calibrated data files is approximately .1 seconds per frame

8.3.15 Contact/Support Person(s)

Allen Lunsford
 Dennis Reuter 301-286-2042
 Donald Jennings 301-286-7701
 Laddawan Miko 301-286-2166

8.3.16 Maintenance Schedule (Code/Data Updates, Documentation)

The LPS is installed by extracting files from an archive. The sub-directory structure for the software package is created during extraction. Symbolic links to external directories may be substituted for default directory references. The shell for execution of the LPS is tcsh/csh. Changes will be made to shell initialization files; new elements are appended. Instructions for configuring the shell environment are given. A guide to installation and setup is included with the LPS package.

An initial period of testing and refinements is expected. Pieces of the software are tested separately during development. LPS modules are re-tested upon installation to the SOC. Sample datasets are provided to verify the function of software. Integrated testing of the instrument pipeline under the control of the SOC MDM is performed in accordance with the SOC. The instrument software engineer is available exclusively to the SOC to support the integration of pipeline software.

Changes to calibration datasets are made as needed. A facility is provided by the SOC so that software changes are reversible. A LEISA team member will be available to assist SOC operators in responding to unexpected errors in the instrument pipeline. Persons supporting the LEISA Instrument Pipeline software are listed above.

The LEISA instrument pipeline is developed at GSFC. The first fully functional version (v0) of the software is tested on the GSFC computer system. In advance of completion of LPS v0, a skeleton software package will be made available to the SOC. The skeleton software is a callable code set which installs and functions as the instrument pipeline but does not perform calibration and book keeping on instrument data. Completion of software Version 0 encompasses the creation of instrument calibration files. Documentation including instructions for installation and setup will be delivered to the SOC with Version 1 of the LPS. Updates of software after Version 1 are performed on an as needed basis.

Delivery Item	System	Date	Requirement
1. Skeleton Package	TSOC	04-01-2005	SOC Design Specification
2. Calibration Datasets Version 0	GSFC	05-01-2005	Ground Sensor Calibration Data
3. Instrument Pipeline Version 0	GSFC	05-15-2005	
4. Documentation	TSOC/CSOC	06-01-2005	
5. Instrument Pipeline Version 1	TSOC/CSOC	07-15-2001	SOC Systems
6. Calibration Datasets Version 1	TSOC/CSOC	08-01-2001	S/C Pre-launch Test Data
5. Instrument Pipeline (cont. updates)	TSOC/CSOC	as needed	
6. Calibration Datasets Version 2	TSOC/CSOC	03-01-2006	In-Flight Calibration Data

9. LORRI INSTRUMENT DESCRIPTION

9.1 Overview

The Long Range Reconnaissance Imager (LORRI) is a narrow angle (FOV=0.29°), high resolution (IFOV=5 μrad), Ritchey-Chrétien telescope with a 20.8 cm diameter primary mirror, a focal length of 263 cm, and a three lens field-flattening assembly. A 1024 x 1024 pixel (optically active region), back-thinned, backside-illuminated CCD detector (model CCD 47-20 from E2V) is located at the telescope focal plane and is operated in standard frame-transfer mode. LORRI does not have any color filters; it provides panchromatic imaging over a wide bandpass extending approximately from 350 nm to 850 nm. The LORRI telescope has a monolithic silicon carbide structure, built by SSG Precision Optonics, Inc., is designed to maintain focus over the entire operating temperature range (-125 C to +40 C) without a focus adjustment mechanism. A detailed description of the design and fabrication of LORRI can be found in the paper by Conard, et al., "[Design and fabrication of the New Horizons Long-Range Reconnaissance Imager](#)" in [SPIE proceedings 5906-49, 2005](#). A detailed discussion of the performance of LORRI, as measured during calibration testing before launch, can be found in the paper by Morgan et al., "Calibration of the New Horizons Long-Range Reconnaissance Image" in [SPIE proceedings 5606-49, 2005](#).

LORRI is a supplemental instrument on New Horizons and is not needed to meet the baseline scientific objectives of the mission. Nevertheless, LORRI adds significant capabilities to New Horizons, including the highest available spatial resolution (50 m/pixel at the Pluto closest approach distance of 10,000 km) and redundancy for the primary optical imager, MVIC on Ralph.

The exposure time for LORRI is adjustable in 1 msec increments from 0 ms to 29,967 msec. However, exposure times will normally be limited to ≤ 150 msec to prevent image smear associated with spacecraft motion during observations. Initially, the shortest useful exposure time was expected to be ~40 msec owing to frame transfer smear associated with the transfer of charge from the active CCD region to the storage region, during which time the active region remains exposed to the image scene because LORRI has no shutter, but an improved frame transfer smear removal algorithm was developed that now permits exposure times as little as 1 msec. The LORRI exposure time can be commanded to a specific value, or LORRI can be operated in "auto-exposure" mode, in which the LORRI flight software sets the exposure time automatically based on the signal level in a previous image. In auto-exposure mode, the algorithm used to set the exposure time depends on several adjustable parameters that are stored in an onboard table. The optimal values for these table parameters vary with the type of scene being observed, which means that new table loads may be required prior to some observations. Although the LORRI auto-exposure mode worked well during ground testing, no decision has yet been made on whether it will be used in-flight during encounter observations.

LORRI can also be operated in "rebin" mode, in which case the signal in a 4 x 4 pixel region is summed on-chip to produce an active region that is effectively 256 x 256 pixels covering the entire 0.29° FOV. The main purpose of this mode is to provide high sensitivity acquisition of a Kuiper Belt object (KBO), which requires an exposure time of ~10 sec. Although LORRI rebin mode may never be used for science observations, the LORRI pipeline is still required to calibrate rebinned images.

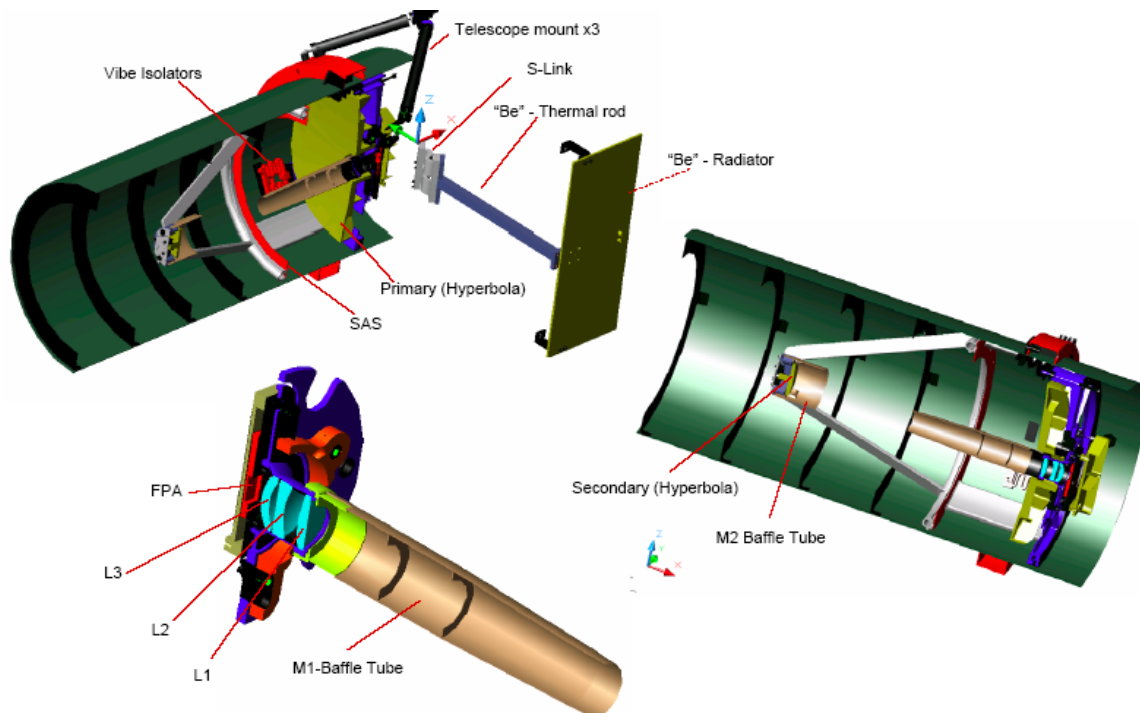

Figure 9-1: Cutaway Views of LORRI

9.2 Raw image Specifics

9.2.1 Data Format

The raw image data is organized in a FITS file. The primary header and data unit (HDU) is used to store the reconstructed image from telemetry. Additional data are stored in the extensions of the file. The two tables below contain a description of the layout for the extensions for raw data.

As described previously, LORRI operates in two binning modes: 1x1 and 4x4. For the 1x1 binning mode, the raw image dimensions are 1028x1024 where columns 0 through 1023 are the optically active region of the CCD and the remaining columns (1024-1027) are from optically inactive region (dark columns) of the CCD and represent a temperature-specific measurement of the bias value. For the 4x4 binning mode, the raw image dimensions are 257 x 256 where columns 0 through 255 are optically active and column 256 for the dark column.

FITS File Storage Location	Description
Primary HDU	Reconstructed image from telemetry
First Extension	histogram from image descriptor packet (ApID 0x611)
Second Extension	Instrument housekeeping from first 34 pixels
Third Extension	Matching image descriptor

Table 9-1 Raw FITS file extension layout (ApID => Packet Application ID)

9.2.2 Data Sources (*High/Low Speed, CCSDS, ITF*)

The LORRI high-rate data is delivered to the Instrument Interface card over a low-voltage differential signal (LVDS) interface and is then transferred to the SSR through the spacecraft high-speed PCI bus by the C&DH software. The image data is stored directly on the SSR and CCSDS (Consultative Committee for Space Data Systems) packets are generated by command to the C&DH software as is described in the table below. The ApID (packet Application Process IDentifier; also Application ID) from which the image originated is part of the filename, so this mapping may provide some assistance in decoding the filenames retrieved from the SOC.

ApID	MNEMONIC	Description
0x0601	LORRI_MEM_DMP	Memory Dump
0x0602	LORRI_MEM_CKSM	Memory Checksum
0x0603	LORRI_CMD_ECHO	Command Echo
0x0604	LORRI_ALARM	Alarm
0x0605	LORRI_STAT	Status
0x0606	LORRI_MON	Monitor Limits
0x0607	LORRI_BOOT	Boot Status
0x0608	LORRI_MAC_DMP	Macro Dump
0x0609	LORRI_MAC_CKSM	Macro Checksum
0x0610	LORRI_PARM	Parameters
0x0611	LORRI_IMG_DES	Image Descriptor

Table 9-2 Low Rate Instrument Telemetry Description

ApID	C&DH side	binning mode	compression type
0x630	1	1x1	lossless
0x631	1	1x1	packetized
0x632	1	1x1	lossy
0x633	1	4x4	lossless
0x634	1	4x4	packetized
0x635	1	4x4	lossy
0x636	2	1x1	lossless
0x637	2	1x1	packetized
0x638	2	1x1	lossy
0x639	2	4x4	lossless
0x63A	2	4x4	packetized
0x63B	2	4x4	lossy

Table 9-3 LORRI high-speed telemetry description

9.2.3 Definition of an “Observation”

Each LORRI image is an “observation.”

9.2.4 Housekeeping Needed in Raw Image Files (for Calibration)

No special requirements other than pointing

9.2.5 Raw Science Data and/or Housekeeping Requirements

No special requirements

9.3 Calibrated Image Specifics

9.3.1 Algorithms for Pipeline Calibration Process

The calibration of LORRI images potentially involves all of the following steps:

- 1) Bias subtraction
- 2) Signal linearization
- 3) Charge transfer inefficiency (CTI) correction
- 4) Dark subtraction
- 5) Smear removal
- 6) Flat-fielding
- 7) Absolute calibration

Ground testing has demonstrated that the linearization, CTI, and dark subtraction steps will not be needed, so they are not described below. Nevertheless, the LORRI pipeline architecture will be maintained to allow these additional steps to be incorporated quickly, if in-flight data suggest they are needed.

The LORRI pipeline software consists of a series of IDL routines that implement the above processing steps. In general, the IDL routines have the following naming convention: *lorri_function.pro*, where “function” refers to the specific task performed by that routine. (The “pro” extension will be omitted below when discussing specific routines.) Each routine typically has several command line arguments and keywords that specify the input and output files and, possibly, parameters for tailoring the routine for particular circumstances. The routines that perform the bias subtraction, the smear removal, and the flat-fielding are described below. No special routines are provided to perform the absolute calibration. Instead, the absolute calibration is performed using keywords provided in the FITS header, as described further in Section 9.3.1.4.

9.3.1.1 Bias Subtraction

If an image has an associated “dark” image (i.e., an image taken with the same exposure time but without any illumination), then the debiased image is simply the difference of those two images. This was usually the case during on-ground testing when images taken of a scene were immediately followed by images taken with the scene blocked (i.e., an obstruction was placed in the optical path to block the illumination). However, in-flight images may often be taken without accompanying darks either because of limitations on downlink bandwidth, or because a decision is made to take more target images at the expense of concurrent darks. In either case, the same pipeline routine will be used to debias the image (*lorri_debias*), but the algorithm employed is different in each case and different reference files are required.

If in-flight data indicate that bias images are stable over time, many bias images will be combined (after filtering out clearly discrepant pixels) to produce a “super-bias” image. Then the median value of the inactive region of the image (i.e., the median of a 1024 row by 4 column region) is subtracted from the super-bias image to produce a “delta-bias” image. The IDL procedure that produces the delta-bias image is called *lorri_delta_bias*, but this routine is *not* part of the standard LORRI calibration pipeline; rather, it is an ancillary routine used to produce a calibration reference file.

The delta-bias image will exhibit the pixel-to-pixel variation in the bias and will oscillate about zero. The bias subtraction for any new image is then a two-step process:

- 1) The median signal level in the inactive region of the image is subtracted from each pixel's value to remove the overall bias level, and
- 2) The delta-bias image is subtracted from the image created in the previous step to remove the pixel-to-pixel variation and produce the final, debiased image.

Ground calibration testing showed that the overall bias level in step (1) above depends on the signal level in the last few columns of the active region of the CCD. The effect is produced by amplifier undershoot, which means that the bias level recorded by the pixels in the inactive region is smaller than the actual bias level. The magnitude of the effect depends on the signal level in the active region and on the column number in the inactive region and can be as large as ~12 DN. Thus, prior to computing the median signal in the inactive region (step 1 above), the intensities of all the pixels must be corrected for amplifier undershoot. This correction step is incorporated into the *lorri_debias* procedure.

If the in-flight bias images vary significantly in time, separate bias images (i.e., 0 ms exposures) must be taken for each science image obtained. In this case, the bias subtraction proceeds exactly as performed during ground calibration testing, with the bias removal achieved by simple subtraction of the bias image from the science image. There are several drawbacks to this approach: (1) more images must be taken, which affects the data volume that must be stored on the on-board solid-state recorder, (2) more data must be downlinked, which may not be possible because of limited downlink bandwidth and/or the cost associated with the extra Deep Space Network (DSN) support required, (3) the signal-to-noise ratio (SNR) may be degraded because the bias subtraction no longer involves a high SNR reference file, and (4) fewer science images can be obtained because they have been displaced in the observing timeline by extra bias images.

9.3.1.2 Smear Removal

LORRI does not have a shutter, so the target being observed illuminates the active region of the CCD whenever LORRI is pointed at the scene. In particular, the CCD continues to record the scene as the charge is transferred from the active portion to the storage area, and this results in a smearing of the observed scene. Fortunately, this smear can be removed to high accuracy using the correction algorithm described below.

When bright objects are observed, the readout smear makes the raw image difficult to use for analysis purposes. In the image of Jupiter below, the raw image is on the left and the calibrated image with readout smear (aka frame transfer smear) removed is on the right.

T_{exp} = 2 ms, Jupiter diameter = 517 pixels, 2007 January 24

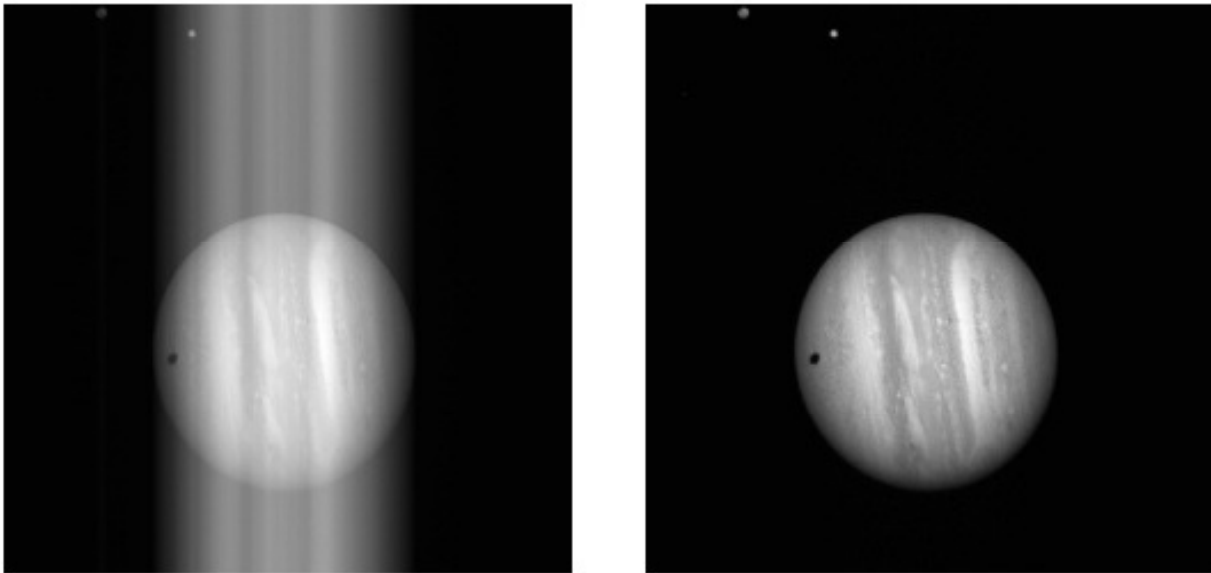

Figure 9-2: Demonstration of Smear Removal

The need for the readout smear removal arises from the operation of the frame transfer CCD used in LORRI, where first the image zone is flushed, then an exposure is taken, and finally the image is transferred into the storage zone. Hence a pixel of the raw image is exposed to the scene radiance from the corresponding geometrical element of the scene, but it is also exposed to the radiances of all the scene elements in the same image column during the image transfers. Thus the raw image is the superposition of the scene radiance and the signal acquired during frame transfers, which is called readout smear.

The readout smear is removed as follows. Let $P_{i,j}^{meas}$ = measured image array in DN where i, j are the column and row indices, respectively. Let the exposure time be written T_{exp} , with the transfer times for the frame scrub T_{f1} and the frame storage T_{f2} and with N the number of rows (which is 1024 for 1x1

images and 256 for 4x4). Let T_{favg} be the average of T_{f1} and T_{f2} to define the constant $A = \frac{T_{exp}}{T_{exp} - \frac{T_{favg}}{N}}$.

Finally we define the $N \times N$ constant matrix $\epsilon_{k,j} = \begin{cases} T_{f1} / T_{favg} & \text{for } k < j \\ 1 & \text{for } k = j \\ T_{f2} / T_{favg} & \text{for } k > j \end{cases}$

with $k, j = 1, \dots, N$, and we calculate the $N \times N$ matrix $\lambda_{i,j}^{(1)} * T_{exp} = A \left[P_{i,j}^{meas} - \frac{A T_{favg} \sum_k P_{i,k}^{meas} \epsilon_{k,j}}{N(T_{exp} + A T_{favg})} \right]$.

The desmeared image is then

$$P_{i,j}^{desmear} = A \left[P_{i,j}^{meas} - \frac{A T_{favg} \left[\sum_k P_{i,k}^{meas} \epsilon_{k,j} + \frac{E_{i,j}}{A} \right]}{N(T_{exp} + A T_{favg})} \right]$$

with $\frac{E_{i,j}}{A} = T_{favg} \left[\sum_k \lambda_{i,k}^{(1)} \epsilon_{k,j} - \frac{1}{N} \sum_l \sum_k \lambda_{i,k}^{(1)} \epsilon_{k,j} \epsilon_{l,j} \right]$. In-flight tests have verified desmear by this technique using observations of Jupiter obtained at exposure times as short as 1 ms.

The value for T_{favg} is dependent on the desired exposure time and has been determined empirically using in-flight data. The following Table 9-4 provides the appropriate values at different exposure times.

Desired Exposure Time (msec)	Value for T_{favg} (msec)
1	7.1
2	8.75
3	9.65
6	10.5
Nominal	10.7

Table 9-4 Value for Tavg from Texp

It should be noted that when the raw data is saturated, the resulting readout smear correction will be inaccurate. The algorithm relies on an accurate accumulation of charge in all rows of each column and if the raw data is clipped for lack of dynamic range to capture that integrated signal, the effect of readout smear cannot be completely and properly removed.

This correction algorithm has been implemented in the IDL routine *lorri_desmear*.

9.3.1.3 Flat-Fielding

Flat-fielding refers to the process of removing the pixel-to-pixel sensitivity variations in the image. An exposure obtained by illuminating the LORRI aperture uniformly with light is called a “flat-field” image. During ground calibration testing, flat-fields were obtained by using an “integrating sphere to provide uniform illumination. The light source was a xenon arc lamp with a spectrum similar to that of the sun. The absolute intensity of the input illumination was measured using a calibrated photodiode. For the panchromatic case, which is the one most relevant for flat-fielding LORRI images, the light from the xenon lamp was unfiltered. Flat-field images were also obtained by passing the light through bandpass filters centered at five different wavelengths spanning the range over which LORRI is sensitive, prior to injection into the reference sphere, in order to estimate the sensitivity of the flat-fields to the spectral distribution of the source. The spatial patterns in the flat-field images change fairly dramatically with

wavelength. However, the variation in panchromatic flat-fields caused by differences in the spectral distribution of the illumination source should be much less significant. Indeed, panchromatic flat-field images produced using a tungsten lamp were virtually indistinguishable from those produced by the xenon lamp. Flat-fields were obtained at four different telescope temperatures (at standard laboratory room temperature, and at the lowest, nominal, and highest temperatures predicted for in-flight conditions), but no significant temperature variations in the flat-field images were detected.

The flat-field reference file used in the LORRI pipeline was produced by averaging 100 flat-field images taken at room temperature using the xenon arc lamp as the light source, debiasing and desmearing the average image as described earlier, and normalizing the intensities in the active region to a median value of 1. If “S” (units are DN) is an image of a target that has already been desmeared and debiased, and if “FF” is the reference flat-field image, then the flat-fielded (i.e., photometrically-corrected) target image (“C”; units are DN) is given by:

$$C = S/FF$$

The flat-fielding correction is implemented in the LORRI pipeline by the routine *lorri_flatten*.

If in-flight measurements indicate that the LORRI flat-field characteristics are different than those measured during ground calibration tests, new reference flat-field images must be obtained. Although LORRI has two internal reference lamps (sometimes referred to as “cal lamps”), the illumination pattern is highly non-uniform and, thus, not very suitable as a secondary flat-field standard. Various test measurements will be performed during the early portion of the mission to determine if scattered sunlight can serve as a suitable secondary flat-field standard. If there is a Jupiter encounter, smeared images of Jupiter might also prove to be useful as a secondary flat-field standard. In any case, there will be an attempt to monitor the flat-field characteristics of LORRI over time, and the reference flat-field image used by the LORRI pipeline will be updated as necessary to maintain an accuracy better than 1% in the correction of the pixel-to-pixel sensitivity variation, except possibly near the center of the field where image ghosts may compromise the quality of the reference flat-field (see further discussion below).

During ground calibration tests, intensity artifacts caused by optical ghosts were observed near the center (roughly covering a 200 x 200 pixel region) of the flat-field images. Ray tracing of the optical system indicates that the intensity of the ghost image should be less than ~1% of the intensity produced by the direct illumination, but measurements indicated that ghost intensities have an amplitude of ~5-7% of the direct intensity for panchromatic illumination. The ghost intensity is scene-dependent with most (~80%) of the ghost signal arising from regions outside the nominal field-of-view of LORRI. There is a suspicion that at least some of the ghost signal is an artifact of the test conditions, and the reference flat-fields currently used by the pipeline do *not* include the ghost signal produced by the out-of-field light. Any flat-field data taken in-flight will be carefully scrutinized to search for any effects attributable to optical ghosts. Depending on those results, further modifications to the reference flat-fields may be required. There is also the possibility that different flat-field reference images may be required depending on the scene being imaged (i.e., a ghost subtraction step may be required prior to application of the flat-field correction under some circumstances).

9.3.1.4 Absolute Calibration (Conversion from corrected DN to physical units)

The calibration software pipeline does not perform the conversion from DN to physical units because that conversion requires knowledge of the spectral distribution (i.e. color) of the target. Instead, various LORRI FITS header keywords (“photometry” keywords) are provided that allow users to convert from

DN to physical units depending on the spectral type and spatial distribution (diffuse vs. point source) of the target.

Photometry keywords are provided for targets having spectral distributions similar to Pluto, Charon, Pholus, Jupiter, and the Sun. The units adopted for the radiance (aka "intensity") of diffuse targets are $\text{ergs/cm}^2/\text{s}/\text{sr}/\text{\AA}$. The units adopted for the irradiance (aka "flux") of point (i.e., unresolved) targets are $\text{ergs/cm}^2/\text{s}/\text{\AA}$. Tables providing the values for the photometry keywords at the time of launch are given below. The latest (i.e., current) values of the photometry keywords are provided in the header of the calibrated image FITS file for the image being analyzed.

The absolute calibration is achieved by specifying a keyword (RPLUTO) in the header of the calibrated image file that allows the user to convert a count rate ("C/TEXP" in DN/s/pixel, where "C" is the flat-fielded signal in a pixel and "TEXP" is the exposure time) for a resolved source into a radiance value ("I" in $\text{ergs/cm}^2/\text{s}/\text{sr}/\text{\AA}$) at LORRI's pivot wavelength (specified by the FITS keyword PIVOT; see below), assuming that the spectrum of the target is identical to the globally-averaged spectrum of Pluto. The relevant formula is:

$$I = C/\text{TEXP}/\text{RPLUTO}$$

Similarly, the keyword RSOLAR allows the conversion of the count rate for a resolved source into a radiance value at the pivot wavelength assuming that the target has a solar-like spectral distribution:

$$I = C/\text{TEXP}/\text{RSOLAR}$$

Finally, the keyword RPHOLUS allows the conversion of the count rate for a resolved source into a radiance value at the pivot wavelength assuming that the target has a spectral distribution identical to that of the centaur object 5145 Pholus, which may be a good analog for the reddest regions on Pluto:

$$I = C/\text{TEXP}/\text{RPHOLUS}$$

The current best estimates for these sensitivity keywords, based on ground calibration tests, are provided in the table below. In-flight calibration observations of photometric standard stars will be used to verify these values and to monitor them over time.

Keyword	Value [(DN/s/pixel)/(ergs/cm²/s/sr/Å)]
RSOLAR	2.664 x 10 ⁵
RPLUTO	2.575 x 10 ⁵
RCHARON	2.630 x 10 ⁵
RJUPITER	2.347 x 10 ⁵
RPHOLUS	3.243 x 10 ³

If users need conversions for other spectral distributions, they must derive those themselves using the LORRI spectral response function provided in the paper describing LORRI's in-flight calibration results.

The pivot wavelength (PIVOT) is given by:

$$PIVOT = \sqrt{\frac{\int P\lambda d\lambda}{\int Pd\lambda/\lambda}}$$

where “P” is the LORRI system quantum efficiency (i.e., fraction of photons detected) at wavelength “ λ ”. The current best estimate for the LORRI pivot wavelength is 6076 Å.

For unresolved sources (e.g., stars), the absolutely calibrated flux (also called “irradiance”) at the pivot wavelength can be determined using keywords that are defined analogously to the photometry keywords discussed above for resolved sources. In the case of a source having a spectral distribution identical to that of a globally-averaged Pluto spectrum, the observed count rate integrated over the LORRI PSF (“CINT/TEXP” in DN/s, where CINT is the total number of flat-field corrected counts integrated over the image and “TEXP” is the exposure time) can be related to the flux (“F” in ergs/cm²/s/Å) by:

$$F = CINT/TEXP/PPLUTO$$

Similarly, the flux at the pivot wavelength for a target having the same spectral distribution as the sun is given by:

$$F = CINT/TEXP/PSOLAR$$

And the flux at the pivot wavelength for a target having the same spectral distribution as 5145 Pholus is given by:

$$F = CINT/TEXP/PPHOLUS$$

The current best estimates for these sensitivity keywords, based on ground calibration tests, are provided in the table below. In-flight calibration observations of photometric standard stars will be used to verify these values and to monitor them over time.

Keyword	Value [(DN/s)/(ergs/cm²/s/Å)]
PSOLAR	1.066 x 10 ¹⁶
PPLUTO	1.030 x 10 ¹⁶
PCHARON	1.052 x 10 ¹⁶
PJUPITER	9.386 x 10 ¹⁶
PPHOLUS	1.297 x 10 ¹⁶

Synthetic photometry techniques can be used to convert the fluxes derived in the manner described above to fluxes at other wavelengths, and then into standard *UBVRI* magnitudes in the Landolt (1992) photometric system, which is essentially identical to the Johnson *UBV* system combined with the Kron-

Cousins *RI* system. The results described in the LORRI calibration paper can be used to derive fluxes for targets whose spectral distributions do not match the three cases discussed above.

We provide below some examples showing how to convert from engineering units to physical units, for both diffuse and point targets.

Consider a diffuse target whose spectrum is similar to that of Pluto. You should then use the RPLUTO photometry keyword in the header of the calibrated image file to convert a count rate (“C/TEXP” in DN/s/pixel, where “C” is the flat-fielded signal in a pixel and “TEXP” is the exposure time) into a radiance value (“I” in ergs/cm²/s/sr/Å) at LORRI’s “pivot” wavelength (specified by the FITS keyword PIVOT for the formal definition of the pivot wavelength):

$$I = C/TEXP/RPLUTO$$

Similarly, the photometry keywords RSOLAR, RCHARON, RJUPITER, and RPHOLUS should be used to convert count rates into radiance values at the pivot wavelength assuming that the target has, respectively, solar-like, Charon-like, Jupiter-like, or Pholus-like spectral distributions.

For LORRI, the pivot wavelength is 6076.2 Å, and we don't expect this to change, at least not significantly. Since the solar flux (F_{solar}) at a heliocentric distance of 1 AU at the pivot wavelength is 176 erg/cm²/s/Å, the value for the radiance can be converted to I/F (where $\pi * F = F_{\text{solar}}$) using:

$$I/F = \pi * I * r^2 / F_{\text{solar}}$$

where “r” is the target's heliocentric distance in AU.

For unresolved targets (e.g., stars), the absolutely calibrated flux (also called the “irradiance”) at the pivot wavelength can be determined using keywords that are defined analogously to the photometry keywords discussed above for resolved targets. In the case of a target having a spectral distribution identical to that of a globally-averaged Pluto spectrum, the observed count rate integrated over the LORRI PSF (“CINT/TEXP” in DN/s, where CINT is the total number of flat-field corrected counts integrated over the image and “TEXP” is the exposure time) can be related to the flux (“F” in ergs/cm²/s/Å; not to be confused with “F” in I/F) by:

$$F = CINT/TEXP/PPLUTO$$

When observing point targets, it is more common to convert the absolute flux to a magnitude in a standard photometric system. The following equation can be used to transform a measured value of the irradiance (aka “flux”) of an unresolved target to a magnitude in the standard V band:

$$V = -2.5 \log S + \text{PHOTZPT} + \text{CC} + \text{BC}$$

where “V” is the visual magnitude in the Johnson photometric system, PHOTZPT is the “stellar photometry keyword”, which is the “zero point” of the LORRI instrumental magnitude system, “S” is the integrated net signal rate from the target in DN/s, “CC” is the color correction (i.e., correction for the spectral distribution of the target), and “BC” is the aperture correction (in case the flux is not integrated over the entire stellar image; a careful analysis of the flux versus aperture size for a bright star in the field can then be used to determine the value of BC for the aperture selected for the photometry).

In-flight photometry of stars in the open galactic cluster M7 yield the following:

$$\text{PHOTZPT} = 18.94$$

Spectral Type	CC
O, B, A stars	-0.06
F, G stars	0
K stars	+0.4
M stars	+0.6
Pluto	-0.037
Charon	-0.014
Jupiter	-0.138
Pholus	+0.213

Table 9-5 Color correction coefficient for various targets

The following reference flux information is provided for convenience and was gathered from several sources. The UBV are in the Johnson system, RI are in the Landolt-Kron-Cousins system, and JHK_sK are in the UKIRT system.

The fluxes for Vega are from the model STScI absolutely-calibrated spectrum. At near-IR wavelengths, the model underestimates the actual Vega flux by about 5-6% owing to the excess flux from the Vega dust disk. Note also that Vega has U=B=V=0.03 (i.e., not 0).

Band	Center (Å)	Vega Flux (ergs/cm ² /s/Å)
U	3600	3.05 x 10 ⁻⁹
B	4400	6.74 x 10 ⁻⁹
V	5500	3.54 x 10 ⁻⁹
R	6500	2.11 x 10 ⁻⁹
I	8000	1.12 x 10 ⁻⁹
J	12200	3.18 x 10 ⁻¹⁰
H	16540	1.11 x 10 ⁻¹⁰
K _s	21570	4.10 x 10 ⁻¹¹
K	21790	3.97 x 10 ⁻¹¹

Table 9-6 Fluxes for Vega

9.3.1.5 Pointing Information

Pointing information for the LORRI boresight (center of the LORRI field-of-view, which is pixel [511,511]) is included in the FITS header in both the raw and the calibrated image files. An example of this information follows:

SPCBLRA = 233.4199004768138 / [degrees] Boresight RA, EME J2000

SPCBLDEC= -17.96897170490819 / [degrees] Boresight DEC, EME J2000

SPCEMEN = 283.935414259362 / [degrees] EME J2k North Clk Angle, CW from UP

9.3.1.6 Conversion of instrument housekeeping items to engineering units

The LORRI-specific housekeeping items reported in the raw FITS file are in units of counts or DN. To make these values more useful for data analysis, they have been converted to engineering units (volts, amps, degrees Celsius) and reported at the tail end of the header of the primary HDU of the calibrated FITS file. Because the contents of the raw header are duplicated in the calibrated file, a different set of tag names are used for the values that have been converted to engineering units. The new tags are reported after the comment that reads “LORRI Level 2 Calibrated telemetry items”.

9.3.2 Instrument Characterization

There are several characteristics of the instrument that are related to the radiometric calibration of LORRI that will be useful when analyzing the calibrated image data. They are the quantum efficiency and spectral responsivity, each as a function of wavelength. There are tables for each of these in the calibration directory for the PDS archive, but a graph for each is reproduced in the figures below.

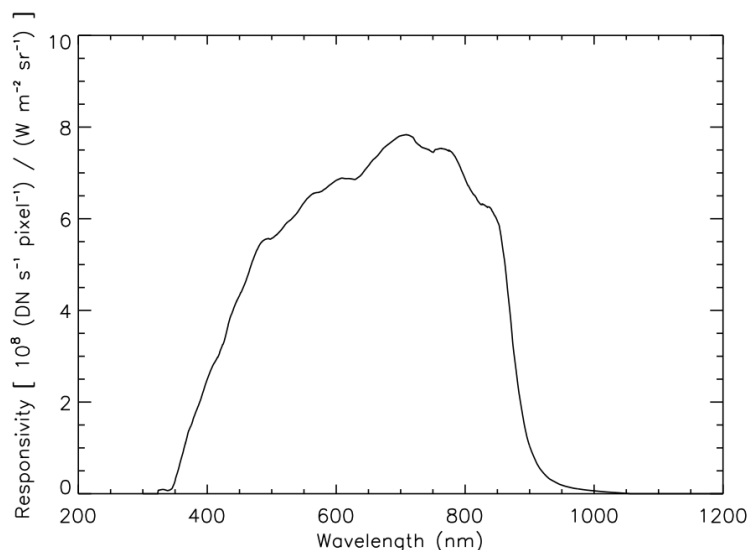

Figure 9-3 LORRI Spectral Response vs Wavelength

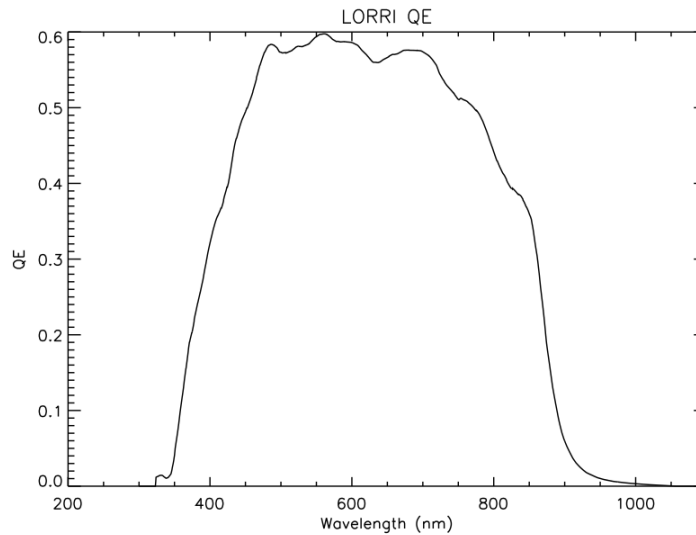

Figure 9-4 LORRI Quantum Efficiency vs Wavelength

9.3.3 *Special Processing*

After the data have been calibrated, additional processing steps are likely to be required. Obvious examples of this are ghost removal and stray light processing. At present, there have been no algorithms developed for public release because they are highly scene dependent. Individual images must be analyzed to understand the structure of the effects to determine an appropriate method for its removal. In the example below, a cutout from a calibrated image is presented to illustrate the effect of stray light from Jupiter's disk, which is just out of the field of view. The circular structure is an example of the ghost pattern. The image on the right demonstrates the processed version of that image. The gradient from the stray light has been removed, as well as the majority of the effects of the ghost.

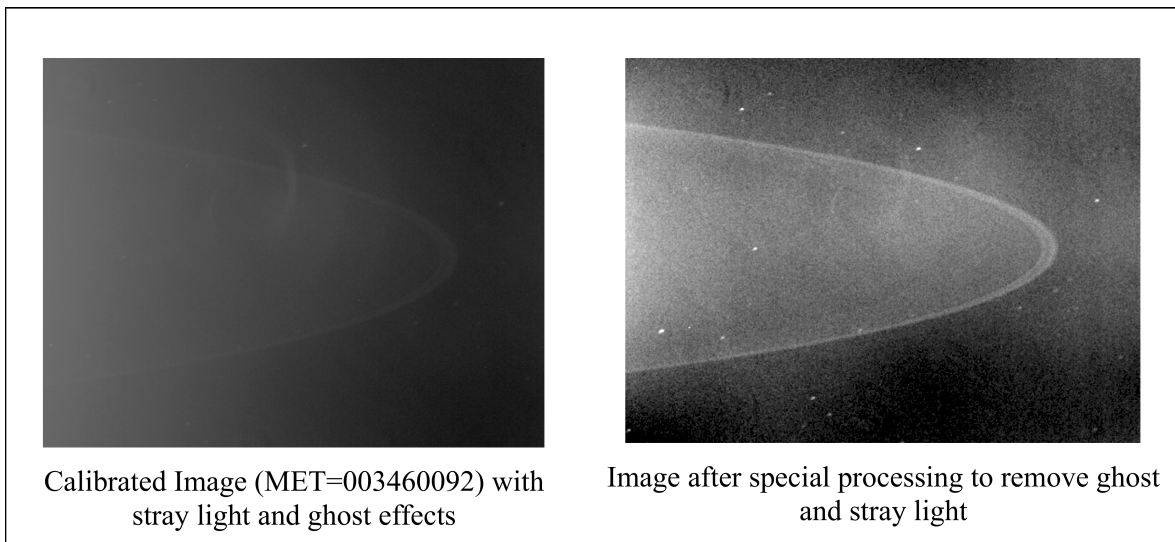
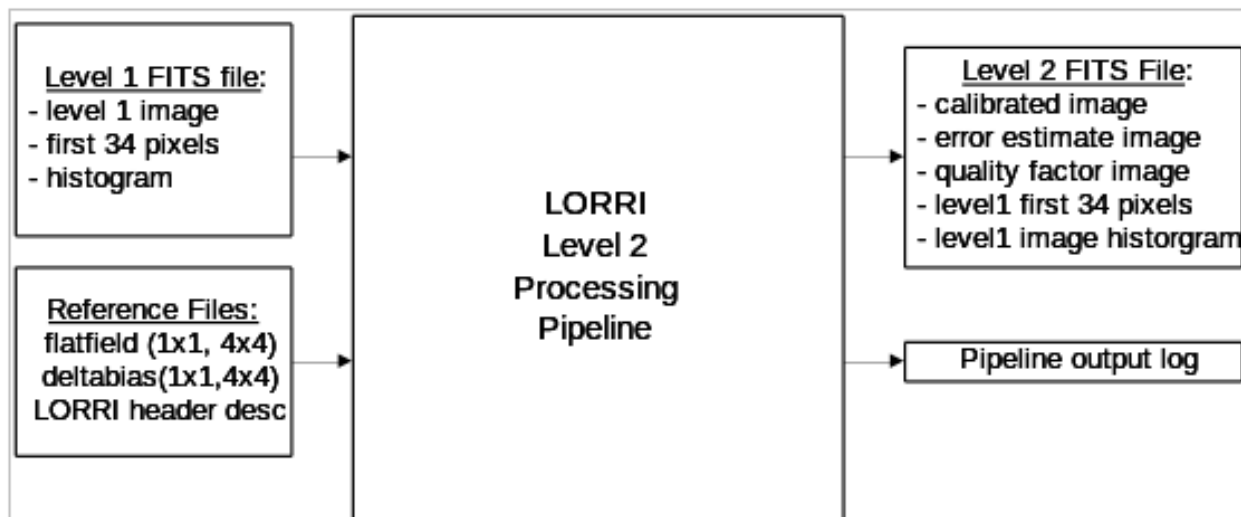

Figure 9-5 Example of Special Processing of Calibrated Data

9.3.4 Dataflow Block Diagram



9.3.5 Data Format

The calibrated image data is organized in a FITS file. The primary header and data unit (HDU) is used to store the calibrated image that results from the calibration pipeline. The first extension is the error estimate image, followed by the second extension containing the data quality image. The table below contains a description of the layout for the extensions for calibrated data.

For 1x1 binning mode, the calibrated image dimensions are 1024x1024, and for 4x4 mode, the dimensions are 256x256 pixels. In both situations, these pixels correspond to the optically active pixels from the raw image mentioned previously.

FITS File Storage Location	Description
Primary HDU	Calibrated image
First Extension	Error image
Second Extension	Data Quality Image

Table 9-7 Calibrated FITS file extension layout

9.3.6 *Extra FITS Extensions (planes) and Their Definitions*

LORRI calibrated FITS files have 3 extensions. The debiased, desmeared LORRI image is written into the primary HDU as a 2-dimensional, 32-bit real image. The unit for each data value is photometrically-corrected DN. The estimated errors in these corrected DN values are stored as a 2-dimensional, 16-bit real image in the first extension. A data quality image is stored in the second extension as a 2-dimensional, 16-bit integer image.

The error in the photometrically-corrected signal is estimated from:

$$\sigma = \frac{\sqrt{(P_{meas}/g) + (RN)^2 + (fP_{meas})^2}}{FF}$$

where “ σ ” is the 1-sigma error in the corrected signal for a particular pixel (DN), “ P_{meas} ” is the observed signal in that pixel (DN, after bias subtraction but before smear removal), “ g ” is the electronics gain (22 e/DN), “ RN ” is the electronics noise (1.3 DN), “ f ” is the estimated error in the reference flat-field image (0.005), and “ FF ” is the value of the reference flat-field image at the relevant pixel. The above formula neglects any noise contributed by the bias and smear removal steps, but those errors are generally expected to be small compared to the other sources of error.

The data quality image is used to flag pixels that have known artifacts and may need special consideration when performing scientific analysis. The pixel value in the quality flag image represents the sum of all quality flags present for that pixel. This pixel value can also be described as the result of the bitwise ‘OR’ of each quality flag value. The list of data quality values and their descriptions are listed in the table below:

Quality Flag Value	Bit position in 2-byte word	Description
0	n/a	Good pixel
1	0	Defect in reference deltabias image (set if 0 or NaN)
2	1	Defect in reference flatfield image (set if 0 or NaN)
4	2	Permanent CCD defect; pixel>0 in dead_ground_NxN.fit map
8	3	Hot Pixel identified; pixel>0 in hot_ground_NxN.fit map
16	4	Saturated pixel in raw data (A/D value of 4095)
32	5	Missing raw data (assume fill value of 0)
64 and higher	6-15	unused at present

Table 9-8 Quality flag value descriptions

9.3.7 Scientific Units

Following the convention adopted by the New Horizons Principal Investigator, the unit used for calibrated data product are “photometrically-corrected DN”. The procedure given above must be completed to obtain absolutely calibrated data products. The units adopted for the radiance (aka “intensity”) of diffuse targets are ergs/cm²/s/sr/Å. The units adopted for irradiance (aka “flux”) of point (i.e. unresolved) targets are ergs/cm²/s/Å. Wavelengths are quoted in angstrom units.

9.3.8 Additional FITS and PDS Keywords Added

Listed below are the keywords and sample values for those keywords that have been added to the FITS header and are stored with the primary HDU of the output calibrated image FITS file.

```

COMMENT *****
COMMENT *** LORRI Level 2 software name and version info ***
COMMENT *****
L2_SWNAM= 'lorri_level2_pipeline' /Level 2 calibration software
L2_SWVER= 'untagged' /software version tag
COMMENT *****
COMMENT *** LORRI Level 2 software logic flow control flags ***
COMMENT *****
IMGSUBTR= 'OMIT ' / image subtraction step
BIASCORR= 'PERFORM ' / bias subtraction step
SLINCORR= 'OMIT ' / signal linearization step
CTICORR = 'OMIT ' / charge transfer inefficiency step
DARKCORR= 'OMIT ' / dark subtraction step
    
```

```

SMEARCOR= 'PERFORM ' / smear removal step
FLATCORR= 'PERFORM ' / flat-fielding step
GEOMCORR= 'OMIT ' / geometric correction step
ABSCCORR= 'PERFORM ' / absolute calibration step
COMPERR = 'PERFORM ' / compute error estimate
COMPQUAL= 'PERFORM ' / compute quality flags
COMMENT *****
COMMENT *** LORRI Level 2 Reference Filename ***
COMMENT *****
REFDEBIA= 'sap_006_combined_100img_1x1.fit' / debias image filename
REFFLAT = 'cflat_grnd_SFA_20050309_v2.fit' / flat field image filename
REFDEAD = 'dead_ground_1x1_synthetic.fit' / dead pixel image filename
REFHOT = 'hot_ground_1x1_synthetic.fit' / hot pixel image filename
REFSUBIM= ' ' / subtraction image filename
COMMENT *****
COMMENT *** LORRI Level 2 Absolute Calibration Parameters ***
COMMENT *****
PIVOT = 6076.20019531 / LORRI pivot wavelength. units=angstroms
RSOLAR = 266400.000000 / Conv to radiance for solar source
RPLUTO = 257500.000000 / Conv to radiance for pluto source
RPHOLUS = 324300.000000 / Conv to radiance for 5145 pholus source
RCHARON = 263000.000000 / Conv to radiance for charon source
RJUPITER= 234700.000000 / Conv to radiance for jupiter source
PPLUTO = 1.03000005170E+16 / Conv to irradiance for pluto source
PSOLAR = 1.06600003807E+16 / Conv to irradiance for solar source
PPHOLUS = 1.29700002225E+16 / Conv to irradiance for 5145 pholus source
PCHARON = 1.05199994793E+16 / Conv to irradiance for charon source
PJUPITER= 9.38600033786E+15 / Conv to irradiance for jupiter source
PHOTZPT = 18.9400000000 / Zero point for visual magnitude, V
COMMENT *****
COMMENT *** LORRI Level 2 Calibrated telemetry items ***
COMMENT *****
EPU_P5VO= 5.04305504857 / EPU +5 voltage. units=Volts
EPU_P5CU= 0.143143000000 / EPU +5 current. units=Amps
FPU_P15V= 15.0005851594 / FPU +15 voltage. units=Volts
FPU_P15C= 0.049382700000 / FPU +15 current. units=Amps

```

```

FPU_P6_V=      6.05666080780 / FPU +6 voltage. units=Volts
FPU_P6_C=      0.152152000000 / FPU +6 current. units=Amps
FPU_HTRC=      0.00000000000 / FPU heater current. units=Amps
EPU_25PV=      2.50943456804 / EPU +2.5 voltage. units=Volts
RINGTEMP=     -66.8836898878 / Intermediate ring temp. units=celsius
MFOOTTMP=     -61.8964797242 / Mounting foot-top temp. units=celsius
M2MNTTMP=     -66.8836898878 / M2 mirror mount temp. units=celsius
RADTEMP =     -88.9564863168 / Radiator temp. units=celsius
BAFATEMP=     -62.9653774259 / Baffle-aft temp. units=celsius
BAFFTEMP=     -70.8007466057 / Baffle-forward temp. units=celsius
M1SUPTMP=     -67.2398321861 / M1 mirror support temp. units=celsius
M1MIRTMP=     -66.5275372052 / M1 mirror temp. units=celsius
CCDTEMP =     -79.5485000000 / CCD temperature. units=celsius
M1VFTEMP=     -66.0128183000 / M1 V/F temperature. units=celsius
M2VFTEMP=     -66.3287025000 / M2 V/F temperature. units=celsius
FPUBTEMP=      29.5499120000 / FPU board V/F temp. units=celsius
STEMPCVR= 'ENABLE ' / Temperature conversion enable
SCLMP2PE= 'OFF ' / Cal lamp 2 power enable
SCLMP1PE= 'OFF ' / Cal lamp 2 power enable
SSOURCE = 'CCD ' / Image source
SFORMAT = '1X1 ' / Image format
SEXPMODE= 'MANUAL ' / Exposure mode
PDUNAME = 'Level 2 LORRI image' /

```

9.3.8.1 Reading FITS file contents using IDL

The main method for accessing the various extensions and headers from the FITS file within IDL rely on a third-party library known as the Goddard Astron library. From within IDL, one can load the primary HDU from a fits file using the following command:

```

IDL> calimg=readfits('lor_0035015237_0x630_sci_1.fit', hdr )
IDL> help, calimg
CALIMG      FLOAT   = Array[1024, 1024]

```

The return value of this function (“calimg”) is a two dimensional array containing the image data from the primary HDU and its type depends on the data that is read from the file. In the case of raw data, it will be a 16-bit integer array and for calibrated data, it will be a 32-bit floating-point array. The first argument in the call to readfits() is the name of the FITS file to be read. The second argument is an ASCII string variable that will contain the FITS header for the primary HDU upon completion of the function.

The same function may be used in order to read any of the extensions listed in the files. For example, to read the data quality image from the calibrated FITS file, one would use a statement such as:

```
IDL> quality=readfits('lor_0035015237_0x630_sci_1.fit', hdr2, exten_no=2)
IDL> help, quality
QUALITY      UINT      = Array[1024, 1024]
```

In this example, the ASCII string variable “hdr2” contains the FITS header associated only with the second extension and has no portion of the header from the primary HDU.

9.3.9 Hardware/OS Development Platform

The pipeline software was developed in a variety of environments with the commonality of unix-style operating systems. There are no dependencies on the endian properties of the environment.

9.3.10 Language(s) Used

IDL

9.3.11 Third Party Libraries Required

There are two third party IDL libraries that are needed by the calibration pipeline software:

- 1) Goddard Astron library, which contains routines needed to read and write FITS files, the format used by the raw data files. Because this library is provided by the SOC for use by many instruments, we will not be delivering this library, but will rely on the version provided to us.
- 2) IDLUSR, a collection of useful IDL routines made available for public release at APL. Information about this library can be found at <http://fermi.jhuapl.edu/s1r/idl/idl.html>

9.3.12 Calibration Files Needed (with Quantities)

There are currently five categories of reference files needed to perform the calibration process. The reference image categories are the delta-bias, flat-field, dead pixel, hot pixel and desmear e-matrix. Because the LORRI instrument can produce images in either 1024 x 1024 mode or 256 x 256 mode, there are two varieties of each of these images. The filenames associated with these images will be obvious by inspection, although no formal file naming convention has been adopted.

There are two ASCII description files in the calibration directory that don't qualify as calibration files but are related to the operation of the pipeline. The first is a configuration file that details all of the configuration parameters for the pipeline (“default_config.txt”). The other file is a description of the housekeeping items that are stored in the first 34 pixels (51 bytes) of the raw image data (“binary_lorri_image_hdr.txt”). These values can be used to validate the FITS header tags that were produced by associating the high-speed image data with the low-speed telemetry values. The values in the first 34 pixels are guaranteed to be correctly associated with a particular image (provided they were not compressed in a lossy fashion) because the LORRI ASE put them in place prior to the transfer of the image data to the SSR. As such, they represent a valuable check of the telemetry processing performed on the ground after receipt.

The following is a table of the types of files in the calibration directory:

<i>Description</i>	<i>Quantity</i>	<i>1x1 filesize</i>	<i>4x4 filesize</i>
delta bias	2	~ 8 MiB	~0.5MiB
flat field	1	~ 8 MiB	~0.5MiB
hot pixel map	1	~ 8 MiB	~0.5MiB
dead pixel map	1	~ 8 MiB	~0.5MiB
desmear e-matrix	1	~ 8 MiB	~0.5MiB
pipeline configuration file	1	~5KiB	
LORRI header description	1	~4KiB	

9.3.13 *Memory Required*

~ 100 MiB

9.3.14 *Temporary File System Space Needed*

None

9.3.15 *Predicted Size of Output File(s)*

<i>Image dimensions</i>	<i>Binning</i>	<i>binmode</i>	<i>Expected File Size</i>
1024 x 1024	1x1	0	~ 10.5 MiB
256 x 256	4x4	1	~ 700 KiB

9.3.16 *Predicted Execution time*

Less than 30 seconds per image.

9.3.17 *Contact/Support Person(s)*

Raw data support: Howard Taylor, John Hayes, and Hal Weaver

Calibrated data support: Howard Taylor and Hal Weaver

9.3.18 *Maintenance Schedule (Code/Data Updates, Documentation)*

As in-flight calibration data are collected and analyzed, certain aspects of the calibration pipeline will require updates, either in the form of updated reference files, or updated code for bug fixes or future improvements.

9.4 **References**

A. F. Cheng, H. A. Weaver, S. J. Conard, M. F. Morgan, O. Barnouin-Jha, J. D. Boldt, K. A. Cooper, E. H. Darlington, M. P. Grey, J. R. Hayes, K. E. Kosakowski, T. Magee, E. Rossano, D. Sampath, C. Schlemm, H. W. Taylor, "LONG-RANGE RECONNAISSANCE IMAGER ON NEW HORIZONS", in Space Science Review, in press(2007)

S. Conard, F. Azad, J. Boldt, A. Cheng, K. Cooper, E. Darlington, M. Grey, J. Hayes, P. Hogue, K. Kosakowski, T. Magee, M. Morgan, E. Rossano, D. Sampath, C. Schlemm, and H. Weaver, "Design and fabrication of the New Horizons Long-Range Reconnaissance Imager," in Astrobiology and Planetary Missions, G. R. Gladstone, ed., Proc. SPIE 5906, 2005.

F. Morgan, S.J. Conard, H.A. Weaver, O. Barnouin-Jha, A.F. Cheng, H.W. Taylor, K.A. Cooper, R.H. Barkhouser, R. Boucarut, E.H. Darlington, M.P. Grey, I. Kuznetsov, T.J. Madison, M.A. Quijada, D.J. Sahnou, and J.M. Stock, "Calibration of the New Horizons Long-Range Reconnaissance Imager," in Astrobiology and Planetary Missions, G. R. Gladstone, ed., Proc SPIE 5906, 2005.

10. MVIC INSTRUMENT DESCRIPTION:

10.1 Overview

The Ralph instrument consists of two sets of focal planes: MVIC a visible, near-IR imager and LEISA, a short-wave IR spectral imager. This document only relates to the MVIC (Multispectral Visible Imaging Camera) part of the Ralph instrument. The LEISA pipeline is described in a different document (*New Horizons SOC to Instrument Pipeline ICD LEISA Edition*). There are 7 separate CCD arrays in the MVIC focal plane. The MVIC telemetry is communicated via a low-speed interface and the imaging data uses a high-speed interface.

Figure 10-1 shows a model of Ralph in the spacecraft coordinate system. The MVIC detector package is the light blue box on the +Y face of the instrument.

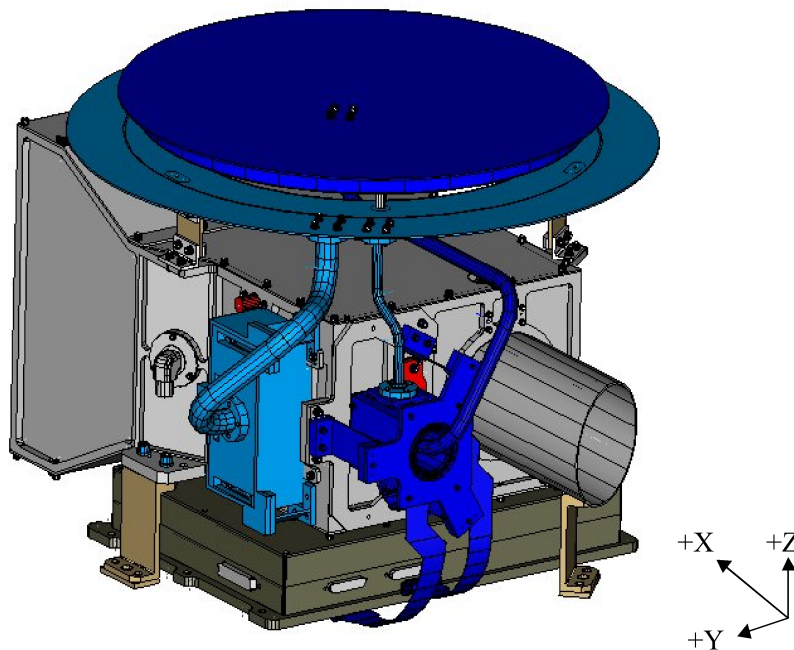

Figure 10-1: A model of Ralph in the spacecraft coordinate system. The Ralph aperture points in the $-X$ direction, the normal to the radiator is in the $+Z$ direction and the SIA points in the $+Y$ direction.

Data recorded on New Horizons is sent to the ground via the Deep Space Network. From there the data is sent to the Mission Operations Center (MOC) at the Applied Physics Laboratory (APL). The Science Operations Center (SOC) retrieves new data from the MOC daily. The data is in a raw form (packetized). The Level 1 and 2 software pipelines convert the data from these raw packets into FITS (Flexible Image Transport) files with scientifically useful and calibrated data. The Level 1 processing sorts the packets into images (in the case of MVIC) with useful header keywords. These keywords include the mode or filter of the observation, timing information and basic pointing information of the instrument boresight.

The Level 1 processing also adds relevant housekeeping telemetry (temperatures, voltages, etc.) in a binary table as an extension to the FITS file. The Level 2 processing performs the basic scientific calibration.

Before we get into a description of the MVIC calibration, we will describe the image formats for each of the CCD arrays that comprise MVIC. There are 8 detectors in the Ralph instrument. Seven of those are part of MVIC (the yellow and blue ones). The boresight information in Figure 10-2 is from ground-testing and will change in the future.

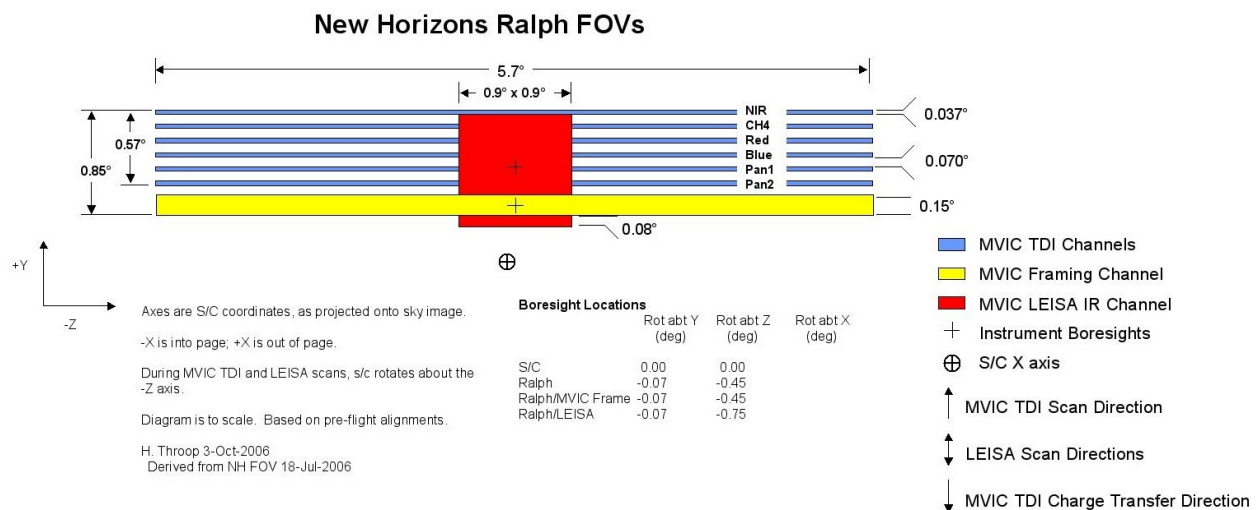

Figure 10-2: RALPH Fields-of-view

The "Pan Frame" array (yellow) has 5024x128 pixels. The first and last 12 pixels in each row are not optically active. When observing with the pan frame array, multiple images are recorded in each observation. Correspondingly, we store these images together in one FITS file. The first three letters of these files are "mpf" standing for MVIC pan frame. The images are stored as an image cube (3-dimensions). The first dimension is the column number, the second dimension is the row number and the third dimension is the image number within that observation.

The remaining 6 arrays are operated in a Time-Delay Integration mode (TDI). These arrays have 5024x32 pixels. The first and last 12 pixels in each row are not optically active. To take an observation with the TDI arrays, we scan the spacecraft and (typically) clock the charge through each of the 32 rows at a rate that matches the spacecraft's scan rate. Using this method we can build up arbitrarily long images in the row direction. For the "Pan 1" and "Pan 2" (panchromatic -- unfiltered) detectors, the resulting FITS files are standard 2-dimensional images. The first three letters of these files are either "mp1" or "mp2" corresponding to MVIC pan 1 or MVIC pan 2. The color arrays (NIR, CH4, Red and Blue) are operated together and they use a time-delay integration to build up images. The data for each filter is stored in separate FITS files.

In Table 10-1 below the variable "Ni" stands for the number of images in a pan frame observation. When we command a pan frame observation, we always take multiple images. The "Nr" in the table is the

number or rows in an observations. This is determined by the length of time that we are recording data and the rate that we clock the rows in TDI mode.

Detector	Prefix for FITS file	Dimensions of data in FITS file
Pan Frame	Mpf	3 (5024 x 128x Ni)
Pan 1	mp1	2 (5024 x Nr)
Pan 2	mp2	2 (5024 x Nr)
Red	mc0	2 (5024 x Nr)
Blue	mc1	2 (5024 x Nr)
NIR	mc2	2 (5024 x Nr)
CH4	mc3	2 (5024 x Nr)

Table 10-1: Observation Modes and their filename prefixes and data dimensions

The Level 2 FITS file has a primary data unit (PDU) which contains the bias-subtracted, flattened image (or image cube in the case of pan frame) plus 2 extensions. Extension 1 is an array with the per pixel error of the bias-subtracted, flattened image (or image cube). Extension 2 is an array with a data quality flag for each pixel of the bias-subtracted, flattened image (or image cube). See Tables 10-2 and 10-3.

FITS Data Unit	Dimension	Description
Primary (PDU)	5024 x 128 x Ni	Bias-subtracted and flattened image cube
Extension 1	5024 x 128 x Ni	1-sigma error per pixel in PDU image
Extension 2	5024 x 128 x Ni	Data quality flag of Level 1 PDU image

Table 10-2: Level 2 Pan Frame Image Data Format

FITS Data Unit	Dimension	Description
Primary (PDU)	5024 x Nr	Bias-subtracted and flattened image
Extension 1	5024 x Nr	1-sigma error per pixel in PDU image
Extension 2	5024 x Nr	Data quality flag of Level 1 PDU image

Table 10-3: Level 2 TDI Image Data Format

10.2 Level 1 Specifics

10.2.1 Data Format

The Level 1 MVIC files will be FITS files. Details of the dimensions of the FITS images and header keywords are given in the following sections.

10.2.2 Data Sources (*High/Low Speed, CCSDS, ITF*)

MVIC telemetry data are recorded using the low-speed interface and images are recorded with the high-speed interface using CCSDS (Consultative Committee for Space Data Systems) packets. There are four Ralph-MVIC data formats:

- A. MVIC Panchromatic TDI (Time-Delay Integration) Format
- B. MVIC Panchromatic TDI Binning Format
- C. MVIC Color TDI Format
- D. MVIC Frame Format

Note the distinction between “format” and “mode” is a hold over from the spacecraft to Ralph ICD where the LEISA component of Ralph has multiple modes for one format. The MVIC Panchromatic TDI format has two modes (either “Pan 1” or “Pan 2” indicating which detector was used). The MVIC Panchromatic TDI binning format is obsolete and is not being supported at this time. The remaining two formats each have only one mode.

Table 10-4 lists the MVIC ApIDs (packet Application Process IDentifiers; also Application IDs) and their corresponding data types. For each data type there are two ApIDs, one for each C&DH (Command and Data Handling) system on the spacecraft.

ApID	Data Type
0x530	MVIC Panchromatic TDI Lossless (CDH 1)
0x53f	MVIC Panchromatic TDI Lossless (CDH 2)
0x531	MVIC Panchromatic TDI Packetized (CDH 1)
0x540	MVIC Panchromatic TDI Packetized (CDH 2)
0x532	MVIC Panchromatic TDI Lossy (CDH 1)
0x541	MVIC Panchromatic TDI Lossy (CDH 2)
0x533	MVIC Panchromatic TDI 3x3 Binned Lossless (CDH 1) *
0x542	MVIC Panchromatic TDI 3x3 Binned Lossless (CDH 2) *
0x534	MVIC Panchromatic TDI 3x3 Binned Packetized (CDH 1) *
0x543	MVIC Panchromatic TDI 3x3 Binned Packetized (CDH 2) *
0x535	MVIC Panchromatic TDI 3x3 Binned Lossy (CDH 1) *
0x544	MVIC Panchromatic TDI 3x3 Binned Lossy (CDH 2) *
0x536	MVIC Color TDI Lossless (CDH 1)
0x545	MVIC Color TDI Lossless (CDH 2)
0x537	MVIC Color TDI Packetized (CDH 1)
0x546	MVIC Color TDI Packetized (CDH 2)
0x538	MVIC Color TDI Lossy (CDH 1)
0x547	MVIC Color TDI Lossy (CDH 2)
0x539	MVIC Panchromatic Frame Transfer Lossless (CDH 1)
0x548	MVIC Panchromatic Frame Transfer Lossless (CDH 2)
0x53a	MVIC Panchromatic Frame Transfer Packetized (CDH 1)
0x549	MVIC Panchromatic Frame Transfer Packetized (CDH 2)
0x53b	MVIC Panchromatic Frame Transfer Lossy (CDH 1)
0x54a	MVIC Panchromatic Frame Transfer Lossy (CDH 2)

Table 10-4: ApID and Data Type for MVIC Data

*Note that the Panchromatic TDI Binned data is 3x1 binning in the cross-track direction with 2 out of 3 along-track lines discarded.

Note there is not a different ApID for PAN1 and PAN2 observations. This information is stored in the low-speed housekeeping data (keyword MODE). This information is inserted into the FITS header of the Level 1 FITS file. A value of 3 means that the observation was taken with the “Pan 1” array and a value of 4 indicates the “Pan 2” array was used. For more information, see the Ralph Users Manual.

The Pan Frame detector has 5024x128 pixels. The first and last 12 pixels in each row are not optically active. When observing with the pan frame array, multiple images are recorded in each observation. Correspondingly, we store these images together in one FITS file. The first three letters of these files are "mpf" standing for MVIC pan frame. The images are stored as an image cube (3-dimensions). The first dimension is the column number, the second dimension is the row number and the third dimension is the image number within that observation.

The remaining 6 arrays are operated in a time-delay integration mode (TDI). These arrays have 5024x32 pixels. The first and last 12 pixels in each row are not optically active. To take an observation with the TDI arrays, we scan the spacecraft and (typically) clock the charge through each of the 32 rows at a rate that matches the spacecraft's scan rate. Using this method we can build up arbitrarily long images in the row direction. For the "Pan 1" and "Pan 2" (panchromatic -- unfiltered) detectors, the resulting FITS files are standard 2-dimensional images. The first three letters of these files are either "mp1" or "mp2" corresponding to MVIC pan 1 or MVIC pan 2. The color arrays (NIR, CH4, Red and Blue) are operated together and they use a time-delay integration to build up images. The data for each filter is stored in separate FITS files.

10.2.3 Definition of an “Observation”

For this ICD and as is consistent with the “New Horizons Spacecraft to PERSI/RALPH Interface Control Document”, an “observation” is a coherent sequence of data-taking operations, with data reported over the high-speed telemetry interface conducted automatically after being initiated by telecommands from the C&DH system. The observation may end automatically, or may run until a telecommand ends it.

All observations consist of one or more “frames.” A “frame” is the amount of high-speed image data between returns of the +frame signal to the high state. All frames consist of a sequence of “words”. A word is a pixel and is 12 bits in length.

10.2.4 Housekeeping Needed in Level 1 Files (for Calibration)

There are some housekeeping values that we need to track for the health of MVIC and to assess the data quality. We need to monitor these keywords during Ralph observations. The Ralph telemetry will be sent each second during an MVIC observation and these keywords will be stored as a binary table in EXTENSION 1 of the Level 1 FITS file. They will be used to set the data quality flag if the value exceeds its yellow limit. The red and yellow limits in Table 10-5 are pre-launch limits and will be updated as needed.

Mnemonic	Yellow Low Limit	Yellow High Limit	Red Low Limit	Red High Limit
RALPH_HK2.POS_12V	11.75	12.25	11.5	12.5
RALPH_HK2.NEG_12V	-12.25	11.75	-12.5	11.5
RALPH_HK2.POS_5V	4.75	5.25	4.5	5.5
RALPH_HK2.NEG_5V	-5.25	-4.75	-5.5	-4.5
RALPH_HK2.POS_30V	29.75	30.25	29.5	30.5
RALPH_HK2.MVIC_TEMP	-144	26	-150	30
RALPH_HK2.MVIC_VRD	1.9	2.1	1.8	2.2
RALPH_HK2.MVIC_VOD	1.9	2.1	1.8	2.2
RALPH_HK2.MVIC_VOG	1.9	2.1	1.8	2.2

Table 10-5: Housekeeping Limits (pre-launch)

10.2.5 Raw Science Data and/or Housekeeping Requirements

There are no additional raw science data requirements beyond those already specified.

Ralph housekeeping data are stored in a binary table extension.

Ralph-specific keywords in the Level 1 file are given in Table 10-6.

Keyword	Description
MET510	the MET of the Ralph 0x510 packet that marks the start of an observation
TRUE510	Is the 0x510 real or assumed from a gap?
RALPHEXP	RALPH exposure time (s)
MODE	Instrument mode
SIDE	Instrument HW side
DETECTOR	Detector used
FILTER	CCD filter color ¹
SCANTYPE	Type of scan done

Table 10-6: Level 1 file keywords for RALPH

For the MVIC pan frame data, the standard keywords describing the pointing and mid-exposure time are repeated for each image in the image cube.

10.3 Level 2 Specifics

10.3.1 Algorithm for Pipeline

There are four processing steps applied to the Level 1 MVIC data to produce the Level 2 output:

1. Remove bias and flat-field pattern.
2. Convert from DN to physical units (via header keywords).
3. Calculate error for each pixel and construct the error array in a new extension.
4. Construct data quality extension.

Note there will not be any correction for scattered light (at least initially) in the Level 2 products. A complete assessment of the scattered light field will be made in flight, and corrections will be implemented if necessary. Also, there is no correction for cosmic rays in the Level 2 product.

We do not apply the Level 2 calibrations to the non-optically active pixels of the detector to maintain our high-speed header data which is encoded in some of these pixels.

Geometric and motion distortion corrections are Level 3 products and not part of the Level 2 pipeline.

10.3.1.1 Remove bias and flat-field pattern

First, the removal of the bias level and flat-field pattern for the framing array will be discussed, and then we will address modifications for the TDI modes.

For the “Pan Frame” data, we use the shielded pixels on both sides of the array to compute the row-by-row bias. For column numbers 12 to 2511 (the active area on the left half of the chip), the bias is the median of pixels in columns 2 to 11 (inclusive and zero-based). Similarly, the bias for pixels from column numbers 2512 to 5011 (the active area on the right half of the chip) comes from the shielded pixels in columns 5012 to 5021 (inclusive and zero-based). We do not include the pixels closest to the edge of the array as they contain the high-speed header information.

For the TDI mode, only pixels on one side of the image would be usable as bias level. The others are used for charge injection and do not represent the bias level. However, if we only use pixels from one side of the array we do not get a good model of the bias level. Instead we assume a fixed value of 24 DN for the bias level for all TDI arrays.

The correction for the bias level and flat-field pattern are described here. Let B be the bias level, R is the raw image, and F is the normalized flat-field image:

We calculate the corrected image, R_f :

$$R_f = \frac{R - B}{F} \quad (2)$$

The name of the flat field file used will be stored in the header keyword FLAT. The naming convention for the flats will be unique. Each file name will contain the name of the array as well as the date (i.e. “flat_mvic_pan1_20050612.fits” or “dark_mvic_colorBlue_20050612.fits”).

For our purposes, the dark current is expected to be negligible.

For the TDI exposures, the flat field image is one-dimensional since each pixel in a given column is clocked through all 32 rows before being read out. This one-dimensional flat field has the dimensions of a single row in the TDI image. Instead of dividing the TDI image by a two-dimensional normalized flat, we will be dividing each row by the normalized (1-dimensional) flat. There will be 6 different flat-field one-dimensional arrays: 4 color and 2 panchromatic. There will only be one 2-D flat field image (for the framing array).

The function that constructs the flattened, bias-subtracted image (Eq. 2) is called **mvic_flatten**. The function will determine what imaging mode was used (pan1, pan frame, etc), use the appropriate median flat field image, and produce an image with the bias subtracted, and flat field pattern removed. This image (or image cube, in the case of the pan frame detector) is stored in the primary data unit (PDU) of the Level 2 FITS file.

10.3.1.2 Conversion to Physical Units

We are using the same standard method as used by the LORRI instrument for conversion to physical units.

In order to determine the conversion to physical units, we need to know the spectral type of the target.. We have determined the conversion factor for 4 different spectral types: Pluto, Charon, Jupiter, Solar and

Pholus. The absolute calibration is given by a keyword (i. e., RPLUTO) in the header of the Level 2 file that allows the user to convert a count rate (“C/TEXP” in DN/s/pixel, where “C” is the flat-fielded signal in a pixel and “TEXP” is the exposure time in seconds) for a resolved source into a radiance value (“I” in ergs/cm²/s/sr/Å) at MVIC’s pivot wavelength (specified by the FITS keyword PIVOT; see below), assuming that the spectrum of the target is identical to the globally-averaged spectrum of Pluto. The relevant formula is:

$$I = C/TEXP/RPLUTO$$

The keyword RPHOLUS allows the conversion of the count rate for a resolved source into a radiance value at the pivot wavelength assuming that the target has a spectral distribution identical to that of the centaur object 5145 Pholus, which may be a good analog for the reddest regions on Pluto:

$$I = C/TEXP/RPHOLUS$$

Similarly, the keywords RSOLAR, RJUPITER and RCHARON provide the conversion factors for resolved targets with Solar-, Jupiter- or Charon-like spectra. Table 10-7 gives the values of the multiplicative factor (RSOLAR, RJUPITER...) for resolved objects.

	Pan Frame	Pan1	Pan2	NIR	CH4	Red	Blue
RSOLAR	0.672	0.66 5	0.66 5	0.31 3	0.239	0.31 4	0.12 2
RJUPITER	0.662	0.65 6	0.65 6	0.30 9	0.239	0.31 2	0.12 2
RPHOLUS	0.730	0.72 3	0.72 3	0.31 4	0.240	0.31 6	0.12 2
RPLUTO	0.692	0.68 4	0.68 4	0.31 2	0.240	0.31 3	0.12 2
RCHARON	0.678	0.67 1	0.67 1	0.31 2	0.240	0.31 2	0.12 2

Table 10-7 The values $\times 10^5$ of the conversion factor (DN/s)/(ergs/cm²/s/sr/Å) for resolved objects. The first column is the FITS keyword in the MVIC Level 2 header

The pivot wavelength (PIVOT) is given by:

$$PIVOT = \sqrt{\frac{\int P\lambda d\lambda}{\int P d\lambda / \lambda}}$$

where “P” is the MVIC system quantum efficiency (i.e., fraction of photons detected) at wavelength “ λ ”. The pivot wavelength is passband specific and is stored in the FITS file header.

	Pan Frame	Pan1	Pan2	NIR	CH4	Red	Blue
WSOLAR	0.648	0.648	0.648	0.850	0.886	0.612	0.487
WJUPITER	0.636	0.636	0.636	0.842	0.884	0.612	0.489
WPHOLUS	0.701	0.701	0.701	0.856	0.887	0.620	0.489
WPLUTO	0.664	0.664	0.664	0.850	0.886	0.614	0.491
WCHARON	0.651	0.651	0.651	0.850	0.886	0.612	0.488

Table 10-8 The pivot wavelength in μm . The first column is the FITS keyword in the MVIC Level 2 header.

For unresolved sources (e.g., stars), the calibrated flux (also called “irradiance”) at the pivot wavelength can be determined using keywords that are defined analogously to the photometry keywords discussed above for resolved sources. In the case of a source having a spectral distribution identical to that of a globally-averaged Pluto spectrum, the observed count rate integrated over the MVIC PSF (“CINT/TEXP” in DN/s, where CINT is the total number of flat-field corrected counts integrated over the image and “TEXP” is the exposure time) can be related to the flux (“F” in $\text{ergs}/\text{cm}^2/\text{s}/\text{\AA}$) by:

$$F = \text{CINT}/\text{TEXP}/\text{PPLUTO}$$

Similarly, the flux at the pivot wavelength for a target having the same spectral distribution as Charon (PCHARON), the sun (PSOLAR), and Pholus (PPHOLUS) are given in the FITS header.

	Pan Frame	Pan1	Pan2	NIR	CH4	Red	Blue
<i>PSOLAR</i>	1.655	1.638	1.638	0.772	0.58 8	0.77 4	0.301
<i>PJUPITER</i>	1.632	1.616	1.616	0.763	0.58 9	0.76 6	0.300
<i>PPHOLUS</i>	1.799	1.781	1.781	0.776	0.59 1	0.77 6	0.300
<i>PPLUTO</i>	1.704	1.687	1.687	0.770	0.59 0	0.76 9	0.301
<i>PCHARON</i>	1.671	1.654	1.654	0.770	0.59 0	0.76 6	0.299

Table 10-9 The values $\times 10^{14}$ of the conversion factor (DN/s)/(ergs/cm²/s/Å) for unresolved (point-source) objects. The first column is the FITS keyword in the MVIC Level 2 header.

10.3.1.3 Error Propagation

The standard deviation of each pixel will be calculated and the resulting 2-D array of errors will be put into extension 1 of the Level 2 FITS file. The gain, g , and the DN value of each pixel of the distortion-removed flattened image (extension 1 in the FITS file) will be used to determine the photon noise. The photon noise and the read noise, RN , will be used to calculate the standard deviation per pixel in DN. The error equation :

$$\sigma = \frac{\sqrt{(P_{meas}/g) + (RN)^2 + (fP_{meas})^2}}{FF}$$

The gain (58.6 electrons per DN) and read noise (30 electrons) values used to calculate the standard deviation will be entered in the file header with the keywords GAIN and READNOI. We will also include the error propagation due to uncertainty in the flat field pattern. Other sources of error such as the uncertainty in the bias level are not included.

10.3.1.4 Data Quality Flags

The data quality flags will be set to a non-zero value if there is a problem with the data and zero if the data is fine. Below is a preliminary list of the factors that will cause the data quality flag to be set to its appropriate value. The data quality information is written into extension 2 of the Level 2 FITS file.

Quality Flag Value	Description
0	Good pixel
1	Housekeeping keyword out of yellow limits, see Table 10-5.
2	Defect in one of the reference calibration files
4	Permanent CCD defect (e.g., dead pixel)
8	DN level in non-linear regime of detector
16	Zero-value pixel
32	Bad pixel not in any of above categories
-1	Missing data

If a housekeeping keyword exceeds its yellow limit at any time during the exposure the data quality flag for all the pixels in the image are set to 1.

10.3.2 Dataflow Block Diagram

Here is a diagram that shows how the data flows through the different IDL procedures and functions that comprise the Level 2 pipeline.

```

;   mvicL2_pipeline
;   |
;   --mvic_level2_pipeline
;   |
;   --mvic_flatten
;   ||
;   | --pantdi_flatten
;   |||
;   || --pantdi_readflat
;   |||
;   || --tdi_flatten_core
;   ||

```



```
; | --mcl_flatten
; | | |
; | | --mcl_readflat
; | | |
; | | --tdi_flatten_core
; | |
; | --panfra_flatten
; |
; --mvic_dq
; | |
; | --pantdi_dq
; | |
; | --check_pixels
; | |
; | --pantdi_hk_check
; | | |
; | | --setUpAndScaleHK
; | | |
; | | --scaleRawRalphTelemetry
; | | |
; | | --conversionCoefsForMVIChk.pro
; | --panfra_dq
; | |
; | --panfra_check_pixels
; |
; |
; --mvic_err
; |
; --pantdi_err
; | |
; | --pantdi_readflat
```

```

;      |
;      --mcl_err
;      | |
;      | --mcl_readflat
;      |
;      --panfra_err

```

10.3.3 Data Format

All of the MVIC Level 2 FITS files have a primary data unit and two extensions. In the primary data unit (PDU), the bias-subtracted, flattened data is stored. The first extension has the error array for the bias-subtracted, flattened data. The second extension has the data quality array for the bias-subtracted, flattened data.

The image data for the TDI observations is stored in a two-dimensional array. The number of columns in the array is always 5024. The number of rows in the array depends on the duration of the observation and the scan rate.

The image data for the pan frame observations is stored in a three-dimensional array (an image cube). The number of columns is always 5024, the number of rows is always 128.

Geometric and motion distortion corrections are not part of the Level 2 pipeline.

10.3.4 Scientific Units

We will be using cgs units for the Level 2 output. The flux per pixel will have the units of ergs/s/cm²/Angstrom or ergs/s/cm²/sr/Angstrom, for resolved and unresolved sources, respectively, after applying the scale factors in the FITS keyword described in Section 10.3.1.2.

10.3.5 Additional FITS and PDS Keywords Added

Additional FITS keywords added to the Level 2 product include:

```

SOCL2VER= '2.0      ' /Version of Level 2 software
PIXSIZE  =          13.0000 /Pixel size in microns
PIXFOV   =          19.8000 /Single pixel field of view in microradians
READNOI  =          30.0000 /Readnoise in Electrons
GAIN     =          58.6000 /Gain in Electrons/DN
CALDIR   = 'cal/    ' /Directory for calibration files

```

PJUPITER =	$/(DN/s)/(erg/cm^2/s/\text{\AA}),$ Jupiter spectrum
PPHOLUS =	$/(DN/s)/(erg/cm^2/s/\text{\AA}),$ Pholus spectrum
PPLUTO =	$/(DN/s)/(erg/cm^2/s/\text{\AA}),$ Pluto spectrum
PSOLAR =	$/(DN/s)/(erg/cm^2/s/\text{\AA}),$ Solar spectrum
RJUPITER =	$/(DN/s)/(erg/cm^2/s/\text{\AA}/sr),$ Jupiter spectrum
RPHOLUS =	$/(DN/s/pix)/(erg/cm^2/s/\text{\AA}/sr),$ Pholus spectrum
RPLUTO =	$/(DN/s/pix)/(erg/cm^2/s/\text{\AA} /sr),$ Pluto spectrum
RSOLAR =	$/(DN/s/pix)/(erg/cm^2/s/\text{\AA} /sr),$ Solar spectrum
WPIVOT =	/cm, pivot wavelength

The values of the radiometric keywords are source-dependent as discussed above.

10.3.6 Extra FITS Extensions() and Their Definitions

There are four extra FITS extensions. The first three have been described in detail previously (the distortion-removed image file, the error array and the data quality flag array). The fourth extension is the binary table with the housekeeping data. This data is simply passed along from the Level 1 file without modification.

10.3.7 Hardware/OS Development Platform

The Level 2 software will be developed on a PowerBook G4 running Mac OS X version 10.3.4. Future Migration will be backwards compatible.

10.3.8 Language(s) Used

The MVIC Level 2 software will be written using IDL.

10.3.9 Third Party Libraries Required

The code will require the “IDL Astronomy User’s Library”. It is available from <http://idlastro.gsfc.nasa.gov/homepage.html>.

10.3.10 Calibration Files Needed (with Quantities)

The following calibration files will be used.

- Flat field images for each array
- Bad pixel files for each array
- File with the acceptable levels of the housekeeping keywords that we are monitoring

There will probably be multiple generations of each over time during the mission. These files will be archived with the observations]

10.3.11 *Memory Required*

TBD

10.3.12 *Temporary File System Space Needed*

None.

10.3.13 *Predicted Size of Output File(s)*

The output files will be approximately twice as large as the input files since we are adding the multiple extensions, but not propagating the housekeeping.

10.3.14 *Predicted Execution time*

TBD

10.3.15 *Contact/Support Person(s)*

Cathy Olkin

Dennis Reuter

Leslie Young

10.3.16 *Maintenance Schedule (Code/Data Updates, Documentation)*

The code will be updated on the schedule mandated by the mission. The current plan is to do code maintenance after the Instrument Calibration (on the ground), after Integration and Test (on the ground), after Commissioning, and after the Jupiter Encounter. Calibration files will be updated throughout the mission as necessary. Necessary criteria include new calibration information (such as new flat-field observations or a new geometric distortion correction) such as might be available after an annual checkout.

11. PEPSSI INSTRUMENT DESCRIPTION

11.1 Overview

11.1.1 PEPSSI Investigation

PEPSSI (Pluto Energetic Particles Spectrometer Science Investigation) is a particle telescope and a time-of-flight (TOF) spectrometer that measures ions and electrons over a broad range of energies and pitch angles. Particle composition and energy spectra are measured for H to Fe from ~ 30 keV to ~ 1 MeV (but not all species are uniquely separated) and for electrons from ~ 30 keV to 700 keV.

The PEPSSI instrument traces its heritage back to the MESSENGER Energetic Particle Sensor (EPS) instrument. EPS/PEPSSI was developed with the support of a NASA Planetary Instrument Definition and Development (PIDDP) grant aimed at designing a low-mass, low-power sensor that can measure energetic pickup ions produced near planets and comets (Andrews *et al.*, 1998; McNutt *et al.*, 1996). The overall PEPSSI instrument weighs 1.5 kg and uses maximum power of 1.4 W.

Figure 11-1 shows the placement of PEPSSI on the spacecraft and the PEPSSI fields-of-view (FOV).

The science goals of the PEPSSI instrument are:

1. Determine the escape rate of Pluto's atmosphere
2. Measure the interaction of the solar wind with Pluto's ionosphere
3. Determine the source and nature of energetic particles found near Pluto

11.1.2 PEPSSI Sensor Description

PEPSSI is a compact particle telescope with a time-of-flight (TOF) section and a solid-state detector (SSD) array (see Figure 11-2). A mechanical collimator defines the acceptance angles for the incoming ions and electrons. A cutaway view of the assembly is shown in Figure 11-3. The TOF section is axially symmetric; entrance and exit apertures are 6 mm wide with an azimuthal opening angle of 160° . The entry and exit apertures are covered by thin (~ 7 $\mu\text{g}/\text{cm}^2$) polyimide/aluminum and (~ 10 $\mu\text{g}/\text{cm}^2$) palladium/carbon foil mounted on high-transmittance stainless-steel grids, respectively. The foil thickness and composition is a compromise to minimize the energy threshold, secondary electron production, and scattering of particles in the foil while blocking UV from the direct Sun and Lyman- α background. PEPSSI measures the ion TOF using secondary electrons generated as the ion passes through the entrance and exit foils in the spectrometer. Total energy is measured by the SSD array. Each of the six SSDs has two pixels, three of the SSDs are dedicated for ion measurement. The other three have one pixel covered with ~ 1 μm Al absorber, to block low energy ions and permit measurements of electrons. The fan-like collimator together with the internal geometry defines the acceptance angles. The FOV is 160° by 12° with six angular sectors of 25° each; the total geometric factor is ~ 0.15 cm^2sr . As an ion passes through the sensor, it is first accelerated by the potential of ~ 3 kV on the front foil prior to hitting it. The ion generates secondary electrons at the foils, which are then electrostatically steered to well-defined separate regions on a single micro channel plate (MCP), providing “start” and “stop” signals for the TOF measurements (from 1 ns to 320 ns). The segmented MCP anode, with one start segment for each of the six angular entrance segments, allows determination of the direction of travel even for lower-energy ions that do not give an SSD signal above threshold.

The combination of measured energy and TOF provides unique particle identification by mass and particle energy depending on the range: for protons from ~ 30 keV to ~ 1 MeV; for heavy (CNO) ions from

~80 keV to ~1 MeV. Lower-energy (>3 keV) ion fluxes are measured by TOF only, but without the SSD signal, providing velocity spectra at these energies as well. Molecular ions, expected from Pluto's atmosphere, will break up in the foil prior to their full detection, but will be detected as high-mass events. Internal event classification electronics determine the mass and produce an eight-point energy spectrum for each of four species for six arrival directions. Energetic electrons are measured simultaneously in the dedicated electron pixels in the range from ~30keV to 700 keV. Only protons with energies > 300 keV (expected to be very rare at Pluto) can penetrate the absorbers on these pixels, and even those would be eliminated by on-board MCP coincidence requirements and ground comparisons with the simultaneously measured ion flux.

11.1.3 PEPSSI Electronics Description

Extensive uses of miniaturization and custom electronic in the design allow PEPSSI to weigh less than 1.5 kg and consume less than 1.4 W. PEPSSI is made up of six modular 4"x4" slices. They consist of:

- 1) Energy board;
- 2) High Voltage Power Supply (HVPS);
- 3) TOF board;
- 4) Digital processing board;
- 5) Common event processor board; and
- 5) Low Voltage Power Supply (LVPS) board.

Figure 11-4 shows the exploded view of PEPSSI with each board labeled. A brief description of the functionality of each board is highlighted below.

Energy board:

The energy board is the interface between the SSDs and the signal conditioning electronics. It houses the sensor, MCP anodes, charge amplifiers, pulse shapers, etc. In addition, it also outputs the pulse signal from the 6 start anodes and 1 stop anode.

HVPS board:

The HVPS board contains the high voltage (HV) drive circuitry, HV transformer, and its control circuitry. It provides HV up to -2900 V for the sensor electrostatic lens and MCP bias. In addition, the HVPS also needs to provide bias voltage over the range of 0 to -200 V with <10 mV ripple.

Digital processing board:

The digital processing board provides valid event logic functions, which include channel enables, programmable coincidence window, event packet generation and rate counters for event statistics. It provides the logic to distinguish between electrons, ions and directionality.

Common event processor board:

This board contains PEPSSI's main processor (RTX2010RH), the Filed Programmable Gate Array (RT54SX72S), and various memory modules (SRAM, EEPROM, PROM).

LVPS board:

This board converts primary spacecraft power into multiple low voltage outputs used by PEPSSI. It provides highly efficient power conversion into two digitals (+5, +2.5V) and four analogs (+5, -5, +15, and -15) outputs.

11.2 Introduction to PEPSSI Data

The PEPSSI instrument can operate in two modes: Normal and Diagnostic. On the spacecraft, each event generates a PHA record. This record is classified by event type: Electron, High-Energy Ion (or “Hi-Ion” or “Triple”), or Low-Energy ion (or “Low-Ion,” “Double,” or “TOF-only”). In diagnostic mode, events are not classified; alternatively, all events are “diagnostic events”. Events of a given type are further classified into “Rate Boxes” by their energy and/or time of flight (TOF). Thus each event has a type, a rate box, and a detector in which it occurred. Instead of detector number, we will often use arrival direction (or sector) since there is a one to one relation between them (see Figure 11-5). A six character string is used to specify each possible classification (or Rate) of an event. The construction of this string is (type)(rate box)S(arrival sector). The arrival sector numbering is shown in Figure 11-5. The “type” string is:

B – Hi-Ions (possesses Energy and TOF)

R – Electrons (energy only, no TOF)

L – Low-Ions (TOF-only, no-energy).

For High Energy Ions, the “Rate Boxes” are determined by areas in the TOF vs Energy plane (see Figure 11-6). These correspond to different particle species and different energies.

For Electrons, the “Rate Boxes” are determined by energy ranges.

For Low Energy Ions, the “Rate Boxes” are determined by TOF ranges *and* by which heavy ion discriminators fired. The definition of Low-Ion “Rate Boxes” has been changed for the post-Jupiter phases of the mission. Note that because of the way the PEPSSI electronics work, frequently the arrival sector is unknown or uncertain for the Low-Ion measurements.

Some examples:

B02S04 – High-Energy Rate Box #2, arriving from the sector 4 direction. Protons with deposited energy in channels 95-169, in analog-to-digital units(ADUs).

L06S03 – Low-Ions Rate # 6 arriving from the sector 3 direction. Ions with TOF indices from 45-79 ADUs and for which the heavy ion discriminator H0 fired but H1 didn't.

R00S05 – The 0th electron rate, arriving from the sector 5 direction. Electrons with Energy channels in the range 720-1023 ADUs.

There are two counters for each Rate that are incremented whenever a corresponding event occurs. The N2 counter is accumulated for a certain time interval (programmable down to 1 second during the Pluto encounter but typically 15-60 seconds during cruise), then recorded and zeroed. The N1 counter is accumulated for some multiple of the N2 interval (usually 10 minutes during cruise), then recorded and zeroed. A certain number of PHA events are kept according to a complex priority scheme and telemetered along with the Rate data. (Note: if the multi-hit, i.e. anti-coincidence, flag is set for an event, the event is *not* counted. This is programmable, but the “don't count multi-hit events” rule was true outside of Bad Time Intervals for the whole Jupiter phase).

Various housekeeping and status data and certain global hardware and software counters are also present in the data at Levels 1 and 2.

PEPSSI Level 1 and PEPSSI Pre-Level 2 data are internal formats that are not used outside the SOC.

PEPSSI Level 2 data represents, with 3 exceptions, the raw data taken from the spacecraft telemetry. It has merely been reformatted for ease of use. No data has been added, removed or altered with the following 3 exceptions:

- a. Instrument Status information has been calibrated to physical units where applicable (see discussion in section 11.4 below).
- b. For clarification, a “DT” column has been added to the Rate tables to indicate the integration time over which the count data was accumulated. This information is not available in the spacecraft telemetry and must be calculated from the available timestamps. This “DT” value may be inaccurate during Bad Time Intervals (BTIs), see below.
- c. For ease of use, we have added a column giving the deduced “Rate Box” of High-Ion PHA and Electron PHA events to the Level 2 PHA data. While this can, in principle, be calculated from the raw Level 2 quantities and the RATEBOXDEFINITIONPLANES.FIT file available in the CALIB/ directory of the PDS archive, the procedure is complex enough that we have found it convenient to perform this calculation in advance and include the information in the Level 2 files.

PEPSSI Level 3 data presents the data in a format that should be convenient for scientific analysis. All of the calibration parameters needed to convert Level 2 data to Level 3 data are present in the headers of the Level 3 data files. The formulas used to calculate the calibrated quantities are also present in the Level 3 headers.

Rate data is presented in physical flux units with uncertainties as well as counts per second.

PHA data is presented with calibrated TOF and deposited energy. Further calibrated incident energies are given for assumed ion species. Only PHA data telemetered with the N2 rates is present in Level 3 as discussed below. There are also some “quick look” PHA images and Rate spectrograms in the Level 3 data to allow for a simple overview of each “day's” (see below) observations.

No “multi-hit” events are present in Level 3 PHA data. No diagnostic mode data is present in the Level 3 data. BTI data *is* present in the Level 3 data but should be ignored. Level 3 data for the “Launch” phase is present for quick-look purposes, but, apart from the deposited energy calibration (which is well known), the calibrations are performed with dummy values, as will be evident from examination of the header information.

Note: End users of PEPSSI data (i.e. those outside the instrument team and the SOC) will probably not find much useful information in the Level 1 and Pre-Level 2 documentation which follows and are encouraged to skip directly to section 11.4.3, Level 2 Data.

11.2.1 Effect of Spacecraft Spin

Because New Horizons is not a pure “spinning” spacecraft, PEPSSI data does not have specific adaptations available for data taken while the spacecraft is spinning. For event data, the timestamp and sampling period are too coarse to accurately correlate any given event with a specific spacecraft attitude.

For rate data, since the data accumulation periods rarely “line up” precisely with the start and end of a spin, there will typically be some spin-modulation of the measured rates due to sample aliasing.

For example, N2 counter accumulation data timestamped at 15s sampling intervals while the spacecraft is spinning at ~12s per revolution (5RPM) would sample the same 90 degrees of sky (3s of a revolution) twice per sampling interval, but would sample the other 270 degrees of sky only once per sampling interval.

11.3 Level 1 Specifics

The SOC Level 1 data product is a FITS format data file and all data is contained in FITS extension Header Data Units (HDUs). Each HDU contains a PEPSSI science data telemetry block which is described in depth in the PEPSSI Flight Software Specification. Level 1 files are not present in the PDS archive. There are

File Type	HDU Type
N1	Primary HDU: High Priority Telemetry Block Extension 1: PHA Telemetry Block Extension 2: Status Telemetry Block
N2	Primary HDU: Medium Priority Telemetry Block Extension 1: PHA Telemetry Block Extension 2: Status Telemetry Block
N3	Primary HDU: Low Priority PHA Telemetry Block

11.3.1 Data Sources (High/Low Speed, CCSDS, ITF)

PEPSSI is low-speed only. Data will be from CCSDS (Consultative Committee for Space Data Systems) packets.

11.3.2 Definition of an “Observation”

PEPSSI doesn’t make specific “Observations”.

11.3.3 Header with Keywords

This section has intentionally left blank as of early 2014, but may be filled in at a later date.

11.3.4 Spacecraft Housekeeping Needed in Level 1 Files (for Calibration)

Spacecraft attitude is necessary to calculate PEPSSI pointing in the ecliptic coordinate system, and with respect to Jupiter, Pluto, and Charon. An accuracy of 1 degree is adequate.

11.3.5 Raw Science Data and/or Housekeeping Requirements

No special requirements

11.4 Level 2 Specifics

11.4.1 *Algorithm for Pipeline*

11.4.1.1 IDL L1 to Pre-L2 step

The PEPSSI pipeline conversion from Level 1 (L1) to Level 2 (L2) data has two steps. The first uses an IDL program to rearrange the Raw L1 data into single-rowed vector-valued FITS tables. These “Pre-L2” files are temporary and not in the final PDS archive. Multiple Pre-L2 files will be combined in the next processing step into final L2 files; see section 11.4.2.2 below.

The base routine PEPSSI_LEVEL2_PIPELINE reads from the input file the following variables:

```
Filein
dir_cal
temp_dir
status_file
fileout
```

and generates in the output files one of more of the corresponding HDUs

```
N1
N1_STATUS
N2
N2_STATUS
D_N1
D_N2
PHA_ELECTRON
PHA_LOW_ION
PHA_HIGH_ION
PHA_DIAG
STATUS
```

Decoding of the level 1 data stream follows two steps: first blocks are read into the 7 structures:

```
N1 = { $
    met:lonarr(blockcnt), $
    high_ions:lonarr(6,19,blockcnt), $
    electrons:lonarr(3,3,blockcnt), $
    low_ions:lonarr(7,16,blockcnt), $
```

```
rates:lonarr(32,blockcnt), $
housekeeping:fltarr(33,blockcnt) }
```

```
N2 = { $
met:lonarr(blockcnt), $
high_ions:lonarr(6,19,blockcnt), $
electrons:lonarr(3,3,blockcnt), $
low_ions:lonarr(7,8,blockcnt), $
rates:lonarr(24,blockcnt) }
```

```
PHA_ELECTRON={ $
met:lonarr(ele_cnt) , $
energy:fltarr(ele_cnt) , $
multi:intarr(ele_cnt) , $
chann:intarr(ele_cnt) }
```

```
PHA_LOW_ION={ $
met:lonarr(low_cnt) , $
tof:fltarr(low_cnt) , $
heavy1:intarr(low_cnt) , $
heavy0:intarr(low_cnt) , $
startseg:intarr(low_cnt) }
```

```
PHA_HIGH_ION={ $
met:lonarr(hig_cnt) , $
energy:fltarr(hig_cnt) , $
tof:fltarr(hig_cnt) , $
multi:intarr(hig_cnt) , $
heavy1:intarr(hig_cnt) , $
heavy2:intarr(hig_cnt) , $
chann:intarr(hig_cnt) , $
```

startseg:intarr(hig_cnt) }

PHA_DIAG={ \$
met:lonarr(dia_cnt) , \$
energy:fltarr(dia_cnt) , \$
tof:fltarr(dia_cnt) , \$
start:intarr(dia_cnt) , \$
stop:intarr(dia_cnt) , \$
fired:intarr(dia_cnt) , \$
multi:intarr(dia_cnt) , \$
heavy1:intarr(dia_cnt) , \$
heavy0:intarr(dia_cnt) , \$
chann:intarr(dia_cnt) , \$
startseg:intarr(dia_cnt) }

STATUS = { \$
MET:lonarr(nsta), \$
STATINT:lonarr(nsta), \$
MACBLCKS:lonarr(nsta), \$
TLMVOL:lonarr(nsta), \$
WTCHADDR:lonarr(nsta), \$
WTCHMEM:bytarr(nsta), \$
WTCHDATA:lonarr(nsta), \$
PEPSWVER:bytarr(nsta), \$
ALARMID:bytarr(nsta), \$
ALARMTYP:bytarr(nsta), \$
ALARMCNT:bytarr(nsta), \$
CMDEXEC:bytarr(nsta), \$
CMDREJCT:bytarr(nsta), \$
MACEXEC:bytarr(nsta), \$
MACREJCT:bytarr(nsta), \$

```
MACROID:bytarr(nsta), $
MACROLRN:bytarr(nsta), $
MONRESP:bytarr(nsta), $
WRITEENB:bytarr(nsta), $
HVPSCURR:fltarr(nsta), $
HVPSVOLT:fltarr(nsta), $
BIASCURR:fltarr(nsta), $
BIASVOLT:fltarr(nsta), $
PEPSTAT:lonarr(nsta), $
DVOLTP5:fltarr(nsta), $
AVOLTN5:fltarr(nsta), $
VOLTP2:fltarr(nsta), $
VOLTN5:fltarr(nsta), $
VOLTP15:fltarr(nsta), $
VOLTN15:fltarr(nsta), $
DCURRP5:fltarr(nsta), $
ACURRP5:fltarr(nsta), $
CURRP2:fltarr(nsta), $
CURRN5:fltarr(nsta), $
CURRP15:fltarr(nsta), $
CURRN15:fltarr(nsta), $
PRIMCURR:fltarr(nsta), $
LVPSTEMP:fltarr(nsta), $
ENGYTEMP:fltarr(nsta), $
HVPSTEMP:fltarr(nsta), $
ADDR12C:lonarr(nsta), $
RSLT12C:lonarr(nsta) $
}
```

where blockcnt is the number of blocks present in the level 1 file (i.e. the number of sample periods), ele_cnt is the number of electron pha events, and similarly for low_cnt, hi_cnt, and dia_cnt. nsta is the number of sample periods for the status quantities. See the full L2 file description for the meaning of the status quantities.

Example: `n1.low_ions(3,4,6)` corresponds to the number of `time_of_flight` only events (`low_ions`) coming from anode 3, 4th velocity bin, collected during the 6th time interval.

11.4.1.2 MIDL L1 to Pre-L2 step

A Java program derived from the MIDL analysis program is used to convert the Pre-L2 files into L2 files. With rare exceptions, each L2 file contains data from exactly 86,400 contiguous spacecraft seconds (about one day). So the Times-of-Day (TODs), in UTC, of the start and stop times of data coverage from successive days both will drift with respect to UTC with the clock on the spacecraft, and will jump by about one second on days that have leap-seconds. Through 2010, the typical clock drift rate through 2010 is of order 1ms/d, and the TOD of the start and stop times for each file are within a few seconds of midnight on each day.

The exceptions to the 86,400 spacecraft seconds rule are days when new Rate Box definitions are loaded to the spacecraft, in which case there will be a “before” file and an “after file” (such load-days are very rare).

The DataConverter program essentially “flattens out” the Pre-L2 structure. In the L2 files, each row is a separate sampling period or PHA event (i.e. the `blockcnt`, `hi_cnt`, `lo_cnt`, etc. axis is now the row structure of the FITS binary table). Each “Rate Box” or hardware count is a separate column in the N1 or N2 FITS table. So, for example, each row of the N1 rates extension represents a separate sampling period (usually 600 seconds) and each column is a different rate, listed in alphabetical order by rate name, so the columns would be:

ET, MET, B00S00, B00S01, ..., B18S05, C00D00, C01D01, ..., C23, C24, HK00, HK01, ..., HK34, J00, J01, ..., J06, L00S01, L00S02, ..., L15S05, L15Unknown, R00S00, ..., R02S05

The meaning of the individual Rate Labels will be discussed below, or see the comments in the corresponding FITS header. As another example, the `PHA_ELECTRON` extension is another simple 2D table of values; each row represents a separate PHA event, the columns are:

ET, MET, ApID (packet Application Process Identifier; also Application ID), Cross_Talk_Indicator, Electron_Channel, Raw_Energy

11.4.2 Dataflow Block Diagram

11.4.2.1 L1 to Pre-L2

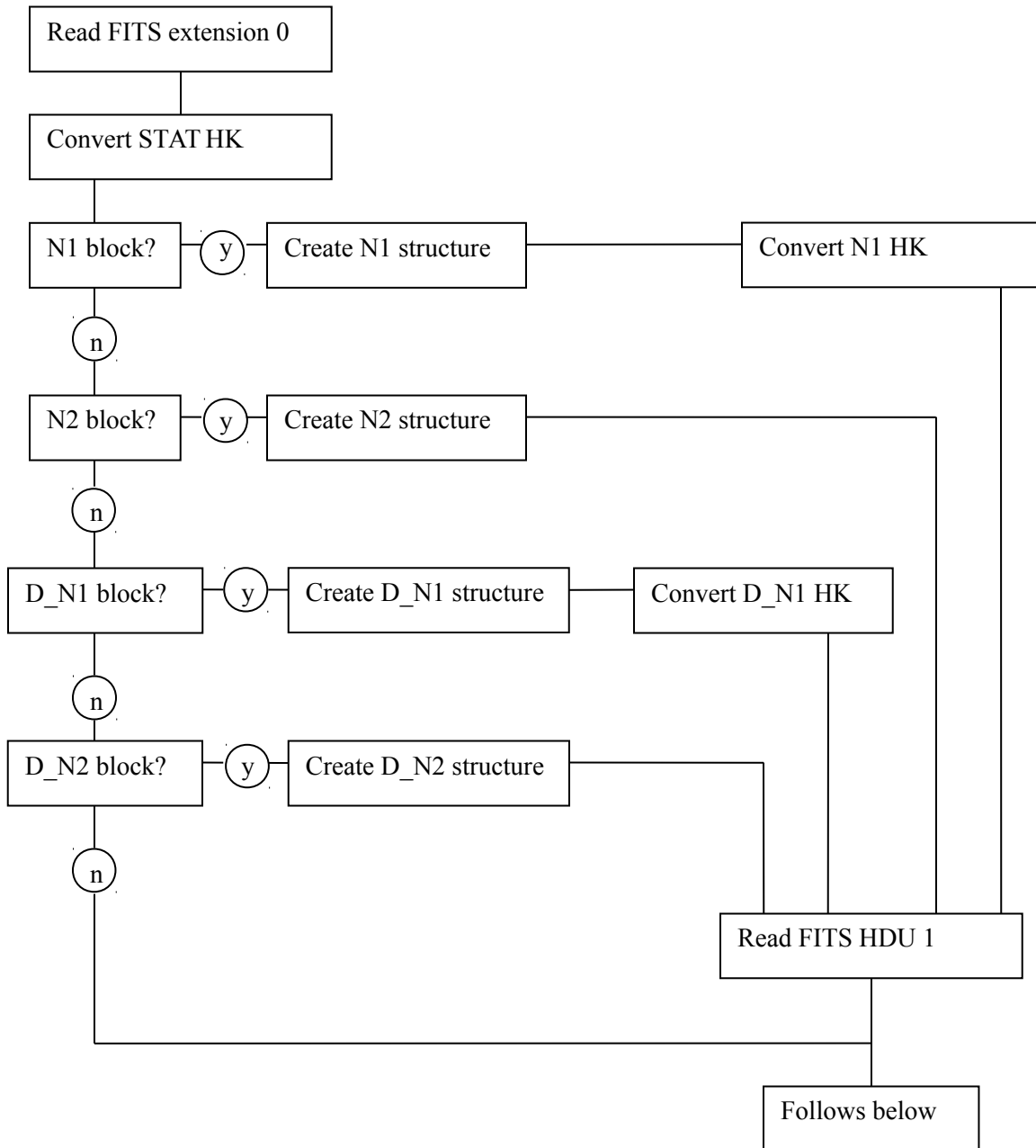

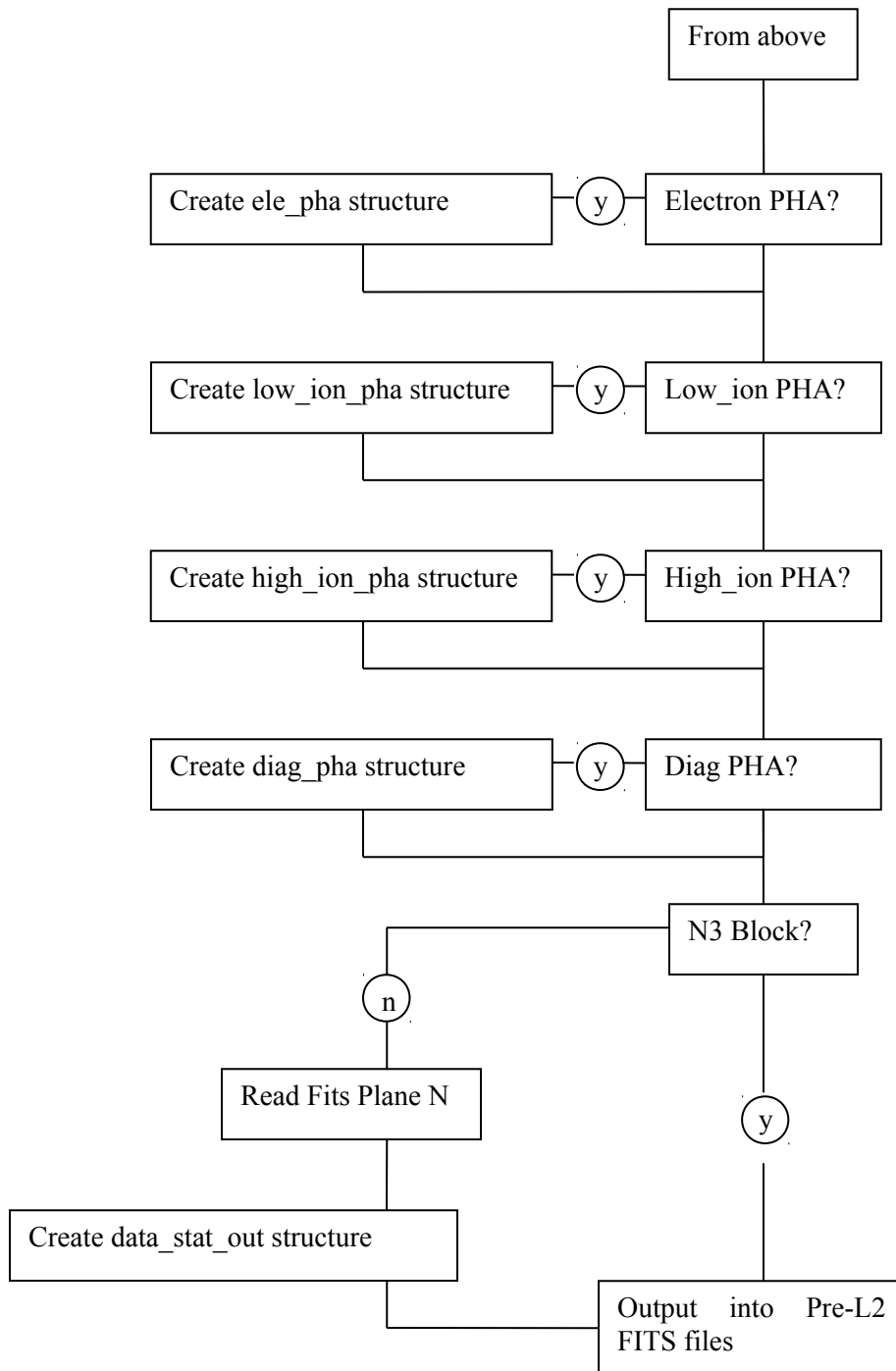

11.4.2.2 Pre-L2 to L2 processing

There is no data-flow diagram for Pre-L2 to L2 processing.

11.4.3 L2 Data Format

The contents of the L2 files are detailed in the following sections. The ordering of the extensions is *not* guaranteed, programs accessing the data should search for the desired extension by name (in the EXTNAME keyword). There will always be only one extension of each type (EXTNAME) and not all types will be present. An extension will only be present if there is data of that type taken during the time period covered by that file. The coverage of a single L2 “daily” file begins at an integer multiple of 86,400 ephemeris (TDB, Barycentric Dynamical Time) seconds from a time near a nominal midnight UTC time at launch (January, 2006). All events and rate measurements with timestamps in that file occur before the 86,400th TDB second following. All event records in the file occur *between* those two TDB times, but there are rarely if ever event records with timestamps *at* those times. The values and keyword values in the FITS header dealing with time are as follows:

ET – N.B. not in the FITS header or PDS label. The ephemeris time of the beginning of coverage of this file. This corresponds to a time near 00:00:00 (midnight) UTC at the start of the mission (January, 2006), but slides back with respect to 00:00:00 UTC as the mission progresses through UTC leapsecond events.

MET,METEND – Integer MET values approximating the beginning and ending of the coverage period of this file, expressed in terms of the spacecraft clock. Since these values are truncated to the previous integer value and do not include spacecraft clock partition information, they should be used with caution, if at all. The filename contains a truncated version of the beginning MET keyword value. Note that, because the integer MET values are rounded *down*, the beginning MET usually represents a time *not* actually contained in this file. Usually, two consecutive-in-time files have beginning MET values that differ by a multiple of 86,400; however, because the spacecraft clock runs slower (MET seconds are longer) than TDB seconds, sometimes that [difference modulo 86,400] will be 86,399s. The PDS keyword values START_TIME and STOP_TIME are millisecond-rounded UTC times based on these rounded MET values, and the PDS keyword values SPACECRAFT_CLOCK_START_COUNT and SPACECRAFT_CLOCK_STOP_COUNT are in turn based on START_TIME and STOP_TIME, and include sub-millisecond artifacts of the sequence of roundoffs.

STARTMET,STOPMET – Floating-point MET values of the first and last record (in any EXTENSION) in this file. These values may be useful for quickly answering data availability questions. STARTMET \geq MET and STOPMET $<$ METEND.

Other time related keywords in the header are artifacts from the processing pipeline and should be considered as “for instrument team use in validation only”.

The Primary HDU contains no data, only informational header keywords identifying mission info, observational start time, and information about the file creation (date, software version, etc.).

The available extensions are:

D_N1, D_N1_STATUS, D_N2, D_N2_STATUS, N1, N1_STATUS, N2, N2_STATUS, PHA_DIAG, PHA_ELECTRON, PHA_LOW_ION, PHA_HIGH_ION

The different extensions are described below. For detailed information such as the data-type of different columns see the FITS header in the data file.

Extension names beginning with “D_” (and the PHA_DIAG extension) represent data taken in diagnostic mode. Diagnostic data is taken for purposes of calibration and understanding the instrument at a very low level. Diagnostic data is complex and often taken under unusual conditions. It is unlikely that the general user will be able to use diagnostic data in any meaningful way. In diagnostic mode, a PHA event is generated whenever any of the instrument detectors sees an event. All events are counted except for those with the multi-hit flag set (by default, the multi-hit setting can be changed). This means that there are no “Low-Ion” events because, by definition, these events are required to have no SSD fire, which is mutually exclusive with the diagnostic mode requirement that every diagnostic event is initiated with an SSD fire. Many of the columns will contain “fill values” for certain types of events. The “Fill” values for invalid Energy and TOF PHA data are: Energy – 1023 and TOF – 2047. In the PHA_DIAG extension, what would normally be an electron event, for instance, will have a Time of Flight value of 2047.

11.4.3.1 PHA_HIGH_ION

When an ion enters the PEPSSI detector, if it has enough energy, we measure an Energy and a Time of Flight (TOF). Since we don’t have enough bandwidth to telemeter all of our events, we use a round robin priority scheme to decide which PHA events to discard and which to telemeter. All of the events are counted in the N1 and N2 Rate data. The Rate data can be used to remove the priority group effects (to a large extent) from the PHA data by weighting events by their respective rates. See the L3 documentation below for more on rate-weighting.

The PHA_HIGH_ION extension contains one row for each high energy ion event that was not discarded by the priority scheme. The columns are:

ET	Ephemeris Time (s past J2000 epoch) of start of accumulation interval
MET	Mission Elapsed Time
ApID	Which ApID was this event telemetered in: N1 – 0x691, N2 – 0x692, N3 – 0x693
Cross_Talk_Indicator	Did more than one detector fire?
H0	Did Heavy Ion Discriminator 0 fire?
H1	Did Heavy Ion Discriminator 1 fire?
Ion_Channel	Detector Channel (0-8)
Raw_Energy	Energy deposited (ADU)
Raw_TOF	Time of Flight (ADU)
Start_Anode	Bits 0-5 are set if that start anode fired.

Notes for PHA High Ion data:

- **IMPORTANT NOTE:** The timing of a PHA event is, in general, *not* known to 1 second precision. The “time tag” of a PHA event only represents the start time of the

accumulation interval of the Rate packet with which it was telemetered. So, in normal cruise operation, for example, “N1 PHA” event arrival times are known only to the nearest 10 minutes, N2 events to the nearest minute, and N3 events to within 2 hours. See discussion of Level 3 PHA data for more details.

- See Figure 11-5 for a diagram of the detector numbering. 9 of the 12 detectors are dedicated to Ions (the other 3 are dedicated to electrons) and are configured accordingly.
- Mission Elapsed Time starts about 19-JAN-2006-18:09:05.184.
- The H0 and H1 ion discriminators were found to be of limited usefulness.
- Events with the Cross_Talk_Indicator value set are discarded from the rate counters and are not usually used in analysis.
- The Start Anode column consists of a single byte. The individual bits 0-5 indicate whether the corresponding Start Anode (0-5) registered an event. See Figure 11-5 for start anode layout. Note that, unfortunately, the numbering of the anodes is reversed from the numbering of the incoming angle sectors.
- Energy and TOF are given in raw “Analog to Digital Units” (ADU).
- The electronics of the Start Anodes are such that, while a given event may have a known TOF, the exact Start Anode information may be uncertain or completely unknown. Thus, a valid event may show more than one Start Anode, or none.

11.4.3.2 PHA_ELECTRON

The PHA_ELECTRON data is very similar to the PHA_HIGH_ION data except that the TOF-related values aren’t present since electrons aren’t detected by that part of the instrument (i.e. they only have solid state detector (SSD)-related values:

ET	Ephemeris Time (s past J2000 epoch) of start of accumulation interval
MET	Mission Elapsed Time
ApID	Which ApID was this event telemetered in
Cross_Talk_Indicator	Did more than one detector fire?
Electron_Channel	Detector Channel (0-2)
Raw_Energy	Energy deposited solid state detector (ADU)

Notes for PHA_ELECTRON data:

- Only Sectors 0, 2, and 5 have electron detectors (0,1, and 2, respectively) associated with them.
- See PHA_HIGH_ION notes for other relevant info.

11.4.3.3 PHA_LOW_ION

The PHA_LOW_ION events are from low energy ions that register in the TOF part of the detector but do not trigger the SSDs. Hence “Low Ions” have TOF data (and associated quantities like Start Anode) but no Energy data:

ET	Ephemeris Time (s past J2000 epoch) of start of accumulation interval
----	---

MET	Mission Elapsed Time
ApID	Which ApID was this event telemetered in
H0	Did Heavy Ion Discriminator 0 fire?
H1	Did Heavy Ion Discriminator 1 fire?
Raw_TOF	Time of Flight (ADU)
Start_Anode	Bits 0-5 are set if that start anode fired.

See PHA_HIGH_ION notes for other relevant info.

11.4.3.4 PHA_DIAG

In diagnostic mode, the following columns are present:

ET	Ephemeris Time (s past J2000 epoch) of start of accumulation interval
MET	Mission Elapsed Time
ApID	Which ApID was this event telemetered in?
Cross_Talk_Indicator	Did more than one detector fire?
Fired	0 - electron event 1 - ion event
H0	Did Heavy Ion Discriminator 0 fire?
H1	Did Heavy Ion Discriminator 1 fire?
Ion_Channel	Detector Channel (0-8) or (0-2 if electron)
Raw_Energy	Energy deposited solid state detector (ADU)
Raw_TOF	Time of Flight (ADU)
Start	Did a start anode fire?
Start_Anode	Bits 0-5 are set if that start anode fired.
Stop	Did the stop anode fire?

Notes for Diagnostic PHA Data:

- The “Fired” flag indicates whether the event is an Ion or an Electron event. This determines which Rate counter gets incremented as well.
- Raw Energy frequently has the 1023 fill value in diagnostic mode.
- Raw TOF frequently has the 2047 fill value in diagnostic mode.

11.4.3.5 N1 and D_N1

The N1 and N2 (and D_N1 and D_N2) extensions contain several types of “Rate” data. The Rate data is accumulated in histograms which are then dumped at set intervals. During cruise: for N1 data, usually the histograms are accumulated for 600 seconds. For N2 data, the accumulation time is usually 60 seconds except for the first hour of the day when it is 15 seconds. These values will be different during the Pluto encounter or certain testing events. The DT column will indicate the accumulation time for a given row or Rate data. The DT column may not be accurate during BTIs.

B Rates: The number of high energy ion events in the various Hi-Ion “Rate Boxes”.

C Rates: The contents of various hardware counters

HK Rates: Various housekeeping quantities such as power levels and discriminator thresholds

J Rates: Software counters that represent overall quantities like total number of Electron Events.

L Rates: The number of low energy (TOF-only) ion events in the various Lo-Ion Boxes.

R Rates: The number of electron events in the various electron “Rate Boxes”.

The N1 and D_N1 data are identical in format; the D_N1 data is taken when the instrument is in diagnostic mode. The definitions of some of the Rate Boxes are different in diagnostic mode and normal mode (i.e. the Rate Box number is the same, but its definition is different depending on the mode). The events being counted are triggered with different rules, as well, see the discussion of PHA_DIAG data for more detail.

We describe some of the rates in more detail below. A detailed description of each rate is also available in the FITS header as a comment to the keyword defining a Rate column. Example:

```
TTYPE12 = 'B01S03 ' / B01S03: Protons (60-94) Energy ADUs Sector: 3
```

means that column 12 contains rate B01S03 which is nominally Protons with energy between 60 and 94 ADUs incident from Sector 3.

B Rates: The TOF vs Energy plane is divided into 19 “Rate Boxes” as shown in Figure 11-6. Each high energy ion is classified into a Rate Box and further its incident sector is used to classify it, resulting in a Rate, or histogram cell designation of the form BnnSnn. The B boxes in normal mode for the Jupiter encounter were:

Rate Box	Species	Low Energy (ADU)	High Energy (ADU)
B00	Ions (Low TOF)	0	1023
B01	Protons	60	94
B02	Protons	95	169
B03	Protons	170	299
B04	Protons	300	534
B05	Protons	535	1023
B06	Helium	60	139
B07	Helium	140	364
B08	Helium	365	1023
B09	Oxygen	60	74
B10	Oxygen	75	110
B11	Oxygen	111	227
B12	Oxygen	228	463

New Horizons SOC to Instrument Pipeline ICD

B13	Sulfur	228	463
B14	Heavy Ions	228	463
B15	Oxygen	464	1023
B16	Sulfur	464	1023
B17	Heavy Ions	464	1023
B18	Ions (High TOF)	60	1023

In diagnostic mode, the boxes were:

Rate Box	Species	Low Energy (ADU)	High Energy (ADU)
B00	Ions (Low TOF)	0	1023
B01	Protons	55	94
B02	Protons	95	170
B03	Protons	171	299
B04	Protons	300	534
B05	Protons	535	1023
B06	Helium	55	138
B07	Helium	139	363
B08	Helium	364	1023
B09	Heavy Ions	55	138
B10	Heavy Ions	139	363
B11	Heavy Ions	364	1023
B12	Ions (No TOF)	55	86
B13	Ions (No TOF)	87	137
B14	Ions (No TOF)	139	227
B15	Ions (No TOF)	228	363
B16	Ions (No TOF)	364	585
B17	Ions (No TOF)	588	1023
B18	Ions (High TOF)	0	1023

C Rates:

C00D00	Detector 00 Singles
C01D01	Detector 01 Singles
C02D02	Detector 02 Singles
C03D03	Detector 03 Singles
C04D04	Detector 04 Singles
C05D05	Detector 05 Singles
C06D06	Detector 06 Singles
C07D07	Detector 07 Singles
C08D08	Detector 08 Singles
C09D09	Detector 09 Singles
C10D10	Detector 10 Singles
C11D11	Detector 11 Singles
C12S05	Anode 00 Singles Sector: 5
C13S04	Anode 01 Singles Sector: 4

New Horizons SOC to Instrument Pipeline ICD

C14S03	Anode 02 Singles	Sector: 3
C15S02	Anode 03 Singles	Sector: 2
C16S01	Anode 04 Singles	Sector: 1
C17S00	Anode 05 Singles	Sector: 0
C18	Electron Events	
C19	Ion Events	
C20	H0 Singles	
C21	H1 Singles	
C22	Starts	
C23	Stops	
C24	Valid TOFs	

Notes:

-“Singles” means single events on the named detector.

HK Rates:

These are various housekeeping values:

HK00	Peak Discriminator Level 0
HK01	Peak Discriminator Level 1
HK02	Peak Discriminator Level 2
HK03	Peak Discriminator Level 3
HK04	Peak Discriminator Level 4
HK05	Peak Discriminator Level 5
HK06	Peak Discriminator Level 6
HK07	Peak Discriminator Level 7
HK08	Peak Discriminator Level 8
HK09	Peak Discriminator Level 9
HK10	Peak Discriminator Level 10
HK11	Peak Discriminator Level 11
HK12	HVPS Level
HK13	BIAS Level
HK14	Start Constant Fraction Discriminator Power
HK15	Stop Constant Fraction Discriminator Power
HK16	Threshold Start Constant Fraction Discriminator
HK17	Threshold
HK18	Start Anode 0
HK19	Start Anode 1
HK20	Start Anode 2
HK21	Start Anode 3
HK22	Start Anode 4

New Horizons SOC to Instrument Pipeline ICD

HK23	Start Anode 5
HK24	Heavy Discriminator 0
HK25	Heavy Discriminator 1
HK26	Command word A mirror
HK27	Command word B mirror
HK28	Event parameter A mirror
HK29	Event parameter B mirror
HK30	Event parameter C mirror
HK31	Bus read address (from most recent bus read)
HK32	Bus read value (resulting data value)
HK33	Unknown0
HK34	Unknown1

Notes:

- HK33 and HK34 are only retained because they're present in the telemetry. They're just spare values.

J Rates:

These are software counter totals:

J00	Electron Events
J01	Hi-E Ion Events
J02	Low-E Ion Events
J03	Electron Discards
J04	Hi-E Ion Discards
J05	Diagnostic Events
J06	Diagnostic Discards

L Rates:

Rate Box	Type	Lower TOF (ADU)	Upper TOF (ADU)
L00	Unused	0	0
L01	Light Very Fast	6	13
L02	Light Fast	14	31
L03	Light Slow	32	75
L04	Light Very Slow	76	179
L05	Unused	0	0
L06	Medium Very Fast	45	79
L07	Medium Fast	80	141
L08	Medium Slow	142	252
L09	Medium Very Slow	253	449
L10	Unused	0	0
L11	Heavy Very Fast	90	159
L12	Heavy Fast	160	283
L13	Heavy Slow	284	505

L14	Heavy Very Slow	506	899
L15	Dump Bin	0	1024

Notes:

- Since the heavy ion discriminators appear to be of limited usefulness, the L Rate Boxes were reprogrammed after the Jupiter observing phase and are substantially different for the next observing phase of the mission.
- Light events – neither heavy ion discriminator fired.
- Medium events – H0 fired, H1 didn't
- Heavy events – both discriminators fired.

R Rates:

R rates represent electron events.

Rate Box	Lower Energy (ADU)	Upper Energy(ADU)
R00	0,720	57,1023
R01	57	202
R02	203	719

Notes:

- R00 nominally includes both low and high energies, but this is only a complication early in the Jupiter phase (days 6 – 22 of 2007), after which the electron detector threshold was raised so that only the high energies received valid events. This is why the L3 spectrograms put the electron pixels in the order: R01, R02, R00
- There are only 3 (out of 12) detectors dedicated to electrons (see Figure 11-5). We number sectors the same way we do in the other rates, so electron rates only come from sectors: S00, S02, and S05..
- For a discussion of designations R00A, R00B and SALL in L3 PHA data, see section 11.4.5.4.

11.4.3.5.1 Rate Box Definitions

For Electrons and Low-Ions, the rate box definitions are simple ranges in Energy and TOF in ADUs which can be found in the Level 2 headers. For Hi-Ions, the Rate Boxes are regions in the TOF-Energy plane (see Figure 11-6). The precise specification of the rate boxes is complex and this is why we include rate box classifications in the Level 2 PHA data. However, we also provide the file RATEBOXDEFINITIONPLANES.FIT in the CALIB/ directory of PDS data sets.

Through the Jupiter mission phase and into the Pluto Cruise mission phase, PEPSSI has had three sets of Rate Box definitions. There are separate rate box definitions for Normal and Diagnostic mode. The

RateBoxDefinitionPlanes.fit file contains 6 extensions (3 sets x 2 modes). The Rate Box classification data is presented as an image containing the Rate Box id number (0-18) in the Time of Flight (TOF) vs Energy plane. TOF and Energy are presented in raw analog to digital units (ADUs). Thus, TOF ranges from 0-2047 and Energy from 0-1023. The Rate Box classification of any event can be determined by looking up the corresponding pixel in the classification image. In diagnostic mode, Energy-only detections have a fill value of 2047 for TOF, and the Rate Box classification image assumes that. The time range for each set is given in the header of the respective HDU. The ranges are:

Set 0	Before 2006-07-07
Set 1	2007-07-07 through 2007-05-24
Set 2	After 2007-05-24

11.4.3.6 N2 and D_N2

N2 (and D_N2) are identical to their N1 counterparts except that they are typically sampled much more frequently (every 15 or 60 seconds) and only some of the L and C rates are present:

- Only L01,02,03,04,08,09,13,14 are present
- Only C00,02,03,05,06,07,08,09,10,13,14,15,16,17,22,23,24 are present

11.4.3.7 (D)_N(1/2)_STATUS

All the STATUS extensions contain the same quantities for their respective coverage periods.

STAT00	STATINT	Status interval (seconds)
STAT01	MACBLCKS	Number of macro blocks fre
STAT02	TLMVOL	Telemetry volume produced
STAT03	WTCHADDR	Memory watch address
STAT04	WTCHMEM	Watched memory (pg. no)
STAT05	WTCHDATA	Watched memory
STAT06	PEPSWVER	Software version number
STAT07	ALARMID	Latest Alarm Id
STAT08	ALARMTYP	Latest alarm type
STAT09	ALARMCNT	Count of alarms
STAT10	CMDEXEC	Commands executed
STAT11	CMDREJCT	Commands rejected
STAT12	MACEXEC	Macro commands executed
STAT13	MACREJCT	Macro commands rejected
STAT14	MACROID	Id of most recent macro executed
STAT15	MACROLRN	Macro learn mode
STAT16	MONRESP	Monitor response
STAT17	WRITEENB	Memory write enable
STAT18	HVPSCURR	HVPS current

STAT19	HVPSVOLT	HVPS voltage
STAT20	BIASCURR	Bias current
STAT21	BIASVOLT	Bias voltage
STAT22	PEPSTAT	PEPSSI status word
STAT23	DVOLT5	+5V digital voltage
STAT24	AVOLTN5	+5V analog voltage
STAT25	VOLTP2	+2.5V voltage
STAT26	VOLTN5	-5V voltage
STAT27	VOLTP15	+15V voltage
STAT28	VOLTN15	-15V voltage
STAT29	DCURRP5	+5V digital current
STAT30	ACURRP5	+5V analog current
STAT31	CURRP2	+2.5 volt current
STAT32	CURRN5	-5V current
STAT33	CURRP15	+15V current
STAT34	CURRN15	-15V current
STAT35	PRIMCURR	Primary current
STAT36	LVPSTEMP	LVPS temperature
STAT37	ENGYTEMP	Energy temperature
STAT38	HVPSTEMP	HVPS temperature
STAT39	ADDR12C	I2C read command address
STAT40	RSLT12C	I2C read command result

11.4.4 *Bad Time Intervals (BTIs)*

Various instrument conditions can make the PEPSSI data difficult or impossible to use for scientific purposes. Powering down, ramping the high voltage power up or down, running in diagnostic mode, etc. will all make the PEPSSI data unusable for standard analysis. The “PEPSSI_BTI.txt” file, when present, contains a tab-separated list of “Bad Time Intervals” (BTIs), which should be used to exclude data that are unsuitable for science analysis. It should be noted that the entire “Launch” phase of PEPSSI data is classified as a BTI.

While not actually a BTI, the period between 2007 day 144 and day 178 should be treated with caution as well. The PEPSSI Rate Box tables were changed on day 144 and calibration and analysis of this period is still preliminary.

11.4.5 *L3 Data Format*

The L3 Files contain calibrated scientific data in an easily accessible form. There are three basic types of data in the L3 files: Quick-Look, flux-calibrated Rate Data, and calibrated PHA data. As with the L2 files, each file contains one UTC day’s worth of data. No Diagnostic mode data is present in the L3 files. No “multi-hit” data is present in L3 files. Only N2-telemetered PHA data is present in L3 files.

The Level 3 files are meant to be, as much as possible, self-documenting. All calibration constants, calibration formulas, and physical units should be present in the FITS header in an easily readable format. It should be possible, albeit with a lot of work, to reproduce the Level 3 files independently from the Level 2 files using the information in the Level 3 headers.

11.4.5.1 Primary HDU: Rate Weighted 2-D Histogram

The image in the primary array of the L3 file is a rate-weighted 2-D histogram of the PHA data for that day binned in calibrated deposited energy. It represents a “best available” overview of the day’s most detailed high energy ion data.

The priority scheme distorts ion abundances, so we correct for that by using a “rate-weight” rather than a single count. For each period of 600 seconds, we divide the counts reported in the N2 rate box by the number of PHA events observed in that rate box. This is the weight those events are then assigned in constructing the histogram (see Figure 11-7 and Figure 11-8 for comparison of weighted and unweighted histograms). The two axes: energy deposited in the SSD and time of flight, are simple linear calibrations of the measured values. The calibration parameters are reported in the primary FITS header.

11.4.5.2 Quick Look Spectrograms

The extensions: SPEC_Protons, SPEC_Helium, SPEC_Heavies, SPEC_Electrons, and SPEC_LowIon, contain quick-look spectrograms of their respective species. These spectrograms present counts/second N2 data, averaged over 60 second intervals and summed over all incidence directions (i.e. “Sectors”). During cruise, 60 seconds is, except for the first hour of the day, the default accumulation interval of N2 data (Before 2007 day 42, the default N2 accumulation interval was 30 seconds). The x-axis of the spectrograms is hour of day. On the y-axis each pixel represents a different rate (e.g. B00, L01, R02, etc.). Nominal deposited energies of the rate boxes (or, in the case of Low-Ions, nominal time of flight bins) are given in the FITS header.

11.4.5.3 FLUX

This HDU contains calibrated fluxes, uncertainties, and raw counts/sec rates for all of the High Energy Ion and Electron N2 Rate data. There is also an accumulation time column (**DT**) and three timing columns.

IMPORTANT NOTE: The UTC **YEAR** and **DAY_OF_YEAR** columns are only included for convenience in plotting. DO NOT USE THEM for precise timing as there could be leap-second ambiguities in them. Use the ephemeris time (**ET**) column if precision is important.

For some Rate Boxes, the exact particle species is undeterminable. They contain both Oxygen and Sulfur. Separate calibrations are supplied for Oxygen and for Sulfur. The Rate Box name is modified by appending an “O” or an “S” respectively in the FITS table column name.

All of the quantities used in the calibration of the flux measurement, including their uncertainties are included in keywords in the FITS header. A description of the calibration procedure follows.

IMPORTANT NOTE: Calibration work on the PEPSSI instrument is ongoing. Uncertainties in some quantities (particularly efficiency) are still very large.

11.4.5.3.1 FLUX Calibration Procedure

We calculate the differential intensity j (1/cm²sr-s-keV) in terms of the counts C , time coverage T (s), geometric factor G (cm²sr), upper and lower energy bounds E_{hi} and E_{lo} (keV), and detection efficiency η :

$$j = \frac{C/T}{G\Delta E\eta},$$

where $\Delta E \equiv E_{hi} - E_{lo}$. We assume Poisson statistics for C , no error in T , absolute errors in G , E_{hi} , E_{lo} and relative error in η . So, formally we quote the counts as $C = C \pm \sqrt{C}$, the energies as $E = E \pm \delta E$, and the geometry factor is $G = G \pm \delta G$. We could also write $\eta' = \eta' \pm \delta\eta'$ but choose instead to define the relative error $\mathcal{E} \equiv \frac{\delta\eta}{\eta}$. Starting with the minimum and maximum efficiencies that describe a two sigma confidence band, η_{lo} and η_{hi} , we determine our best efficiency using the geometric mean $\eta = \sqrt{\eta_{hi}\eta_{lo}}$ and subsequently determine the relative error $\mathcal{E} = \sqrt{\frac{\eta_{hi}}{\eta_{lo}}}$. So, we can quote the efficiency and relative error as $\eta = \eta \times \frac{\delta\eta}{\eta}$, or $\eta = \eta \times \mathcal{E}$, meaning that the actual efficiency is between η/\mathcal{E} and $\eta\mathcal{E}$, to one sigma confidence.

With these given errors the formal error in j is given by:

$$\delta j = j \sqrt{\frac{1}{C} + \left(\frac{\delta G}{G}\right)^2 + \frac{(\delta E_{hi})^2 + (\delta E_{lo})^2}{\Delta E^2} + \left(\frac{\delta\eta}{\eta}\right)^2} = j \sqrt{\frac{1}{C} + \left(\frac{\delta G}{G}\right)^2 + \frac{(\delta E_{hi})^2 + (\delta E_{lo})^2}{\Delta E^2} + \mathcal{E}^2}$$

Here we have assumed that all errors $\delta x_1, \dots, \delta x_N$, are uncorrelated and have used the general expression for the error in a function $f = f(x_1, \dots, x_N)$:

$$(\delta f)^2 = \sum_{i=1}^N \left(\frac{\partial f}{\partial x_i} \delta x_i \right)^2$$

A “pseudo-code” version of the actual calculation code used is given in **COMMENT** keywords in the FITS header.

Note on the correlation of the errors in E_{lo} and E_{hi} :

To zeroth order, we can treat the errors on E_{lo} and E_{hi} as uncorrelated. One pragmatic reason is that it is a conservative assumption; if we are wrong then we are *overstating* the errors (at most by a factor of $\sqrt{2}$). Also, there are times when the uncertainty in E_{lo} or E_{hi} will be quite uncorrelated. For example the E_{lo} could depend on our understanding of the SSD threshold, while the E_{hi} could depend on our estimate of how fast the spectrum will be falling, both very different things. The most problematic case (from an error propagation point of view) would be where we believe we know the passband width ΔE very well but we are not sure of the absolute energies. We think most of these potential cases are taken care of in the channel-to- $E_{deposit}$ calibration (which establishes the scale) whereas most of the potential cases of uncorrelated errors in E_{lo} and E_{hi} occur in the $E_{deposit}$ -to- $E_{incident}$ calibration.

11.4.5.3.2 Derivation and Explanation of Calibration Table Values

In the headers of the L3 files, we have supplied values to convert the instrument specific data (e.g., count rates) into physical instrument-independent units (e.g., differential intensity), as well as computing the physical quantities themselves. It must be stressed that these are preliminary values and calibration work by the instrument team is ongoing.

The calibration quantities are energy pass-band ($\Delta E \equiv E_{hi} - E_{lo}$, lower and upper limit of the energies of the particles measured), measurement efficiency (η , the fraction of valid incident particles that are actually measured), the geometry factor (G , the measurement of the physical detector size and solid angle subtended by the field of view). These values are all given and applied with uncertainties in the Level 3 files.

The energies are incident energies. Incident energy is the energy the particle has just before entering the instrument aperture absent the effect of the ~ 3 kV accelerating potential, which would induce a charge dependent energization. These energies were determined using a Monte Carlo technique that includes the energy loss as the particles trace through the entire system: start foil, free time-of-flight area, stop foil, dead layer, and energy defect. Losses through the foils are simulated and traced, as well as trajectory aberrations due to angular scattering. The energy defect for every particle and energy is also estimated by the SRIM code and checked with real data, where available. Some ground calibration of protons was also included. The uncertainties were not quantitatively determined from this modeling and measurements but are rather estimated from the known differences between various techniques. The geometry factors are derived from the same technique with similarly non-quantitative errors. These calibration values, although the uncertainties have not been estimated quantitatively, we consider appropriate to use for scientific study.

The largest uncertainty in the calculated PEPSSI fluxes in the Level 3 data is due to the efficiency determination. PEPSSI, like most particle instruments (excluding sensors that rely only on solid state detectors and measure relative high $\sim > 1$ MeV/nuc particles), is far from 100% efficient. This is due in large part to the “foil efficiency,” which is the fraction of incident ions that result in secondary electrons that are detected by the micro channel plate (MCP). This efficiency is dependent on the voltage established across the MCP. So there are at least two primary physical processes involved (a) the probability that there are any secondary electrons emitted from the foil and (b) the probability that any resulting electrons are steered towards the MCP and multiplied to a sufficient current conducted to the anodes and that this signal triggers the start or stop discriminators.

We can determine this through a combination of ground measurements, through analysis of the in-flight calibration alpha-particle source, modeling, and through intercalibration with known measurements. Before we can confidently report absolute fluxes, we must do all of these things. Currently we have only employed the final method, which has the obvious drawback of not providing an independent determination of the absolute flux. Therefore the fluxes provided in the Level 3 data should not be used as is to conduct science that is relying on absolute fluxes for scientific interpretation unless the user determines the fluxes independently and with full knowledge of the care that must be taken.

In addition to these issues, a further consideration must be taken into consideration. The PEPSSI instrument was specifically engineered to make low rate measurements. This means that whenever there was a trade off between engineering effort, electronic components, power usage, mass, and volume, and ability to make high rate measurements, the later was given relatively low priority. For example, the CPU

was selected for its low power consumption, which means that there is an upper limit to the total number of events that can be processed. Therefore the user has to be aware that saturation of the rates can take place and that the saturation does not have to be uniform across different rates. It is possible during high rate periods for a large number of triple coincidence ions, for example, to impeded the processing of electrons.

It is for this reason that it is very difficult to provide a single set of calibration values for this phase of the mission. We have provided what we have now and intend to continue to improve our knowledge and deliver the improved calibration information with subsequent updates to the PDS archive

11.4.5.4 PHA Data

The three PHA extensions: PHA_ELECTRON, PHA_LOW_ION, and PHA_HIGH_ION contain the PHA event data. As in the L2 data, each row represents a single PHA event. Events with the multi-hit (cross talk) flag set have been excluded. Quantities of limited usefulness (such as Heavy Ion Discriminator triggers) have been excluded. Because of the difficulty of removing priority scheme biases from non-N2 PHA data, only N2 (ApID == 0x692) PHA data is present in the L3 files.

Calibrated Deposited Energy and/or Time of Flight values are given. The linear calibration constants and formulas are in the FITS headers. A **Speed** column is calculated from the Time of Flight assuming a 6.0cm flight path.

The Rate Box classification for each event is given in the **Rate_Box** column. Special cases follow:

- **R00A and R00B:** R00 was originally the "dump bin" channel for electrons. Early in the mission it had a low-energy and a high energy band ("A" and "B" respectively). Since we raised the threshold, there is now only the high energy band in practice, that is, we will never see electrons in the R00A band. "R00A" and "R00B" are used in the L3 PHA data column ("Rate_Box") that indicates how the flight software categorized the event. The actual channel in N1 or N2 (L2) or FLUX (L3) extensions only exists as "R00".
- **SAll:** SAll means all Sectors (0-5) averaged together.

The PHA_HIGH_ION extension contains additional columns:

The **H_Incident_Energy**, **He_Incident_Energy**, **O_Incident_Energy**, and **S_Incident_Energy** columns contain the calculated Incident energy assuming that the event is of that (H, He, O, or S) species.

The Rate_Normalized_Weight column has removed Priority Group artifacts from the PHA data by the procedure described in the Primary HDU section above. This column is usually used in making histograms of the High Energy Ion PHA data.

11.4.6 Memory Required

1 GB memory and a 3 GHz Pentium is sufficient for processing.

11.4.7 Temporary File System Space Needed

The Pre-Level 2 files require up to 50MB per day's worth of data.

11.4.8 Predicted Size of Output File(s)

Level 2 files are in the range 1MB – 30MB. Level 3 files are typically 5-6 times larger than the corresponding Level 2 file, but only range up to a maximum of around 50MB.

11.4.9 Predicted Execution time

Less than a minute per file, typically. The L1 to Pre-L2 conversion takes a few seconds per file. The entire Jupiter phase takes 40 minutes to convert from Pre-L2 to L2 and L3 files on a Red Hat Linux machine with 4 4GHz Xeon processors. It's not known how much parallelization was actually responsible for the speed.

11.4.10 Contact/Support Person(s)

Stefano Livi, Matthew Hill, Martha Kusterer, Larry Brown and Reid Gurnee

11.4.11 Maintenance Schedule (Code/Data Updates, Documentation)

As calibration data is collected during flight, the level 2 pipeline code will require updates either to calibration files or to code for bug fixes or enhancements.

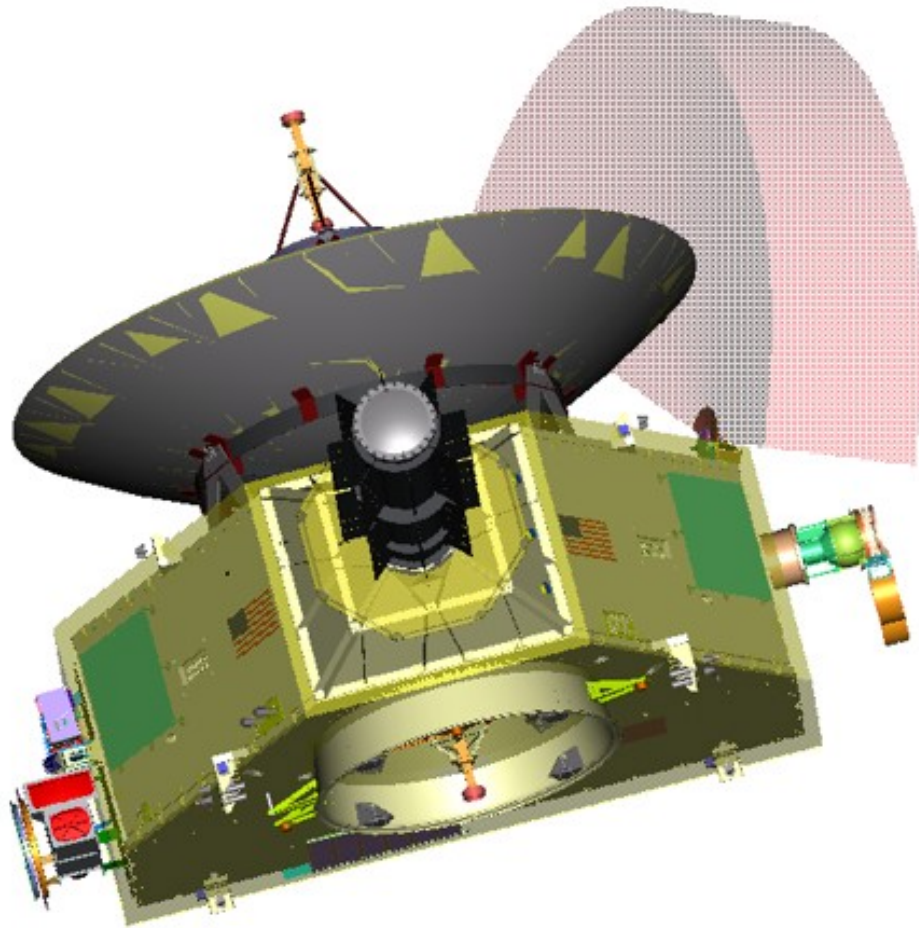

Figure 11-1: Location of PEPSSI on the New Horizons spacecraft. The lightly shaded area denotes PEPSSI Field-of-View (FOV)

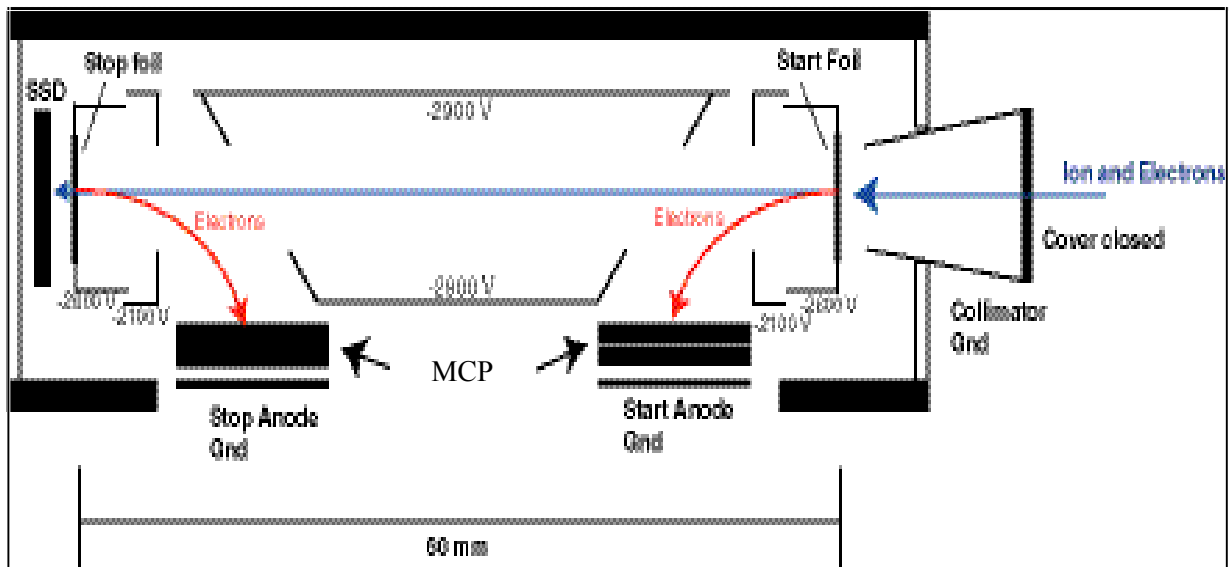
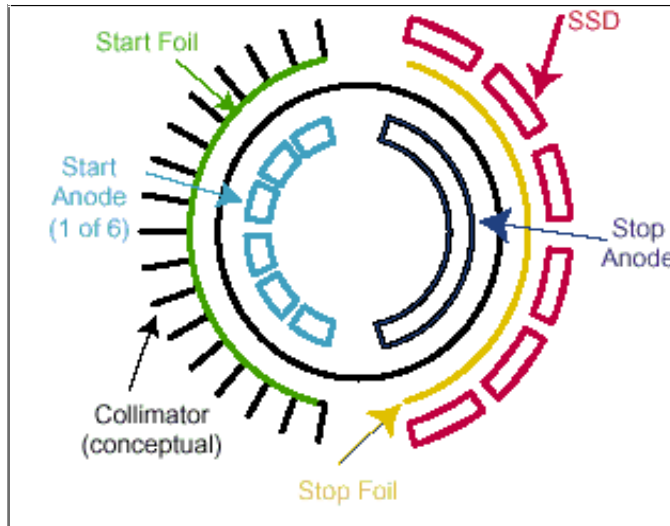

Figure 11-2: Schematic drawings of the PEPSSI sensor

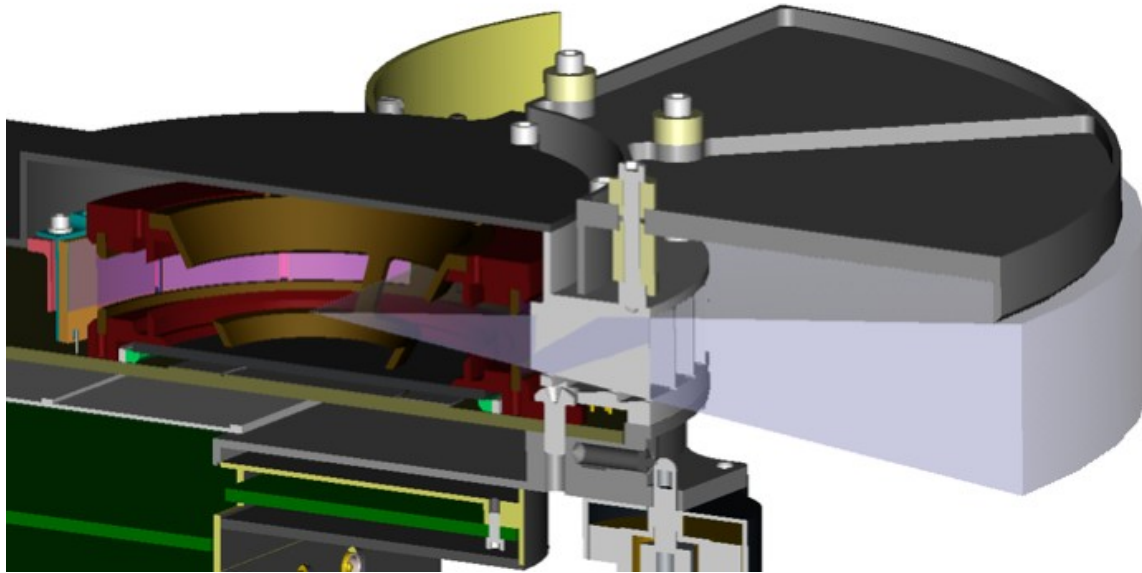

Figure 11-3: A cut-away view of the PEPSSI FOV.

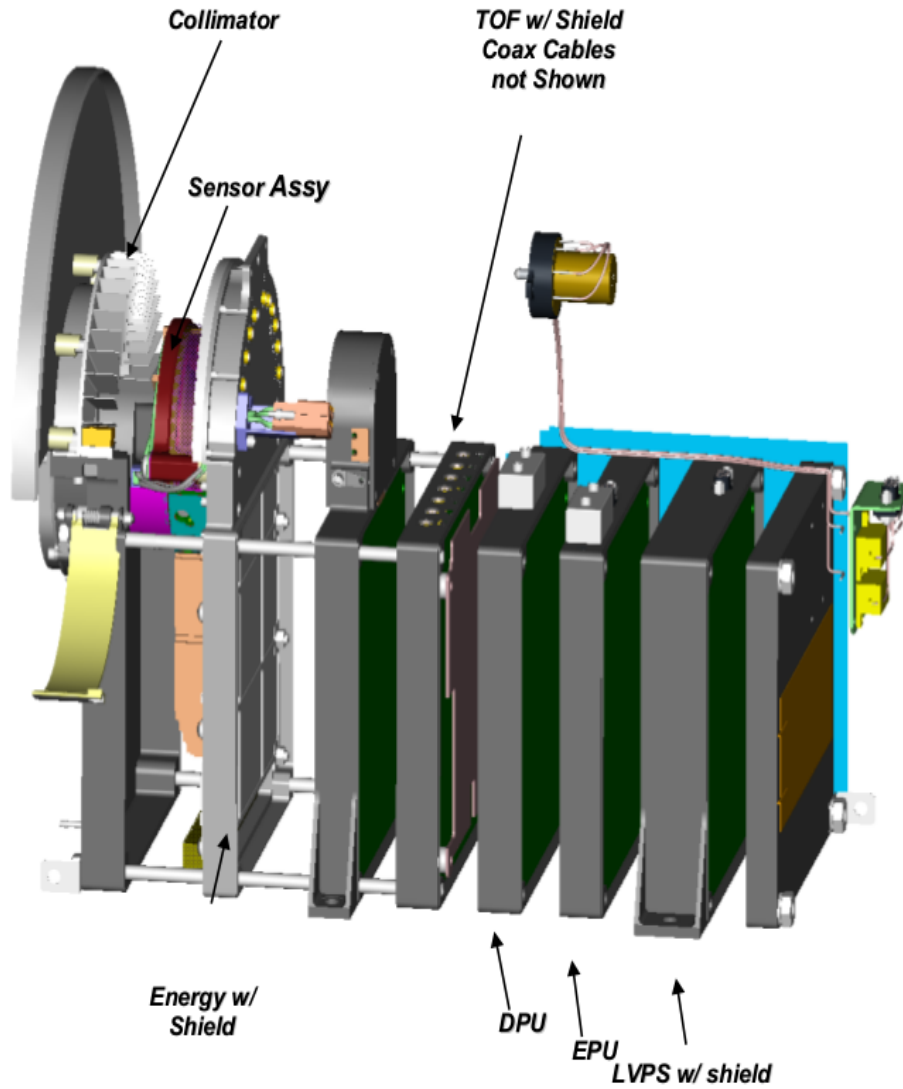

Figure 11-4: Expanded view of the PEPSSI sensor.

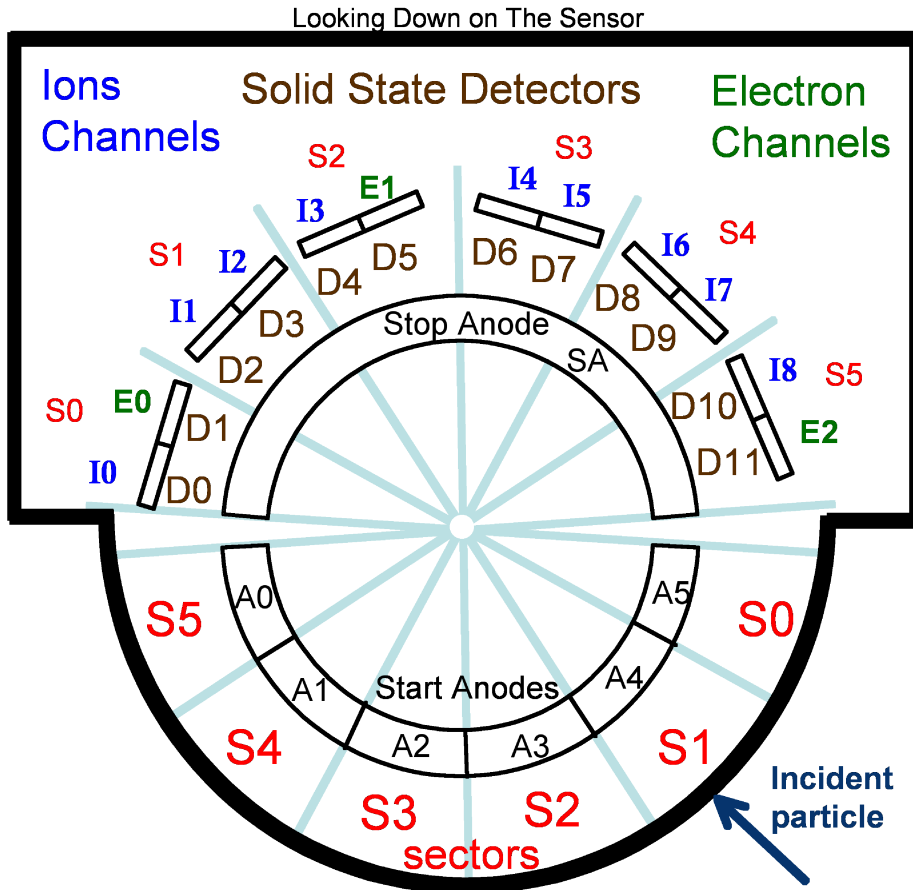

Figure 11-5: PEPSSI Layout labeling

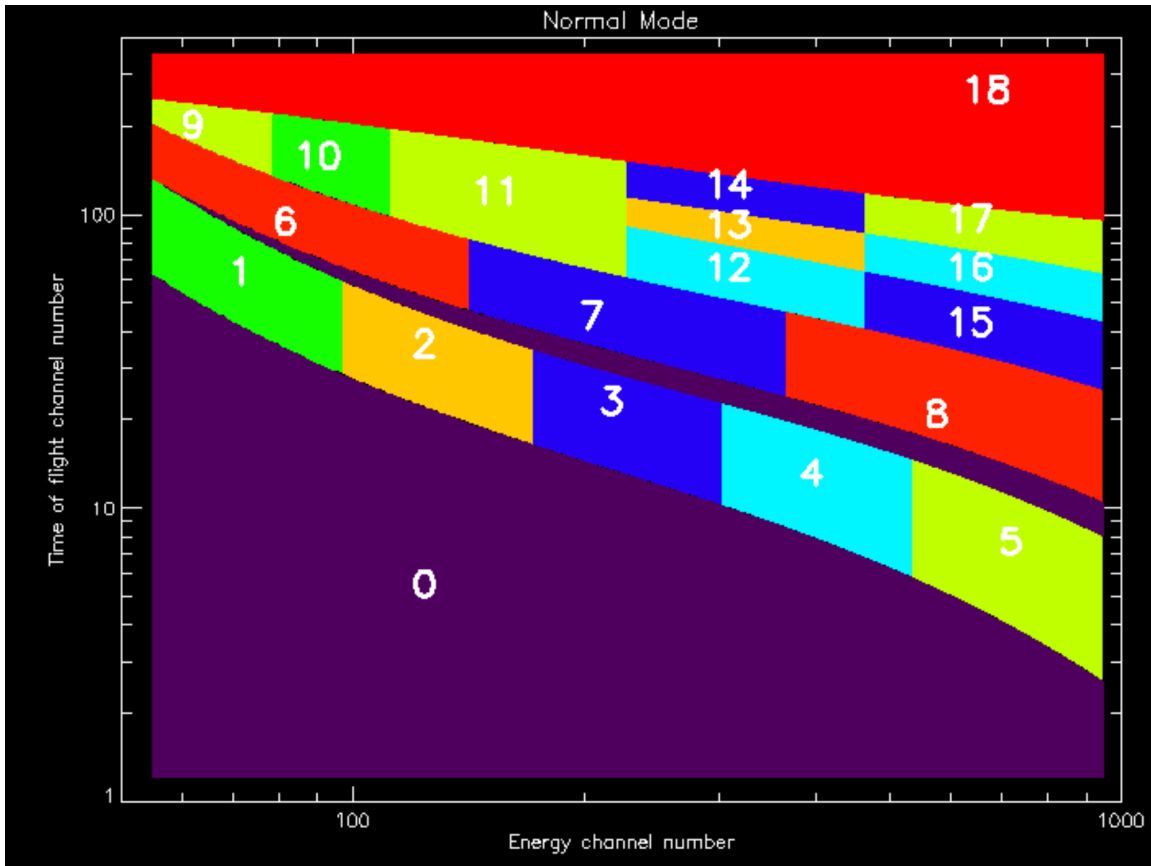

Figure 11-6: PEPSSI Rate Boxes on the TOF vs Energy Plane. Normal Mode.

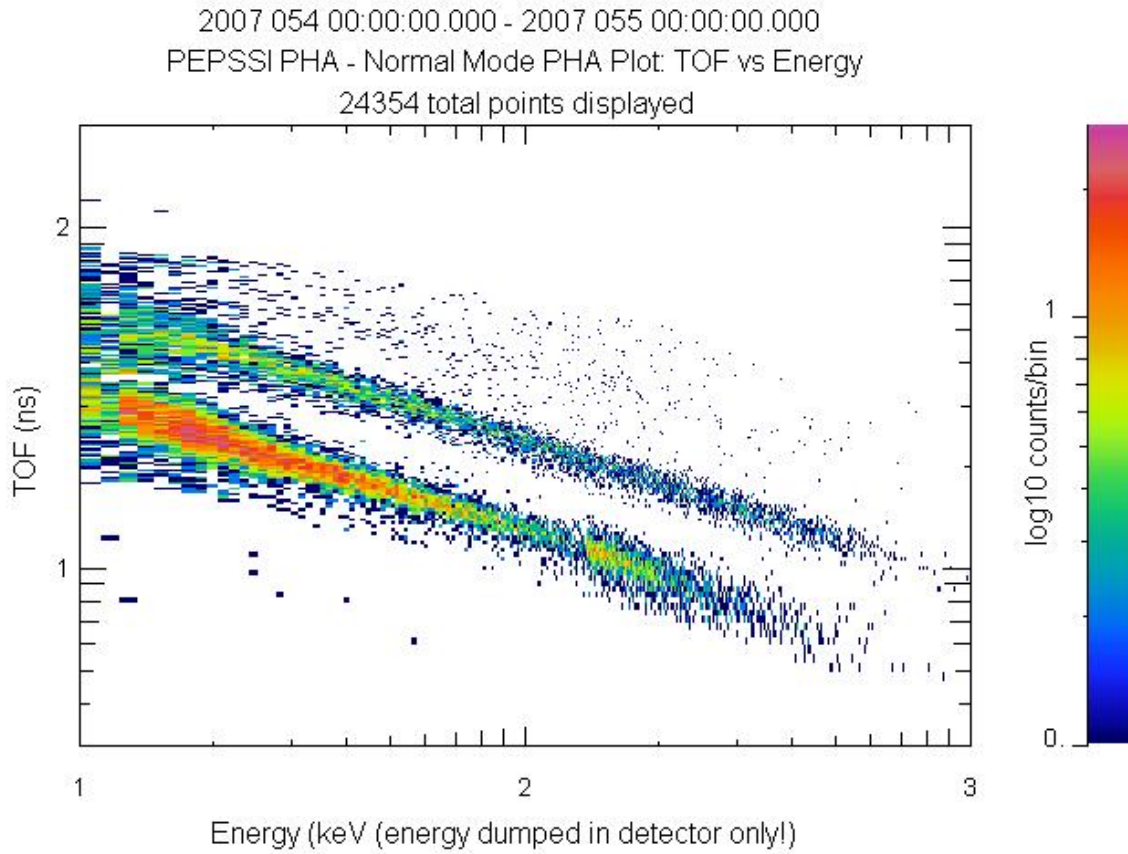

Figure 11-7: 2D PHA Histogram: No weighting. Note artifact in high energy protons (Box B03).

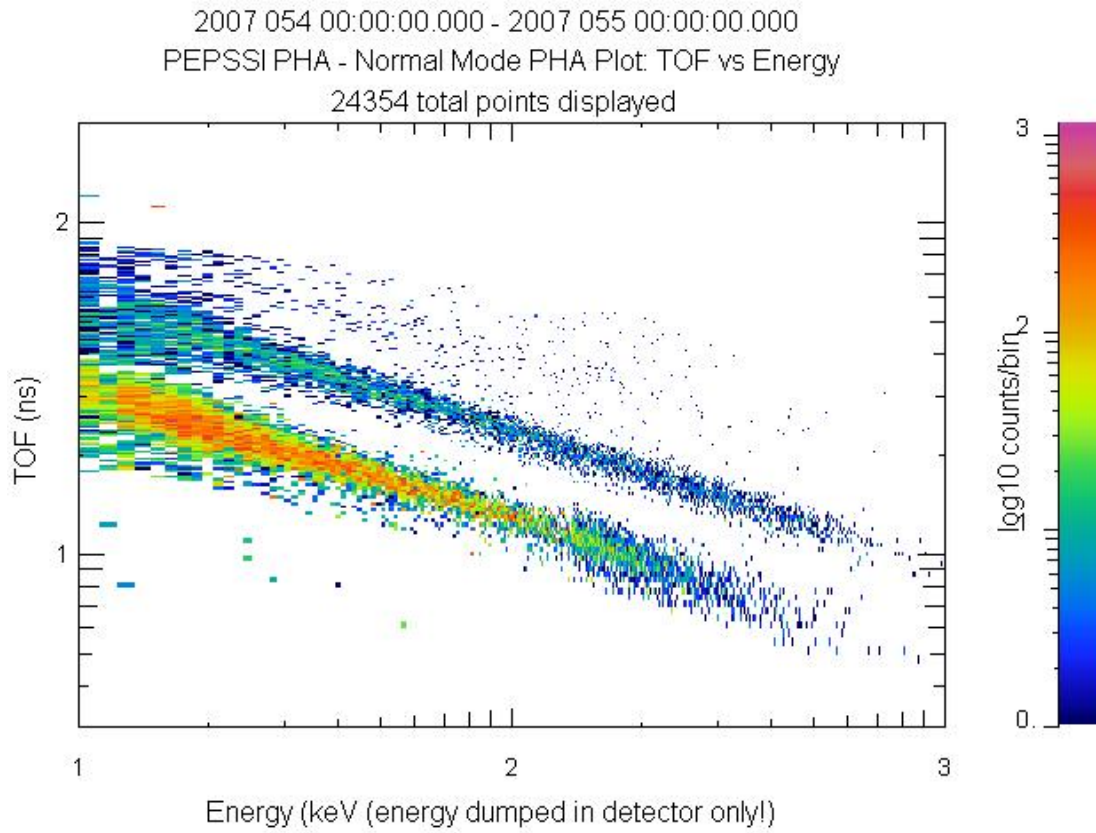

Figure 11-8: 2D PHA Histogram with Rate-Weighting applied.

12. REX INSTRUMENT DESCRIPTION

12.1 Overview

The primary purpose of the REX system is to investigate open questions regarding the atmospheric and ionospheric structure, surface conditions, and planetary radii of both Pluto and Charon.

The REX instrument is unique among the suite of instruments comprising the New Horizons payload in that it is physically and functionally incorporated within the spacecraft telecommunications subsystem. REX consists of both a 'Flight Element' carried on-board the New Horizons spacecraft, and a 'Ground Element' comprising the existing Earth-based NASA Deep Space Network transmitting and operations facilities, which radiate an uplink signal that is sampled and measured by REX on-board the spacecraft.

REX is designed to fulfill the mission objectives by performing the following distinct experiments:

1. A radio occultation experiment, designed to detect and measure the atmosphere, ionosphere and size of Pluto, and of Charon where detectable. The spacecraft will be maneuvered so that Pluto, and then Charon, pass through the line of sight from Earth to the spacecraft. That line of sight is coincident with the uplink signal path from the Ground Element, and so Pluto and Charon will effect changes in the signal received and measured by REX. The experiment will detect phase differences between the uplink signal as measured by REX, and a modeled signal which would be expected if there were no occultations. Subsequent analysis of the behavior of those phase differences over time, combined with knowledge of the ephemerides of Pluto, Earth and the spacecraft, will be used to deduce atmospheric temperature and pressure profiles down to the surface of Pluto (and of Charon, should it be found to have a sensible atmosphere), as well as electron and ion densities of Pluto's (and possibly Charon's) ionosphere. Analysis of the on-board-measured uplink signal strength as the spacecraft goes in and out of occultation will be used to deduce the chord lengths of the line of sight path across the disks of Pluto and Charon.
2. A gravity experiment, designed to measure the independent gravitational fields of Pluto and possibly of Charon. Around the time of the occultation experiment, but with the line of sight to Earth well away from the limbs of Pluto and Charon and above any atmosphere or ionosphere, accurate tracking of Doppler shifts in the received frequency of the uplink signal, again compared to a model of what would be expected if there were no body-induced gravity fields nearby, will be used to deduce gravitationally-induced changes in velocity along the spacecraft's flight path.
3. A radiometry experiment, designed to measure the spatially averaged surface emission brightness at a wavelength of 4.2 cm (7.182 GHz, the nominal operating frequency of the New Horizons radio) of Pluto and of Charon. The dark-side emissions will be measured during the occultation interlude. The day-side emissions will be measured as is operationally feasible.

In those first two experiments the on-board REX system hardware downconverts and samples an uplink signal from the Ground Element (Earth-based Deep Space Network; DSN) for the purpose of analyzing the frequency and phase behavior of that signal compared to an on-board oscillator. In the third experiment the on-board hardware measures (integrates) the radiometric emission of a source.

Note that this section's focus, and the PDS archive data sets produced from REX data, comprise samples taken and measurements made *on-board* the spacecraft *by REX* either of a one-way uplink signal from the Ground Element (DSN), or of 4cm-wavelength (7.2GHz) radiation from a planetary surface, from an astronomy source, or from cold sky.

Further note that, at the time this is being written, about a year before the Pluto Encounter, almost all REX observations using one-way uplink data to-date have been instrument functional tests, instrument characterizations, and instrument calibrations. As such, there is *no need* for tuning profiles of the one-way uplink data to analyze those observations. The only exceptions are Lunar Occultations in May of 2011 and January of 2012; Tracking and Navigation Files (TNFs; TRK-2-34 files) with uplink tuning profiles will not be covered here, but will be delivered with PDS data sets containing the lunar occultation data; these data are described by PDS labels and by DOCUMENT/TNFSIS.LBL in those data sets.

Finally note that Earth-spacecraft-Earth non-coherent (a.k.a. one-way mode) tracking data, with measurements made *at the Ground Element (DSN)* of signals sent from REX, are *not processed* by the SOC pipeline, are *outside the scope* of this document, and are *not included* in any REX PDS data sets. At the time this is being written, about a year before the Pluto encounter, there have been no non-coherent tracking data taken for science, only for navigation. The disposition and archiving of non-coherent tracking data to be taken around the Pluto encounter for gravity investigations is TBD.

The heart of the REX instrument is an Actel Field Programmable Gate Array (FPGA) that takes samples of the downconverted & digitized intermediate frequency (IF) receiver output and generates wideband radiometer and narrowband sampled signal data products. The REX hardware also includes an analog-to-digital converter (ADC) and other direct interface components, and by extension all of the RF telecommunications system hardware along the uplink (receive) path from the High Gain Antenna (HGA) to the input to the ADC.

Stanford is responsible for the FPGA design and system analysis. APL is responsible for the design of the telecommunications system and incorporating the REX FPGA system therein.

The interfaces to the REX FPGA (see Figure 12-1) include a 30 MHz clock signal from the Ultra-Stable Oscillator, (USO), the secondary power connections, the command and telemetry data interfaces to the Uplink Card, the high-speed data interface to the Instrument Interface Card, a 1 PPS signal for data framing, and the interface to the ADC, where the wideband IF signal from the Uplink Card is sampled.

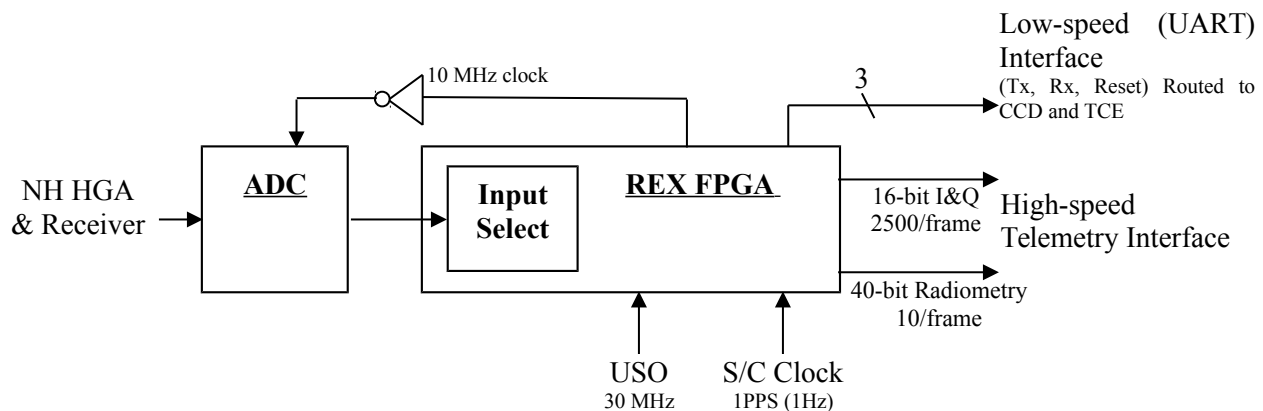

Figure 12-1: Electrical Interfaces to the REX FPGA

The input to the REX FPGA is normally the uplink signal from the DSN after being filtered by a 4.5 MHz bandpass filter (not shown) and digitized by the ADC at a sample rate of 10 Msamples/s. The Input Select function, commandable via uplink, allows the FPGA to process any of seven predetermined digital signals for testing the FPGA functionality (see the ROF Status Byte section below).

12.2 Raw Data Specifics

After REX receives a power-on command, on the next 1PPS strobe from the spacecraft clock the REX FPGA starts generating a continuous stream of data containing In-Phase & Quadrature-Phase value pairs as well as integrated radiometer values. This stream of data is divided into fixed-length units called REX Output Frames (ROFs) at a rate of one ROF per 1.024s (s implies seconds on the spacecraft clock in this section). The ROFs are stored on the spacecraft solid state recorder (SSR), and eventually played back via the High-Speed Telemetry interface to the DSN and arrive at the SOC as raw telemetry packets.

REX continues to generate ROFs until turned off. Each ROF also contains Time Tags that may be used to verify that a sequence of ROFs is a contiguous set. If REX is turned off while writing data to the SSR, the data at the end of the last ROF in a contiguous sequence of ROFs *may* comprise random bits. It is up to the user to assess where this has occurred; in general the last ROF of a sequence can be ignored.

The In-Phase, Quadrature-phase, Radiometer, and Time Tags are all multi-byte values, and the individual bytes for all quantities are interleaved throughout the ROF.

12.2.1 Raw Data Format

The SOC Raw pipeline decommutates each ROF from telemetry and places it into the Primary Data Unit (PDU) of an individual FITS file. Each PDU is stored as a one-dimensional image of 5088 bytes: the first 5082 bytes are the ROF; the last 6 bytes in the PDU are spare.

The SOC Raw pipeline also looks in the telemetry for packets corresponding to the time of the ROF, and places them in Extension Data Units (EDUs). Specifically, data from spacecraft housekeeping ApIDs (packet Application Process IDentifiers; also Application IDs) 0x004, 0x016, 0x084 and 0x096 as well as from Thruster packets are placed in EDUs 1 through 5, respectively, of the Raw FITS files.

12.2.1.1 PDU Content

Each ROF contains the items listed in Table 12-1, with the individual bytes in an interleaved format:

Item	Item Description	Count/ROF	Bytes/item	Total bytes
ID byte	ROF Identifier = 0xB7	1	1	1
Status byte	Input select	1	1	1
Radiometry	40-bit integrated power; reset each ROF	10	5	50
Time tag	24-bit accumulator	10	3	30
I&Q value pair	In-phase & Quadrature @ 16 bits	1250 (pairs)	(2 + 2 =) 4	5000

Table 12-1: REX Output Frame Contents

12.2.1.1.1 ROF ID byte

The ID byte is the first byte in the ROF and should always have the same value; see Table 12-2:

Unsigned Decimal	Hexadecimal	Binary
183	B7	1011 0111

Table 12-2: REX Output Frame ID byte value

12.2.1.1.2 ROF Status byte

The ROF Status byte is the fourth byte in the ROF. In bit positions 6, 5 & 4 (bit position 7 is the most significant bit = $128 = 2^7$; bit position 0 is the least significant bit = $1 = 2^0$) it contains the three bits that make up the Input Select setting for the ROF; all other bits are normally zero, otherwise corruption should be suspected. When Input Select is set to any of its non-zero values, the ADC output is replaced as the FPGA input with a predetermined 10Msample/s signal as described in Table 12-3. In that case, the output of the REX FPGA should be deterministic and known, and may be compared bit-for-bit against the expected output as a limited check on the health of the FPGA as well as that of the Input Select system.

Input Select (binary)	Status Byte (binary)	Input Select description
000	0000 0000	ADC output from NH receiver system (default)
001	0001 0000	Impulse: 2 samples (200ns) of value 128 at the start of each ROF, followed by zeroes
010	0010 0000	Low-Frequency Square Wave: +/-256 @ 610.3515625 Hz
011	0011 0000	Mid Frequency Square Wave: +/-256 @ 19.53125 KHz
100	0100 0000	Pseudo-Random Number (PRN) of value +/-1 @ 10 MHz
101	0101 0000	Pseudo-Random Number full scale @ 10 MHz
110	0110 0000	Hi Frequency Square Wave: +/-256 @ 78.125 KHz)
111	0111 0000	All zeroes

Table 12-3: REX Input Select & Status Byte values

12.2.1.1.3 Integrated Radiometry values

The details of how incoming power is used as radiometry are given in Tyler et al., 2008.

The FPGA integrates the incoming power from its input signal by squaring and summing the ~10Msamples/s that compose its input. Ten accumulating radiometry values are stored in each ROF, and the FPGA resets the value to zero at the start of each ROF. Each radiometry value comprises 40 bits, or 5 bytes, as an unsigned integer, and the bytes are in MSByte-first order, interleaved with I&Q values.

The time interval between radiometry values is one-tenth of a ROF or 102.4ms. In each ROF, REX stores an integrated radiometry value at the start time of that ROF (and not 102.4ms after its start), so the tenth, or last, radiometry value of associated with a ROF (i.e. the one that represents a full 1.024s of integration time) is actually stored as the first radiometry value in the following ROF.

12.2.1.1.4 Time Tag values

REX places ten incrementing time tags in each ROF. The first time tag of the first ROF after a start command is zero, and following time tags increment by one. The time tag is not reset at the start of each ROF. Each time tag value comprises 24 bits, or 3 bytes, as an unsigned integer, and the bytes are in MSByte-first order, interleaved with I&Q values. Each increment of the time tag represents 102.4ms. The rollover time is about a fortnight and a half (16.7Ms) and will never be reached in practice.

The time tags can be used both to identify any breaks in a sequence of ROFs, and to determine the time between any two ROFs within a sequence.

12.2.1.1.4.1 Time tag anomalies in ROF sequences

The normal sequence for time tags is to start at zero in the first ROF and increment ten times per ROF, so first time tag of the second ROF is 10, that of the third ROF is 20, etc. The time tags continue to increment until either REX is turned off or the high-speed allocation for the observation in the Solid-State Recorder (SSR) is full. In practice, the first and last ROFs in a sequence do not always show simple zero starts and clean finishes, respectively; the first time tag may be 10, or it may continue from the previous ROF sequence before resetting to zero; the time tags in the last ROF often start correctly for the first few but then drop to zero for the final values. This can be due to the compression issue mentioned elsewhere, but has also been observed with uncompressed data. These time tag anomalies indicate data corruption in just those starting and ending ROFs, but there is no indication of corruption elsewhere within ROF streams. REX commanding ensures there are always adequate ROFs before and after any observation, so discarding starting and ending ROFs in a sequence based on simple inspection of time tags is the way to handle this issue.

12.2.1.1.5 I & Q value pairs

Each ROF contains 1250 pairs of In-Phase (I) & Quadrature-Phase (Q) values. Each I value and each Q value comprises 16 bits or two bytes as a twos-complement signed value.

The process of down conversion from 10 Ms/s is accomplished by heterodyning to zero frequency the uplink carrier signal centered initially at the 2.5MHz Intermediate Frequency (IF) center frequency, followed by use of time-invariant baseband filters to reduce the bandwidth. The details are too extensive to include here, but are explained in detail in Tyler et al. (2008).

12.2.1.2 Method 1 - values' bytes' layout within ROF: Interleaving

In each ROF, the bytes of the ID, Status, Radiometry and Time Tag values are interleaved with the I&Q value pairs, but none of the values start or end on other than a byte boundary. There are two methods to describe such an arrangement: describe the layout of the bytes of the data values as a sequence bytes from the ROF; describe the layout of the ROF as built out of a sequence of bytes extracted from the de-interleaved data values (ID, Status, Radiometry, Time Tag, I&Q). Both methods will be described here, the former first as it lends itself more easily to writing computer code to build the data values by extracting bytes from the ROF. Indeed, IDL(tm) and Python routines to de-interleave ROF data exist each with less than two dozen statements.

Item, Item Size (bytes), Item Count	First (MSB) byte of first value (1-based)	Offset to succeeding byte(s) within an Item	Byte Offset(s) to successive Items	First (MSB) byte of first value (0-based)
ID byte, 1, 1	1	N/A	N/A	0
Status byte, 1, 1	4	N/A	N/A	3
Radiometry, 5, 10	7	3	508	6
Time Tag, 3, 10	22	3	508	21
I, 2, 1250	2	1	6 & 4	1
Q, 2, 1250	5	1	6 & 4	4

Table 12-4: Data values' bytes' positions and offsets within an ROF. For example, there are 10

Radiometry values, each comprises 5 bytes (1st column, Radiometry row). The first Radiometry value comprises the 7th (2nd column), then 10th, 13th, 16th, and 19th bytes (3rd column) of the ROF. The second Radiometry value comprises the 515th (7+508; 4th column), then 518th, 521st, 524th, 527th bytes of the ROF.

The following sections use the notation in Table 12-5 to and/or locate the various quantities' bytes within the ROF (Method 1), or vice versa (Method 2):

ROF[N]	Nth byte of ROF (N=1 to 5082), interpreted as an unsigned integer (Range is 0 to 255)
R[I]	Ith Radiometry value; I=1 to 10
T[J]	Jth Time Tag value, J=1 to 10
I[K] or Q[K]	Kth In-phase (I) or Quadrature-phase (Q) value, K=1 to 1250
X[M:N]	Bits M through N of multi-byte quantity X. E.g. R[10][31:24] second byte of R[10]
Y[MSB]	The MSByte, as an unsigned integer, of a 16-bit signed IQ value Y; Y[MSB] = Y[15:8]
Y[LSB]	The LSByte, as an unsigned integer, of the a 16-bit signed IQ value Y; Y[LSB] = Y[7:0]
O _i	A useful offset quantity equal to (508 * (i-1))

Table 12-5: Notation used in this section

12.2.1.2.1 Method 1 - Layout of ID & Status bytes

The ID and Status bytes are the first and fourth bytes in the ROF, respectively, and can simply be obtained from the ROF as such as there are no following bytes or values:

ID byte = ROF[1]

Status byte =ROF[4]

12.2.1.2.2 Method 1 - Layout of Radiometry bytes

The first byte of the first radiometry value is the seventh byte of the ROF, and the following four bytes of that first radiometry value are each offset by three bytes from the previous byte. The order is MSByte-first. So, the first radiometry value of a ROF may be calculated from the following formula:

$$R[1] = ((ROF[7] * 256 + ROF[10]) * 256 + ROF[13]) * 256 + ROF[16]) * 256 + ROF[19]$$

The following radiometry values' bytes in the same ROF are each offset 508 bytes from the previous radiometry value's bytes. So, more generally:

$$R[i]=(((ROF[7+O_i]*256 + ROF[10+O_i])*256 + ROF[13+O_i])*256 + ROF[16+O_i])*256 + ROF[19+O_i]$$

12.2.1.2.3 Method 1 - Layout of Time Tags' bytes

The first byte of the first time tag value is the 22nd byte of the ROF, and the following two bytes of that first radiometry value are each offset by three bytes from the previous byte. The order is MSByte-first. So, the first time tag value of a ROF may be calculated from the following formula:

$$T[1] = (ROF[22] * 256 + ROF[25]) * 256 + ROF[28]$$

The following time tag values' bytes in the same ROF are each offset 508 bytes from the previous radiometry value's bytes. So, more generally:

$$T[i] = (ROF[22+0i] * 256 + ROF[25+0i]) * 256 + ROF[28+0i]$$

12.2.1.2.4 Method 1 - Layout of I & Q values' bytes

The bytes that are used to store the I & Q values alternate in sequence (I[1], Q[1], I[2], Q[2], I[3], Q[3], ..., I[1250], Q[1250]) as 16-bit MSByte-first two's complement signed integers, that cover all of the bytes not used by the other values (ID, Status, Radiometry, Time Tags) above.

Specifically, Table 12-6 describes how ROF bytes are used to calculate I[K] and Q[K] for K=1 to 1250:

KMOD	KMOD = (K+123) MOD 125	
j	j = (K+123-KMOD) / 125	
0j	0j = 508 * (j-1)	
K=1	I [K] = IQ(ROF [2],	ROF [3])
	Q [K] = IQ(ROF [5],	ROF [6])
K>1 & KMOD<4	I [K] = IQ(ROF [8+KMOD*6+0j],	ROF [9+KMOD*6+0j])
	Q [K] = IQ(ROF [11+KMOD*6+0j],	ROF [12+KMOD*6+0j])
K>1 & KMOD>3	I [K] = IQ(ROF [15+KMOD*4+0j],	ROF [16+KMOD*4+0j])
	Q [K] = IQ(ROF [17+KMOD*4+0j],	ROF [18+KMOD*4+0j])

Table 12-6: I & Q values from ROF

Where Function IQ(MSByte,LSByte) is defined as (with MSByte & LSByte interpreted as unsigned 8-bit - i.e. 1-byte - integers)

$$IQ(MSByte,LSByte) = 256 * MSByte + LSByte$$

if MSByte is between 0 and 127 inclusive. Otherwise, it is defined as

$$IQ(MSByte,LSByte) = 256 * MSByte + LSByte - 65536$$

12.2.1.3 Method 2 - Layout of ROF

The tables below have one cell per ROF byte, and indicate which data values (ID, Status, Radiometry, &c) each byte contributes to. The order of bytes in these table is left-to-right and down i.e.

ROF [1]	ROF [2]	ROF [3]
ROF [4]	ROF [5]	
ROF [6]	ROF [7]	
...	...	

The first six ROF bytes contain the ID & Status bytes and the first I&Q pair:

ID	I [1] [MSB]	I [1] [LSB]
Status	Q [1] [MSB]	Q [1] [LSB]

The next 508-byte "chunk" (again, ROF byte order is left-to-right then down) contains one Radiometry value, one Time Tag, and 125 I&Q pairs:

R[1][39:32]	I[2][MSB]	I[2][LSB]
R[1][31:24]	Q[2][MSB]	Q[2][LSB]
R[1][23:16]	I[3][MSB]	I[3][LSB]
R[1][15:8]	Q[3][MSB]	Q[3][LSB]
R[1][7:0]	I[4][MSB]	I[4][LSB]
T[1][23:16]	Q[4][MSB]	Q[4][LSB]
T[1][15:8]	I[5][MSB]	I[5][LSB]
T[1][7:0]	Q[5][MSB]	Q[5][LSB]
I[6][MSB]	I[6][LSB]	
Q[6][MSB]	Q[6][LSB]	
I[7][MSB]	I[7][LSB]	
Q[7][MSB]	Q[7][LSB]	
I[8][MSB]	I[8][LSB]	
Q[8][MSB]	Q[8][LSB]	
...	...	
I[126][MSB]	I[126][LSB]	
Q[126][MSB]	Q[126][LSB]	

The rest of the ROF comprises 9 more chunks of 508 bytes per chunk, essentially identical to the one above, incrementing the R[] & T[] indices by one per chunk, and incrementing the I[] & Q[] indices by 125 per chunk. Each chunk except the last contains 125 I&Q pairs; N.B. the tenth chunk ends after its 504th byte and after its 124 I&Q pair which is the 1250th, and last, I&Q pair of the ROF.

12.2.2 Data Sources (High/Low Speed, CCSDS, ITF)

REX data are in the high-speed stream and come to the SOC in CCSDS (Consultative Committee for Space Data Systems) packets.

12.2.3 Definition of an "Observation"

One REX Output Frame (ROF), as defined above, is an observation.

12.2.4 Data and housekeeping in Raw FIT files' PDU and EDUs

The Raw pipeline puts the raw ROF into the Primary Data Unit (PDU; a.k.a. EDU "0"), and puts ROF-derived information (I/Q pairs, Radiometry, Time Tags), plus several types of housekeeping (HK) packets, as FITS binary tables (BINTABLEs) into Extension Data Units (EDUs) 1 through 8 (see Table 12-7). The pipeline attempts to find the closest HK packet to the observation time. If no packet is available, the

EDU data are not present and the corresponding Extension Header Unit (EHDU) will indicate a zero-sized EDU.

#	<u>EXTNAME</u>	<u>Cal</u>	<u>Description</u>
0	N/A	No	Raw ROF (REX Output Frame)
1	I AND Q VALUES	Yes	1250 (In-, Quadrature-phase) value pairs
2	RADIOM. AND TIME	Yes	Radiometer and Time Tag values (10 each)
3	HOUSEKEEPING_0X004	No	Phase Locked Loop HK from ApID 0x004
4	HOUSEKEEPING_0X016	No	REX HK from ApID 0x016
5	HOUSEKEEPING_0X084	No	Phase Locked Loop HK from ApID 0X084
6	HOUSEKEEPING_0X096	No	REX HK from ApID 0x096
7	THRUSTERS	No	Thruster HK from ApID 0x124
8	SSR_SECTOR_HEADERS	No	SSR sector header information (Note 1)

Table 12-7: REX RAW (AND CALIBRATED; see Section 12.3.2 below) FITS PDU (a.k.a. EDU 0 or DU 0) and EDU Numbers, Names, Calibration relevance, & Descriptions. Extension with calibration-relevant have "Yes" in the "Cal" column. Extensions 3-8 are irrelevant to PDS users.

12.2.4.1 FITS keywords added to PDU (a.k.a. EDU 0 or DU 0)

The Status byte is added to the PHDU (FITS header of PDU).

12.2.4.2 FITS BINTABLE specifics

12.2.4.2.1 Extension Data Unit (EDU) 1 - I & Q values

The In-phase and Quadrature-phase values are each combined from two ROF bytes as described above and stored as signed 16-bit values in their respective columns (TFORM_n = I; TFORM_n is a keyword in EDU BINTABLE header and declares the format of table column n; a value of I indicates a 16-bit integer; refer to FITS reference given in Section 3 for more detail).

The BINTABLE comprises 1250 rows, and each row comprises two columns laid out over four bytes.

12.2.4.2.2 EDU 2 – Radiometry and Time Tags

The Radiometry values are each combined from five ROF bytes as described above, and stored within signed 64-bit integers in the first column of the BINTABLE (TFORM1 = K).

The Time Tag values are each combined from three ROF bytes as described above, and stored within signed 32-bit integers in the second column of the BINTABLE (TFORM2 = J).

The BINTABLE comprises 10 rows, and each row comprises two columns laid out over twelve bytes.

12.2.4.2.3 EDUs 3 through 8 – Housekeeping

The remaining BINTABLES contain housekeeping information and are there for historical reasons and for diagnostics performed by the science team, and will not be described here. PDS users may safely ignore them.

12.2.5 Note for PDS users reading FITS files

There are many FITS libraries that render trivial the reading of data from any PDU or EDU in a FITS file.

If however the PDS user, for whatever reason, still desires to write their own access routines, then we recommend they should instead use the detached PDS labels as a data map. PDS labels provide, in both machine- and human-readable form, a simple arithmetic path to interpret the bytes in these FITS files.

12.2.6 Raw Science Data and/or Housekeeping Requirements

Radio receiver housekeeping (ApIDs 0x004 and/or 0x084 noted above).

12.3 Calibration Specifics

12.3.1 Calibration Algorithms

The conversion of RAW REX data to Calibrated data is concerned with three data streams from REX:

- (1) the REX filter output, comprising 16-bit samples at 1250 samples (complex) per ROF, i.e., 1250 In-phase samples per ROF and 1250 Quadrature-phase samples per ROF, and
- (2) the Radiometer output, comprising 40-bit samples at a rate of 10 samples per ROF, and
- (3) the Time Tags, 10 per ROF.

12.3.1.1 Calibrating the REX filter output: In-phase & Quadrature-phase values

The conversion of the I/Q samples from the raw DN to calibrated physical units (milliVolts) involves applying a gain-independent scaling, since the FIR process producing the samples has no adjustable parameters.

The algorithm takes each I or Q raw **FilterValue** that represent a single filter output value and does the following:

- Scale the filter value by the ratio of the ADC input range ($\pm 1V = \pm 1000mV$) to its output range ($\pm 2^{13}$; the ADC output values are 14-bit, twos-complement integers):
 - $mV_{IorQ} = (1000 / (2^{13})) * FilterValue$

12.3.1.2 Calibrating the REX Radiometry

The formula for converting the Raw REX radiometer data to power, in units of dBm, is as follows:

$$dBm = -172 + 10 * \log_{10}(4.5e6 * \delta Samp) + Ro \\ - (16 * AGC - AGCoffset) / dBstep + ant_dBm$$

where

$$\delta Samp = \text{Increase in raw (40-bit) 64-bit integer value from ROF (raw FITS BINTABLE)}$$

- There are ten raw (accumulating) values stored in column 1 of EDU 2 in the raw file. The equation above applies to the delta of each raw value from the previous one.
- The increase corresponding to each raw value is the difference between it and the previous raw value, with two exceptions:
 - If the first raw value in the column is greater than the second, then that first raw value is actually the tenth accumulating raw value from the previous ROF. In order to confine the calibration to the current FITS file, the pipeline uses the expedient of dividing such accumulated raw first values by ten and using the result as a proxy for the increase from the last raw value from the previous ROF/raw FITS file.
 - In that case (1st > 2nd), nothing is subtracted from the second value.

Ro = Constant: -93.170

- AGC** = AGC setting from whichever REX Side, A or B, generated the data being calibrated.
- A state table of commanded, per-Side AGC settings as a function of time, derived from SeqGen SSF output files, is stored in the Uplink DataBase (UplinkDB) on the SOC, and in TABLEs AGCGAINA and AGCGAINB for PDS data sets, and
 - when creating the raw FITS file, the pipeline retrieves the appropriate value based on the observation time of the FITS file and the side (ApID: 0x7b0 and 0x7b1 are side A; 0x7b2 and 0x7b3 are side B), and puts it into the FITS header as keyword AGCGAIN. For observations before the state table, use 167 or 163 for Side A or B, respectively.
 - The calibration code retrieves the value from the FITS header when calibrating the data.

Name	Description	Side A Value (0x7b0; 0x7b1)	Side B Value (0x7b2, 0x7b3)
AGCoffset	REX Side-dependent constant; AGC setting offset	2512	2304
dBstep	REX Side-dependent constant; size of AGC setting increase for a decrease of 16 in the dBm	32.5	34
ant_dBm	REX Side-dependent constant	1.33	1.23

12.3.1.2.1 Radiometry calibration

The Ro dBm offset constant was set based on Cold Sky and radio source radiometer observations taken in June, 2006 and elsewhere throughout the mission. The gain-related coefficients are based on gain linearity tests where the gain is stepped through several values while receiving a fixed-amplitude signal from the DSN.

12.3.1.3 Calibrating the REX Time Tags

The time tags are 24-bit integers, stored as 32-bit integers in the FITS BINTABLE, that increment ten times per ROF frame of 1.024s and represent the time since the first contiguous ROF frame in a sequence

(or, in the unlikely case of REX taking data for more than about a fortnight and a half, from the last Time Tag rollover), so the formula to convert from the 24-bit Time Tag value TTraw to seconds is

$$T_s = T_{\text{Traw}} * 0.1024 \quad \text{*** N.B. relative spacecraft seconds}$$

12.3.2 Calibrated FITS file data format

The calibrated data from each ROF are stored in a single FITS file. The data layout in the PDU and EDUs is similar to that of a raw data FITS file (see Table 12-7); the PDU containing the raw ROF data and BINTABLES in EDU 3 through 8 containing HK data are identical; the only differences are that

- in the EDU 1 BINTABLE, the I&Q, pairs the Radiometry and the Time Tags have been calibrated to units of mV, dBm and s, respectively, and
- in the EDU 2 BINTABLE, the radiometry power values are derived from rates – differences between successive accumulating values - instead of the accumulating values themselves, and
- all values are converted to scientific units (see section 12.3.2.3) stored in the FITS file as 32-bit floating point values.

12.3.2.1 Extension Data Unit (EDU) 1: I & Q values

The first extension of the Calibrated FITS file is a FITS BINTABLE, containing the calibrated I&Q value pairs in units of milliVolts.

The BINTABLE comprises 1250 rows, and each row comprises two columns laid out over eight bytes.

12.3.2.2 EDU 2: Radiometry & Time Tags

The second extension of the Calibrated FITS file is also a FITS BINTABLE, containing two columns: Radiometry values in dBm; Time Tags in seconds.

The BINTABLE comprises 10 rows, and each row comprises two columns laid out over eight bytes.

12.3.2.3 Scientific Units

The units of the calibrated values, after applying the scaling factors if present, are as follows:

Filter outputs (IQ pairs):	Voltage (mV)
Radiometry:	Power (dBm)
Time Tag:	Relative spacecraft time (s)

12.3.2.4 Additional FITS and PDS Keywords

12.3.2.4.1 Keywords added to raw Raw and Calibrated PHDUs

```
FSTATUS = '0x00      ' / Raw status byte from TLM
AGCGAIN =              158 / AGC Gain
AGCSRC  = 'ULCMD    ' / Source of AGC Gain info
AGCPROV = '06361.ssf:CORX04b_01_GainLin$2REX_50CMD,158' / Provenance
```

12.3.2.4.2 Provenance added to Calibrated PHDU

```
RADRAD__ = '*** Radiometry formula and coefficients:'
RADRADIO= 'dBm=-172+10*log10(4.5e6*RAW)+RO-(16*AGC-AGCOF)/DBSTP+ANTDB'
RADRO    =              -96.8700
RADAGC   =              158.0000
RADAGCOF=              2304.0000
```

New Horizons SOC to Instrument Pipeline ICD

```
RADDBSTP=          34.0000
RADANTDB=          1.2300
RADIQ___ = '*** I&Q formula:'
RADIANDQ= 'mV = (1000 / (2^13)) * RAW = KIQ * RAW'
RADKIQ   =          0.1221
RADTT___ = '*** Time Tag formula:'
RADTIMTG= 's = 0.1024 * RAW = DT * RAW'
RADDT   =          0.1024
```

12.3.3 Hardware/OS Development Platform

PC/Linux

12.3.4 Language(s) Used

Python (Telemetry to Raw); C (Raw to Calibrated)

12.3.5 Third Party Libraries Required

cfitsio (where C used) or Pyfits (where Python used)

12.3.6 Calibration Files Needed (with Quantities)

AGC gain table, in the UplinkDB on the SOC, and in DOCUMENT/AGCGAIN{A,B}.* in PDS data sets. All other calibration factors are in the source code and listed above.

12.3.7 Memory Required

< 128MB

12.3.8 Temporary File System Space Needed

None.

12.3.9 Predicted Size of Output File(s)

< 70 Kbyte

12.3.10 Predicted Execution time

Less than a second per ROF

12.3.11 Contact/Support Person(s)

Ivan Linscott

12.3.12 Maintenance Schedule (Code/Data Updates, Documentation)

None planned; something may come out of the PDS review.

13. SDC INSTRUMENT DESCRIPTION

13.1 Overview

The mission of the Venetia Burney Student Dust Counter (VSDC, but typically just SDC in project documentation) is to analyze the size and distribution of dust particles along the New Horizon's trajectory to the Kuiper Belt. The SDC instrument consists of the front end analog electronics, the digital interface electronics, the detector panel, and the intraharness.

Each particle impact on one of the 12 active SDC detectors (see 13.1.1 below) will be a candidate for a science event. This impact causes a depolarization signal in the Polyvinylidene Fluoride (PVDF) detector film dependent on the size and speed of the particle. This signal gets converted to a digital number via the electronics. If the amplitude is above the value at which the threshold is currently set, then the signal is stored in memory as a science event along with other relevant housekeeping data.

These depolarization signals are measured in charge (Q) produced (Note that SDC reports charge in number of electrons. Even though this is not strictly charge, the number of electrons will from here on be referred to as the charge.) The charge from an impacting particle depends on the particles mass and velocity. Because the unit of the raw data is data number (DN), a calibration curve from data number to charge (DN=>Q) is needed. This curve is a function of box temperature and detector channel. For SDC, this curve was produced pre-flight and is checked during the mission with internal calibration procedures. The DN=>Q calibration curves are shown in Figure 13-2. The calibrated files are derived from the raw files through these curves.

13.1.1 Notes

Each detector has an independent set of electronics called a channel.

There are a total of 14 channels; there are also two inactive detectors mounted on the back of the panel, out of the path of any dust, for estimating the rate of detectable non-dust events such as spacecraft thruster firings.

Channel 11 failed before launch; it can still generate spurious data, which are processed by the pipeline, but they should be ignored.

13.2 Raw Data Specifics

The raw data are unprocessed telemetry. At the SOC and PDS, all levels of data are recorded in FITS format. The SDC team uses IDL for our data processing and hence would like to be able to load these FITS files into IDL as structures/arrays, etc. To do this we typically use an IDL fits reader which can be found in the Goddard IDL library. Specifically we use `mrdfits.pro`. If this is used, please note that a "/unsigned" flag must be given as the data are all unsigned integers.

The raw data FITS file consists of housekeeping and science data. Some of these data are not used in the calibration process to produce the calibrated data. It is stated in the PDS label files which telemetry points are and are not used by the calibration process.

In addition to the IDL functions for FITS files, generic programs such as `fv` can also be found. If opened in this program, the raw data tables are displayed in Figure 13-1 below.

Index	Extension	Type	Dimension	View					
<input type="checkbox"/> 0	Primary	Image	0	Header	Image	Table			
<input checked="" type="checkbox"/> 1	DATA	Binary	6 cols X 3 rows	Header	Hist	Plot	All	Select	
<input type="checkbox"/> 2	HOUSEKEEPING_SDC	Binary	9 cols X 1 rows	Header	Hist	Plot	All	Select	
<input type="checkbox"/> 3	HOUSEKEEPING_0X004	Binary	37 cols X 1 rows	Header	Hist	Plot	All	Select	
<input type="checkbox"/> 4	HOUSEKEEPING_0X00D	Binary	8 cols X 1 rows	Header	Hist	Plot	All	Select	
<input type="checkbox"/> 5	HOUSEKEEPING_0X00A	Binary	5 cols X 1 rows	Header	Hist	Plot	All	Select	
<input type="checkbox"/> 6	THRUSTERS	Binary	28 cols X 268 rows	Header	Hist	Plot	All	Select	

Figure 13-1: Primary Data Unit (PDU) and Extension Data Unit layout in FITS file

13.2.1 Data Format

The data in the FITS file are stored as a binary table extension. There are five tables in the raw file. These tables and their columns are :

DATA–

- 1) Copy Number – Not used in calibration
- 2) Channel ID – Detector number (0-13) [Channel 10 has a electrical issue and is not used for science. Channels 6 and 13 are reference detectors. These detectors cannot detect real dust as they are covered. For all higher level data products the channel IDs are incremented by one and become 1-14.]
- 3) Zero Fill – Not used in calibration
- 4) Threshold – First note that this DN scale is reversed. This means 65535 is a small event while 0 is a very large event. This reverse scale is also true for the Magnitude described below. The threshold value is the maximum (highest DN but smallest signal) magnitude (see next item) for accepted hits. Hits above (smaller amplitude) the threshold are rejected at the instrument level. These thresholds are adjustable and vary from channel to channel.

Note that it is SOMETIMES possible for a slightly smaller amplitude hit to come in just above this value; this is a timing effect due to the way the instrument software work. An event that triggers a measurement occurs before that measurement. The peak of the pulse from a dust event that is *below* (larger amplitude) threshold triggers a measurement, but that measurement occurs with a slight delay after its trigger event. For some events, between the time of the trigger and the time of the measurement the pulse may have decayed to very slightly *above* (smaller amplitude) the threshold, with the result that the measured and recorded Magnitude (next item) is *above* (smaller amplitude) the threshold.

- 5) Magnitude – The size of the hit in DN [Note that this scale is also reversed. This means that 65535 is a small event while 0 is a very large event.]
- 6) Time Stamp – The time the hit was recorded in Mission Elapsed Time (MET)

HOUSEKEEPING_SDC –

- 1) MET – Mission Elapsed Time
- 2) PanTemp A-D – Temperature recorded on the panel of SDC
- 3) BoxTemp 1-4 – Temperatures recorded on the electronics box of SDC

HOUSEKEEPING_0X004 – Values used in Calibration from this table:

- 1) CDH_PNL_A-D_TEMP – Temperature recorded on the panel of SDC (Note these are the same as above)
- 2) CDH_ANA_A-B_TEMP – Temperature recorded on analog side of the electronics box of SDC
- 3) CDH_ANA_DCDC_TEMP – Temperature recorded on DCDC
- 4) CDH_ANA_DCDC_TEMP – Temperature recorded on the FPGA

HOUSEKEEPING_0X00D – Values used in Calibration from this table:

- a. MET – Mission Elapsed Time for the columns in this table
- b. CDH_TEMP_SDC_ELEC – Electronics box temperature as recorded by the spacecraft
- c. CDH_TEMP_SDC_DET – Detector temperature as recorded by the spacecraft

HOUSEKEEPING_0X00A

- 1) MET - Mission Elapsed Time for the columns in this table
- 2) SDC_LVPS_VOLT – Voltage of SDC recorded by the spacecraft
- 3) SDC_LVPS_CURR – Current of SDC recorded by the spacecraft

THRUSTERS – Values used in this Table

- GC1_DATA_VALID_MET – MET of Thruster Fire

13.2.2 Data Sources (High/Low Speed, CCSDS, ITF)

- GC1_RCS_FIRE_MINOR_1-24 – Tells whether one of the thrusters fired

SDC data are low-speed CCSDS (Consultative Committee for Space Data Systems) packets only.

13.2.3 Definition of an “Observation”

One observation is one collection of events in one CCSDS packet.

13.2.4 Housekeeping Needed in Level 1 Files (for Calibration)

See Section 13.2.1

13.2.5 Raw Science Data and/or Housekeeping Requirements

From launch to the end of the first month, HK packet METs should be within 1 minute of a dust observation

From the end of the first month until Jupiter, HK packet METs should be within 1 hour

From Jupiter until the end of the mission HK packet METs should be within 1 day

For the redundant points, such as temperatures, only one of these needs to satisfy this requirement.

13.2.6 Notes about Raw Data

- 1) The scale in DN is “backwards” on a 0-65535 scale. In other words, a very large hit represent a number near 0. A small hit registers as a number close to 65535
- 2) The threshold can be tuned and represents the minimum DN of a detectable hit. HOWEVER, it is possible due to the way the electronics work, that you might get a hit with a slightly higher DN (smaller hit) than the threshold. Usually this is no more than a few tens of DN higher than the threshold.
- 3) SDC has on-board flight rules for autonomously turning a channel off. The user will then need to know when the channel was on/off. This information is in a separate file named `sdc_on_off_times.dat`.
- 4) The maximum number of recorded hits in one second on a given channel for SDC is in general 3. The way the timing works it is possible to get up to 5 hits/second. However, if more than one hit is recorded in one second (instrument wide) this is considered a coincident event and will be flagged. The science processing interprets such an event as s/c noise and removes it.

13.3 Calibration

The data calibration is a three-step process:

1. the telemetry is stored as raw DN (Section 13.2, above);
2. each DN value representing the size of a hit is converted into charge (Section 13.3.1, below);
3. each charge is converted into mass via the ground calibration results and an assumed particle velocity (Section 13.3.2, below).

Note that each event (hit) is converted to mass regardless of whether or not it is believed to be noise.

13.3.1 Pre-Flight Calibration Procedure- Charge

In a temperature controlled environment, the electronics from the end of the PVDF to the DN in the raw data were calibrated, at each of 4 calibration box temperatures and for each of the 14 channels. This was done by injecting 19 (actually 21; see below) fixed-amplitude charge pulses 100 times into a channel and recording the DN value each time. From those recorded values, the average DN (DN_{avg}) and its standard deviation (SIG) at each charge pulse amplitude, box temperature and channel were calculated. Then, for each box temperature and channel, a 9th order polynomial fit of Q(DN_{avg}) was derived. Finally, these 3 sets of values (the polynomial coefficients, DN_{avg}, and SIG) were stored in a matrix. This matrix contains all information required to calculate the charge equivalent to a DN as a function of box temperature and channel (detector), as well as the uncertainty in that calculated charge value.

13.3.1.1 Charge Calibration File

In a temperature controlled environment, the electronics from the end of the PVDF to the DN in the raw data were calibrated, at each of 4 calibration box temperatures and for each of the 14 channels. This was done by injecting 19 (actually 21; see below) fixed-amplitude charge pulses 100 times into a channel and recording the DN value each time. From those recorded values, the average DN (DN_{avg}) and its standard

deviation (SIG) at each charge pulse amplitude, box temperature and channel were calculated. Then, for each box temperature and channel, a 9th order polynomial fit of $Q(DN_{avg})$ was derived. Finally, these 3 sets of values (the polynomial coefficients, DN_{avg} , and SIG) were stored in a matrix. This matrix contains all information required to calculate the charge equivalent to a DN as a function of box temperature and channel (detector), as well as the uncertainty in that calculated charge value.

Pre-Flight Calibration Procedure- Charge Charge Calibration File

The calibration file contains the calibration values described above as a matrix of floating point values with dimension (4 X 14 X 3 X 19) representing values for the 4 box temperatures (T_{box}), the 14 channels, and the 3 types of calibration values (coefficients, DN_{avg} & SIG). The the zero-based indices have the following meanings:

First Index – 4 Box Temperatures:

- 0) 49.9deg
- 1) 40deg
- 2) 34.25deg
- 3) -7.1deg

Second Index – 14 Channels

- 0) First channel
- 1) Second channel

...

- 13) Last (fourteenth) channel

Third Index – 3 types of data.

– By setting this index you select which array of values are retrieved via the last index:

- 0 – Coeffs - Polynomial fit coefficients (in practice only the first 10 are used)
- 1 – DN_{avg} - Average DN recorded during Calibration at this T_{box} & Channel
- 2 – SIG - Standard deviation of the corresponding average DN value (index = 1)

Fourth Index – Dependent on Third index; see also Note 1 below

- For the coefficients of the polynomial (third index = 0)
 - $\log_{10}(Q(DN)) = C_0 + C_1 \cdot DN + C_2 \cdot DN^2 + C_3 \cdot DN^3 + \dots + C_9 \cdot DN^9$
 - 0) Zeroth order coefficient, C_0
 - 1) First-order coefficient, C_1
 - N) Nth-order coefficient, C_n
- For DN_{avg} & SIG data types (third index = 1 & 2)
 - the index of each charge pulse tests arranged in order of increasing charge (decreasing DN)

Note 1: We injected charge pulses at 21 different values, but some of these were too small to record, and no channel had more than 19 recordable values at any box temperature. Also, there are only 10 coefficients in the 9th-order polynomial. So, although the matrix can hold up to 19 coefficients, average DNs or standard deviations per box temperature and channel, only the derived/recorded values are stored in the matrix, and the any unused matrix values are set to zero. This does not affect the polynomial evaluation, but when using the DN_{avg} and SIG values one should ignore zero values.

Thus from this matrix you can get 3 things: Fit coefficients, Average DNs, and standard deviations. So, for example, to get the fit coefficients for a box temperature of -7.1 degrees on the first channel you

want (-7.1, first channel, Coeff, *) => CALARRAY[3, 0, 0, *] (IDL notation). See Figure 13-2 for a plot of Charge vs DN represented by the Fit Coefficients.

For detailed information about this calibration procedure see Horanyi, et. al., “The Student Dust Counter on the New Horizons Mission”, Space Sci. Rev., in pub., 2007..

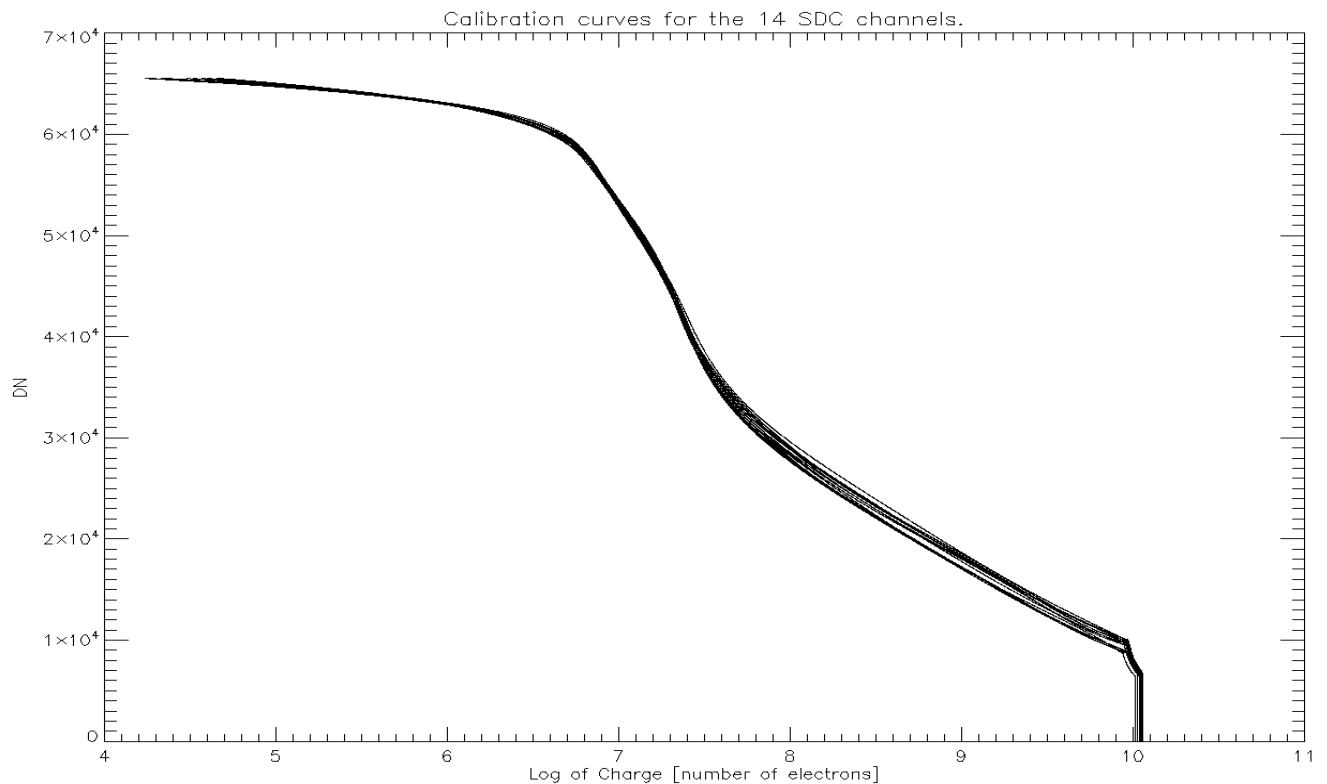

Figure 13-2: Calibration curves for SDC. All 14 channels are shown for reference.

13.3.2 Calibration – Mass

13.3.2.1 Pre-Flight and other ground-based calibrations

The mass can be derived from the charge. It was discovered by J.A. Simpson and A.J. Tuzzolino (1985) [S-T] that a particle impacting a 28 μm PVDF film (such as those on SDC) will produce a charge given by the equation:

$$N[e^-] = c \times (m[g])^a \times (v[km/s])^b$$

In this equation N is the charge in equivalent number of electrons, m is the mass in grams, v is the detector-relative particle speed in km/s; see Table 13-1 for constants a, b, and c.

Additional data were considered from tests on flight spare detectors built at the Laboratory for Atmospheric and Space Physics (LASP). Initial ground calibration results updated the constant *c* for the three-parameter model above; James et al., 2010 [JAMESETAL2010] updated all of the constants for the three-parameter model, and also proposed a four-parameter model that includes temperature dependency (T in Celcius; d is another constant in Table 13-1):

$$N[e^-] = (c + d \times T[\text{Celsius}]) \times (m[\text{g}])^a \times (v[\text{km/s}])^b$$

The New Horizons pipeline code switched to using this four-parameter model in 2013, and redelivered past PDS data (Launch and Jupiter mission phases) based on the four-parameter model in 2014.

As of March, 2014, James et al., 2010 [JAMESETAL2010] is available online at ResearchGate.net.

13.3.2.2 Mass Production

On the NH SDC instrument we have two measurements per event: the charge, N[e-]; the temperature of the detector, T[Celsius]. Thus to find either mass or velocity we must assume the other. In the pipeline we assume a Keplerian velocity for the hypothetical dust particle that produced each event, and use that to determine a mass for the event.

Note that each event is converted to mass regardless of whether or not it is believed to be noise.

Thus one can simply use the number of electrons produced and the assumed spacecraft-relative speed of the dust particle calculated through SPICE to determine the mass of the impacting particle.

Rearranging the equation for the four-parameter model above yields

$$m[\text{g}] = \{N[e^-] / ((c + d \times T[\text{Celsius}]) \times (v[\text{km/s}])^b)\}^{1/a}$$

The New Horizons pipeline code started using this equation in 2013. In 2014 the project redelivered past Launch and Jupiter mission phase SDC data to PDS based on this four-parameter model; see Table 13-1 for constants a, b, c, and d.

13.3.2.3 Constants

	Simpson and Tuzzolino three-parameter	Initial ground calbrations three-parameter	James et al., 2010 three-parameter	James et al., 2010 four-parameter
a	1.3 ± 0.1	1.3 ± 0.1	0.9343 ± 0.0009	1.052 ± 0.004
b	3.0 ± 0.1	3.0 ± 0.1	2.4 ± 0.1	2.88 ± 0.06
c	3.8 × 10 ¹⁷	5.63 × 10 ¹⁷	(6.7 ± 0.3.2) × 10 ¹²	(1.2 ± 0.1) × 10 ¹⁵
d	0	0	0	(6.7 ± 0.3.2) × 10 ¹²

Table 13-1: Constants for the mass-charge-velocity relationships; Simpson and Tuzzolino, 1985, and James et al., 2010.

13.4 Calibrated Data Specifics

13.4.1 Algorithm for Pipeline

Pre-flight calibration of the electronics box was performed to find the relationship between charge in and

DN out. This was done at 4 electronics box temperatures for all 14 channels. Fits were established from this data and the coefficients were stored in a matrix (see Figure 7 and section 13.3.1 above).

The code for Level 2 data uses the channel number and electronics box temperature to find the correct coefficients in the matrix. These coefficients are then used in a polynomial function, with the raw DN as the independent value, to calculate the corresponding charge, and then converted to mass using the equation the Mass Production equation above. For in-flight box temperatures other than the calibration temperatures represented by the first index of the calibration matrix, the in-flight charge is interpolated (or extrapolated) from the calculated charges using the two nearest calibration temperatures. Finally, in like manner using the standard deviations calibration matrix (SIG), for the nearest DN calibration measurements (DN_{avg}) and nearest two calibration temperatures, as an analog for the 1-sigma combined uncertainty of the calibration charge pulse measurement and of the calibration and in-flight DN measurement, the +/- 1-sigma masses (M_{sigplus} & M_{sigminus}) are calculated.

13.4.2 Dataflow Block Diagram

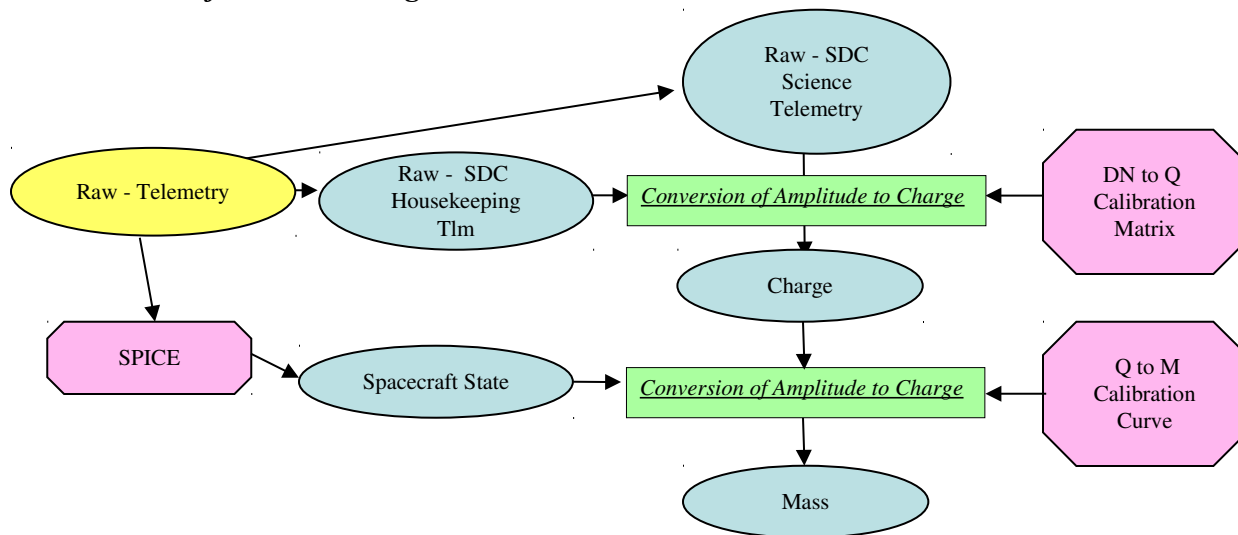

13.4.3 Data Format

The calibrated FITS file consists of science data expressed in units of number of electrons and quality flags for the PVDF detectors. The quality flags signal whether or not any of the housekeeping values were out of the standard operating range when the hit occurred. The quality flags also tell whether or not the data was extrapolated or interpolated from our pre-flight calibration curve.

Note that for scientific convenience in calibrated data, the channels are labeled 1-14 instead of 0-13.

13.4.4 Extra FITS Extensions (planes) and Their Definitions

The two tables in the calibrated FITS file are

- 1) CALIBRATED_DATA –
 - a. UTC Time



- b. MET - Time in Mission Elapsed Time (MET)
- c. Channel – [1-14]
- d. Charge [Number of Electrons]
- e. Mass [grams]
- f. Mass_Thrsh - The threshold in mass [grams]
- g. M_sigplus - Mass Plus sigma [grams]
- h. M_sigminus - Mass Minus sigma [grams]
- i. Quality_flag - Because we are susceptible to thruster firings (i.e. a thruster fire can cause false hits) a flag has been created to flag events we believe were caused by a thruster..
 - i. “OK” – No thruster firings occurred near this event
 - ii. “TF” – A thruster firing occurred within 1 second of this event and thus we believe the event was possibly caused by a thruster firing

13.4.5 Scientific Units

Charge - Number of electrons produced from impact.

Mass – Grams of impacting particle.

13.4.6 Additional FITS and PDS Keywords Added

13.4.7 Hardware/OS Development Platform

Intel, Linux or Windows

13.4.8 Language(s) Used

IDL

13.4.9 Third Party Libraries Required

JPL Astro Library downloaded from NASA at Goddard.

13.4.10 Calibration Files Needed (with Quantities)

IDL .sav file consisting of a table for fit coefficients. (TBD, <1MB)

13.4.11 Memory Required

TBD

13.4.12 Temporary File System Space Needed

TBD

13.4.13 Predicted Size of Output File(s)

Less than 1KB

13.4.14 Predicted Execution time

A few seconds

13.4.15 Contact/Support Person(s)

Level 1: Andrew Poppe, David James

Level 2: Mihaly Horanyi, David James

13.4.16 Maintenance Schedule (Code/Data Updates, Documentation)

We do have on-board calibration capabilities for the instrument and a place to insert these changes built into the code. Currently this simply multiplies by 1, but it the capability to adjust the values by some specified function remains.

14. SWAP INSTRUMENT DESCRIPTION

14.1 Overview

Solar Wind Around Pluto (SWAP) instrument is designed to measure the properties of solar wind ions for the New Horizons mission to Pluto. The bulk (thermal) solar wind ion distribution is typically Maxwellian. For most of the long journey to Pluto we expect to encounter bulk solar wind cold ion distributions that are nearly Maxwellian since the density and temperature of the solar wind decrease with increasing distance from the Sun. One notable exception is when the New Horizons spacecraft encountered Jupiter's magnetosheath. Ion distributions are known to be hot in sheath regions. Since there have been no prior in situ measurements near Pluto, we do not know if it has a well developed sheath region.

The SWAP instrument is an electrostatic instrument. The SWAP electro-optics control the energy passband of ions entering the instrument. The electro-optics has three parts: the Retarding Potential Analyzer (RPA), the Electrostatic Analyzer (ESA), and the deflector (DFL). Figure 14-1 shows a cross section of the instrument. The RPA consists of four grids with the inner two having a positive voltage, which repels ions with energies less than the corresponding potential energy (qV) (top right and left of Figure 14-1). The Electrostatic Analyzer has two parts, which are concentrically spaced, an inner dome and an outer spherical shell at ground (Figure 14-1). Only ions with a limited range of energies pass through the ESA to reach the detector.

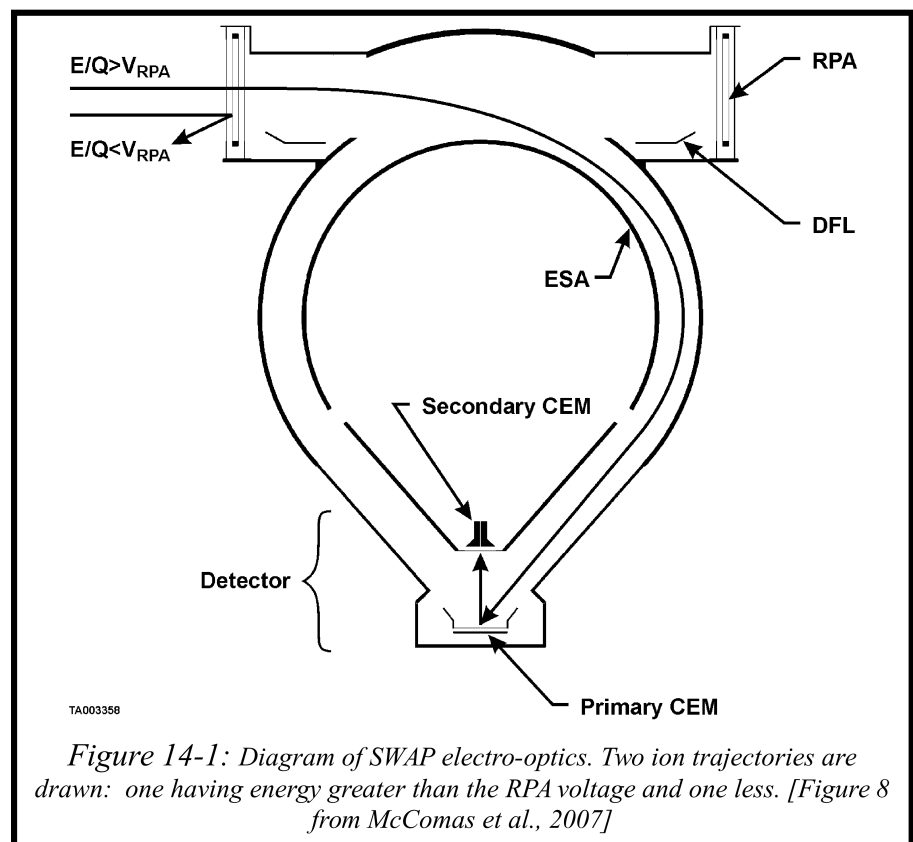

Figure 14-1: Diagram of SWAP electro-optics. Two ion trajectories are drawn: one having energy greater than the RPA voltage and one less. [Figure 8 from McComas et al., 2007]

The SWAP instrument is mounted on the $-Z_{sc}$ side of the spacecraft and the normal to the center of the aperture is aligned with $+Y_{sc}$ (Figure 14-2). Figure 14-3 shows the instrument being mounted to the spacecraft.

The deflector is used to adjust the field-of-view (FOV). That is if the solar wind, which is highly collimated (spanning only a few degrees), enters at the bottom of the RPA, the voltage on the deflector could be set so that only ions that are not part of the solar wind beam enter the instrument. This would allow pickup ions, which occur over a wide range of angles, to be studied. In the inner heliosphere the

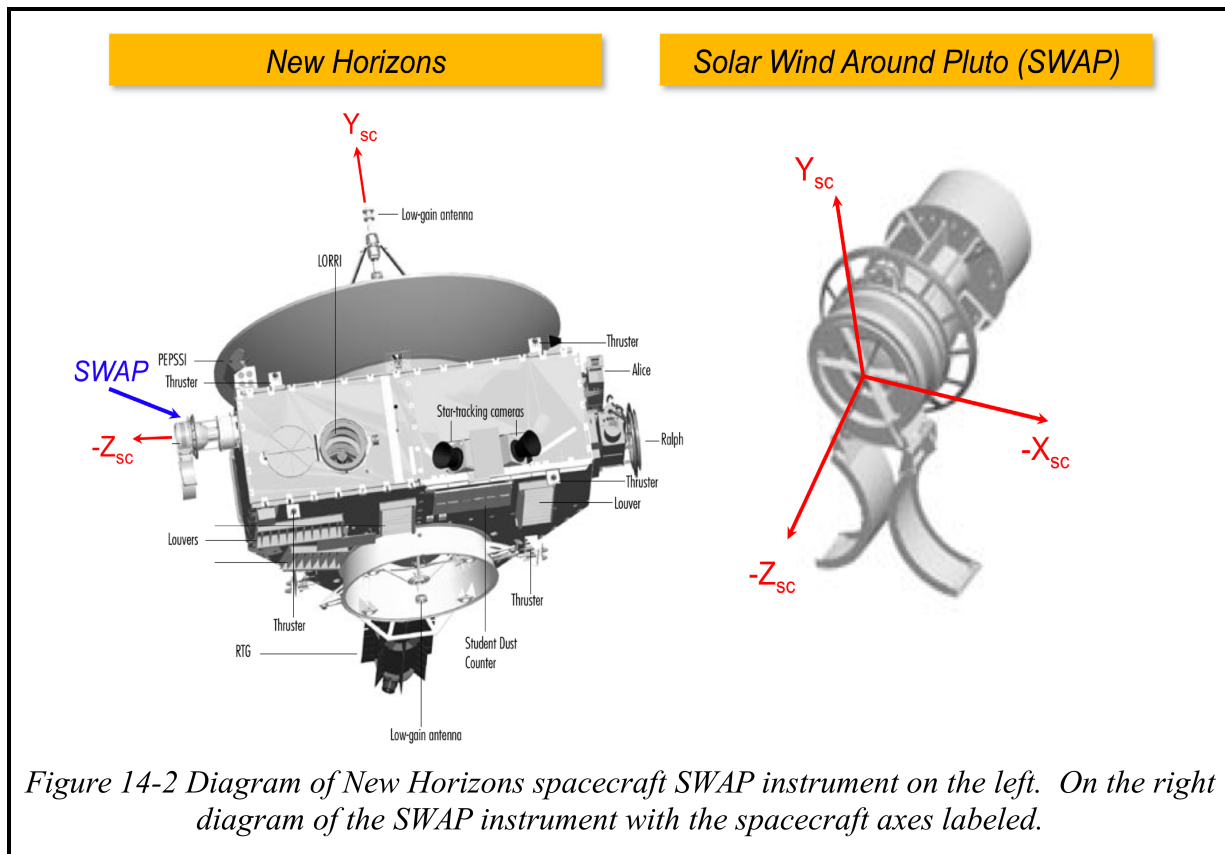

Figure 14-2 Diagram of New Horizons spacecraft SWAP instrument on the left. On the right diagram of the SWAP instrument with the spacecraft axes labeled.

pickup ions have substantially lower fluxes than the solar wind. The SWAP deflector can be used to bring the solar wind into the field of view if the solar wind beam is slightly above the top of the nominal field of view. Operating the deflector affects the energy of the ions that can enter the ESA. The RPA voltage is adjusted to compensate such that the same energy ions enter the ESA as did prior to the deflector voltage change. The deflector voltage can be automatically varied based on the commanded angle. The voltage settings for the ESA, RPA, deflector, and the amount the RPA should be adjusted to compensate for the deflector setting are all specified using lookup tables, which allow many instrument operation changes to be made by uploading new tables without having to make any software changes. Additional information on the electro-optical design is given in the introduction of section 3 and in section 3.1 in the *McComas et al.* [2007] instrument paper. The Channel Electron Multiplier (CEM) detector design is also described in section 3.1.

The SWAP instrument has two kinds of voltage scans (also called sweeps): coarse and fine. The sweeps are performed in pairs. The two possible pair options are either two back-to-back coarse scans or a coarse scan followed by a fine scan. The voltage settings are predefined with onboard voltage tables. In coarse scans large voltage steps are taken with the ESA and RPA holding the ratio of the two voltages fixed. In the fine scans we also hold the RPA and ESA at constant ratio, but take smaller steps. Our voltage tables

allow us to vary the ratio between the RPA and ESA voltages, but typically this ratio is held constant as much as possible. For high ESA voltages we cannot set the RPA to a high enough voltage to keep the RPA and ESA voltage ratio fixed because the highest RPA voltage is 2000 V and the highest ESA voltage is 4000 V. A given step number refers to a pair of RPA and ESA voltages. In the inner heliosphere we set the RPA to ESA voltage ratio high in order to narrow the passband slightly by removing ions at the low energies. All fine scans are approximately centered about the step number where the peak counts are observed in the coarse scan. To determine plasma properties from the detected count rates as a function of step number, the following calibration information is necessary: the ESA and RPA response functions, angular response function, the instrument solid angle, the detector gain, and the effective area.

Onboard there is one ESA table with 1024 steps and 4 RPA tables with 1024 steps each. For a given sweep we use the ESA table and one of the RPA tables. The different RPA tables can be used for coarse and fine scans, but for Jupiter operations we used the same RPA table for both the coarse and fine scans. In a scan/sweep the same step number is used in the software to reference rows in the ESA table and the chosen RPA table. The coarse scans use every 16th step in the 1024 voltage step lookup table where a step refers to a RPA and ESA voltage pairing. A fine scan consists of 64 steps with the coarse step at which the peak counts were detected in the middle of the fine scan.

14.2 Electronics and Flight Software

The instrument electronics are described in section 3.4 of the *McComas et al.* [2007] instrument paper. In subsequent sections of this document some information related to the flight software is provided, but further details are provided in sections 3.6 of the instrument paper.

14.3 SWAP Data Types

There are six types of SWAP science and engineering data: real-time science (0x584), summary (0x585), histogram (0x586), housekeeping, messages, and memory dump. Housekeeping, messages, and memory dump provide engineering data and the other three modes contain science data. Real-time data provide the most detailed science measurements since they contain the full count rate distribution as a function of energy (speed). For science summary and science histogram modes, the full distribution is not recorded. Instead, parameters are derived from the count rate distribution stored by SWAP. These derived parameters require less memory than storing the whole distribution. The science summary and science histogram modes are primarily used during the cruise phase of the mission.



Figure 14-3: Picture of SWAP being mounted to the spacecraft.

The real-time science data contain the full count rate energy distribution for the primary, secondary and coincidence rates. The full distribution is desired because in bow shock and sheath regions plasma distributions may not be Maxwellian. The shape of the distribution will provide valuable information

about what physical processes are occurring. In real-time mode the instrument can take measurements at a rate of 1 Hz, which is crucial for studying plasma boundaries and shocks.

Summary data consist of parameters related to the average speed, temperature, and density. The summary data are designed to study the bulk solar wind. The peak of the count distribution is related to the density, the bin location of the peak is related to the speed, and the distribution width is related to the temperature and speed combined. Along with the average values, the variance, maximum and minimum values of the peak counts, width of the peak, and energy of the peak are also recorded.

The histogram data are designed to study pickup ions. The pickup ion distribution has a characteristic shape once it is normalized by the average solar wind energy (or speed). The histogram data conserve storage space by adding up all the counts detected in given bins. The accumulation time for the histogram is variable. The bins for the histograms are not energy bins, but are bins relative the average solar wind energy (E_{sw}). The steps for the fine scan are roughly centered on the coarse scan step where the peak counts were observed allowing the energy of the solar wind to be more precisely determined in the fine scan. The energy found in the fine scan is then used to place the counts determined in the coarse ESA scan into a new large 1-D histogram array. The coarse scan count rate data array is placed into the larger histogram array such that the bin with the maximum counts in the fine scan is placed into histogram bin 1024. There are 1024 possible voltages in a given onboard voltage table. To understand the histogram data further information about the scans is necessary. Onboard there is one ESA table with 1024 steps and 4 RPA tables with 1024 steps each. For a given sweep we use the ESA table and one of the RPA tables. The different RPA tables can be used for coarse and fine scans, but for Jupiter operations we used the same RPA table for both the coarse and fine scans. In a scan/sweep the same step number is used in the software to reference rows in the ESA table and the chosen RPA table. The coarse scans use every 16th step in the 1024 step table where a step refers to a RPA and ESA voltage pairing. A fine scan consists of 64 steps with the coarse step at which the peak counts were detected in the middle of the fine scan. There are 2048 bins because the peak count rate in a fine scan could occur at any step in the fine scan, and the step in the coarse scan containing the peak counts is always placed in bin 1024.

When another set of coarse-fine scans is performed, the new array of counts is processed in a similar fashion. The new data are placed into bins such that the new peak counts aligned with bin 1024, and then added to the running total number of counts. The amount of data put into each histogram bin is tracked in a separate array. The histogram packets then consist of two 1-D vectors: one for counts in the bins and one for the number of samples placed into each bin (Example shown in **Figure 14-4**).

Housekeeping packets are included as extensions in the raw (level 2) files. Housekeeping time tags are compared to the time tags in the three types of science packets to insure that each of the three raw (level 2) files includes all the housekeeping data required for processing. Since the summary and histogram packets are assembled over an extended interval, the beginning and ending times of the measurements (included in the summary and histogram packets) are used to determine the correct housekeeping measurements.

Real-time science packets can occur at a rate as high as 1 Hz where each packet contains a set of counts, voltages, etc. Observations for 2 energy steps are stored in one packet. One observation occurs in the 1st half second and a 2nd observation occurs in the 2nd half second. The 1st and 2nd half second measurements correspond to two different steps in a given sweep. Each step consists of an RPA and ESA voltage pairing, and 64 such pairs complete either a coarse-coarse scan or a coarse-fine scan. In a coarse-coarse scan two 64 step (32 packets) coarse scans are done back to back. In a coarse-fine scan a 64 step (32 packets)

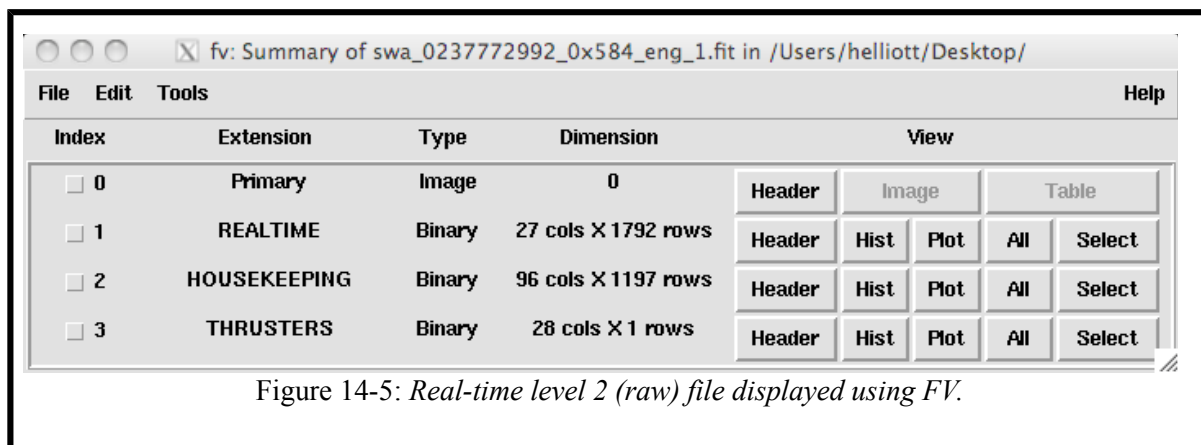

Figure 14-5: Real-time level 2 (raw) file displayed using FV.

coarse scan and then a 64 step (32 packets) fine is performed. Both a complete coarse-coarse, and a coarse-fine scan have 64 packets. There is a parameter called SWAP_RT.sec64_ST, which is included in every real-time science packet and has the value 1 at the start of a pair of scans (a set of 64 packets) and is zero otherwise. We use this parameter to insure that a 64 second cycle (pair of scans) is not split across a day.

The SWAP raw (level 2) data are arranged in a binary table such that the columns are instrument parameters and measurements, and rows are measurement times. The FITS format has a binary table that allows for columns and rows. Figure 14-7 is a picture of what the Level 2 raw real-time files look like using FITS Viewer (FV). As mentioned earlier the housekeeping data are also in a table extension. The histogram counts and the number of samples in each bin are stored as image extensions. The zeroth extension contains only the primary header, the first extension holds the real-time data, the second extension holds the housekeeping data, and the third extension holds the thruster data.

SWAP data are in CCSDS (Consultative Committee for Space Data Systems) packets packetized by the spacecraft from the low-speed bus. Note that on the New Horizons mission, every instrument also outputs a non-packetized portion of telemetry to the S/C. This portion is also called the “instrument state” and this data is incorporated into the general spacecraft housekeeping data and not into the SWAP packets. All the bits in the SWAP packets were defined for the MOC at APL in EXCEL spreadsheets in the form

required by the mission. The New Horizons SOC used the same bit level format description (APL EXCEL spreadsheets) for all the parameters in our packets to decode our raw (level 2) data.

14.4.2 Definition of an “Observation”

A complete histogram observation consists of one histogram type 1 packet and 63 histogram type 2 packets. A complete set of real-time science measurements consists of a full 64-second cycle. This is described in detail in section 14.4.1. One summary packet constitutes a complete measurement. Housekeeping data are required for all science measurements since the housekeeping data are key to interpreting the data and determining error flags.

14.4.3 Housekeeping Needed in Level 2 (Raw) Files (for Calibration)

Unlike some of the other instruments all housekeeping data for SWAP are included into the level 2 (raw) files as an extension.

14.4.4 Raw Science Data and/or Housekeeping Requirements

In addition to the complete housekeeping packets, raw summary, real-time, histogram, and thruster fire packets are included into our raw (level 2) files. The thruster data format for the raw files was reformatted to reduce space (Joe Peterson). In the calibrated (level 3) data the thruster data has been arranged by thruster name and time. The numbers in the table indicate the duration of the thruster firings.

14.5 Calibrated (Level 3) File Specifics

14.5.1 Data Format

The SWAP calibrated (level 3) pipeline requires the following input information, SWAP level 2 (raw) files which include all the housekeeping data, SWAP calibration information and engineering factors, orbit and attitude information, and spacecraft information such as thruster firings. In Figure 14-6 we show a general schematic for our level 3 (calibrated) real-time data files. The main input to the calibration pipeline are the SPICE kernels, and the raw level 2 files, which include the real-time data, thruster firings, a few minor calculations performed using SPICE in the header and the housekeeping data.

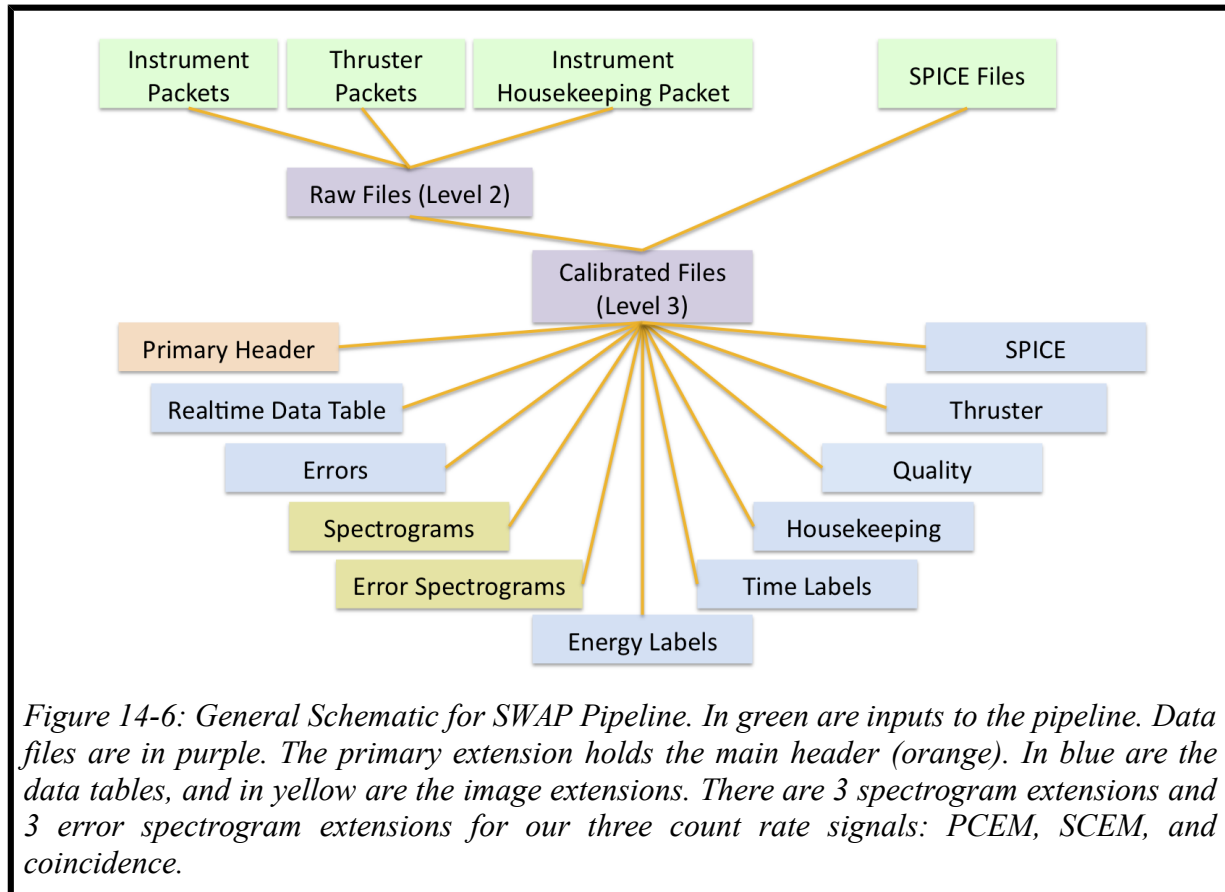

Figure 14-6: General Schematic for SWAP Pipeline. In green are inputs to the pipeline. Data files are in purple. The primary extension holds the main header (orange). In blue are the data tables, and in yellow are the image extensions. There are 3 spectrogram extensions and 3 error spectrogram extensions for our three count rate signals: PCEM, SCEM, and coincidence.

The SWAP level 3 (calibrated) analysis software has four parts corresponding to the different data (packet) types. There are simple algorithms for converting the raw data to engineering units. For example in the raw data the RPA voltage is stored as a step number for the Digital to Analog Converter (DAC), and not the actual voltage. We first make all such engineering conversions. Most information in our calibrated (level 3) files is stored in table format (blue blocks in diagram). The tables contain all the data (science and housekeeping) converted to engineering units, and counts are converted to count rate (Hz). There are extensions for housekeeping data, thruster firing data, and quality flags. In the real-time data there are additional image extensions for spectrograms derived from high voltage science real-time measurements. There are three count rate 2-D arrays for the Secondary Channel Electron Multiplier (SCEM), Primary Channel Electron Multiplier (PCEM), and coincidence (COIN) signals stored as images, and three corresponding count rate error image extensions. These errors will be based on counting statistics. In addition to the 2-D arrays, axis information is also necessary for the spectrograms. The axis information for the spectrograms are contained in two tables one with the energy per charge (E/q) and one with the time tags for each sweep. In Figure 14-7 we show a picture of what the real-time files look like when opened using the FITS viewer FV.

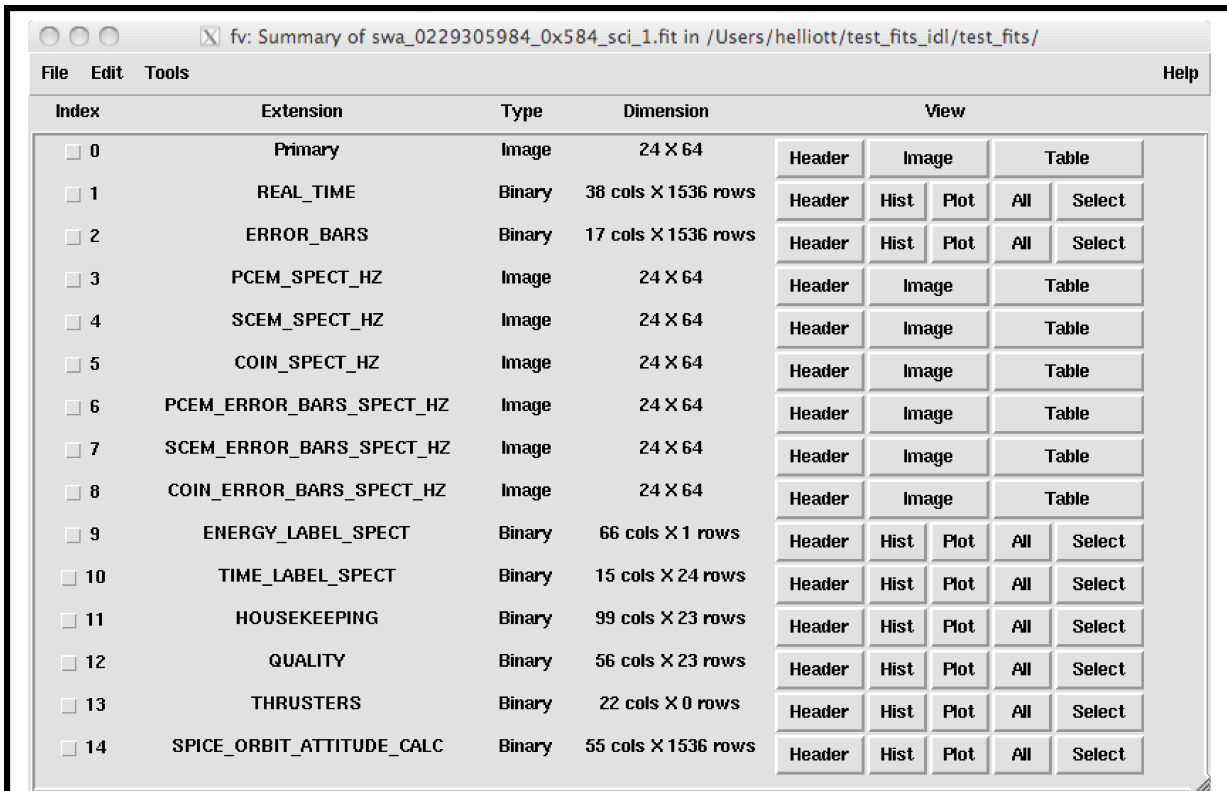

Figure 14-7: Picture of what the real-time calibrated (level 3) files look like using Fv. The numbers listed under index are the extension numbers. All tables are Binary type and all images are image type.

14.5.2 Further Algorithm details for Pipeline

In this section we describe the algorithm for SWAP level 3 (calibrated) processing. As mentioned above, the first step in our processing is to convert all raw values over to engineering units. These conversion factors are also stored in the command and telemetry spreadsheets used in the APL GSEOS system. The details of the housekeeping processing are not discussed further since processing of the housekeeping data consists of simple conversion factors. Analysis of ground calibration data provides critical information used to process the SWAP data, and is consequently a crucial input to our software. A description of the type of calibration information used in the pipeline is given in the calibration document.

14.5.3 Real-time science data processing

The identifier in the SOC filenames for real-time data is the packet ApID (Application Process Identifier; also Application ID) 0x584. Our real-time high voltage science (HVSCI) analysis begins by determining the count rates in Hz as a function of energy for each measurement. A spectrogram is created by sorting the data into sweeps to build a 2-D array where the y-axis is energy per charge and the x-axis is time. A spectrogram spans the time range in HVSCI mode in a given daily level 2 (raw) file. Spectrograms are created for each of the 3 count signals (PCEM, SCEM, and coincidence). Corresponding count rate error spectrograms are created based on counting statistics for each of the three signals as described in the next paragraph. The x-axis time information is provided in the TIME_LABEL_SPECT extension along with a column indicating if a background has been removed. The background is mentioned in section 14.5.10 and described in detail in the calibration document. Also in the TIME_LABEL_SPECT extension is a column indicating the plan and sweep used since the energy bins are different for different plans and sweeps. The y-axis energy labels for a given sweep and plan number are provided in the ENERGY_LABEL_SPECT extension. These count rate spectrograms provide a way to examine our data

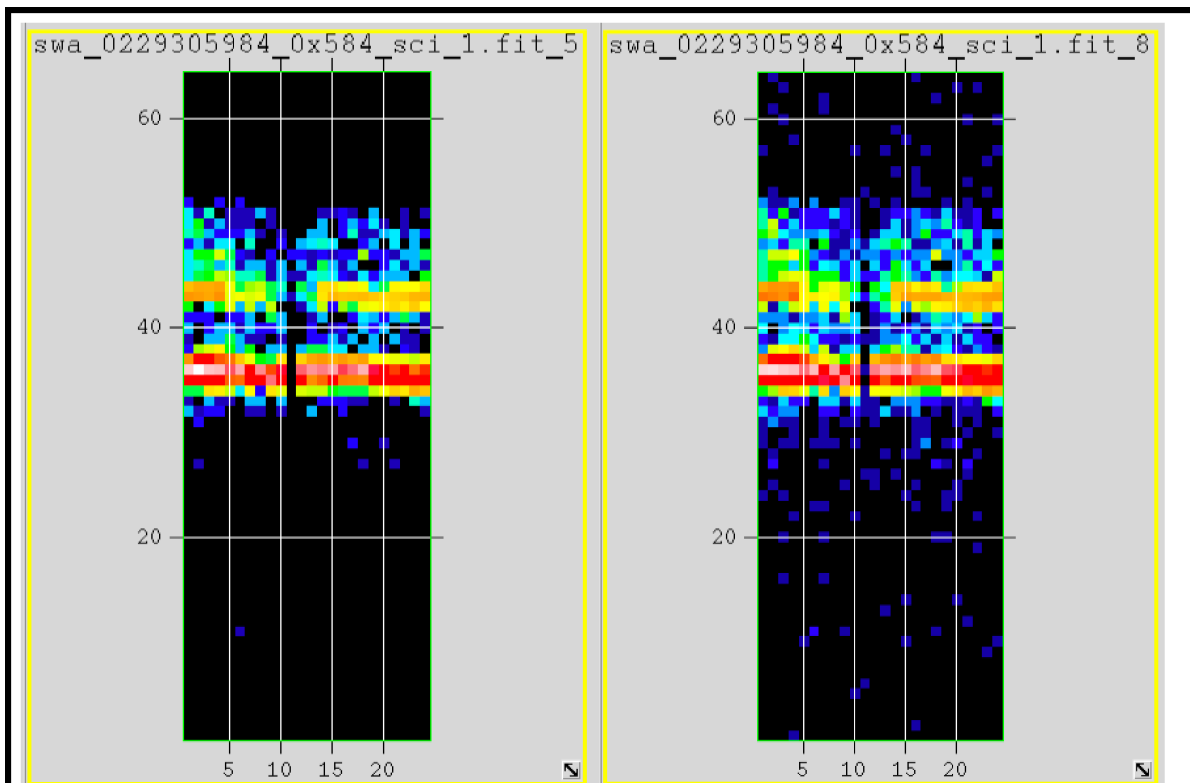

Figure 14-8: Examples of a coincidence (right) and error coincidence (left) spectrogram arrays.

at high time resolution over the full energy range of the instrument. These kinds of spectrograms have proven useful for analyzing high time resolution plasma in situ measurements. Having a high time resolution product is critical for identifying plasma boundaries and shocks. In Figure 14-8 we show examples of what coincidence and an error coincidence spectrogram arrays look like when opened in FV.

14.5.4 Errors

In the level 3 (calibrated) data files an error value for every measurement is given in the extension labeled ERROR_BARS. We also provide spectrogram arrays for each signal type for the errors in the extensions labeled X_ERROR_BARS_SPECT_HZ where X is PCEM, SCEM, or COIN. The errors provided are errors for the rates. The errors include an error for the sample time, and data compression when compression occurs. The raw rates (count counts per sample (C)) are converted to Hz using the 0.390 sec sample/accumulation time (t) (Equation 1). The error squared is given in Equations 2 and 3, and the fractional error squared is shown Equation 4. Taking the square root the resulting fractional error is given by equation 5. The final error given in the data files is shown in Equation 6. If the count rates are not compressed (C_{un}) then $C = C_{un}$ and $\Delta C = \sqrt{C_{un}}$. However, if the counts are compressed (C_{comp}) then $C = 16C_{comp} + 7.5$ and $\Delta C = \sqrt{(16C_{comp} + 7.5)}$. In the ERROR table there is a column indicating if a background has been removed. The background is described in mentioned in section 14.5.10 and described in detail in the calibration document.

$$R_c = \frac{C}{t} \quad (\text{Equation 1})$$

$$(\Delta R_c)^2 = \left(\frac{\partial R_c}{\partial t} \right)^2 (\Delta t)^2 + \left(\frac{\partial R_c}{\partial C} \right)^2 (\Delta C)^2 \quad (\text{Equation 2})$$

$$(\Delta R_c)^2 = \frac{C^2}{t^4} (\Delta t)^2 + \left(\frac{1}{t} \right)^2 (\Delta C)^2 \quad (\text{Equation 3})$$

$$\frac{(\Delta R_c)^2}{R_c^2} = \frac{(\Delta t)^2}{t^2} + \frac{(\Delta C)^2}{C^2} \quad (\text{Equation 4})$$

$$\frac{\Delta R_c}{R_c} = \sqrt{\frac{(\Delta t)^2}{t^2} + \frac{(\Delta C)^2}{C^2}} \quad (\text{Equation 5})$$

$$\Delta R_c = \left(\sqrt{\frac{(\Delta t)^2}{t^2} + \frac{(\Delta C)^2}{C^2}} \right) R_c \quad (\text{Equation 6})$$

14.5.5 *Quality Flags*

Flags assessing the quality of the data are based on operational housekeeping alarms, but in the future additional ones may need to be added which are based on orbit and attitude, and additional calculations. All current flags are stored in a table extension.

14.5.6 *Thruster Firings*

As mentioned earlier the calibrated (level 3) code reorganizes the thruster data into a table where each column refers to a given thruster name and each row is the start time of the thruster firing. The numbers under each thruster column indicate the duration of the thruster firings. Each thruster column has a title that looks like GC1_A2_FIRING where GC1 indicates it originated in a G&C packet, and FIRE indicates thruster firing. The thruster names are A1, A2, B1, B2, B3, C1, C2, C3, C4, D1, D2, D3, D4, F1, and F2. The value for each thruster firing corresponds to the duration of the thruster firing (0=0msec,1=5msec,2=20msec,3=40msec). In the raw data each row is a major frame, and the columns are minor frames where each minor frame is 40msecs. Thus, there are 25 columns with numbers between 0 and 24. In the level 3 (calibrated) data we calculate the start time of the firings for a given minor frame which means we have already taken the major frame start time and added in the time to the start of the minor frame where the firing occurred ($\text{Start_time} = \text{major_frame_start_time} + 0.040 * (\text{minor_frame_number} + 1)$). The implication of this is that one row in the raw file may result in several rows in the calibrated file if there are multiple thruster firings.

14.5.7 *SPICE Orbit and Attitude Calculations*

Our orbit and attitude calculations are contained in the SPICE_ORBIT_ATTITUDE_CALC extension. We calculate times for each SWAP measurement in the REAL_TIME extension. The MET for the packet is listed along with the UTC, and ET for the start and stop time of each measurement. There are two start times and two stop times one since each packet stores two measurements one in the first half second (labeled with a 0) and one in the second half second (labeled with a 1). In the tail the spacecraft is spinning so we have included the angle in the Xsc-Zsc plane between the Zsc axis and Jupiter's spin axis (north). This angle is 0 deg (90 deg) when Zsc (Xsc) is aligned with the North end of Jupiter's spin axis. These angles are named ANGLE_JSP_XZ in the files and calculations were done for the start, middle, and stop for each observation, since the spacecraft rotates quickly (5RPM). All other parameters are calculated at the middle of each observation. We also calculated the angle between the Ysc and the Sun, Jupiter, and Earth. The label for the angle between Ysc and the Sun for the 1st measurement is called Y_SUN_ANG0_MIDDLE. The distances from the spacecraft to Earth, Jupiter and the Sun are calculated (i.e., SUN_SC_0_MIDDLE). We calculate the angle to the Sun is in the X-Y plane (phi), and the latitude angle from the X-Y plane (theta). Positive phi values are toward the +Xsc axis and negative phi angles are towards the -Xsc axis. Negative theta values are towards the top of the instrument since the -Zsc axis is at the top of the instrument. Note this is the opposite convention used in the calibration chamber. However, the phi angle is analogous to the roll angle in calibration (see calibration Document). We also calculate the position and velocity of the spacecraft in IAU Jupiter Cartesian coordinates. The naming convention is such that the X component of position in IAU Jupiter for the 1st half second measurement is labeled as SC_IAU_JUP_X_0. Likewise the X component of the velocity is SC_IAU_JUP_VX_0. In addition to IAU Jupiter coordinates we calculate the spacecraft position in J2000 Jupiter coordinates the X component for the 1st measurement is labeled as SC_J2000_JUP_X_0. Column name descriptions are given in the header for the SPICE extension as well as the names of the SPICE kernel files used to perform the calculations.

As of January, 2014, these SWAP instrument attitude calculations are only made for the Jupiter reference frame. There is a task in its final stages to formalize similar calculations for the SWAP instrument attitude in heliocentric, heliographic and inertial reference frames, as well as future plans for a Pluto-based reference frame for Pluto Encounter observations. These products will be added to SWAP PDS data sets with future deliveries. In the meantime, the PDS user should note that a table containing spacecraft mission trajectory and PDS label keywords describing the attitude of the spacecraft, both in the J2000 inertial reference frame, are provided.

14.5.8 Summary and Histogram Files

Both the summary (Figure 14-9 top) and histogram (Figure 14-9 bottom) files also have the primary header, and housekeeping, quality, thruster and SPICE orbit attitude extensions the same as in the real-time files. In summary files, the Primary Data Unit (PDU; 0th extension) is empty, and extension 1 contains the summary data table converted to engineering units. In histogram files, the histogram data are stored as images in the 0th and 1st extensions. The 0th extension contains the number of times data were added to each bin, and the 1st extension contains the histogram count rates.

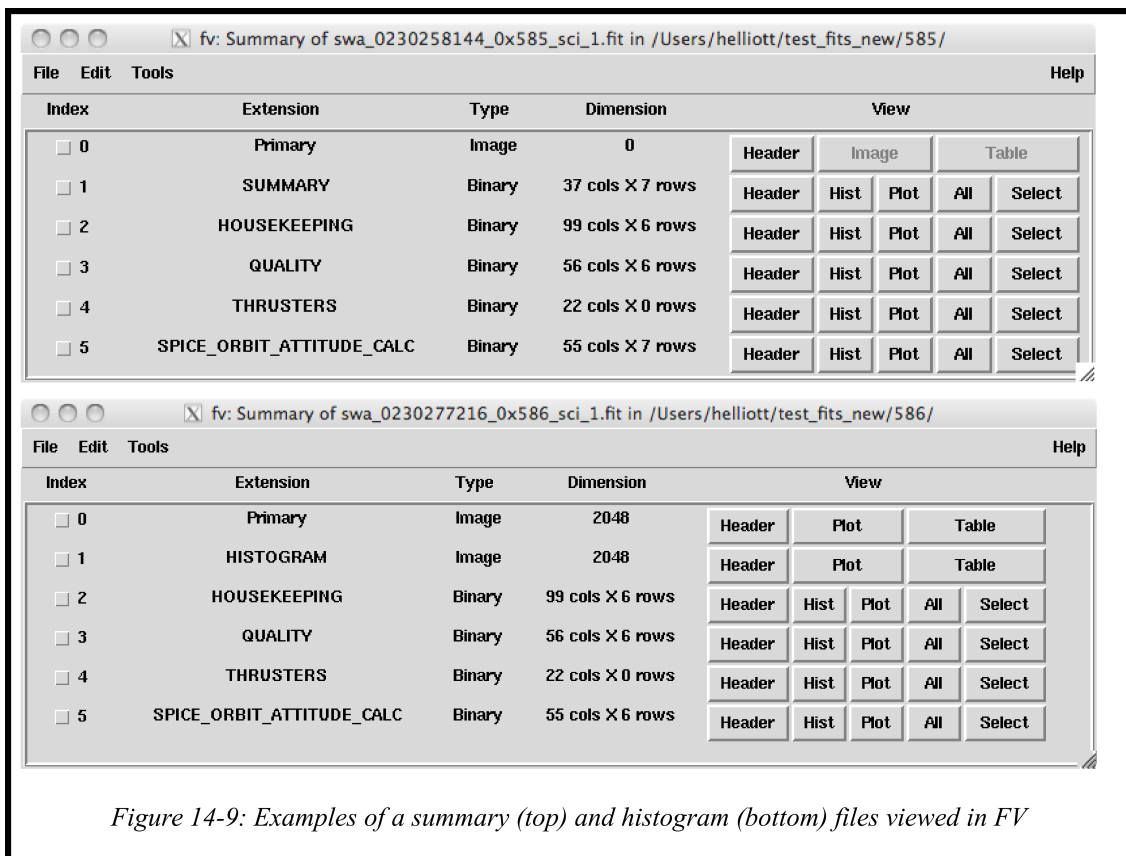

14.5.9 Calibration

Analysis of ground calibration data provides critical information used to process the SWAP data, and is consequently a crucial input to our software; therefore, the use of calibration information in the pipeline is described in a section of the calibration document. The SWAP lab calibration consists of an effective area; an angular response function for the ESA (function of α and ϕ); an energy response curve for the RPA that depends on the RPA and deflector voltages; a function representing how the RPA changes the energy of ions prior to enter the ESA; an energy response function for the ESA; the functions for how the width and center of the ESA passband varies with α ; and a function for how the conversion factor for converting ESA voltage to energy depends on ϕ . Our pipeline incorporates ESA and RPA response curves by precalculating the energy passband for each RPA and ESA voltage pair stored in the onboard tables. This information is used as a lookup table in the pipeline code so that each RPA and ESA voltage step can be assigned a energy per charge value. The code determines which set of tables to use by examining the time range since we have had different sets of RPA and ESA tables loaded at different times in the mission. To determine which of the 4 RPA tables to use the code compares the sweep and plan number in the data to the sweep and plan number in the precalculated tables. The results of the pipeline energy determination are stored in the energy axis label extension and can be used directly to label the y-axis of the spectrogram.

14.5.10 Background Subtraction

There is a background signal (count rate) in our data when the RPA is on. This background decreases as the distance from the Sun increases and will most likely not be a problem for the Pluto encounter. We can

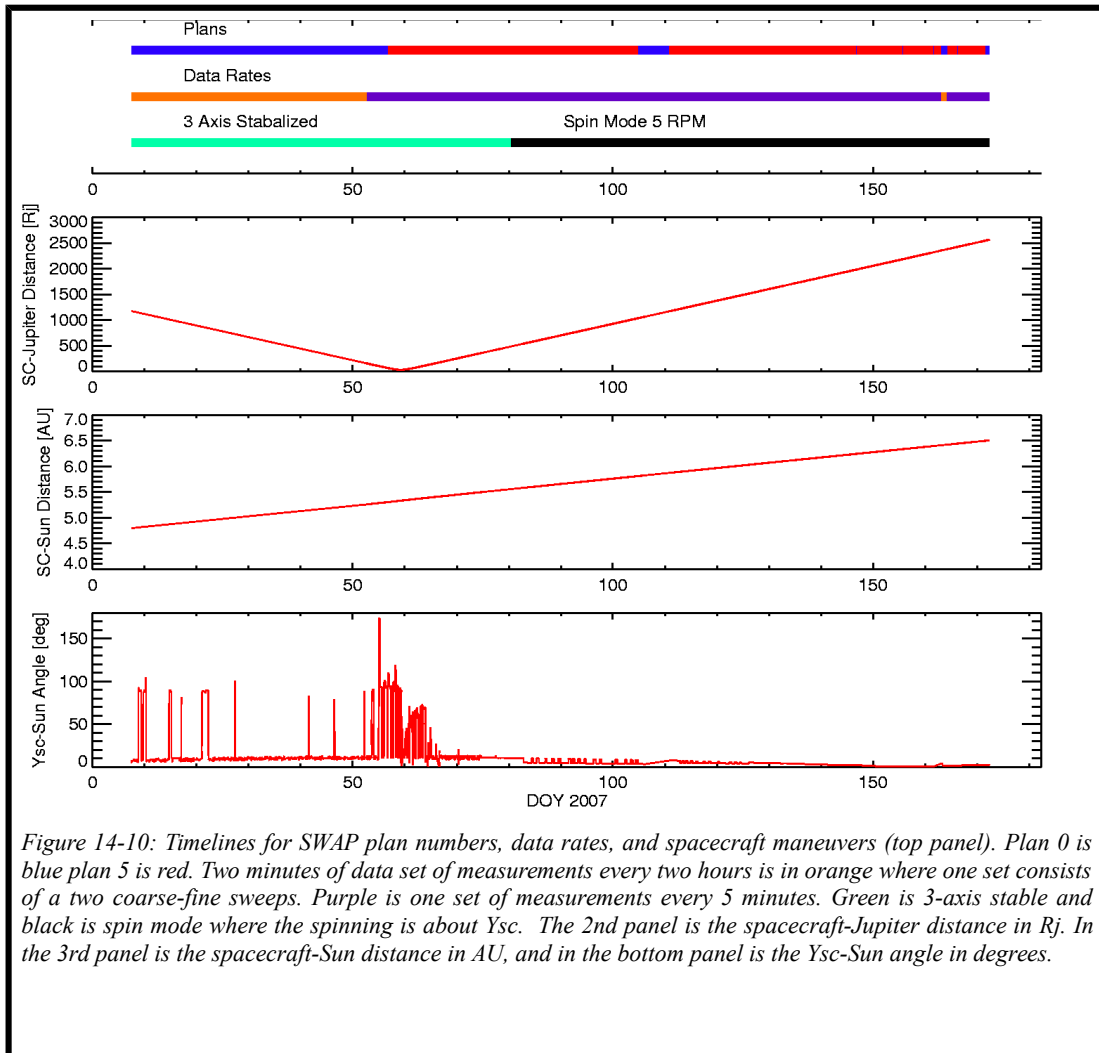

Figure 14-10: Timelines for SWAP plan numbers, data rates, and spacecraft maneuvers (top panel). Plan 0 is blue plan 5 is red. Two minutes of data set of measurements every two hours is in orange where one set consists of a two coarse-fine sweeps. Purple is one set of measurements every 5 minutes. Green is 3-axis stable and black is spin mode where the spinning is about Ysc. The 2nd panel is the spacecraft-Jupiter distance in Rj. In the 3rd panel is the spacecraft-Sun distance in AU, and in the bottom panel is the Ysc-Sun angle in degrees.

operate using only the ESA and have done so for the Jupiter encounter (plan 5). For the solar wind measurements inbound we needed to use the RPA (plan 0) to shield the instrument from high solar wind fluxes. Background subtraction information is processed in a way similar to the energy bin information. A given background subtraction, provided in a calibration file, is only valid for a given time range; therefore, a list of background files with valid application times for each are read in and used to select and read the applicable background, and then the background is subtracted. The background files are stored in the calibration directory and the names of the files used are stored in the list file. The instrument detector gain will evolve with time and this information will be incorporated in fashion similar to the background subtraction. Gain calibrations occur during annual checkouts. The background subtraction is described in more detail in the calibration document.

14.6 Operations

14.6.1 Commissioning

Plan 3 was used to take the first complete sweeps of the solar wind in sequence SWAP-009-6 during commissioning.

14.6.2 Jupiter

The voltage tables were updated before the Jupiter mission phase to improve the voltage sweeps for the Jupiter encounter. There were only two plans used in the Jupiter phase: plan 0 and plan 5. Plan 0 is designed for solar wind and plan 5 is designed for magnetosphere. The voltage settings in plan 0 protect the instrument from high solar wind proton fluxes. Early on the data rate was two coarse-fine scans taken approximately every two hours; the exact timing was adjusted so as not to interfere with other instruments. At 2/21/2007 17:27:31 we kept the plan number set at 0 and changed the sampling rate to 1 coarse and 1 fine scan every 5 minutes. Then at 02/25/2007 19:22:43 we switched to plan 5, which consists of two coarse scans in 64 seconds every 5 minutes. In plan 5 the RPA is off and only the ESA voltage is swept. If the instrument encountered high proton fluxes in the solar wind with the RPA off, the energy passband is large enough that high count rates could cause the instrument to shut down via autonomy rules. Therefore, we took some plan 0 measurement in the magnetosphere to ensure that some measurements would be obtained even if the spacecraft did encounter solar wind. We show timelines for operations in Figure 14-10 along with the distance to Jupiter and the Sun. And in the bottom panel we show the angle between Ysc and the Sun. In spin mode the spacecraft spins about Ysc. The spacecraft entered the magnetosphere on day 056(02/25) in 2007 and the first time it exited in the tail was approximately on day 132 (05/12) of 2007. There were many tail crossings and there appears to be a boundary layer inside the sheath; therefore, definitive boundary crossing times are difficult to determine. When SWAP turned off on day 168 (06/17) of 2007 for hibernation, New Horizons was once again in the magnetosphere.

14.6.3 Pluto Cruise

Per the original mission plan for cruise operations, the SWAP instrument was off for the first 460+ days of Pluto Cruise. After that the operations were sporadic (just a few days in 2009) and mostly Science, alternating with Channel Electron Multiplier gain tests during Annual CheckOuts. After extensive testing in early 2012, in July of that year the project approved daily science operations for the SWAP and PEPSSI instruments throughout the rest of the cruise to Pluto.

14.7 Observation Examples

In this section we show several examples of SWAP data. Figure 14-11 shows the solar wind measurements on approach to Jupiter, and all of the Jupiter magnetosphere and sheath observations. The format is that of a color-coded spectrogram of the background-subtracted coincidence count rates in Hz of solar wind ions as a function energy per charge (E/q) as measured by the Solar Wind Around Pluto (SWAP) instrument on New Horizons at ~ 4.9 AU from the Sun (~ 0.4 AU upstream from Jupiter). We used plan 0 for these measurements since this plan helps protect the instrument from high fluxes by reducing the overall energy passband. In plan 0 the RPA is on at energies below 2000 eV/q. The RPA creates a background and this background has been removed (see calibration document). The lower trace shows the solar wind protons, while the upper trace shows the alpha particles (He^{++}), with enhanced sensitivity ($\sim 100\times$ larger) above 2 keV/q. Solar wind speed is a function E/q , with 1 keV protons

corresponding to typical, ~440 km/s solar wind and larger (smaller) E/q representing faster (slower) wind speeds. Interplanetary shocks passed over the New Horizons spacecraft at ~18:00 on Day-of-Year (DOY) 11 and at ~1300 on DOY 14 causing the abrupt jumps in solar wind speed; the speed immediately following the latter shock was in excess of 600 km/s. The slowly decreasing speed after the second shock (falling E/q of the proton and alpha beams) is a rarefaction region, which forms as faster solar wind outruns the slower solar wind behind. In all, these SWAP observations show a clear solar wind stream structure.

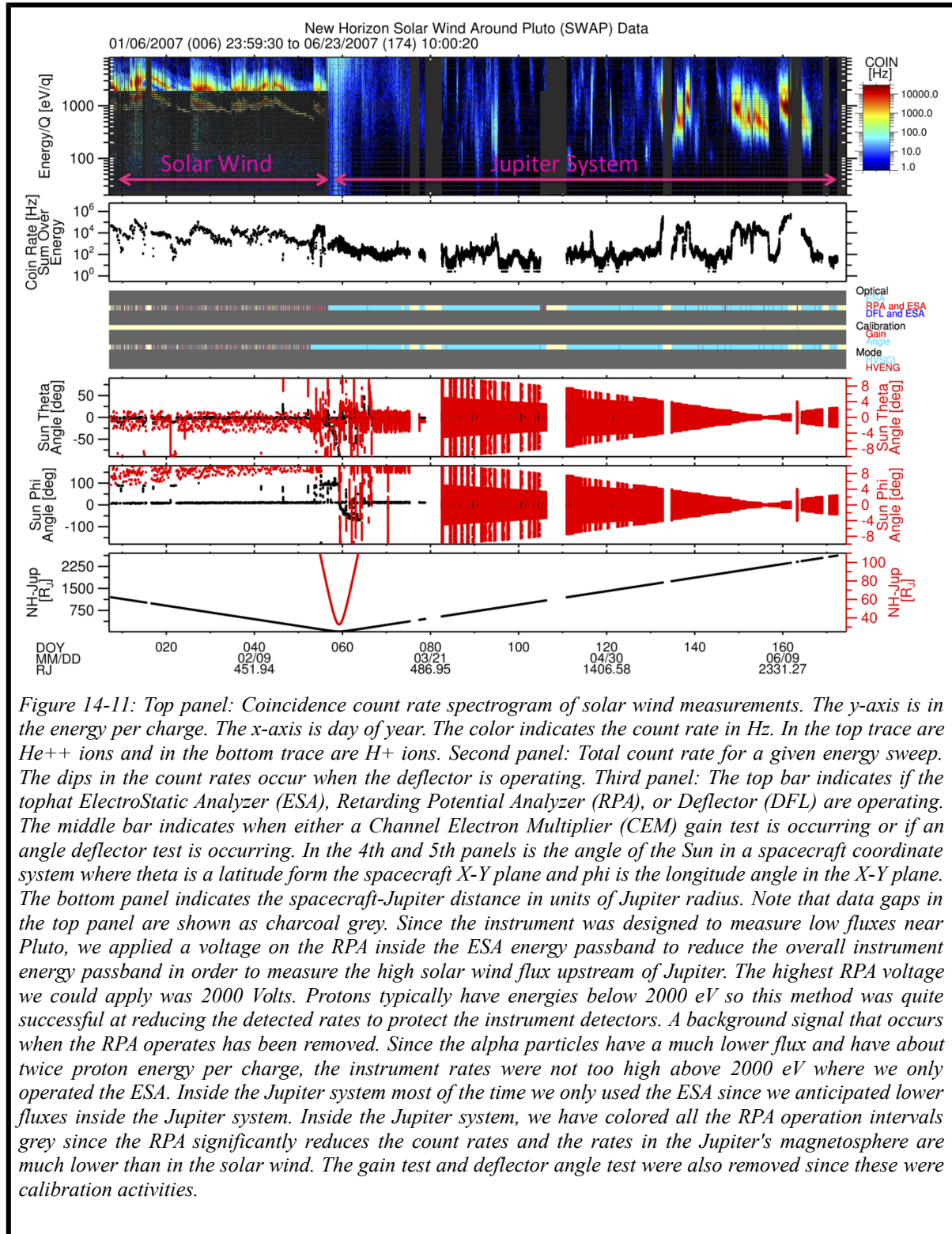

Most of the magnetospheric observations were taken using plan 5 since the plan 5 energy passband is wider and the flux rates are lower in the magnetosphere than in the solar wind (Figure 14-11). The only time the plan 5 data has any background is when there is penetrating radiation, and we do not remove background due to penetrating radiation. The penetrating radiation occurs close to Jupiter and usually is greatest in the secondary and primary signals. When it occurs, the count rates are usually elevated at all energy steps; therefore, in spectrograms the penetrating radiation usually shows up as vertical stripes. The penetrating radiation is significantly reduced in the coincidence signal. The plan 5 data consists of one measurement set every 5th SWAP minute, and one set consists of 2 coarse scans performed in 64 seconds.

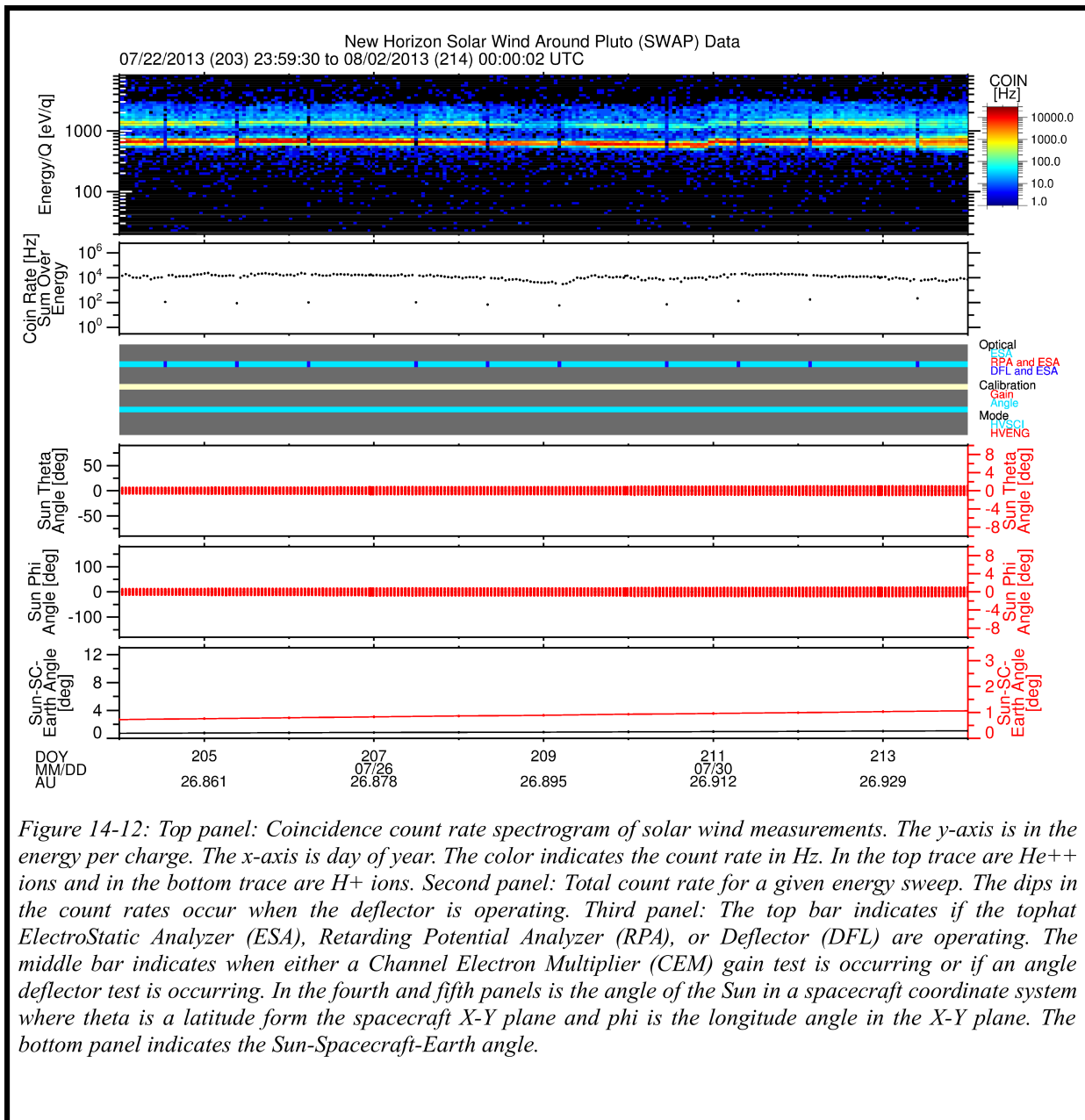

Figure 14-12: Top panel: Coincidence count rate spectrogram of solar wind measurements. The y-axis is in the energy per charge. The x-axis is day of year. The color indicates the count rate in Hz. In the top trace are He⁺⁺ ions and in the bottom trace are H⁺ ions. Second panel: Total count rate for a given energy sweep. The dips in the count rates occur when the deflector is operating. Third panel: The top bar indicates if the top hat ElectroStatic Analyzer (ESA), Retarding Potential Analyzer (RPA), or Deflector (DFL) are operating. The middle bar indicates when either a Channel Electron Multiplier (CEM) gain test is occurring or if an angle deflector test is occurring. In the fourth and fifth panels is the angle of the Sun in a spacecraft coordinate system where theta is a latitude form the spacecraft X-Y plane and phi is the longitude angle in the X-Y plane. The bottom panel indicates the Sun-Spacecraft-Earth angle.

In Figure 14-12 we show a recent example of solar wind measurements taken during the 2013 Annual Checkout (ACO). The data format is similar to the previous figure expect now the Sun-spacecraft-Earth angle is in the bottom panel. Dips in the count rate occur when the SWAP instrument deflector (DFL) is turned on. The deflector intervals are denoted by dark blue in the top bar of the 3rd panel. The main species in the solar wind are protons (H^+) and alpha particles (He^{++}). In the spectrogram (top panel), the peak with the highest count rate is the solar wind proton (H^+) peak, and the alpha particle peak (He^{++}) has energy per charge twice that of the proton peak. Therefore, the 2nd brightest peak in yellow and green is the alpha particle (He^{++}) peak. The blue band above alphas is the interstellar proton pickup ions. The cutoff for these ions occurs at 4 time the energy per charge of the proton peak.

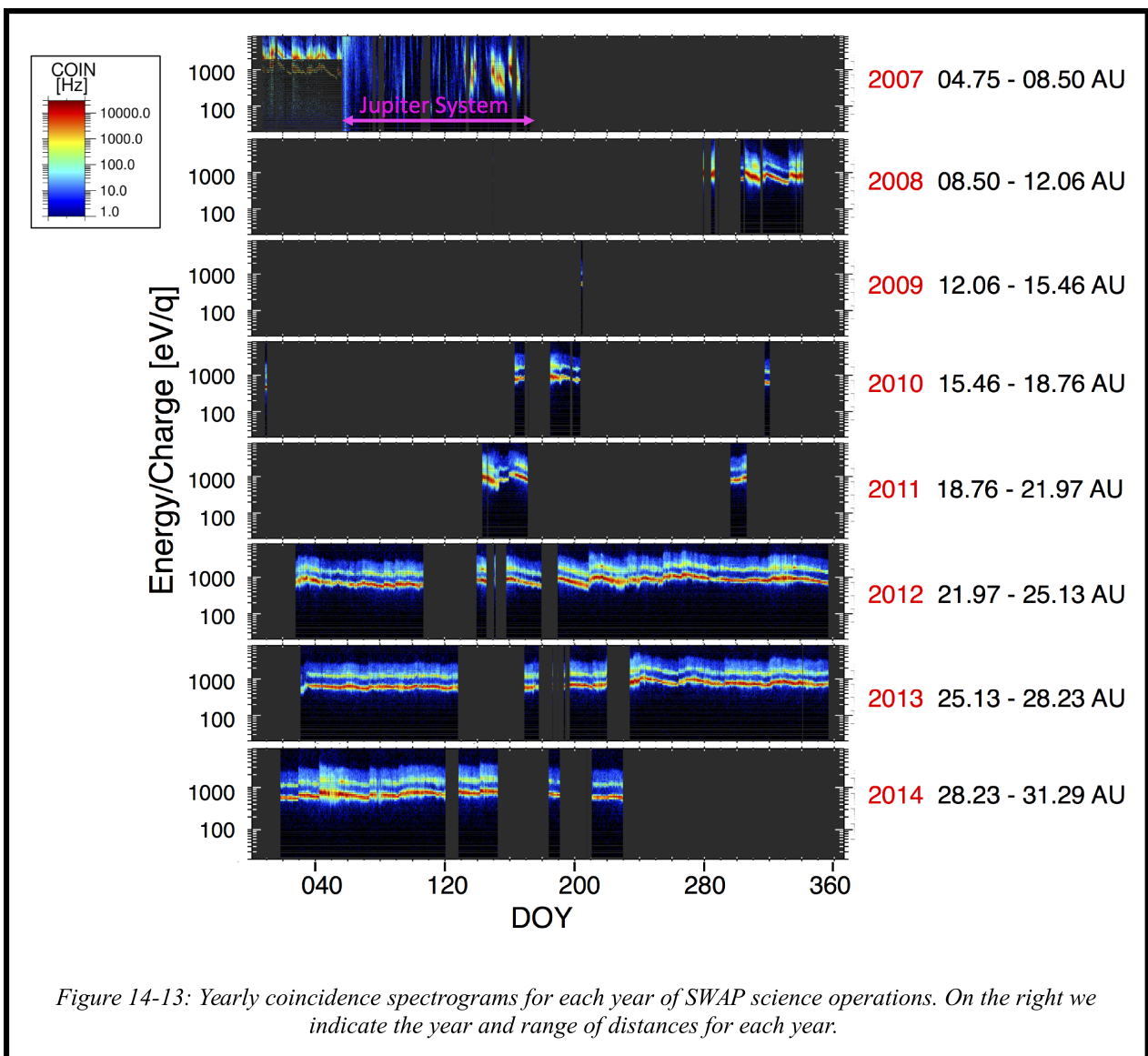

Figure 14-13: Yearly coincidence spectrograms for each year of SWAP science operations. On the right we indicate the year and range of distances for each year.

To help users know when SWAP was collecting observations, in Figure 14-13 we show an overview of all the SWAP science measurements for the entire New Horizons mission to date. Note that starting in 2012

the coverage increases since we began taking measurements during hibernation. In the heliospheric measurements there are times when the solar wind is outside the SWAP FOV. Since the solar wind is quite radial, the Sun location can be used to find the approximate solar wind direction. The Sun direction is given in spacecraft coordinates in the SPICE extension. The Sun location is given as a latitude (theta) and longitude (phi). The names of the parameters THETA_SUN_SC_0, THETA_SUN_SC_1, PHI_SUN_SC_0, PHI_SUN_SC_1 where the "0" and "1" refer to the first and second measurement in a given packet. There for each count rate measurement in the REAL_TIME extension there is a corresponding set of theta and phi angle values in the SPICE extension. The SWAP FOV spans from -10 to +10 degrees in theta and from -138 to +138 degrees in phi.

14.8 Updates to the Level 3 Calibrated SWAP Data Pipeline

In 2007 we added the center energy for given RPA and ESA voltages to the REAL_TIME data extension. The column names are ENERGY_0 and ENERGY_1 in eV and correspond to the 1st and 2nd measurement in a given packet (row). We corrected the background subtraction. We corrected a rounding error in the time used to calculate the spin angles in the SPICE extension and fixed a small offset in the times for the spectrogram in the TIME_LABEL_SPECT extension.

In 2012 and 2013 the SWAP level 3 calibrated data pipeline was rewritten in IDL. The original code was written in C and had some memory overwrite issues that proved difficult to solve. The code was rewritten into IDL since it is easier to avoid memory overwrite issues in IDL. The old files were compared against the new files by examining differences between the old and new values for all the quantities in all the extensions. All the differences were flagged and each difference was addressed. When a problem was found with the new files, the problems were resolved. We found many issues with old files and have made many corrections. We documented the differences that remain which are corrections. The some small errors in the time calculations were fixed and this also affected some of the angle calculations. Many of the comment fields were updated. A few typos in parameter names were fixed. We provide a pdf file of a power point presentation with a summary of the changes and corrections (SWAP_level2_C_IDL_10152012.pdf).

14.9 Gain and Deflector Angle Sweep Tests

After October 28, 2008 the Channel Electron Multiplier (CEM)_detector gain tests are performed using plan 2 and the only plan 2 data after that date occurs during a gain test. Error: Reference source not found shows the start and stop times for the gain tests and the angle test prior to this date.

Type of Test	Start Date and Time	Stop Date and Time
CEM Gain Test	2007-06-04T17:12:34.41	2007-06-04T18:54:58.41
Deflector Angle Sweep Test	2007-06-12T05:30:42.51	2007-06-12T10:23:18.41
CEM Gain Test	2008-09-28T10:06:58.62	2008-09-28T11:36:34.62
CEM Gain Test	2008-10-27T04:07:30.63	2008-10-27T05:38:09.63

Table 14-1: Start and stop times for gain tests and angle test prior to 2008-10-28.

14.10 SWAP Science Goals

These level 3 (calibrated) data products described above will allow us to meet two key science goals as outlined in section 6.3.1.1 of the SWAP Specification document (Document No. 05310-03-SWAPSPEC-01). Below we quote this section.

The Mission Science Requirements document specifies that SWAP should make the following measurements.

- Measure solar wind standoff to ~ 3000 km.
- Determine nature of solar wind interaction at Pluto. Distinguish between magnetic, cometary, & ionospheric interactions.

14.10.1 Dataflow Block Diagram

Figure 14-14 provides a summary of the inputs (in gold and violet) and steps (in blue) in the calibration pipeline which convert the raw data to scientific units.

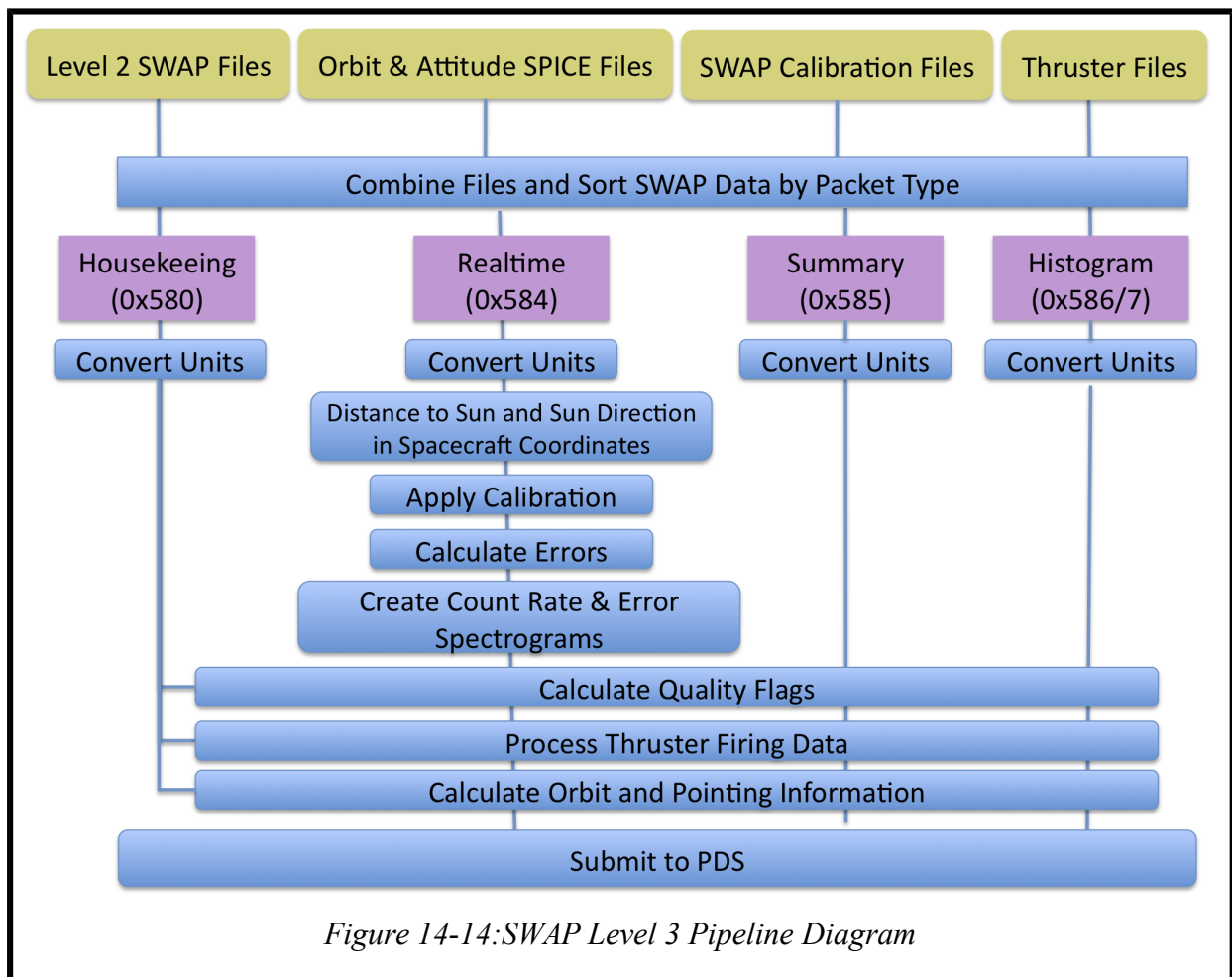

Figure 14-14: SWAP Level 3 Pipeline Diagram

14.10.2 *Extra FITS Extensions and Their Definitions*

We have binary tables for both real-time, and summary data. Likewise, we have binary table extensions for housekeeping data, flags, errors, and thruster packet spacecraft data. We have image extensions for both count rate spectrograms and error spectrograms image. For histogram data we have two image extensions: one for counts and one for accumulations (number of samples).

14.10.3 *Scientific Units*

14.10.4 *Additional FITS and PDS Keywords Added*

The level 3 calibrated code has rate spectrogram in Hz, and all the engineering data converted to engineering units.

14.10.5 *Hardware/OS Development Platform*

Intel, Linux

14.10.6 *Language(s) Used*

IDL

14.10.7 *Third Party Libraries Required*

SPICE and FITS.

14.10.8 *Memory Required*

14.10.9 *Temporary File System Space Needed*

None

14.10.10 *Predicted Size of Output File(s)*

14.10.11 *Predicted Execution time*

On the order of seconds

14.10.12 *Contact/Support Person(s)*

PI: Dave McComas

Lead Engineer and Project Manager: Scott Weidner

Onboard Software and Commanding: John Hanley

Pipeline and Science Operations: Heather Elliott

Sequencing: Helen Hart

14.10.13 Maintenance Schedule (Code/Data Updates, Documentation)

14.11 SWAP Publications To Date

- Ebert, R. W., D. J. McComas, B. Rodriguez, P. Valek, and S. Weidner, A composition analysis tool for the Solar Wind Around Pluto (SWAP) instrument on New Horizons, *Space Sci. Rev.*, doi: 10.1007/s11214-010-9683-6, 156, 1-12, 2010.
- Ebert, R. W., D. J. McComas, F. Bagenal, and H. A. Elliott, Location, structure, and motion of Jupiter's dusk magnetospheric boundary from ~1625 to 2550 RJ, *J. Geophys. Res.*, 115, A12223, doi: 10.1029/2010JA015938, 2010.
- McComas, D. J. and F. Bagenal, Jupiter: A fundamentally different magnetospheric interaction with the solar wind, *Geophys. Res. Lett.*, 34, L20106, doi:10.1029/2007GL031078, 2007.
- McComas, D.J., F. Allegrini, F. Bagenal, F. Crary, R. W. Ebert, H. Elliott, A. Stern, and P. Valek, Diverse Plasma Populations and Structures in Jupiter's Magnetotail, *Science*, 318, doi: 10.1126/science.1147393, 217-220, 2007.
- McComas, D. J., F. Allegrini, F. Bagenal, P. Casey, P. Delamere, D. Demkee, G. Dunn, H. Elliott, J. Hanley, K. Johnson, J. Langle, G. Miller, S. Pope, M. Reno, B. Rodriguez, N. Schwadron, P. Valek, and S. Weidner, The Solar Wind Around Pluto (SWAP) instrument aboard New Horizons, *Space Sci. Rev.*, doi: 10.1007/s11214-007-9205-3, 140, 261-313, 2008.
- McComas, D. J. and F. Bagenal, Re: Jupiter: A fundamentally different magnetospheric interaction with the solar wind, *Response to Comment, Geophys. Res. Lett.*, 35, L10103, doi:10.1029/2008GL034351, 2008.
- McComas, D. J., H. A. Elliott, and N. A. Schwadron, Pickup hydrogen distributions in the solar wind at ~11 AU: Do we understand pickup ions in the outer heliosphere?, *J. Geophys. Res.*, 115, A03102, doi: 10.1029/2009JA014604, 2010.
- Nicolaou, G., D. J. McComas, F. Bagenal, and H.A. Elliott, Fluid properties of plasma ions in the distant Jovian magnetosheath using Solar Wind Around Pluto (SWAP) data on New Horizons, submitted to *J. Geophys. Res.*, SUBMITTED, 2013.
- Randol, B. M., R. W. Ebert, F. Allegrini, D. J. McComas, and N. A. Schwadron, Reflections of ions in electrostatic analyzers: A case study with New Horizons/Solar Wind Around Pluto, *Rev. Sci. Instrum.*, 81, 114501, 2010.
- Randol, B. M. and D. J. McComas, Density correlations between solar wind and pick-up ions, *Pickup Ions throughout the Heliosphere and Beyond: Proceedings of the 9th Annual International Astrophysics Conference, AIP CP1302*, pp. 64-69, 2010.
- Randol, B. M., H. A. Elliott, J. T. Gosling, D. J. McComas, and N. A. Schwadron, Observations of isotropic interstellar pick-up ions at 11 and 17 AU from New Horizons, *Astrophys. J.*, 755:75, doi:10.1088/0004-637X/755/1/75, 2012.
- Randol, B. M., D. J. McComas, and N. A. Schwadron, Interstellar pick-up ions observed between 11 and 22 AU by New Horizons, *Astrophys. J.*, 768:120, doi:10.1088/0004-637X/768/2/120, 2013.
- Young, L. A., S. A. Stern, H. A. Weaver, F. Bagenal, R. P. Binzel, B. Buratti, A. F. Cheng, D. Cruikshank, G. R. Gladstone, W. M. Grundy, D. P. Hinson, M. Horanyi, D. E. Jennings, I. R. Linscott, D. J. McComas, W. B. McKinnon, R. McNutt, J. M. Moore, S. Murchie, C. B. Olkin, C. C. Porco, H. Reitsema, D. C. Reuter, J. R. Spencer, D. C. Slater, D. Strobel, M. E. Summers, and G. L. Tyler, New

Horizons: Anticipated scientific investigations at the Pluto system, Space Sci. Rev., doi: 10.1007/s11214-008-9462-9, 140, 93-127, 2008.

14.12 Packet Description

This section gives the parameters found in SWAP science packets. The names are as given in the APL spreadsheets used to view the data in real-time and playback modes. The level 1 names are shortened versions of these names.

REAL_TIME

SWAP_RT.CC_PID_VER	Primary Header - Version Number
SWAP_RT.CC_PID_TYPE	Primary Header - Packet Type
SWAP_RT.CC_PID_SEC_FLAG	Primary Header - Secondary Header Flag
SWAP_RT.CC_PID_APID	Primary Header - Application ID; type of data i.e. real-time, housekeeping, etc
SWAP_RT.CC_PSC_GRP_FLAG	Primary Header - Grouping Flag; set to a constant value, not used
SWAP_RT.CC_PSC_SSC	Primary Header - Sequence Count
SWAP_RT.CC_PKT_DATA_LN	Primary Header - Packet Length; this is used to
SWAP_RT.CC_MET_TIME	Secondary Header - Time
SWAP_RT.SEC64_ST	A bit indicating the beginning of a 64-second cycle
SWAP_RT.PLAN_ID	Plan ID
SWAP_RT.SWEEP_ID	Sweep ID
SWAP_RT.ANGLE	Commanded angle for deflection compensation
SWAP_RT.RPA_LVL0	RPA level during first half-second
SWAP_RT.DFL_LVL0	DFL level during first half-second
SWAP_RT.ESA_LVL0	ESA level during first half-second
SWAP_RT.RPA_LVL1	RPA level during first half-second
SWAP_RT.DFL_LVL1	DFL level during first half-second
SWAP_RT.ESA_LVL1	ESA level during first half-second
SWAP_RT.MODE	Enumerated type representing each of the modes
SWAP_RT.PCEM_RNG_ST0	PCEM counts are compressed or raw during first half-second; this is a flag that determines if the data in SWAP_RT.PCEM_CNT0 is compressed or not. If this flag is set to zero the data are not compressed. If the flag is set to 1 then the data in SWAP_RT.PCEM_CNT0 is 1/16 of the actual count rate.
SWAP_RT.SCEM_RNG_ST0	SCEM counts are compressed or raw during first half-second
SWAP_RT.COIN_RNG_ST0	Coincidence counts are compressed or raw during first half-second
SWAP_RT.PCEM_RNG_ST1	PCEM counts are compressed or raw during second half-second
SWAP_RT.SCEM_RNG_ST1	SCEM counts are compressed or raw during second half-second
SWAP_RT.COIN_RNG_ST1	Coincidence counts are compressed or raw during second half-second
SWAP_RT.PCEM_CNT0	PCEM count value during first half-second

SWAP_RT.SCEM_CNT0	SCEM count value during first half-second
SWAP_RT.COIN_CNT0	Coincidence count value during first half-second
SWAP_RT.PCEM_CNT1	PCEM count value during second half-second
SWAP_RT.SCEM_CNT1	SCEM count value during second half-second
SWAP_RT.COIN_CNT1	Coincidence count value during second half-second
SWAP_RT.CHKSUM	XOR checksum; this value is based on all the other real-time quantities listed above. It is used to determine if a bit was flipped in one of the real-time quantities. If check sum is not what is predicted based on the other real-time quantities then the data need to be thrown away.

SUMMARY

SWAP_SM.CC_PID_VER	Primary Header - Version Number
SWAP_SM.CC_PID_TYPE	Primary Header - Packet Type
SWAP_SM.CC_PID_SEC_FLAG	Primary Header - Secondary Header Flag
SWAP_SM.CC_PID_APID	Primary Header - Application ID
SWAP_SM.CC_PSC_GRP_FLAG	Primary Header - Grouping Flag
SWAP_SM.CC_PSC_SSC	Primary Header - Sequence Count
SWAP_SM.CC_PKT_DATA_LN	Primary Header - Packet Length
SWAP_SM.CC_MET_TIME	Secondary Header - Time
SWAP_SM.BEG_TIME	Time stamp at the beginning of this summary period
SWAP_SM.END_TIME	The time stamp at the end of this summary period
SWAP_SM.N64_CNT	Number of 64-second sample sets used
SWAP_SM.NDFL	DFL
SWAP_SM.ANGLE_SUM	Angle
SWAP_SM.DENSITY_SUM	An estimate of the pseudo density
SWAP_SM.VELOCITY_SUM	An estimate of the pseudo speed using energy
SWAP_SM.TEMP_SUM	Estimate of the pseudo temperature
SWAP_SM.ANGLE_SSQ_HI	The variance of the angles
SWAP_SM.ANGLE_SSQ_LO	The variance of the angles
SWAP_SM.DENSITY_SSQ_HI	The variance of the pseudo n-values
SWAP_SM.DENSITY_SSQ_LO	The variance of the pseudo n-values
SWAP_SM.VELOCITY_SSQ_HI	The variance of the pseudo V-values
SWAP_SM.VELOCITY_SSQ_LO	The variance of the pseudo V-values
SWAP_SM.TEMP_SSQ_HI	The variance of the pseudo T-values
SWAP_SM.TEMP_SSQ_LO	The variance of the pseudo T-values
SWAP_SM.ANGLE_MIN	Minimum Angle
SWAP_SM.DENSITY_MIN	Minimum pseudo density
SWAP_SM.VELOCITY_MIN	Minimum pseudo speed
SWAP_SM.TEMP_MIN	Minimum pseudo Temperature
SWAP_SM.ANGLE_MAX	Maximum Angle
SWAP_SM.DENSITY_MAX	Maximum pseudo density
SWAP_SM.VELOCITY_MAX	Maximum pseudo speed
SWAP_SM.TEMP_MAX	Maximum pseudo temperature
SWAP_SM.CHKSUM	XOR checksum

HISTOGRAM Type 1

SWAP_H0.CC_PKT_DATA_LN	Primary Header - Packet Length
SWAP_H0.CC_MET_TIME	Secondary Header - Time
SWAP_H0.BEG_TIME	Time stamp at the beginning of this histogram period
SWAP_H0.END_TIME	The time stamp at the end of this histogram period
SWAP_H0.SMPLS_CNT	Number of 64-second samples used
SWAP_H0.PLAN_ID	The Plan ID used for the current science sweeping mode
SWAP_H0.TABLE_ID	Table ID within the Plan ID that is being used
SWAP_H0.SEQNUM_CNT	Sequence number starting at 0 for header
SWAP_H0.DATA	Histogram data
SWAP_H0.CHKSUM	XOR checksum

HISTOGRAM Type 2

SWAP_H1.CC_PID_VER	Primary Header - Version Number
SWAP_H1.CC_PID_TYPE	Primary Header - Packet Type
SWAP_H1.CC_PID_SEC_FLAG	Primary Header - Secondary Header Flag
SWAP_H1.CC_PID_APID	Primary Header - Application ID
SWAP_H1.CC_PSC_GRP_FLAG	Primary Header - Grouping Flag
SWAP_H1.CC_PSC_SSC	Primary Header - Sequence Count
SWAP_H1.CC_PKT_DATA_LN	Primary Header - Packet Length
SWAP_H1.CC_MET_TIME	Secondary Header - Time
SWAP_H1.SEQNUM_CNT	Sequence number
SWAP_H1.DATA	Histogram data
SWAP_H1.CHKSUM	XOR checksum starting with beginning of CCSDS header

HOUSEKEEPING

SWAP_HK.CC_PID_VER	Primary Header - Version Number
SWAP_HK.CC_PID_TYPE	Primary Header - Packet Type
SWAP_HK.CC_PID_SEC_FLAG	Primary Header - Secondary Header Flag
SWAP_HK.CC_PID_APID	Primary Header - Application ID
SWAP_HK.CC_PSC_GRP_FLAG	Primary Header - Grouping Flag
SWAP_HK.CC_PSC_SSC	Primary Header - Sequence Count
SWAP_HK.CC_PKT_DATA_LN	Primary Header - Packet Length
SWAP_HK.CC_MET_TIME	Secondary Header - Time
SWAP_HK.CMD_EXE_CNT	Cumulative mod-256 count of successfully executed commands
SWAP_HK.CMD_REJ_CNT	Cumulative mod-256 count of rejected commands
SWAP_HK.LUT_CHOICE	Which LUT is in use
SWAP_HK.PCEM_SAFE	PCEM was safed due to CEM interrupts
SWAP_HK.SCEM_SAFE	SCEM was safed due to CEM interrupts
SWAP_HK.WDT_ST	SWAP has rebooted due to a watchdog expiration.
SWAP_HK.RCV_SAFE_ST	SWAP has received safe command from S/C
SWAP_HK.SAFE_ST	SWAP has safed itself.
SWAP_HK.PCEM_RATE_ST	Count rate threshold for PCEM counter has been exceeded
SWAP_HK.SCEM_RATE_ST	Count rate threshold for the SCEM counter has been exceeded

SWAP_HK.PCEM_CURR_ST	Current threshold for the PCEM has been exceeded
SWAP_HK.SCEM_CURR_ST	Current threshold for the SCEM has been exceeded
SWAP_HK.PCEM_VOLT_ST	Voltage tolerance for the PCEM has been exceeded.
SWAP_HK.SCEM_VOLT_ST	Voltage tolerance for the SCEM has been exceeded.
SWAP_HK.LVPS_VOLT_ST	Voltage tolerance for +5 V or -5V supply has been exceeded.
SWAP_HK.LVPS_CURR_ST	Current tolerance for +5 V or -5V supply has been exceeded.
SWAP_HK.OVR_TEMP_ST	Upper temperature limit exceeded.
SWAP_HK.UND_TEMP_ST	Lower temperature limit exceeded.
SWAP_HK.MODE	Enumerated type representing each of the modes
SWAP_HK.MEMDP_ST	MEMDUMP State
SWAP_HK.SENSOR_TEMP	Temperature of sensor detector. AD mux = 0x10
SWAP_HK.HVSUPP_TEMP	Temperature of HVPS. AD mux = 0x11
SWAP_HK.CNTRLR_TEMP	Temperature of controller. AD mux = 0x12
SWAP_HK.PCEM_VOLT	Voltage monitor of PCEM HVPS. AD mux = 0x02
SWAP_HK.SCEM_VOLT	Voltage monitor of SCEM HVPS. AD mux = 0x03
SWAP_HK.PCEM_CURR	Strip current monitor of PCEM HVPS. AD mux = 0x04
SWAP_HK.SCEM_CURR	Strip current monitor of SCEM HVPS. AD mux = 0x05
SWAP_HK.P5_VOLT	Voltage monitor of +5V power supply. AD mux = 0x0c
SWAP_HK.N5_VOLT	Voltage monitor of -5V power supply. AD mux = 0x0d
SWAP_HK.P5_CURR	Current monitor of +5V power supply. AD mux = 0x0e
SWAP_HK.N5_CURR	Current monitor of -5V power supply. AD mux = 0x0f
SWAP_HK.SWAP_REV	Revision number for the SWAP software
SWAP_HK.LAST_OPCODE	Opcode of last executed command
SWAP_HK.PHD_LLD_LVL	DAC Level of PHD LLD
SWAP_HK.MEMLD_ST	MEMLOAD state
SWAP_HK.OPT1_ST	State of primary optics
SWAP_HK.OPT2_ST	State of backup optics
SWAP_HK.PCEM_ST	State of Primary Channel Electron Multiplier disable/enable
SWAP_HK.SCEM_ST	State of Secondary Channel Electron disable/enable
SWAP_HK.SPARE1	SPARE
SWAP_HK.PCEM_CNT_ST	The PCEM count rate was tripped but handled by SWAPFW
SWAP_HK.SCEM_CNT_ST	The SCEM count rate was tripped but handled by SWAPFW
SWAP_HK.PCEM_CURRTHR	Current level when PCEM safety algos are tripped
SWAP_HK.SCEM_CURRTHR	Current level when SCEM safety algos are tripped
SWAP_HK.PCEM_LVL	PCEM DAC level
SWAP_HK.SCEM_LVL	SCEM DAC level
SWAP_HK.AGND_VOLT	Voltage monitor of Analog ground. A/D mux = 0x00
SWAP_HK.CEM_CURR	Current level when SCEM safety interrupt is tripped
SWAP_HK.ESA1_VOLT	Voltage monitor of ESA HVPS. AD mux = 0x06
SWAP_HK.ESA2_VOLT	Voltage monitor of ESA HVPS. AD mux = 0x07
SWAP_HK.DFL1_VOLT	Voltage monitor of DFL HVPS. AD mux = 0x08
SWAP_HK.DFL2_VOLT	Voltage monitor of DFL HVPS. AD mux = 0x09
SWAP_HK.RPA1_VOLT	Voltage monitor of RPA HVPS. AD mux = 0x0a
SWAP_HK.RPA2_VOLT	Voltage monitor of RPA HVPS. AD mux = 0x0b
SWAP_HK.P2_5_VOLT	Voltage monitor of +2.5V reference. AD mux = 0x13
SWAP_HK.PHD_LLD_VOLT	Voltage monitor of PHD_LLD. Ad mux = 0x14

SWAP_HK.PCEM_RATELIM	The count value at which the primary CEM safety limit is set.
SWAP_HK.SCEM_RATELIM	The count value at which the secondary CEM safety limit is set.
SWAP_HK.STIM_ENA	State of whether the stimulator pulsers are enabled or disabled.
SWAP_HK.PPS_SEL_ST	State of which side of the IEM interface is being used.
SWAP_HK.PPS_DET_ST	1 PPS detected state
SWAP_HK.CEM_INT_LIM	Current limit at which the CEM triggers an interrupt.
SWAP_HK.CMD_ECHO_ST	Whether command echo is enabled or disabled
SWAP_HK.HV_PGSAFE_ST	State of safe / arm plug
SWAP_HK.HV_PGENA_ST	State of high-voltage disable/enable plug
SWAP_HK.HV_ARM_ST	State of high-voltage software disable/enable
SWAP_HK.CEM_INT_DIP	Counts to dip the CEM supplies
SWAP_HK.PLAN_ID	The Plan ID used for the current science sweeping mode if any.
SWAP_HK.SWEEP_ID	Current Sweep table ID
SWAP_HK.ANGLE	The commanded angle for deflection compensation
SWAP_HK.PCEM_VLT1_ST	PCEM voltage is out of tolerance for only one 0.5 second sample
SWAP_HK.PCEM_CUR1_ST	PCEM current is out of tolerance for only one 0.5 second sample
SWAP_HK.SCEM_VLT1_ST	SCEM voltage is out of tolerance for only one 0.5 second sample
SWAP_HK.SCEM_CUR1_ST	SCEM current is out of tolerance for only one 0.5 second sample
SWAP_HK.PCEM_INT_ST	The CEM current interrupt was tripped, but handled by SWAPFW
SWAP_HK.SCEM_INT_ST	The CEM current interrupt was tripped, but handled by SWAPFW
SWAP_HK.EEP2_RDY	EEPROM 2 is ready to be written
SWAP_HK.EEP1_RDY	EEPROM 1 is ready to be written
SWAP_HK.FPGA_TYPE	Type number of the FPGA
SWAP_HK.FPGA_REV	Revision number of the FPGA
SWAP_HK.SM_TLM	How often the science summary packet is output.
SWAP_HK.HX_TLM	How often the histogram telemetry packet is output.
SWAP_HK.RT_TLM	How often all of the 64-second real-time packets are output
SWAP_HK.HK_TLM	How often the housekeeping packet is output.
SWAP_HK.FPGA_PUP_ST	A status of the power on check of the FPGA initialization check
SWAP_HK.EEPL2_CKS_ST	Status of the power on check of the EEP_L2 checksum
SWAP_HK.EEPL1_CKS_ST	Status of the power on check of EEP_L1 checksum
SWAP_HK.RAM_D_ST	Status of the power on check of the RAM_D memory test
SWAP_HK.EEPC2_CKS_ST	Status of the power on check of the EEP_C2 checksum
SWAP_HK.EEPC1_CKS_ST	Status of the power on check of the EEP_C1 checksum
SWAP_HK.RAM_C_ST	Status of the power on check of the RAM_C memory test
SWAP_HK.PROM_CKS_ST	Status of the power on check of the PROM checksum
SWAP_HK.CHKSUM	XOR checksum

15. ACRONYMS AND ABBREVIATIONS

ADC	Analog-to-Digital Converter; converts electrical quantity, typically Volts, to DN or ADU
ADU	Analog-to-Digital Units; same as DN
a.k.a.	Also Known As
ApID	Application (Process) Identifier; 12-bit integer for telemetry packets, usually in hexadecimal
APID	Alternate form of ApID
APL	Alternate form of JHUAPL
bit	Binary Digit; 0 or 1 in base two
BTI	Bad Time Interval (PEPSSI)
C&DH	see CDH
CCD	Charge-Coupled Device (Instrument) or Critical Command Decoder (RF/Telecomm.)
CCSDS	Consultative Committee for Space Data Systems; telemetry packet format specification
CDH	Command and Data Handling; S/C or instrument; typ. redundant, so also CDH1, CDH-2, ...
CODMAC	Committee on Data Management and Computation ; data level definitions within NASA
CSOC	Christy Science Operations Center at MOPs JHU/APL in Laurel, MD
CU	Compression Unit
DN	Data Number; raw value measured by Analog-to-Digital Converter; typically an integer
DOY	Day Of Year (1-366)
EDU	Extension Data Unit; e.g. of FITS file; EDUs follow PDU; EDU numbering starts at 1
PHDU	Extension Header Data Unit – FITS header of Extension Data Unit
ESA	ElectroStatic Analyzer; part of SWAP instrument
FITS	Flexible Image Transport System; data storage format
FPGA	Field Programmable Gate Array
FV	FITS Viewing application; also Fv
G&C	See GNC
GB	GigaByte; 1,000,000,000 bytes
GN&C	See GNC
GNC	Guidance, Navigation, and Control (also sometimes G&C, GN&C)
HVPS	High-Voltage Power Supply
i.e.	Id Est (Latin: “that is”)
ICD	Interface Control Document
IEM	Integrated Electronic Module
IPM	Inter-Planetary Medium
ITF	Instrument Transfer Frame
JHUAPL	Johns Hopkins University/Applied Physics Laboratory; also JHU/APL
kB	kilobyte; 1,000 bytes
KiB	kibibyte; $1,024 = 2^{10}$ bytes
LASP	Laboratory for Atmospheric and Space Physics, University of Colorado Boulder
LSB	Least-Significant Bit/Byte first; ordering of bits or bytes; also lsb, LSByte-first, ...
LVPS	Low-Voltage Power Supply
MB	MegaByte; 1,000,000 bytes
Mbit	MegaBit; 1,000,000 bits
MiB	MebiByte; $1,048,576 = 2^{20}$ bytes
MCP	MicroChannel Plate; detector

MET	Mission Event (or Elapsed) Time; 10-digit, zero-padded, decimal representation of S/C seconds; may have decimal point and fractional suffix
MOPs	Mission Operations; also MOPS
MSB	Most-Significant Bit/Byte first; ordering of bits or bytes; also msb, MSByte-first, ...
N.B.	Nota Bene (Latin: “note well” i.e. pay particular attention to what follows)
NH	New Horizons; may refer to spacecraft, mission or project
OAP	Off-Axis Paraboloidal (mirror)
PDS	Planetary Data System; NASA archive organization for planetary data
PDU	Primary Data Unit; e.g. of FITS file, compare to EDU; sometimes interpreted as (E)DU 0
PHDU	Primary Header Data Unit – FITS header of Primary Data Unit
PERSI	Pluto Exploration Remote Sensing Investigation; sensor suite: MVIC; LEISA; ALICE.
PI	Principal Investigator
PPS	Pulse-Per-Second
Rj	Radius of Jupiter
Rp	Radius of Pluto
Rx	Receive (line; pin-out; channel)
S/C	Spacecraft; also SC, sc (subscript e.g. Ysc)
SOC	Science Operations Center (see also SOCC)
SOCC	Solar Occultation Channel (ALICE instrument; sometimes also SOC)
SSR	Solid-State Recorder; two on-board NH, so also SSR1, SSR-2, ...
STScI	Space Telescope Science Institute
SwRI	Southwest Research Institute; office in Boulder, CO, USA
TDI	Time-Delay Integration
TNF	Tracking and Navigation File
TOD	Time Of Day
TOF	Time Of Flight; sometimes used as an analog for along-track distance
TSOC	Tombaugh Science Operations Center - SOC at SwRI in Boulder, CO
Tx	Transmit (line; pin-out; channel)
VSDC	Venetia Burney Student Dust Counter (more often just SDC)