

Rosetta/Mars Express/Venus Express Mission Control System (RMCS/MMCS/VMCS)

Data Delivery Interface Document

DDID

RO-ESC-IF-5003
MEX-ESC-IF-5003
VEX-ESC-IF-5003

Issue C2

21/02/2006



DOCUMENT APPROVAL **DCR370**

Prepared by; Rosetta / MEX / VEX
Ground Segment Teams

Approved by (ESA/ESOC); A. Ercolani (OPS-GDS)
Rosetta/MEX/VEX Technical Officer

Approved by (ESA/ESOC); P. Ferri (OPS-OPR)
Rosetta Spacecraft Operations Manager

Approved by (ESA/ESOC); M. Denis (OPS-OGM)
MEX Spacecraft Operations Manager

Approved by (ESA/ESOC); A. Accomazzo (OPS-OPV)
VEX Spacecraft Operations Manager

Approved by (ESA/ESTEC); G. Schwehm (SCI-SB)
Head, Planetary Missions Division

Approved by (RAL/SOG); T. Dimbylow (RAL/SOG)
Head of Satellite Operations, RAL

Approved by (Contractor); R. Corkill (VEGA IT GmbH)
Contractor Project Manager

Distribution List

Recipient	Project	Organisation
P. Ferri	ROS	ESOC (OPS-OPR)
M. Denis	MEX	ESOC (OPS-OGM)
A. Accomazzo	VEX	ESOC (OPS-OPV)
M. Warhaut	ROS	ESOC (OPS-OP)
M. McKay	MEX	ESOC (OPS-OGM)
G. Schwehm	ROS	ESTEC
A. Chiccaro	MEX	ESTEC
H. Svedhem	VEX	ESTEC
R. Schmidt	MEX	ESTEC
D. Mc Coy	VEX	ESTEC
R. Corkill	ROS / MEX	ANITE
J. Wardill	MEX	ESOC (OPS-ON)
J. Fertig	ROS	ESOC (OPS-GFI)
V. Companys	MEX	ESOC (OPS-GFI)
H. Eggel	MEX/VEX	ESTEC
P. Martin	MEX	ESTEC
A. Ercolani	ROS	ESOC (OPS-GDS)
T. Bru	ROS/MEX/VEX	ESOC (OPS-GDS)
J. Ellwood	ROS	ESTEC
P. Gaudon	ROS	CNES
A. Balogh	ROS	Imperial College – Space & Atmospheric Physics Group Prince Consort Road London SW7 2BZ United Kingdom
Alan Stern	ROS	Southwest Research Institute 1050 Walnut Street #426 Boulder, CO 80302 USA
Angioletta Coradini	ROS	CNR Area di Ricerca di Tor Vergata – Via del Fosso del I-00133 Roma Italy

Recipient	Project	Organisation
Colin Pillinger	ROS	Planetary Sciences Research Institute - The Open University Walton Hall Milton Keynes MK7 6AA United Kingdom
Hans Balsiger	ROS	Universität Bern Sidlerstrasse 5 CH-3012 Bern Switzerland
Helmut Rosenbauer	ROS	Max-Planck-Institut für Aeronomie Max-Planck-Strasse 2 D-37191 Katlenburg-Lindau Germany
Horst Uwe Keller	ROS	Max-Planck-Institut für Aeronomie Max-Planck-Strasse 2 D-37191 Katlenburg-Lindau Germany
James Burch	ROS	Southwest Research Institute 6220 Culebra Road San Antonio, TX 78228-0510 USA
Jean-Gabriel Trotignon	ROS	LPCE-CNRS 3A, Av. de la Recherche Scientifique F-45071 Orleans Cedex 2 France
Jean-Pierre Bibring	ROS	IAS Universite Paris XI F-91405 Orsay Cedex France
Martin Hilchenbach DCR356	ROS	Max-Planck-Institut für Solar System Research (MPS) Max-Planck-Strasse 2 D-37191 Katlenburg-Lindau Germany
Karl-Heinz Glassmeier	ROS	Technische Universität Braunschweig Mendelssohnstrasse 3 D-38106 Braunschweig Germany
Luigi Colangeli	ROS	Osservatorio Astronomico di Capodimonte Via Moiariello, 16 I-80131 Napoli Italy
Martin Paetzold	ROS	Universität Köln Albertus-Magnus-Platz D-50923 Köln Germany
Rickard Lundin	ROS	Swedish Institute of Space Physics – Kiruna S-98128 Kiruna Sweden

Recipient	Project	Organisation
Rolf Boström	ROS	Swedish Institute for Space Physics – Uppsala S-75591 Uppsala Sweden
Samuel Gulkis	ROS	JPL - Jet Propulsion Laboratory 4800 Oak Grove Drive Pasadena, CA 91109-8099 USA
Hartmut Scheuerle	ROS	DLR, Institut für Raumsimulation Porz-Wahnheide D-51147 Köln Germany
Willi Riedler	ROS	Österr. Akademie der Wissenschaften Inffeldgasse 12 A-8010 Graz Austria
Wlodek Kofman	ROS	Laboratoire de Planetologie de Grenoble F-38041 Grenoble Cedex 9 France
G. Neukum	MEX	DLR, Rutherfordstrasse 2 D-12489 Berlin Germany
J.P. Bibring	MEX	IAS, Universite Paris XI F-91405 Orsay Cedex France
V. Formisano	MEX	IFSI-CNR Area Ricerca Tor Vergata Via Fosso del Cavaliere I00133 Rome Italy
G. Picardi	MEX	IFSI-CNR Area Ricerca Tor Vergata Via Fosso del Cavaliere, I00133 Rome Italy
R. Lundin	MEX	Swedish Institute of Space Physics S-98128 Kiruna Sweden
J.L Bertaux	MEX	Service d'Aeronomie, CNRS Route du Plessis-Piquet Verrieres-le-Buisson, BP3, 91371 France
M. Paetzold	MEX	Inst. für Geophysik und Meteorologie Universität zu Köln Albertus-Magnus-Platz D-50923 Köln, Germany
C. McCarthy	MEX	ESTEC

Recipient	Project	Organisation
C. Pillinger	MEX	Planetary Sciences Research Institute – The Open University, Walton Hall, Milton Keynes MK7 6AA, UK
H. Eggel	MEX	ESTEC
S. Barabash	VEX	Swedish Institute of Space Physics S-98128 Kiruna Sweden
T. Zhang	VEX	Institut fuer Weltraumforschung der Oesterreich. Akademie der Wissenschaft Schmiedlstr., 6 8042 Graz Austria
V. Formisano	VEX	IFSI-CNR Area Ricerca Tor Vergata Via Fosso del Cavaliere I00133 Rome Italy
J.L. Bertaux	VEX	Service d'Aeronomie, CNRS Route du Plessis-Piquet Verrieres-le-Buisson, BP3, 91371 France
B. Haeusler	VEX	Institut für Raumfahrttechnik Universität der Bundeswehr München Werner Heisenberg Weg 39 85577 Neubiberg Germany
G. Piccioni	VEX	Istituto di Astrofisica Spaziale e Fisica Cosmica Area della Ricerca CNR Tor Vergata Via del Fosso del Cavaliere 100 I-00133 Roma Italy
W. Markiewicz ^{DCR369}	VEX	Max Planck Institute for Solar System Research ^{DCR369} Max-Planck-Str. 2 37191 Katlenburg-Lindau Germany

Document Change Record

Date	Issue	Rev. No	Section Affected	Description/Reason		
30/04/99	Draft A0	-		Initial Draft		
16/07/99	Draft A1	-		Updated for comments received on Draft A0 (ref. E-mail, M.Sweeney, 11/05/99)		
23/02/00	Draft A2	-		Updated for comments of M.Warhaut and E.Sørensen		
28/02/00	Draft A3	-		Document approvals updated		
10/03/00	Draft A4	-		Updated to provide telemetry delivery by APID		
31/05/01	Issue B0	037	1.6	Updates in accordance with RIDs raised for Draft A4 review.		
			6.3			
			7.7			
			7.8.4			
			7.9.1.2			
			7.12.3			
			7.13.1			
			7.13.2			
			8			
			12			
31/05/01	Issue B0	038	7.8.1	Updates in accordance with RIDs raised for Draft A4 review.		
			7.8.2			
			8			
			12			
			039		7.6.2	Updates in accordance with RIDs raised for Draft A4 review.
					7.7.3	
			041		12	Updates in accordance with RIDs raised for Draft A4 review.
			042		7.13.2	Updates in accordance with RIDs raised for Draft A4 review.
					8	
			045		7.3.3	Updates in accordance with RIDs raised for Draft A4 review.
047	7.8.1	Updates in accordance with RIDs raised for Draft A4 review.				
048	8	Updates in accordance with RIDs raised for Draft A4 review.				
	7.8.2					
	12					

		049	7.9.4	
		050	7.8.1	
		059	7.8.4 7.13.2 8	
		065	12	
		067	5.4	
		084	6.2	
		087	7.8.1 7.9.1.2 7.12.4 7.13.1 7.13.2 7.13.5 8 12	
		088	3.2 4.1 4.2 4.3 5.1 6.1 6.2 7.1.1 7.1.3 7.1.4 7.3.1	
		089	3.2 6.2 6.5	
CONTINUES AS RO-ESC-IF-5003 / MEX-ESC-IF-5003				

Document Change Record MEX-ESC-IF-5003

Date	Issue	Description/Reason
01/09/00	Draft A1	Initial Draft
20/09/00	Draft 2	Editorial corrections & re-formatted
DISCONTINUED		

Document Change Record RO-ESC-IF-5003 / MEX-ESC-IF-5003

Date	Issue	Rev. No	Section Affected	Description/Reason
21/06/01	Issue B1	-	All	Updated to become a Rosetta / Mars Express common document
27/11/01	Issue B2	-	Document Approval	Rosetta PIs added to the signature page
	Issue B3	DCR No		Updated according to DDID review, 29 January 2002
		1	7.1.3.19	
		2	7.6.3	
		3	Appendix I	
		5	7.1.3.19	
		6	7.1.13.12	
		8	7.7.3	
		9	7.1.3.19	
		10	7.1.3.13	
		14	3.2, 7.8.1	
		15	3.3	
		16	5.1	
		17	6.2	
		18	4.3	
		19	7.1.3.12	
			7.1.3.14	
		20	7.1.3.19	
		21	7.1.4	
		22	7.9.1.1	

		23	Appendix A 7.11.1	
		24	Appendix A, I	
		25	7.1.3.2 7.5.1	
		32	7.2.2 13.2	
		36	Appendix C	
		37	Appendix D	
		38	Appendix J	
		40	Appendix I	
		41	7.13.2 7.11.1	
		42	7.13.2	
		43	7.13.2	
		44	5.8	
		48	Appendix A,E	
		50	Appendix H	
		53	6.4	
		57	Appendix C	
		59	6.2	
		60	6.2, 6.5	
		62	Appendix C	
		63	Appendix A	
		64	7.1.3.3	
		65	7.1.3.12	
		66	7.1.4	
		68	7.3.4	
		75	Appendix K	
		77	Global Appendix L	
24/06/02	Issue B4	117	Appendix A Appendix E	Updated according to CRID/DDID CCB 10 June 2002
		119	Dist. List	
		120	7.6.2	
		122	Appendix A	
		123	7.1.4	

		126	7.3.4 7.4.4 Appendix C	
		127	5.2	
		128	Appendix C	
		129	4.1, 4.2, 4.3 5.1, 6.1, 7.1.1, Appendix C, L	
		130	3.2, 3.3 7.1.3.1, 7.1.3.4 7.1.4	
		131	1.6, 7.4.3 Appendix I	
		132	7.1.3.67.1.3.19	
		133	6.5	
		135	Appendix A 7.3.3	
		139	Appendix I	
08/07/2002	Issue B4-1	119 120	Doc. Approval 7.6.2	Addition of MEX PIs to Document Approval + minor editorial corrections of Issue B4
27/03/2003	Issue B5	141 142 146 147 148 149 151 152 153 155 156 157 158 159 160 161	Appendix A, E Appendix C 7.1.3.19 Appendix C 5.1 Appendix C Appendix A Appendix A Appendix C 7.1.3.11 7.1.3.12 7.13.2 Appendix C 7.8.1 7.1.3.19 7.3.1 7.9.1.1	Updated according to DDID review, 18 December 2002

		163	9.2	
		164	7.6.2	
		165	7.1.3.13	
		167	Appendix I	
		168	5.1	
		169	Appendix C	
		171	0	
			7.1.3.21.6	
		188	7.1.3.6	
			Appendix C	
		190	5.1	
		193	7.3.4	
		195	Appendix A	
			Appendix C	
		196	7.6.3	
		201	7.4.3.2	
		202	7.4.4	
		204	Appendix A	
		205	18.1.2	
		206	1.4	
			5.5	
			7.1.3.1	
			7.1.3.13	
			7.1.3.14	
			7.1.3.19	
			7.6.3	
			7.8.1	
			7.8.3	
			7.13.3	
			Appendix A	
			Appendix E	
			Appendix K	
			Appendix L	
		211	18.1.2	
		212	Appendix K	
		213	Appendix K	
		214	Appendix K	
		215	7.6.2	

		216	7.7.2.2	
		218	1.6	
			1.7	
			Appendix K	
		219	Appendix E	
		220	7.7.2.2	
		222	7.1.3.19	
31/08/2003	Issue B6	150	19.4.2	Add MEX Science Comm. Network impl.
		215	7.6.2	24(hex) station_ID for Madrid
		224	8	New file type: "PORP", "PTRP"
			12	
		226	1.2	Remove the "quick-look" concept
			4.1	
			19.2	
			19.3.3	
		227	3.3	Clarification of RDMs for Mars Express
		232	Appendix E	Remove file type "SECS" file type
		246	7.6.2	Ground Station ID for Time Correl. Pkts
		248	Appendix A	AGC1, AGC2, G1FD and G2FD file types
			Appendix E	
		263	0	DAF – update TYPE field
		265	Appendix C	Replace Reference A-8 by A-6
		268	Appendix A	Add ORGR File Type for third Earth Flyby
			Appendix E	
		269	7.9.1.1	Master Catalogue is disabled for TM
		270	7.1.3.19	S2KpktsGenTime and the SPLITTED files
		274	7.1.3.19	Explain retrieval of TC Packets
		284	7.13.1	Replace AUX by AUXF
		285	7.13.4	CD ROM Label
12/07/2004	Issue C0	304	7.13.1	RDM naming convention updated
		275	8	Move file type SPL_ from MEX to ROS
		316	8	Updated Super APIDs
		305	7.6.2	GS ID updates
		307	7.13, 8, 12	New asteroids: Lutetia, Steins
		252	9.1	Updated for VEX
		316	9.1	Unified error messages for MEX and ROS
		314	18.3.3.3	Added TC REQUEST ID field.

		252	All	Updates for VEX (doc title and name)
01/07/2005	Issue C1	325	1, 3.4, 18.3.1.1, 18.3.1.2 3.3 6.5 7.1.3.4 7.1.3.10 7.6.3 7.11.1 8 12 18.1.2.1.2	VMCS added whenever RMCS/MEMCS are mentioned. First bullet freq. of VEX RDM production is TBD. VEX RDM production is TBD. Note 2 applicable to all three missions. VEX added. Added ref. to AD-3 VEX strategy for RDM production is TBD. File names updated for VEX. Separate table created for VEX. Applicable to VEX also.
		330	8	Pad PTR and FTL with underscore
		-	8, 12	It is 'flight dynamics', not 'file dynamics'
		341	8	Added Super APIDs for VEX
		343	8, 12	File names updated for VEX (new file types added and file type "SECS" removed)
		210	17	References to MEX/VEX OCDs
		317	A-4	EVTR updates to Appendix H
		318	6.2, 6.5	Add Telecommands
		319	6.5	Updated MEDDS RDM delivery timing
		320	7.1.3.19	Corrected formatting
		321	7.1.4	Clarified wording
		322	7.1.4	Matched example with descriptive table
		323	7.5.1	Added Telecommands
		327	1.7, 6.3	Corrections
		329	1.4, 1.5	Removed outdated details.
		332	18.3.2.4, 18.3.3.3, 18.3.3.4	No parameter records for command deletions
		336	7.6.2	Fixed Madrid station ID
		348	-	Covered by DCR343
		356	Distribution List	Updated COSIMA PI details
		294	11	Added RDM detail list
		367	8	New Super-APIDs for RPC
		369	Distribution List	Updated VMC details.
		370	Approval List	Rationalization.
21/02/2006	Issue C2	386	All	Fixed document corruption where a number of single characters had been replaced by

				single or double quotation marks.
--	--	--	--	-----------------------------------

Table Of Contents

1.	Introduction.....	1
1.1	Purpose	1
1.2	Scope	1
1.3	Summary	1
1.4	Amendment History	1
1.5	Change Forecast.....	1
1.6	Applicable Documents.....	1
1.7	Reference Documents.....	2
1.8	Abbreviation.....	3
2.	Operational Assumptions and Constraints.....	4
2.1	Assumptions	4
2.2	Constraints	4
3.	Requirements	5
3.1	Functional Requirements	5
3.2	On-line Data Delivery Requirements.....	5
3.3	Off-line Data Delivery Requirements.....	6
3.4	Introduction to Standard Formatted Data Units.....	8
4.	Interface Characteristics.....	9
4.1	Interface Location and Medium	9
4.2	Hardware Characteristics and Limitations.....	9
4.3	Data Source, Destination and Transfer Mechanism	9
4.4	Node and Device Addressing.....	9
4.5	Relationships with other Interfaces	10
5.	Access.....	11
5.1	Interface Utility Software	11
5.2	Failure Protection, Detection and Recovery Procedures	12
5.3	File Naming Convention	12
5.4	Storage and File Detection Requirements	12
5.5	Security Requirements	12
5.6	Data Integrity Checks	12
5.7	Backup Requirements	13
5.8	Error Handling	13
5.8.1	Transport/Network Layer.....	13
5.8.2	Application Layer	13
6.	Detailed Interface Specifications	14
6.1	Data Structure	14

6.2	Generation Method	14
6.3	Data Passed Across the Interface and their Direction.....	15
6.4	Size and Frequency of Transfers	15
6.5	Timing and Synchronisation Requirements.....	16
7.	Data Definition	17
7.1	On-line Data Request	17
7.1.1	Data Item Characteristics	17
7.1.2	Header Records.....	17
7.1.3	Data Records.....	17
7.1.4	Example.....	29
7.2	Response to On-line Data Request.....	31
7.2.1	Data Item Characteristics	31
7.2.2	Header Records.....	31
7.2.3	Data Records.....	31
7.2.4	Example	32
7.3	Acknowledgement	33
7.3.1	Data Item Characteristics	33
7.3.2	Header Records.....	33
7.3.3	Data Records.....	33
7.3.4	Example.....	34
7.4	Catalogue Entry	36
7.4.1	Data Item Characteristics	36
7.4.2	Header Records.....	36
7.4.3	Data Records.....	36
7.4.4	Example	37
7.5	On-line Data.....	39
7.5.1	Data Item Characteristics	39
7.5.2	Header Records.....	39
7.5.3	Data Records.....	39
7.5.4	Example	39
7.6	Telemetry Data	40
7.6.1	Data Item Characteristics	40
7.6.2	Header Records.....	40
7.6.3	Data Records.....	41
7.6.4	Example	42
7.7	Command History Data ^{037 039}	44
7.7.1	Data Item Characteristics	44
7.7.2	TC Raw Packets	44

7.7.3	TC Printout	47
7.7.4	Example – Brief Mode	51
7.7.5	Example – Full Mode.....	52
7.8	Auxiliary Data	55
7.8.1	Data Item Characteristics	55
7.8.2	Header Records	55
7.8.3	Data Records.....	55
7.8.4	Example.....	56
7.9	Catalogue Data.....	57
7.9.1	Data Item Characteristics	57
7.9.2	Header Records	57
7.9.3	Data Records.....	57
7.9.4	Example.....	58
7.10	Error Message	59
7.10.1	Data Item Characteristics	59
7.10.2	Header Records	59
7.10.3	Data Records.....	59
7.10.4	Example.....	59
7.11	Off-line Data Delivery	61
7.11.1	Data Item Characteristics	61
7.11.2	Header Records	61
7.11.3	Data Records.....	61
7.11.4	Example.....	62
7.12	RDM (SFDU View)	63
7.12.1	Data Item Characteristics	63
7.12.2	Header Records	63
7.12.3	Data Records.....	64
7.12.4	Example.....	65
7.13	RDM (File View)	69
7.13.1	RDM Directory Structure	69
7.13.2	RDM File Naming Conventions	70
7.13.3	Version Control.....	72
7.13.4	Physical RDM Identification.....	75
7.13.5	Data Description Information.....	75
8.	Appendix A: Data Streams Available and ADIDs.....	77
9.	Appendix B: DDS Error handling.....	84
9.1	DDS Generated Error Messages	84
9.2	Contact Points in Case of Problems.....	85

10.	Appendix C: Accounts	86
11.	Appendix D: Full MEX RDM Directory and File Listing	87
12.	Appendix E: List of DDS Auxiliary Data.....	91
13.	Appendix F: Standard Formatted Data Units (SFDUs)	96
13.1	Overview of the Standard Formatted Data Unit (SFDU) Concept.....	96
13.2	SFDU Building Blocks - The Label-Value-Object	96
13.3	Overview of CCSDS Defined ADIDs	98
13.4	SFDU Structuring.....	98
13.4.1	Simple LVOs	99
13.4.2	Compound LVOs	99
13.5	EDU Structure Diagram	101
13.6	Packaging Techniques	102
13.6.1	Envelope Packaging	102
13.6.2	Referencing Technique - the Replacement Service.....	103
14.	Appendix G: Physical Data Nomenclature Conventions	105
14.1	ASCII Codes Definition	105
14.2	Bit and Octet Numbering Conventions	106
15.	Appendix H: Data Delivery Flight Dynamics Products	107
16.	Appendix I: Request Dialogue XML Schema	108
17.	Appendix J: Data Delivery Mars/Venus ^{DCR210} Express MPS Products.....	109
18.	Appendix K: MCS Products	110
18.1	MCS Telemetry Packets	110
18.1.1	Externally Generated Packets Reassigned by MCS	110
18.1.2	Telemetry Packet Generated by MCS.....	110
18.2	Lander Telecommand Verification File (LTVF).....	114
18.2.1	Introduction	114
18.2.2	Interface Definition.....	115
18.2.3	LTVF File Example	115
18.3	Detailed Agenda File (DAF).....	116
18.3.1	Introduction	117
18.3.2	Interface Definition.....	117
18.3.3	Record Definitions	121
18.3.4	Parameter Value Formats.....	126
18.3.5	DAF File Example	127
19.	Appendix L: Network Implementation Document	129
19.1	Introduction	129
19.2	Scope.....	129
19.3	Network requirements.....	130

19.3.1	Services	131
19.3.2	Bandwidth requirements.....	132
19.3.3	Quality of Service/Availability requirements	133
19.3.4	Security requirements.....	133
19.3.5	Service management requirements	133
19.4	Network Implementation.....	134
19.4.1	Rosetta Science Communication Network implementation	134
19.4.2	MEX Science Communication Network implementation	136
19.4.3	Security implementation	136
19.4.4	Addressing and Routing	136
19.5	Network services agreement.....	137
19.5.1	Operations and Maintenance	137
19.5.2	ESA Contacts and Coordination.....	137
19.5.3	DDS Access and Accounts	138
19.6	SCHEDULE	138

Appendix C: PI Account Details is provided as a separate document (A-6).^{DCR147}

Appendix H: Data Delivery Flight Dynamics Products is provided as a separate document (A-4).

Appendix I: Request Dialogue XML schema is provided as a separate document.(A-7)

Appendix J: Mars Express Auxiliary files

Appendix K: RMCS/MEMCS Products.

1. Introduction

1.1 Purpose

The purpose of this document is to define the data delivery interface between the Rosetta, Mars Express, and Venus Express^{DCR325} Mission Control Systems (RMCS, MEMCS and VMCS^{DCR325}) and their respective science communities.

The RMCS, MEMCS and VMCS^{DCR325} systems are located at the European Space Operations Centre (ESOC) in Darmstadt Germany, and used for the control and monitoring of the Rosetta/MEX/VEX^{DCR325} spacecraft following launch. The functions of the Mission Control Systems are described in the reference documents R-1 and R-2.

The systems are large and complex comprising a number of separate components. The component of the RMCS/MEMCS/VEX^{DCR325}, which is responsible for supporting the interface to the science communities is called the Data Disposition System (DDS).

1.2 Scope

The format of the following three types of data are defined in this document.

- a) Requests for on-line data sent by the Principal Investigators (Pis) to the DDS
- b) The on-line data sent by the DDS to the Pis, in response to their requests
- c) Off-line full data sets on Raw Data Media (RDMs) sent from the DDS to the Pis

Together with R-3, this document defines the complete interface between the RMCS/MEMCS/VMCS^{DCR325} and the science communities.

1.3 Summary

This document the Data Delivery Interface Document (DDID) is the Interface Control Document (ICD) governing the data delivery of the RMCS/MEMCS/VMCS^{DCR325} to the Pis.

In addition to the formal definition of the interface, this document aims to provide a basic overview of the Standard Formatted Data Unit (SFDU), which is used for the packaging of the data delivered.

1.4 Amendment History

As stated in the Document Change record at the start of the document.^{DCR329}

1.5 Change Forecast

No major updates are planned.^{DCR329}

1.6 Applicable Documents

- A-1. Recommendation for Space Data System Standards: Standard Formatted Data Units – Structure and Construction Rules (CCSDS 620.0-B-2.1, Blue Book, Issue 2, Consultative Committee for Space Data Systems, November 1996).
- A-2. ESA Packet Telemetry Standard (ESA-PSS-04-106).
- A-3. Rosetta/MEX Generic TM/TC ICD, MEX-MMT-IF-0936, Issue 2, Rev. 2, 30th August 2001^{DCR218}

- A-4. Data Delivery FD Products RO-ESC-IF-5003/MEX-ESC-IF-5003/VEX-ESC-IF-5003 Appendix H, Issue 3.2, 1st July 2006 ^{DCR317}
- A-5. Rosetta Project Glossary (RO-ESC-LI-5001, Issue A0, 15th May 1999)
- A-6. PI Account Details. RO-ESC-IF-5003/MEX-ESC-IF-5003/VEX-IF-5003 Appendix C, Issue C2, 21st February 2006 ^{DCR188, DCR218}
- A-7. Generic DDS request dialogue XML schema. RO-ESC-IF-5003/MEX-ESC-IF-5003/VEX-ESC-IF-5003 Appendix I, Issue C2, 21st February 2006 ^{DCR 131, 139}
- A-8. SOP-RSSD Software Specification Document, SOP-RSSD-SP-002_2.0_PTR_Software_Specification_Document_2002Aug06., 06 Aug 2002 ^{DCR224}
- A-9. IFMS-OCC Interface, Interface Control Document, Ref. /MakaluMedia/MR/IFMS/ICD/FTP-OCC, Issue 9.3.1, 09 April 2003 ^{DCR248}
- A-10. VEX Generic TM/TC ICD, VEX.T.ASTR.ICD.00326, Issue 2.0, 3rd Feb 2004

1.7 Reference Documents

- R-1. R(ME)MCS User Requirements Document (RO-ESC-RS-5310, Issue 2, 19th June 1998).
- R-2. R(ME)MCS Software Requirements Document (RO-ESC-RS-5320, Issue B3, 15th Dec 2000).
- R-3. RMCS/MEMCS Command Request Interface Document (RO-ESC-IF-0004, Issue C1, 1 July 2005 ^{DCR327}).
- R-4. Report Concerning Space Data System Standards: Standard Formatted Data Units – A Tutorial (CCSDS 621.0-G-1, Green Book, Issue 1, Consultative Committee for Space Data Systems, May 1992).
- R-5. Recommendation for Space Data System Standards: Standard Formatted Data Units – Control Authority Procedures (CCSDS 630.0-B-1, Blue Book, Issue 1, Consultative Committee for Space Data Systems, June 1993).
- R-6. Recommendation for Space Data System Standards: Time Code Formats (CCSDS 301.0-B-2, Blue Book, Issue 2, Consultative Committee for Space Data Systems, April 1990).
- R-7. Recommendation for Space Data System Standards: Parameter Value Language Specification (CCSD0006) (CCSDS 641.0-B-1, Blue Book, Issue 1, Consultative Committee for Space Data Systems, May 1992).
- R-8. Report Concerning Space Data System Standards: Parameter Value Language – A Tutorial (CCSDS 641.0-G-1, Green Book, Issue 1, Consultative Committee for Space Data Systems, May 1992).
- R-9. Recommendation for Space Data System Standards: ASCII Encoded English (CCSD0002) (CCSDS 643.0-B-1, Blue Book, Issue 1, Consultative Committee for Space Data Systems, November 1992).
- R-10. MARS Express MCS Delta User Requirements Document (MEX-ESC-RS-5310, Issue 1, 11th September 2000).
- R-11. W3C Recommendation – Extensible Markup Language (XML) 1.0 (Second Edition, 6 October 2000) (<http://www.w3.org/TR/REC-xml>)
- R-12. W3C Recommendation – XML Schema Part 0: Primer (2 May 2001) (<http://www.w3.org/TR/xmlschema-0/>)

- R-13. W3C Recommendation – XML Schema Part 1: Structures (2 May 2001)
(<http://www.w3.org/TR/xmlschema-1/>)
- R-14. W3C Recommendation – XML Schema Part 2: Datatypes (2 May 2001)
(<http://www.w3.org/TR/xmlschema-2/>)
- R-15. Consolidate Report on Mission ANALYSIS (CREMA) (MEX-ESC-RP-5500) Issue 2.
- R-16. MEX Space Ground ICD (ME-ESC-IF-5001, Issue 4.1, 16th December 2002)^{DCR218}
- R-17. Rosetta/MEX Software User manual for the PM firmware (Firmware TM/TC ICD), RO-SES-TN-2029, Issue 7, 25th October 2001^{DCR218}
- R-18. Rosetta/MEX DMS-SW (and AOCMS-SW service layers) TM/TC ICD, MEX.MMT.IF.0750, Issue 3, Rev. 0, 15th January 2003^{DCR218}
- R-19. Mars Express SSMM TM/TC and Software ICD, MEX.MMT.IF.0365, Issue 2, Rev. 1, 31st January 2002^{DCR218}
- R-20. Mars Express AOCS Application Software TM/TC ICD, MEX-MMT-IF-0861, Issue 4, Rev. 0, 4th March 2002^{DCR218}
- R-21. Rosetta/Mars Express Star Tracker TM/TC and Software ICD, MEX-MMT-IF-0463, Issue 4, Rev. 0, 19th November 2001^{DCR218}
- R-22. Mars Express Payloads and Lander TM/TC and Software ICD, MEX-MMT-IF-1264, Issue 3, Rev. 0, 24th January 2003^{DCR218}
- A-11. VEX Space Ground ICD VEX-ESC-IF-5002, Issue 2.3, 16th February 2004

1.8 Abbreviation

All abbreviations and acronyms used in this document are explained in Applicable Document A-5.

2. Operational Assumptions and Constraints

2.1 Assumptions

1. The requirements are as defined in chapter 3.

2.2 Constraints

1. No special constraints have been identified.

3. Requirements

3.1 Functional Requirements

The RMCS/MEMCS/VEMCS functional requirements regarding the data delivery interface to the Pis are described in:

- R-1 Section 9.2 (Data Disposition System)
- R-2 Section 11 (Data Disposition System)

These requirements are outlined below.

3.2 On-line Data Delivery Requirements

The following requirements are taken from R-1.

1. Data shall be delivered to the users by file transfer or across a Web interface⁰⁸⁸.
2. Each transfer shall take place as a result of a user request for data.
3. The system shall function in a client-server mode, that is it shall respond to requests, and not in an interactive mode. The DDS shall act as the server.
4. A single request file from the user shall contain one request command.
5. A single request command shall be able to request:
 - A subset of packets from a specified data source (i.e. APID)^{DCR130};
 - A single auxiliary file (e.g. orbit, attitude, calibration data, etc.)
 - A set of auxiliary files of a specific type, covering a specified time range.
 - A list of all data in the archive available to the DDS (i.e. a catalogue)
6. In the nominal case, the DDS shall supply the requester with the following information, all within the same file transfer:
 - An acknowledgement of his request.
 - A catalogue entry, giving identification information about the data supplied; this shall include source/type identification, time period spanned by the data, etc.
 - The requested data set itself.
7. In the non-nominal case, i.e. failure to satisfy the request, the DDS shall supply the requester with an error message in the acknowledgement.
8. The requester should receive the start of the requested data from the DDS within 15 minutes after the DDS receives the request.

Obviously, this is subject to the data volume requested and system and network load, especially during a ground station pass phase.
9. Data shall be available on-line to the users for 3 months after acquisition from the spacecraft.
10. The DDS shall limit access to the data to a list of authorised users.
11. The DDS shall allow each user to queue up to 12 requested data files at any one time.

12. The DDS shall be able to deliver at least a total of 1000^{DCR 053} Mbytes in a single day (from 00:00:00 inclusive until 00:00:00 of the next day exclusive)
13. If a single requested data file would result in the total data delivered in a single day to exceed the maximum permitted, then the whole of that file shall not be delivered. Any further requests exceeding this limit shall be rejected by the DDS, and a suitable error message returned.
14. There shall be a configurable split of the maximum data delivery quota between the various users. The maximum quota per user per day shall be decided by consultation between the users and the Project Scientist. The quota per user shall be configurable by software support.

The following additional requirements were identified during the review of R-2.

15. It shall be possible to request telemetry data with a sample rate N, indicating that every Nth packet within the specified time window shall be delivered.
16. The use of wild cards for catalogue queries shall be supported.

The following additional requirements were identified during review of Draft A4 of this document.⁰⁸⁹

17. It should be possible to configure the system to automatically send selected Auxiliary files to PI, if a new version of the file is received by the system.⁰⁸⁹
18. It should be possible to configure the system to automatically send selected TC/TM data periodically to a designated PI.⁰⁸⁹

3.3 Off-line Data Delivery Requirements

Note: Off-line data delivery may only be required to produce a suitable archive medium. RDM delivery to Pis is planned for Mars Express and Venus Express, but not for Rosetta^{DCR 023}. Requests for RDM delivery are not allowed via the Web or FTP interfaces. RDM production is always initiated inside ESOC using the automatic scheduler.^{DCR130}

1. The data shall be delivered on a random access raw data media (RDM). For Mars Express and Venus Express the selected RDM is the CD-ROM.^{DCR227}

Each RDM shall contain a (configurable – the same for all RDMs once established) integer number of days worth of data. The start of each day is defined as the first data packet time stamped at 00:00:00.00 time (midnight) inclusive or the first packet after this time, and the end of the day is defined as the latest packet time stamped before 00:00:00.00 time (midnight) of the next day. *The default number of days is set to "1" day per CD-ROM for Mars Express^{DCR227} and TBD^{DCR325} for Venus Express*

2. If more than one RDM is needed to store the defined number of days worth of data, then the first RDM for the first day of the period will be filled until a predefined limit is reached, and then a second RDM continued from that point onwards. There will therefore be a certain point in time (dictated by the predefined limit) at which all the data streams will continue on the second RDM. This can of course be applied to a third or fourth RDM, there being maximum handling limit of 4 RDMs.

It is recommended to set the default number of days such that normally only one RDM is required for each period.

3. Only auxiliary data relevant to the same period as the actual telemetry data shall be delivered on each RDM.

4. All data on the RDM shall be accompanied by the relevant data format descriptions. These shall be contained on each RDM.

In this way each RDM is completely self-describing. The overhead of repeating the data descriptions on each RDM is negligible given the anticipated capacity of the RDMs.

5. The RDM production system shall allow delivery of the RDMs to the authorised distribution list within 1 month of reception of the same data at the OCC.^{DCR227}
6. The split by day is based on the following time key associated to each TM packet: On Board Generation Packets time (equivalent to the Source Packet Generation time).^{DCR 015}

3.4 Introduction to Standard Formatted Data Units

The driving requirement for the formatting of data on the DDS is the need to handle a variety of packet sizes (e.g. the instrument data packets and the various packets of auxiliary data) and file sizes. The number of packets in the various files over a given time span can differ according to the planned operations of the corresponding instruments. For delivery of data on the RDM, the data must be delivered complete with data format descriptions so that each and every RDM is stand alone and does not require any external documentation or knowledge to understand the data. There must be a simple method of linking these data descriptions with the data that they describe. Furthermore, there must be no significant overhead imposed on the Rosetta/MEX/VEX^{DCR325} science communities by packaging techniques or structuring of the delivered data, whether it be on-line or off-line delivery.

The particular technique proposed corresponds to an already published CCSDS Recommendation, see A-1, defining structure and construction rules for the Standard Formatted Data Unit (SFDU).

The SFDU concept is applied to Rosetta/MEX/VEX's^{DCR325} on-line data delivery in a very simple way, so that the overhead to the Pis is minimal, and in the extreme situation, the Pis can treat the extra header fields involved as "spare" bytes.

For off-line data delivery on RDM, SFDUs are also used. They provide a method of packaging together and logically labelling (identifying) all the files on the RDM. The data files shall be accessible directly with no SFDU labelling overhead for those science community members who wish to access some particular data and already know exactly where that data is on the RDM. However, the SFDU packaging used for the data on the RDM shall allow science community members with no previous knowledge of the file structure being used to find and retrieve data and its relevant description.

An awareness of the SFDU concept shall help each science community member to build a more resilient data handling system and provide better visibility of data structures, particularly for common data and if needed, interchange of data between science community members. The SFDU concept also provides a technical and administrative framework for handling and exchanging of data descriptions.

Appendix F gives a brief description of the SFDU concept and the data packaging techniques used sufficiently enough to permit understanding of the SFDU implementation proposed in this document. This appendix must first be understood so that the data structures presented here can be followed. The interested reader is recommended to read A-1 for a full description and R-4 for a tutorial on the SFDU concept.

4. Interface Characteristics

4.1 Interface Location and Medium

The three interfaces are described in turn.

- a) The requests for on-line data are made via FTP^{DCR129} or⁰⁸⁸ Web interface.
- b) The on-line data sent in response to requests, can be returned via^{DCR129} FTP or the Web interface. The request indicates the response type to be used and the options available are dependent on the type of request. The following table shows the possible combinations:⁰⁸⁸

<i>Request</i>	<i>Response</i>
Web Interface Request	Table D FTP single file containing all data relating to the request to specified PI node b) Return data via Web interface
FTP Request	FTP single file containing all data relating to the request to specified PI node

- c) The off-line full data sets on Raw Data Media (RDMs) are CD-ROM^{DCR227}

4.2 Hardware Characteristics and Limitations

The DDS hardware comprises a Sun/Solaris 8 server with 1GB memory.^{DCR 046}

The PI hardware shall support:

- a) Web interface for on-line data requests and responses⁰⁸⁸
- b)^{DCR129}FTP for making on-line data requests and⁰⁸⁸ receiving the on-line data files
- c) RDM reader for reading the off-line data sets

4.3 Data Source, Destination and Transfer Mechanism

The data source is the DDS. The data destination is a computer at the PI home institute.

The transfer mechanism is:

- a) Web interface for the on-line data requests and responses⁰⁸⁸
- b) All file transfers are performed with standard FTP, subject to the special two step process identified in section 5.2.^{DCR 008 DCR 129}
- c) RDM for the off-line data sets (long term archives, not to Pis)

4.4 Node and Device Addressing

See Appendix C.

4.5 Relationships with other Interfaces

Together with the Command Request Interface Document (CRID, ref. R-3), the DDID defines the complete interface between the RMCS/MEMCS/VEMCS and the science communities.

This DDID is broadly based on the Cluster DDID.

5. Access

5.1 Interface Utility Software

No interface utility software over and above a Web interface^{DCR129} is foreseen.

The user can make their request in one of two ways:⁰⁸⁸

- Through a Web interface
- Via^{DCR129} FTP using an ASCII file to contain the request

The Web interface can be found at the following URLs^{DCR 016}

- For Rosetta, <http://rodds.esa.int>
- For Mars Express, <http://medds.esa.int>
- For Venus Express <http://vedds.esa.int>^{DCR252}

The^{DCR129} FTP interface can be found at the following URLs

- For Rosetta, <ftp://rodds.esa.int>^{DCR168}
- For Mars Express <ftp://medds.esa.int>^{DCR168}
- For Venus Express <ftp://vedds.esa.int>^{DCR252}

Access is protected by user name and password, and requires the user to contact ESOC to obtain access to the protected pages of the site. Both the^{DCR129} FTP interface and the Web interface support the following requests:

- Define and submit an on-line data request
- Receive on-line data responses
- Receive error messages

Data delivered by the DDS via FTP will come from one of the following IP addresses:^{DCR190}

- ESOC firewall, 195.74.161.170 or 195.74.161.173
- Rosetta DDS, 195.74.173.230
- Mars Express DDS, 195.74.173.232
- Venus Express DDS 195.74.163.148^{DCR366}

Any queries regarding the DDS should be sent by email to the DDS support account for the mission:^{DCR148}

- Rosetta: rosetta.dds@esa.int
- Mars Express : mex.dds@esa.int
- Venus Express vex.dds@esa.int^{DCR252}

5.2 Failure Protection, Detection and Recovery Procedures

In the case of transmission failure of on-line data, the DDS will try and retransmit the file a number of times (configurable by DDS support at ESOC). If a PI does not receive a either a reply or an error message within 2 hours, then he must assume that the request has failed and resubmit the request.

In order to protect against partial transmissions and difficulties of knowing when a transfer is complete, FTP transfers in both directions must use a two-step process using a temporary filename, as demonstrated in the example below:^{DCR127}

```
ftp>put request.XML request.TMP  
ftp>rename request.TMP request.XML
```

Otherwise, no failure protection, detection and recovery procedures over and above those provided by the Web interface and FTP are foreseen. In the case of continued problems with the system the contact points, given in section 9.2, should be followed.⁰⁶⁷

5.3 File Naming Convention

The file naming conventions are defined in section 7.1.3.3 and 7.13.2.

5.4 Storage and File Detection Requirements

For on-line data, the Mars Express DDS shall provide access for at least 3 months after acquisition from the spacecraft. Older data is available on the RDMs. . .

While the Rosetta DDS shall provide access to the on-line data for the entire mission duration.

There are no file detection requirements.

5.5 Security Requirements

The computers hosting the DDS software are located on ESOC's front-end LAN and are accessible from outside ESOC. It should be noted that all other machines hosting the RMCS/MEMCS/VEMCS software are located on ESOC's operational LAN, which is protected from the DDS by a bridge.

For on-line data requests:

- Access is restricted to a list of authorised users.
- The list of authorised users can only be modified with the permission of the Project Scientist.
- The Web interface will be password protected.
- For each authorised user, the on-line data delivery will be made to a pre-specified node, whose address can only be modified with the permission of the PI.^{DCR206}
- All authorised users will be permitted to access the auxiliary data. Otherwise, users will be restricted to accessing data from a particular experiment.

The RDMs will contain full data sets (i.e. all the common data and all the data from all the experiments).

5.6 Data Integrity Checks

No data integrity checks over and above those provided by the protocol used are foreseen.

5.7 Backup Requirements

The DDS is foreseen to have a prime and back-up node, in case of failure.

5.8 Error Handling

In the event of invalid on-line data requests, or errors in transferring the on-line data, error messages will be reported to the user, as defined in Appendix B.

The problem reporting procedure for Pis is also described in Appendix B.

Since the public internet is used, outages of several days are possible. ^{DCR 044}

5.8.1 Transport/Network Layer

DDS is accessible over the public internet.

Specific Network / Routings from particular users are not defined in this document.

5.8.2 Application Layer

See above.

6. Detailed Interface Specifications

6.1 Data Structure

The three interfaces are described in turn.

- a) The on-line data requests, via ^{DCR129}FTP or Web Interface ⁰⁸⁸
- b) The on-line data responses, via ^{DCR129}FTP or Web Interface ⁰⁸⁸
- c) The off-line data are transferred on RDM i.e. CD-ROM for Mars Express and Venus Express only ^{DCR228}

6.2 Generation Method

The on-line data responses ⁰⁸⁸ are generated by extracting data from the RMCS/MEMCS/VEMCS Data Archive System (DAS). The DAS is a repository for all RMCS/MEMCS/VEMCS data, and provides services to allow other components of the RMCS/MEMCS/VEMCS software to read from and write to the archive. In contrast to the other RMCS/MEMCS/VEMCS components, the DDS accesses the DAS from outside the ESOC operational LAN.

In the case of Telemetry Data, the data will be available for retrieval as soon as stored at the MCS. For VC0 this is normally within seconds of reception at the ground station ^{DCR059}

The off-line data files are generated by an RDM production facility. This again uses the DAS. (Note: the DAS shall not be confused with the long term data archive)

In addition the DDS can be configured to automatically send certain data to designated Pis. The data that can be send are: ⁰⁸⁹

<i>Data Type</i>	<i>What is Sent to PI</i>	<i>When is data sent?</i>
Auxiliary File	Complete file	When a new version of the auxiliary file is archived in the DAS
Telemetry Packets	A single file containing all Telemetry packets for a given APID, type, subtype, p1, p2 values ^{DCR017} over a configured time period	In a configured periodic cycle.
Telecommands ^{DCR318}	A single file containing the specified TC information over a configured time period. ^{DCR318}	In a configured periodic cycle. ^{DCR318}

A PI must register their interest in such a service by contacting ESOC, who will validate the request, and configure the system to support the service requested. ⁰⁸⁹

For automated telemetry packet delivery, the information required to configure automatic requests includes ^{DCR060}

- A nominal on-line request, including necessary keywords.
- Nominal Start time for automatic request process.

- Request Frequency
- Start/end times expressed as a delta time from each request

For example, if the user wants data every 24 hours, he might one might configure for 00:00:00 (midnight) on 1-Jan-2002 with 24 hour frequency, start time –25 hours end time –1 hour, to give automatic delivery of data from 11pm to 11pm, once per day..^{DCR 060}

6.3 Data Passed Across the Interface and their Direction

The data, which is passed across the interface, and the direction in which it is passed, is summarised in the table below.

Data Item	Where Defined	Direction
On-line Data Request	7.1	To the DDS
On-line Response	7.2	From the DDS
Acknowledgement	7.3	From the DDS
Catalogue Entry	7.4	From the DDS
On-line Data	7.5	From the DDS
Telemetry Data	7.6	From the DDS
Command History Data ⁰³⁷	7.7	From the DDS
Auxiliary Data	7.8 ^{DCR327}	From the DDS
Catalogue Data	7.9	From the DDS
Error Message	7.10	From the DDS
Off-line Data Delivery	7.11	From the DDS
RDM (SFDU View)	7.12	From the DDS
RDM (File View)	7.13	From the DDS

6.4 Size and Frequency of Transfers

For the on-line delivery of data, the DDS is sized to handle a total of 1000^{DCR 053} MB per day (see reference document R-15). Within this overall limit, each PI will receive his own daily quota. At any one time, a PI may queue up to 12 requests.

Nominally, each RDM will contain 1 (one) day's worth of data. It should be noted, however, that:

- The production rate may be reduced during periods of low data generation. In this case, an RDM will contain an integer number of days of data
- The production rate may be increased during periods of high data generation. In this case, up to 4 RDMs may be produced to hold one day's data.

The DDS can be configured to send certain types of data automatically to Pis.

6.5 Timing and Synchronisation Requirements

For on-line data delivery, the DDS should nominally receive the start of the requested data within 15 minutes after the DDS receives the request. (This is subject to the data volume requested and network-load.)

For off-line data delivery, the MEDDS^{DCR319} should nominally deliver the RDMs within 3 weeks, VEDDS within TBD days^{DCR325}. (In order to generate a consolidated data set, the DDS needs to wait for dump data from the satellite.)

For automated data delivery, the DDS should nominally deliver the following types of data within the given limits:⁰⁸⁹

Data Type	Delivery Period
Auxiliary Files	Will be forwarded immediately on receipt. Subject to exceptions specified in Appendix A ^{DCR135}
Telemetry Data	At a regular, configurable rate containing a configurable period.
Telecommands ^{DCR318}	At a regular, configurable rate containing a configurable period. ^{DCR318}

Notes

- Data being delivered automatically may also be requested for normal online delivery.
- If an automatic delivery is missed (eg. The DDS is down), then a normal online request must be made for the missing data.

7. Data Definition

This chapter defines the characteristics of the data items listed in section 6.3.

7.1 On-line Data Request

7.1.1 Data Item Characteristics

The user can make an on-line data request in one of two ways:

- Through a Web interface
- Via ^{DCR129}FTP using an ASCII file to contain the request. The FTP transfer is subject to a special process, described in section 5.2. ^{DCR127}

This section describes both methods. ⁰⁸⁸

The Web interface maps to the XML/XSD based ASCII file interface, therefore structure and format information is given using the XML schema definition (XSD). All in built XML types have an xsd: prefix (see R14 for more details).

NOTE: An example of the XML request file and the corresponding Web page are given for each request type.

The XML schema is defined in Appendix I (A-7).

7.1.2 Header Records

N/A

7.1.3 Data Records

Each request is made up of a single group:

Field	XML type	Description
OnlineRequest	OnlineRequestType	Defines all the required information for a single DDS request

7.1.3.1 OnlineRequestType group

The OnlineRequestType contains the following fields:

Field	XML type	Description
general	RequestInfoType	This defines the PI account, delivery information, and format options.
Item (1 to n)	DataItemType	This defines the data to be requested. This group can be specified only once when building a request for Web or Online Delivery ^{DCR130} This group can be specified more than once when building an RDM based request.

Each of the fields in each of these groups is defined in the sections below.

The OnlineRequestType also contains the following attributes:^{DCR206}

Attribute	XML type	Description
userRequestId	xsd:string	Optional attribute that a PI can use to identify a request. The corresponding response from the DDS will have a matching userRequestId attribute.

7.1.3.2 RequestInfoType group

Field	XML type	Description
comment	xsd:string	Free format string that can be used by the PI to identify a request. This is not processed by the DDS.
UserInfo	UserInfoType	Contains information for identifying the PI account.
DestInfo	DeliveryType	Gives delivery method to use and delivery options such as number of RDMS.
FormatInfo	FormatInfoType	Contains data formatting options such as compression, SFDU formatting and mission specific format options.
DataInfo	DataInfoType	Contains options for specifying the overall data.

7.1.3.3 UserInfoType group

Field	XML type	Description
UserName	xsd:string	The PI account name for this request.
FTPpassword	xsd:string	FTP request password to use for this request.

NOTE: As a security measure ^{DCR 064}, the account password for accessing the DDS web site and the password for FTP ASCII file based requests are different.

7.1.3.4 DeliveryType group

The delivery group is composed of one, and only one, of the following fields:

Field	XML type	Description
RDM	RDMDeliveryType	Used to specify RDM based delivery. This group contains fields relevant to RDM delivery.
FTP	FTPDeliveryType	Used to specify FTP based delivery. This group contains fields relevant to FTP delivery.
Online	OnlineDeliveryType	Used to specify Online (Web) based delivery. This group contains fields relevant to Online delivery.

NOTE: The web interface will allow all three types of delivery, whereas the FTP interface will only allow RDM and FTP delivery as Online makes no sense in this context.

NOTE: Requests ^{DCR325} for RDM delivery are not allowed via the Web or FTP interfaces. RDM production is always initiated inside ESOC using the automatic scheduler. ^{DCR130}

7.1.3.5 RDMDeliveryType group

The RDM delivery field does not contain any fields but has the following attributes:

Field	XML type	Description
label	xsd:string	Label for the RDM. Must be specified, cannot be blank.
NumCopies	xsd:positiveInteger	Optional attribute specifying the number of copies to produce. Default value if not specified is 1.
MaxSpan	xsd:positiveInteger	Optional attribute specifying the maximum number of RDMs this request is allowed to span. Default value if not specified is 1.

7.1.3.6 FTPDeliveryType group

The FTP delivery group contains the following fields:

Field	XML type	Description
directory	xsd:string	A valid path for the file on PI FTP server, and will be different for machines running UNIX and VMS. This path is relative to the Default directory that is configured for each user ^{DCR132}

		Can be blank.
Filename	xsd:string	Destination filename. Must be specified, cannot be blank.
Target (0 to 1)	ReqString ^{DCR188}	FTP target name of the FTP server to which the response shall be sent. (If not specified, the response will be sent to a pre-configured default target.)

7.1.3.7 OnlineDeliveryType group

This group is not defined here as it is used internally by the web interface.

7.1.3.8 FormatInfoType group

The format info group contains the following fields:

Field	XML type	Description
compression	CompressionType	Used to specify compression method to use.
SFDUrequired	xsd:boolean	Set to 'true' is SFDU is required, else set to 'false'. Note: If SFDU not selected then the delivered data is 'raw', with no acknowledgement or catalogue information ^{DCR 025}
missionFormat	MissionFormatType	Optional field for specifying mission specific formatting.

7.1.3.9 CompressionType group

The compression group can contain one of the following values:

Value	Description
NONE	No compression of data.
ZIP	This option specifies that the file to be delivered should be compressed prior to transmission over the network, using the commonly available 'ZIP' algorithm. Note, that the complete resultant file including acknowledgement, catalogue and data will be compressed as a single file. Packages for 'UNZIPing' the received compressed file are readily available for all common hardware/software platforms, including UNIX, VMS, DOS and Mac (these packages shall not be supplied by ESOC). If a file has been compressed before transmission to the PI, then the TargetSpec filename shall be appended with a "Z" character.

It should be noted that the throughput benefits of using the ZIP option cannot be accurately assessed at present, as the degree of compression depends greatly upon the content of the data being compressed

7.1.3.10 MissionFormatType group

See Appendix A for valid mission specific format details^{DCR325}.

7.1.3.11 DataInfoType group

The format info group contains the following fields:

Field	XML type	Description
(field deleted ^{DCR 155})		
earliestStart (optional)	xsd:dateTime	Earliest time that the request can be submitted to the DAS.

7.1.3.12 DataItem group

The data item group contains the following fields:

Field	XML type	Description
DataType	DataType	Type of data to request. The permitted data types are defined in Appendix A ^{DCR 065} .
DataSource	xsd:string	The permitted data source mnemonics are defined in Appendix A. Typically a data source is a particular APID, or auxiliary data source.
CatalogueRequest	xsd:boolean	Boolean used to indicate whether the request is for catalogue information or actual data. ^{DCR 155}
Keyword (0 to n)	RequestKeywordValue	Optional keywords for a request. Can have multiple keywords specified, each keyword may also be specified multiple times ^{DCR 006}
OnEvent (0 or 1)	EventValue	Optional event for the request. Note: Currently not supported ^{DCR 019}
filter (0 to 1)	FilterExpression	Optional filter to apply to the request.

Partial Catalogues

The above values cover the requesting of data from all data streams with the exception of the partial catalogue. In this case, an asterisk (*) is entered in either the DataSource or the DataType field, and the PARTIAL.CAT data set is produced.

7.1.3.13 RequestKeywordValue group

The request keyword group can contain one of the following fields:

Field	XML type	Description
SampleRate	xsd:positiveInteger	This option indicates that following the first entry after filter start time (or the first packet if no filter) in the specified data stream, every N th entry is delivered, up to the filter end time. The default value is a sample rate equal to 1.

		<p>The TM packets will be retrieved from four different datastreams: VC0 Real Time, VC0 Playback, VC1 Real Time and VC1 Playback.</p> <p>The solution for applying the sampling rate is the following. Skip each n records in the individual history files and then merge these packets together.</p> <p>So for example if there is a history file containing the same TM data type within datastream_1 and within datastream_2, and if the sampling = 'n', then one every 'n' packets are retrieved from each of the history files in question and the result is merged.^{DCR 010}</p>
VolumeSize	xsd:positiveInteger	<p>This option specifies the maximum quantity of data that the PI wishes to be delivered in a single file. The rationale for having this option is so that a PI can more carefully control his permitted quota for on-line data delivery. The default value is the Account's daily quota.</p> <p>The value is the maximum number of bytes specified in bytes (note, NOT Kbytes or Mbytes). If this number would result in the maximum quota for the day for that Account being exceeded, then an error is returned immediately.</p> <p>In the situation where both a filter end time and VolumeSize^{DCR206} options are specified, then the data delivered will be up to the point of whichever is reached first. For example, if the end time value was 14:00:00, the VolumeSize^{DCR206} value equalled 30000 and the experiment packet time stamped 12:37:45 made the resultant file delivered 30255 bytes, then the delivery would stop at that point and would not continue until the last packet before 14:00:00.</p> <p>Note that the limits on daily data quantities apply to the data before it has been optionally 'ZIPped' for transmission over the network (see next option).</p> <p>The maximum value for this keyword is 2147483647.^{DCR165}</p>

7.1.3.14 EventValue group

The event value group can contain one of the following fields:

Field	XML type	Description
Volume ^{DCR206}	xsd:positiveInteger	This option indicates that the request

		should not return until at least the specified amount of data is available. The value is specified in bytes. Note: Currently not supported ^{DCR 019}
--	--	--

7.1.3.15 FilterExpression group

The filter expression groups allow the request to narrow down the returned data using mathematical operators such less than, greater than, equals etc. It also allows these simple filters to be combined using AND, OR, and NOT operations.

These operations are combined together is a tree notation to give precedence.

The filter expression group can contain one of the following fields:

Field	XML type	Description
unary	UnaryNodeType	Used with a unary NOT operation to negate the expression tree contained in this node.
Binary	BinaryNodeType	Used to combine two distinct expression trees.
Leaf	LeafNodeType	Represents a simple filter such as ErtTime >= 19:00:00

7.1.3.16 UnaryNodeType group

The unary node group can contain one of the following fields:

Field	XML type	Description
unary	UnaryNodeType	See section 7.1.3.15.
binary	BinaryNodeType	See section 7.1.3.15.
leaf	LeafNodeType	See section 7.1.3.15.

The unary node type has an attribute containing the unary operation to use:

Attribute	XML type	Description
operation	xsd:string	Must contain the value 'OP_NOT'.

7.1.3.17 BinaryNodeType group

The binary node group the following fields:

Field	XML type	Description
lhs	FilterExpression	The left hand side of the binary operation. See section 7.1.3.15.
rhs	FilterExpression	The right hand side of the binary operation. See section 7.1.3.15.

The binary node type has an attribute containing the binary operation to use:

Attribute	XML type	Description
operation	xsd:string	Must contain the value 'OP_AND' or 'OP_OR'.

7.1.3.18 LeafNodeType group

The leaf node group the following field:

Field	XML type	Description
ValuePair	FilterKeywordValue	The filter keyword value pair contains a filterable keyword and a value, and is compared using the leaf operation attribute.

The leaf node type has an attribute containing the leaf operation to use:

Attribute	XML type	Description
Operation	xsd:string	Must contain one of the following value: <ul style="list-style-type: none"> • 'OP_GT' • 'OP_LT' • 'OP_EQ' • 'OP_GTE' • 'OP_LTE'

7.1.3.19 FilterKeywordValue group

The filter keyword group is used to represent filterable keywords. It should be noted that these are distinct from other keywords such as SampleRate which cannot be filtered on ^{DCR206}.

This group can contain one of the following fields: ^{DCR 001, 005.}

Field	XML type	Description
SourcePktsGenTime	MultiTime	S/C Packet generation time = OBT converted into UTC. Applies only to TM packet data.
S2KpktsGenTime	MultiTime	SCOS-2000 (MCS) packet generation time (=archiving time on the MCS of this TM packet) (Applies only to TM packet data with the restriction that this keyword cannot be used for retrieving data which are saved in archive files that have been split from the main online archive) ^{DCR270}
Type	xsd:positiveInteger	Packet Type Applies only to TM packet data. If omitted from a TM packet request, an implicit wildcard is assumed (i.e. Type = *). ^{DCR146}
SubType	xsd:positiveInteger	Packet sub-type

		Applies only to TM packet data. If omitted from a TM packet request, an implicit wildcard is assumed (i.e. SubType = *). DCR146
P1Val	xsd:positiveInteger	Packet SID-1 value Applies only to TM packet data. If omitted from a TM packet request, an implicit wildcard is assumed (i.e. P1Val = *). DCR146
P2Val	xsd:positiveInteger	Packet SID-2 value Applies only to TM packet data. If omitted from a TM packet request, an implicit wildcard is assumed (i.e. P2Val = *). DCR146
ExecutionTime	MultiTime	The TC execution time (**) Applies only to TC packet data.
UplinkTime	MultiTime	The TC execution time (**) Applies only to TC packet data.
Name	xsd:string	The name of an auxiliary file. Applies only to Aux file data.
TimeSpan ^{DCR 009}	MultiTime	Start of validity time associated to an AUX file Applicable only to flight dynamics Rosetta and Mars Express attitude files and Mars Express Orbit files. Example of such a request is given below (*)
Release	xsd:string	The Release of a file. Applied only to Aux file. If the value is blank then denotes latest release
Issue	xsd: string ^{DCR206}	The Issue of a file. ^{DCR159} Applied only to Aux file. If the value is blank then denotes latest issue.

(*) Here is given an example of request of flight dynamics Attitude files with
TimeSpan^{DCR222}.

Assuming that the MCS Archive contains the following flight dyn. Attitude files:^{DCR320}

1. ATNM_FDSddd_DAP030108112233_00001.MEX
with 030108112233 = YYMMDDhhmmss (see Appendix H of the DDID)
2. ATNM_FDSddd_DAP030109112233_00001.MEX
3. ATNM_FDSddd_DAP030110112233_00001.MEX
4. ATNM_FDSddd_DAP030111112233_00001.MEX
5. ATNM_FDSddd_DAP030112112233_00001.MEX

If the user requests the following data:

DataSource = ATNM (corresponds to ADID = EMEXATNM) with

TimeSpan > 2003-01-08T20:00:00.000 and

TimeSpan < 2003-01-11T20:00:00.000^{DCR222}

When doing a TimeSpan^{DCR222} search, the GDDS will return all files that are valid (even if only for one second) within the given time range. In the above example, the files numbered (1) (2), (3) and (4) will be returned into a gzipped UNIX tar archive using the filename defined in the user's request (the usual extension of such a file is "tar.gz").^{DCR133}

(**) TC Execution Time and TC Uplink Time Filter Keywords^{DCR274}

The DDS users could see a small inconsistency between the Uplink and Execution Times which are part of the DDS header of the returned TC packet with those times which were specified in the DDS request (i.e. the filtering keywords of the DDS requests). This should not affect the use of the DDS. Nevertheless it is recommended to request the TC packets based on the "Execution time".

Further clarification is given here:

The first 16 bytes of a DDS CMD header contain the UplinkTime and ExecutionTime of the following CMD packet.

If a request is made for a packet from the command history archive specifying the UplinkTime to microsecond precision, the UplinkTime part of the DDS header will often contain a different time to that in the request. The same also applies to request based on ExecutionTime.

We would like to explain here the reason for this "small" inconsistency in the returned DDS response. The first thing to understand is that there are 7 different times associated with a SCOS-2000 telecommand (TC):

Specified Release Time

Specified Uplink Time

Specified Execution Time

Actual Uplink Time (updated after command verification)

Actual Execution Time (updated after command verification)

Packet Filing Time (primary filing key of the SCOS-2000 TC history file, initialised to filing time of the packet which is also relatively closed to the "Uplink time")

Packet Creation Time (secondary filing key of the SCOS-2000 TC history file, initialised to specified execution time)

The only feasible way for the DDS to retrieve packets from the SCOS-2000 archive is based on either the primary or secondary key of the TC history files. These values are "filing time of the packet" and "specified execution time", respectively which are not exactly the same as either Uplink Time or Execution Time, but in practice, not far off.

Each telecommand (TC) packet returned by the DDS contains a field in its header for the Uplink Time and for the Execution Time. These are the actual values for the command, and correspond to the values viewed in the Telecommand History Display; but neither of these correspond exactly to the value of the primary or secondary key for the corresponding TC packet, but in practice, not far off

The DDS users could see a small inconsistency between the Uplink and Execution Times which are part of the DDS header of the returned TC packet with those filtering keywords times which were specified in the DDS request. This should not affect the use of the DDS.

Nevertheless it is recommended to request the TC packets based on the "specified Execution time".

7.1.3.20 MultiTime group

The multi-time group is used to hold one of the different time formats that can be used. The group allows the interface to accept times without date components.

This group can contain one of the following fields:

Field	XML type	Description
a_dateTime	xsd:dateTime	See section 7.1.3.21 for examples.
(deleted)		DCR171
(deleted)		DCR171
a_duration	xsd:duration	See section 7.1.3.21 for examples.

Notes:

- The hyphens (-), colons (:), letter "T" and letter "Z" are used as specific sub-field separators. All sub-fields must contain leading zeros as necessary.
- (deleted) ^{DCR171}
- (deleted) ^{DCR171}
- The intervening Date-Time separator (T) is required if both the date and time are specified. ^{DCR171}
- It is not permitted to omit sub-fields of the date or time specification.
- (deleted) ^{DCR171}
(deleted) ^{DCR171}

7.1.3.21 XML built in types

This section briefly details the XML built in types used above. For a definitive guide refer to reference document R13.

7.1.3.21.1 xsd:dateTime

The time specification for the XML xsd:dateTime type follows the CCSDS Time Codes Format Standard (see R-6). The ASCII Time Code A format is used, this has the following format:

YYYY-MM-DDThh:mm:ssZ

Where each character is an ASCII character, which have the following meanings:

YYYY	The year with possible values 0001-9999
MM	The month with possible values 01-12
DD	The day of the month with possible values 01-31 (29-31 depends on month)
T	Date-Time separator, always the ASCII character "T"
hh	The hour with possible values 00-23

mm	The minute with possible values 00-59
ss	The second with possible values 00-59
Z	A mandatory terminator, always the ASCII character "Z"

7.1.3.21.2 xsd:boolean

The Boolean type is used for specifying either true or false values. It will not permit any other values.

Possible values are:

Value	Description
true	Boolean value true.
false	Boolean value false.

7.1.3.21.3 xsd:nonNegativeInteger

The non-negative integer type allows only non-negative values. Therefore values must be greater than or equal to 0.

7.1.3.21.4 xsd:positiveInteger

The positive integer type is a restriction on the non-negative integer type in that it cannot be zero. Therefore values must be greater than or equal to 1.

7.1.3.21.5 xsd:string

The string type represents character strings in XML. The value space of string is the set of finite-length sequences of characters.

7.1.3.21.6 xsd:duration

The duration type represents a duration of time XML. For a full description, see the following page on the World Wide Web Consortium web site:
<http://www.w3.org/TR/xmlschema-2/#duration>.^{DCR171}

7.1.3.22 File Format for ASCII based on-line FTP requests

For ASCII FTP requests an XML (XML, see R-11) syntax is used. The XML document has an associated XML schema (XSD), (Appendix I – see A-7) that enforces the expected structure and content of the XML document. The schema is also defined in XML and as such can be used by automated tools to validate DDS data requests. The advantage of using XML/XSD over a fixed position data format or other proprietary formats is that the values are intuitively understandable and self documenting to a human reader as they are written in pseudo-English. XML also allows any amount of white space (space, carriage return, line-feed, tab, vertical tab) between any of the language elements, along with comments, therefore the elements can be laid out clearly and is easily human or machine interpretable.⁰⁸⁸

A password will be required to make the request to the DDS. The password required for FTP transfers will be different to web based requests.⁰⁸⁸

7.1.4 Example

The following outlines the information for a valid request for data:^{DCR 066DCR322}

Group	Field	Value
User info	Username	ALICE
	FTP Password	confidential
Delivery info	FTP filename	simpleTLMdata
	FTP directory	<use default>
Request options	Is a catalog ue?	False
	Compression	Zip
	SFDU data?	False
Data request	Type	TM
	Source	APID 1966
	Sample rate	10
	Max amount	none
	Start time	12:00Z
	End time	19:00Z

DCR130

In the web interface the user is presented with a set pages that allow them to fill out a form that makes the request.

The ASCII format for the same request would look like the following:^{DCR088 DCR021 DCR322}

```
<?xml version="1.0"?>
<onlineRequest
  xmlns:xsi="http://www.w3.org/2001/XMLSchema-instance"
  xsi:noNamespaceSchemaLocation='GDDSRequest.xsd'
  userRequestId="20020101GDDSRequestExample">

  <general>
    <comment>
      Example XML file for a simple TLM data request with FTP delivery.

      This example is made for the user 'PI', and the telemetry data
      will be delivered by FTP to the default FTP directory of 'PI',
      using the filename 'simpleTLMdata'. ZIP compression is requested,
      but the data will not be delivered in SFDU format.

      The request will not be processed before 2002-01-01T20:00:00Z,
      and the telemetry requested is for APID=1966, with an on-board time
      betweenDCR321 2002-01-01T12:00:00Z and 2002-01-01T19:00:00Z.
    </comment>

    <userInfo>
      <username>RO_ALICE</username>
      <FTPpassword>confidential</FTPpassword>
    </userInfo>

    <destInfo>
      <FTP>
```

```

    <filename>simpleTLMdata</filename>
    <directory/>
    </FTP>
  </destInfo>

  <formatInfo>
    <compression>ZIP</compression>
    <SFDUrequired>>false</SFDUrequired>
  </formatInfo>

  <dataInfo>
    <earliestStart>2002-01-01T20:00:00Z</earliestStart>
  </dataInfo>
</general>

<item>
  <dataType>TLM</dataType>
  <dataSource>1966</dataSource>
  <catalogueRequest>>false</catalogueRequest>

  <keyword>
    <SampleRate>10</SampleRate>
  </keyword>

  <filter>
    <bin operation="OP_AND">
      <lhs>
        <leaf operation="OP_GTE">
          <valuePair>
            <SourcePktsGenTime>
              <a_dateTime>2002-01-01T12:00:00Z</a_dateTime>
            </SourcePktsGenTime>
          </valuePair>
        </leaf>
      </lhs>
      <rhs>
        <leaf operation="OP_LTE">
          <valuePair>
            <SourcePktsGenTime>
              <a_dateTime>2002-01-01T19:00:00Z</a_dateTime>
            </SourcePktsGenTime>
          </valuePair>
        </leaf>
      </rhs>
    </bin>
  </filter>
</item>
</onlineRequest>

```

DCR123

From this request, the DDS would transfer in return one zip file the data covering the period 12:00 to 19:00 on 1st January 2002 for APID 1966 with the file name of simpleTLMdata.
DCR171

7.2 Response to On-line Data Request

7.2.1 Data Item Characteristics

This data item is sent in response to the On-line Data Request defined in section 7.1 – there is one response for each request.

There are basically two types of response:

- Response to successful request (defined in sections 7.2-7.9)
- Response to unsuccessful request (defined in section 7.10)

A response to a successful request for data shall be in three parts within a single file.

- The acknowledgement of the request (defined in section 7.3)
- The catalogue entry for the data being requested (defined in section 7.4)
- The requested data itself (defined in sections 7.5-7.9)

The requested data can be one of 3 types.

- Telemetry (defined in section 7.6)
- Auxiliary data (defined in section 0)
- Catalogue data (defined in section 7.9)

7.2.2 Header Records

The SFDU shown in section 7.2.4 shows an SFDU which reflects the overall structure of a successful response.

The first two parts of the reply (acknowledgement and catalogue information) are each in a separate Label-Value-Object (LVO), and the requested data is in a third LVO.

It is built using the simplest SFDU packaging technique, Envelope Packaging. The envelope is an "outer" LVO with Class ID = Z (meaning the VALUE field can contain LVOs with any Class Identifier); and an Authority and Description Identifier (ADID) = CCSD0001 (meaning envelope packaging). This LVO contains the three components mentioned above, namely:

- An LVO with Class ID = V carrying an Acknowledgement, which contains a detailed breakdown of the original request and the response status
- An LVO with Class ID = K containing a Catalogue Entry for the requested data
- An LVO with Class ID = I containing the requested Data set itself

All the LVOs shall be delimited by ASCII length (i.e. LVOs with Version Identifier = 3 and Delimitation Identifier = B^{DCR 032} in their LABEL). The lengths of each of the LVOs shall not be fixed as it shall depend upon the volume of data transferred, which in turn depends upon what the PI requests. The actual length to be inserted in the LVO LABELs shall only be known after the VALUE fields have been generated by the system.

7.2.3 Data Records

The reader is referred to the following sections.

- Section 7.3 for the structure of the Acknowledgement
- Section 7.4 for the structure of the Catalogue Entry
- Section 7.5 for the structure of the Data itself

7.2.4 Example

The ADIDs shown below are illustrative, and the Control Authority based at ESOC may assign different values from these examples.

L	CCSD Z 0001	SFDU Label	
V	L	EROS V D005	Label for acknowledgement data
	V	Details of request and response status	Acknowledgement
	L	EROS K D004	Label for catalogue data
	V	Catalogue/ID information for the requested data set	Catalogue data
	L	EROS I T334	Label for requested data
	V	Requested data set (N telemetry packets)	Requested application data (APID 820 = Process ID 51, Category 4 telemetry in this example)

7.3 Acknowledgement

7.3.1 Data Item Characteristics

The acknowledgement constitutes the VALUE field of the Class V LVO. The VALUE field shall be expressed in XML/XSD (XML, see section 7.1.3.22, and R11).⁰⁸⁸

The information contained in the Acknowledgement is as follows:

- Details of the original on-line data request, including: options specified; the data source and type specified; the full target file specification.
- Date and time at which the request was processed by the DDS.
- Production information indicating the environment that this SFDU was created upon, including: computer, operating system and its version, SFDU generation software version, distribution method, etc;
- An error message string (this shall contain the string "NO ERROR" for nominal processing with no errors).

If there is an error in the target file specification supplied in the request file, the DDS will inform the PI of the error only by adding an error entry to the current Request Log. No response file will be sent back in this case.^{DCR160}

7.3.2 Header Records

The reader is referred to section 7.2 for the overall structure of the response message.

7.3.3 Data Records

Each request is made up of a single group:

Field	XML type	Description
onlineAck	OnlineAcknowledgementType	Defines all the required information for a single DDS request acknowledgement.

7.3.3.1 OnlineAcknowledgementType group

The acknowledgement type contains the following fields:

Field	XML type	Description
general	RequestInfoType	This defines the PI account, delivery information, and format options.
ackInfo	AcknowledgementInfoType	Contains general acknowledgement information.
ackItem (1 to n)	AcknowledgementItemType	Contains a particular acknowledgement for a particular data item request. Matches each item in the data requests.

The group also contains the following attributes:

Attribute	XML type	Description
-----------	----------	-------------

userRequestId	xsd:string	Optional attribute that a PI can use to identify a request. The DDS gets this string from the corresponding request.
---------------	------------	--

7.3.3.2 AcknowledgementInfoType

The data item group contains the following fields:

Field	XML type	Description
actualStart	xsd:dateTime	The time that the DDS actually processed the request.
operatingHardware	xsd:string	The hardware platform of the DDS.
operatingSoftware	xsd:string	The software platform of the DDS.
DDSversion	xsd:string	The version of the DDS.
ErrorMessage	xsd:string	Error message.

7.3.3.3 AcknowledgementItemType

The data item group contains the following fields:

Field	XML type	Description
actualVolume	Xsd:nonNegativeInteger DCR139	The actual delivered data size.
dataRequest	DataItemType	This is the data request that this acknowledgement matches.

7.3.4 Example

The acknowledgement to the request example in section 7.1.4 ^{DCR 068} might be as follows.

```
<?xml version="1.0"?>
<onlineAck xmlns:xsi="http://www.w3.org/2001/XMLSchema-instance"
  xsi:noNamespaceSchemaLocation='GDDSacknowledgement.xsd'
  userRequestId="19991020myrqst1">
  <general>
    <comment>
      Example XML file for an acknowledgement from the GDDS server for
      the request 'GDDSRequestExample.xml'.

      18734 bytes of data were successfully delivered using the requested
      options.
    </comment>

    <userInfo>
      <username>PI</username>
      <FTPpassword></FTPpassword>
    </userInfo>

    <destInfo>
      <FTP>
        <filename>simpleTLMdataZ</filename>
        <directory/>
      </FTP>
    </destInfo>
  </general>
</onlineAck>
```

```
<formatInfo>
  <compression>ZIP</compression>
  <SFDUrequired>>false</SFDUrequired>
</formatInfo>

<dataInfo>
  <earliestStart>2000-01-01T00:00:00Z</earliestStart>
</dataInfo>
</general>

<ackInfo>
  <actualStart>2000-01-01T00:02:07Z</actualStart>
  <operatingHardware>SUNW,Sun-Blade-100</operatingHardware>
  <operatingSoftware>SunOS 5.8</operatingSoftware>
  <DDSversion>GDDS 1.2.0</DDSversion>
  <errorMessage>NO ERROR</errorMessage>
</ackInfo>

<ackItem>
  <actualVolume>18734</actualVolume>

  <dataRequest>
    <dataType>TLM</dataType>
    <dataSource>1966</dataSource>
    <catalogueRequest>>false</catalogueRequest>

    <keyword>
      <SampleRate>10</SampleRate>
    </keyword>

    <filter>
      <bin operation="OP_AND">
        <lhs>
          <leaf operation="OP_GTE">
            <valuePair>
              <SourcePktsGenTime>
                <a_dateTime>2002-01-01T12:00:00Z</a_dateTime>
              </SourcePktsGenTime>
            </valuePair>
          </leaf>
        </lhs>
        <rhs>
          <leaf operation="OP_LTE">
            <valuePair>
              <SourcePktsGenTime>
                <a_dateTime>2002-01-01T 19: 00:00Z</a_dateTime>
              </SourcePktsGenTime>
            </valuePair>
          </leaf>
        </rhs>
      </bin>
    </filter>
  </dataRequest>
</ackItem>
</onlineAck>
```

DCR123, DCR193

7.4 Catalogue Entry

7.4.1 Data Item Characteristics

The catalogue entry is the VALUE field of the Class K LVO. This contains information specific to the actual data transferred; obviously this can be different to the requested data depending upon what time stamped telemetry frames are available etc. The entry uses the same XML/XSD language as for the acknowledgement, and contains the following information:

- The data source and data type
- The ADID of the data description for the particular packets being transferred
- The time stamp of the earliest packet in the requested data set (if applicable)
- The time stamp of the latest packet in the requested data set (if applicable)
- The filename, creation time and version of the auxiliary file (if applicable)
- The number of items that are being transferred in the requested data set

7.4.2 Header Records

The reader is referred to section 7.2 for the overall structure of the response message.

7.4.3 Data Records

Each catalogue is made up of a single group that contains one or more catalogue entries:

Field	XML type	Description
catalogue	CatalogueType	Contains one or more catalogue entries.

The catalogue entries are grouped in a catalogue so that many catalogue entries can be supplied in the same LVO value field when a Master Catalogue is requested (see later).

7.4.3.1 CatalogueType group

The catalogue type contains the following fields:

Field	XML type	Description
dataType	DataType	See Appendix A.
dataSource	xsd:string	See Appendix A.
ADID	xsd:string	Eight ASCII characters, e.g. EROST334, see Appendix A
keyword (0 to n)	CatalogueKeywordValue	One or more keywords that contain catalogue information depending on the dataType field.

7.4.3.2 CatalogueKeywordValue group

The catalogue keyword value group is composed of one, and only one, of the following fields:

Field	XML type	Type applies to	Description
SourcePktsGenStartTime	MultiTime ^{DCR 200, DCR201}	TM	The time of the first packet in the data (for requests made using the keyword: SourcePktsGenTime).
SourcePktsGenEndTime	MultiTime ^{DCR 200, DCR201}	TM	The time of the last packet in the data (for requests made using the keyword: SourcePktsGenTime).
S2KPktsGenStartTime	MultiTime ^{DCR 200, DCR201}	TM	The time of the first packet in the data (for requests made using the keyword: S2KPktsGenTime).
S2KPktsGenEndTime	MultiTime ^{DCR 200, DCR201}	TM	The time of the last packet in the data (for requests made using the keyword: S2KPktsGenTime).
earliestPacketTime	xsd:dateTime	TM, TC	The time of the first packet in the data.
latestPacketTime	xsd:dateTime	TM, TC	The time of the last packet in the data.
sampleRate	xsd:positiveInteger	TM, TC	The sample rate of the data.
SampleSize ^{DCR131}	xsd:nonNegativeInteger	All	The number of elements in the data.
filename	xsd:string	Aux	Filename of auxiliary file.
creationTime	xsd:dateTime	Aux	Creation time of auxiliary file.
version	xsd:string	Aux	Version of auxiliary file.

7.4.4 Example

The catalogue entry corresponding to the request example in section 7.1.3.22 might be as follows.

```
<?xml version="1.0"?>
-- Example XML file for a TLM catalogue.

    The catalogue contains only one data source (APID=1966), with
    the first packet at 2000-01-01T18:00:33Z and the last packet
    at 2000-01-01T18:59:21Z.

-->
<catalogue xmlns:xsi="http://www.w3.org/2001/XMLSchema-instance"
    xsi:noNamespaceSchemaLocation='GDDSCatalogue.xsd'>
  <catEntry>
    <dataType>TLM</dataType>
    <dataSource>1966</dataSource>
    <ADID>EROST7AE</ADID>

    <keyword>
      <SourcePktsGenStartTime>
        <a_dateTime>2000-01-01T18:00:33Z</a_dateTime>
      </SourcePktsGenStartTime>
    </keyword>
```

```
<keyword>
  <SourcePktsGenEndTime>
    <a_dateTime>2000-01-01T18:59:21Z</a_dateTime>
  </SourcePktsGenEndTime>
</keyword>
<keyword>
  <SampleRate>10</SampleRate>
</keyword>
<keyword>
  <SampleSize>1202</SampleSize>
</keyword>
</catEntry>
</catalogue>
```

DCR123, DCR202

7.5 On-line Data

7.5.1 Data Item Characteristics

Generally dependent on selection of SFDU format in the request^{DCR 025}

- If SFDU selected, In each case the requested data set constitutes the VALUE field of the Class I LVO.
- If SFDU not selected the dataset constitutes the unformatted data only

A PI can request data from four sources: telemetry data, telecommand data, auxiliary data and catalogue data. Data from all four sources are requested in the same manner, i.e. with a request from the Web interface.^{DCR323}

7.5.2 Header Records

The reader is referred to section 7.2 for the overall structure of the response message.

7.5.3 Data Records

The reader is referred to the following sections.

- Section 7.6 for Telemetry Data
- Section 7.7 for Command History Data
- Section 7.8 for Auxiliary Data
- Section 7.9 for Catalogue Data

7.5.4 Example

The reader is referred to the following sections.

- Section 7.6 for Telemetry Data
- Section 7.7 for Command History Data
- Section 7.8 for Auxiliary Data
- Section 7.9 for Catalogue Data

7.6 Telemetry Data

7.6.1 Data Item Characteristics

Requested telemetry data shall appear as a set of unsegmented experiment or housekeeping packets with a given ADID and arranged in time ascending order. The ADID specified in the label of the delivered Class I LVO shall point to the data description of one complete packet for the particular data source/type. The number of these packets within the Class I LVO value field is indicated by the "NUMBER_OF_PACKETS" parameter in the catalogue entry (the accompanying Class K LVO) for this transfer of data.

The experiment packets on-board the spacecraft are split into separate fixed length blocks and formatted into transfer frames for downlink to the ground and transfer to ESOC. These separate frames are then reconstituted back into complete experiment packets by the RMCS/MEMCS at ESOC and the complete experiment packets are delivered to the PIs, both for the on-line and off-line delivery formats.

The experiment packets will be timestamped with the Spacecraft Event Time (SCET). The SCET is the calibrated time of generation of the first bit in the associated packet.

The contents of each reconstituted packet of experiment data will be unprocessed, although there will be a small header attached to the beginning of each packet (the DDS Packet Header) described below.

7.6.2 Header Records

The DDS Packet Header for Telemetry Packets is an 18-octet header attached to the beginning of each packet. This is necessary to include the SCET timestamp, ground station received from, etc. This information is necessary either for the science community member to identify the source of the data packet or for ESOC to identify the source of anomalies and errors. For compactness this header does not use PVL to express the information in the header, but a bit and byte packed fixed format. The format for the header is shown below.⁰³⁹

Octet	Bits	Field	Type	Description
0-7		SCET	Time format (See below)	Time correlated OBT.
8-11		Packet length	32 bit integer	Number of octets within the data packet (excluding the DDS packet header)
12-13		Ground station ID	16 bit integer	0D (Hex) ESA Villafranca2 ^{DCR164} 15 (Hex) ESA Kourou 16 (Hex) NDIULite (for SVTs) ^{DCR215} 17 (Hex) ESA New Norcia 18 (Hex) ESA Cebreros 22 (Hex) NASA Goldstone (old) ^{DCR164} 67 (Hex) NASA Goldstone (new) ^{DCR305} 23 (Hex) NASA Canberra (old) ^{DCR164} 70 (Hex) NASA Canberra (new) ^{DCR305} 24 (Hex) NASA Madrid (old) ^{DCR215} 6C (Hex) NASA Madrid (new) ^{DCR336} 7F (Hex) ESA/ESOC Test Station ^{DCR120} 82 (Hex) NDIU classic (SVTs) ^{DCR215} The Goldstone/Canberra/Madrid GS ID changeover happened in the Nov/Dec 2003 timeframe. ^{DCR305}
14-15		Virtual Channel ID	16 bit integer	0 = VC0 1 = VC1
16		SLE Service	SLE Type	Identifies SLE service channel and the type of

Octet	Bits	Field	Type	Description
			(See below)	data
17		Time Quality (see below)	8 bit integer	0 = Good 1 = Inaccurate 2 = Bad

Spacecraft Event Time (SCET) ⁰³⁹

The time format used is the Sun MJT, as standard on Sun Solaris UNIX platforms. The format is two 32-bit integers. The first contains the number of seconds since 00:00, 1st January 1970 and the second integer contains the number of microseconds. The format is summarised below: ⁰³⁹

Field	Octets 0-3	Octets 4-7
Width in bits	← 32 bits →	← 32 bits →
Meaning	Seconds since epoch (00:00, 1 st January 1970)	Addition Micro-seconds from seconds in first field.

Ground Station ID ^{DCR246}

Please note that the ground station ID for the time correlation packets (i.e. APID 1966, type 190, subtype 40) is set to "0".

The reason for this is that the time correlation packets can be generated from Time Packets that are received by different groundstations and in this case there is no sensible groundstation ID value. Therefore it is set to "0".

Time Quality

The Time Quality gives an indication of the quality of the SCET.

The algorithm for deriving the SCET and the Time Quality is described in section 18.1.2.1.4. ^{DCR214}

SLE Type ⁰³⁹

An 8 bit integer value that defines the SLE service used. Values are:

	Real-Time (RT)	Real-Time Flow Control (RTFC)	Off-Line
SLC	0	4	8
MC	1	5	9
VC	2	6	10
Bad Frames	3	7	11

7.6.3 Data Records

Following the DDS Packet Header is the Telemetry Packet Data.

The overall structure of the Telemetry Packet complies with the ESA Packet Telemetry Standard (A-2).

The Rosetta / MEX / VEX ^{DCR325} telemetry packets are specialised as defined in the Rosetta/MEX Generic TM/TC ICDs (A-3 and A-10 ^{DCR325}).

Each GDDS request of TM raw packets data will be delivered to the users via a single file. The TM packets are stored in this single file in chronological order. Depending upon which time keyword was used to request the telemetry, the packets are returned sorted on either the source packets generation time (OBT converted to UTC) for Rosetta and Mars Express, or the S2K packets generation time (time the packets were received by the MCS). ^{DCR 002, DCR196}

As an example, if the following TM data is available via the GDDS:

SPID = 1200 for APID = 10, type=1, subtype=1, p1val =2

Pkt 1 with SourcePktsGenTime= 2003-02-14T01:00:00.000Z ^{DCR206}

Pkt 2 with SourcePktsGenTime= 2003-02-14T05:00:00.000Z ^{DCR206}

Pkt 3 with SourcePktsGenTime= 2003-02-14T10:00:00.000Z ^{DCR206}

SPID = 1201 for APID = 10, type=1, subtype=2, p1val =2, p2val = 3

Pkt 4 with SourcePktsGenTime= 2003-02-14T02:00:00.000Z ^{DCR206}

Pkt 5 with SourcePktsGenTime= 2003-02-14T06:00:00.000Z ^{DCR206}

SPID = 1202 for APID = 10, type=1, subtype=3, p1val =2

Pkt 6 with SourcePktsGenTime= 2003-02-14T03:00:00.000Z ^{DCR206}

SPID = 1203 for APID = 23, type=1, subtype=1, p1val =2, p2val = 3

Pkt 7 with SourcePktsGenTime= 2003-02-14T08:00:00.000Z ^{DCR206}

Note that the SPID is the SCOS Packet ID number which is an ID number internal to the Mission Control System.

If the following request is sent to the GDDS:

Raw TM data with APID = 10 from SourcePktsGenTime 2003-02-13T00:00:00.000Z to SourcePktsGenTime: 2003-02-15T00:00:00.000Z ^{DCR206}

The returned file from GDDS will contain the raw packets in the following order:

Pkt 1, Pkt 4, Pkt 6, Pkt 2, Pkt 5, Pkt 3

7.6.4 Example

Therefore, schematically the delivered data product shall look like that depicted below. Note that Telemetry Packets can vary in length.

L	CCSD Z 0001			
	L	EROS V D005		
		V	Details of request and response status	
	L	EROS K D004		
		V	Catalogue/ID information for the requested data set	
	V	L	EROS I T334	
			DDS TM Packet Header #1	Telemetry Packet #1
			DDS TM Packet Header #2	Telemetry Packet #2
			DDS TM Packet Header #3	Telemetry Packet #3
			V	DDS TM Packet Header #4
...			...	
...			...	
	DDS TM Packet Header #N	Telemetry Packet #N		

7.7 Command History Data ^{037 039}

7.7.1 Data Item Characteristics

Command History is available in two forms:

- TC Raw Packets, The encoding of this data is similar to raw telemetry packets
- TC Printout Format, in either full or brief mode according to datasource.

7.7.2 TC Raw Packets

7.7.2.1 Data Item Characteristics

Requested telecommand history packets are arranged in time ascending order. All packets for the requested time period are returned. The ADID specified in the label of the delivered Class I LVO shall point to the data description of the telecommand packets. The number of these packets within the Class I LVO value field is indicated by the "NUMBER_OF_PACKETS" parameter in the catalogue entry (the accompanying Class K LVO) for this transfer of data.

7.7.2.2 Header Records

The DDS Command Packet Header is a 30-octet header attached to the beginning of each packet. The format for the header is:

<i>Octet</i>	<i>Field</i>	<i>Type</i>	<i>Description</i>
0-7	Uplink Time	Time Format (See below)	Command uplink time. This is initially set to the time of release of the command from MCS, and later is updated with the timestamp provided in the message from the ground station, indicating the time of actual radiation from the antenna. If the command fails to be released from MCS, this field is set to the time at which the command release failed. ^{DCR216}
8-15	Execution Time	Time format (See below)	Table D Command execution time. This is set to either:) time provided by the user before release, at which the command will execute if it has been embedded within a service 11 load command (destined for the on-board queue). b) uplink time (as described above) + the one-way light propagation delay calculated at that uplink time. If the command fails to be released

			from MCS, this field is set to the time at which the command release failed. ^{DCR216}
16-17	CUV	Verification Flags (See below)	Command Uplink stage (CUV) i.e. the CLCW verification, indicating whether the command (at the transfer frame level) was successfully received by the spacecraft.
18-19	CAV (VC0)	Verification Flags (See below)	Command Acceptance stage (CAV), i.e. whether the command was successfully accepted by the appropriate application on-board. This stage is based on VC0 (Real-Time) telemetry.
20-21	CEV (VC0)	Verification Flags (See below)	Command Execution stage (CEV), i.e. whether the command successfully completed its execution on-board. This stage is based on VC0 (Real-Time) telemetry.
22-23	CAV (VC1)	Verification Flags (See below)	Command Acceptance stage (CAV), i.e. whether the command was successfully accepted by the appropriate application on-board. This stage is based on VC1 (Playback) telemetry.
24-25	CEV (VC1)	Verification Flags (See below)	Command Execution stage (CEV), i.e. whether the command successfully completed its execution on-board. This stage is based on VC1 (Playback) telemetry.
26-29	Packet Length	Integer (Unsigned 32 bit)	Number of octets in the Data Record (This excludes the DDS telecommand packet header)
30-37	Command ID	Characters	The name of the command in the database ⁰³⁷
38-45	Parent Sequence ID	Characters	The name of the command's parent sequence in the database ⁰³⁷

Octet 30 onwards is used to contain a Data Record, as defined in section 7.7.2.3.

Time Format

The time format used is the Sun MJT, as standard on Sun Solaris UNIX platforms. The format is two 32 bit integers. The first contains the number of seconds since 00:00, 1st January 1970 and the second integer the number of micro-seconds. The format is summarised below:

Field	Octets 0-3	Octets 4-7
Width in bits	← 32 bits →	← 32 bits →

Meaning	Seconds since epoch (00:00, 1 st January 1970)	Addition Microseconds from seconds in first field.
----------------	---	--

Verification Flags

Each Verification Flag type is a 16-bit word (i.e. two octets, with the first octet most significant ^{DCR220}). This 16-bit word has exactly 1 bit set*, which identifies the status of each stage according to the following masks (bit 0 being the Least Significant Bit):

- Bit 0: IDLE (indicating that the command stage window has not yet opened)
- Bit 1: PENDING (indicating the stage window has opened but no verification information has arrived)
- Bit 2: PASSED (indicating the stage was successful according to telemetry)
- Bit 3: FAILED (indicating the stage was explicitly unsuccessful according to telemetry)
- Bit 4: UNVERIFIED (indicating that no applicable telemetry was available to verify this stage, and was subsequently consolidated by the controllers)
- Bit 5: UNKNOWN (indicating that the stage window has closed with no applicable telemetry available to verify this stage)
- Bit 6: TIMED-OUT (only applicable to CUV, indicating that no response was received within the configured CUV window)
- Bit 7: SCC ONLY (indicating that the stage has no verification expression, but exists in order to ensure that the appropriate TM parameters has Status Consistency Checking disabled)
- Bit 8: ASSUMED (only applicable to CUV, indicating that a PENDING or TIMED-OUT status of CUV has been superseded due to the fact that a subsequent CAV or CEV stage has been successful).

Table D Note: Only PASSED, FAILED and UNVERIFIED statuses are final, i.e. all other stage statuses may change over the course of the command's verification. A command is deemed complete when all of its stages has a final status* A word filled with all zeros, indicates that the stage was not applicable. Either the stage was not defined in the database or verification of it was disabled prior to command release.

7.7.2.3 Data Records

Following the DDS Packet Header is the data for a single encoded Telecommand Packet as sent to the spacecraft within a transfer frame.

The structure of Rosetta / MEX telecommand packets are as defined in the Rosetta/MEX Generic TM/TC ICD (A-3).

7.7.2.4 Example

Therefore, schematically the delivered data product shall look like that depicted below. Note that Telecommand Packets can vary in length.

L	CCSD Z 0001
---	-------------

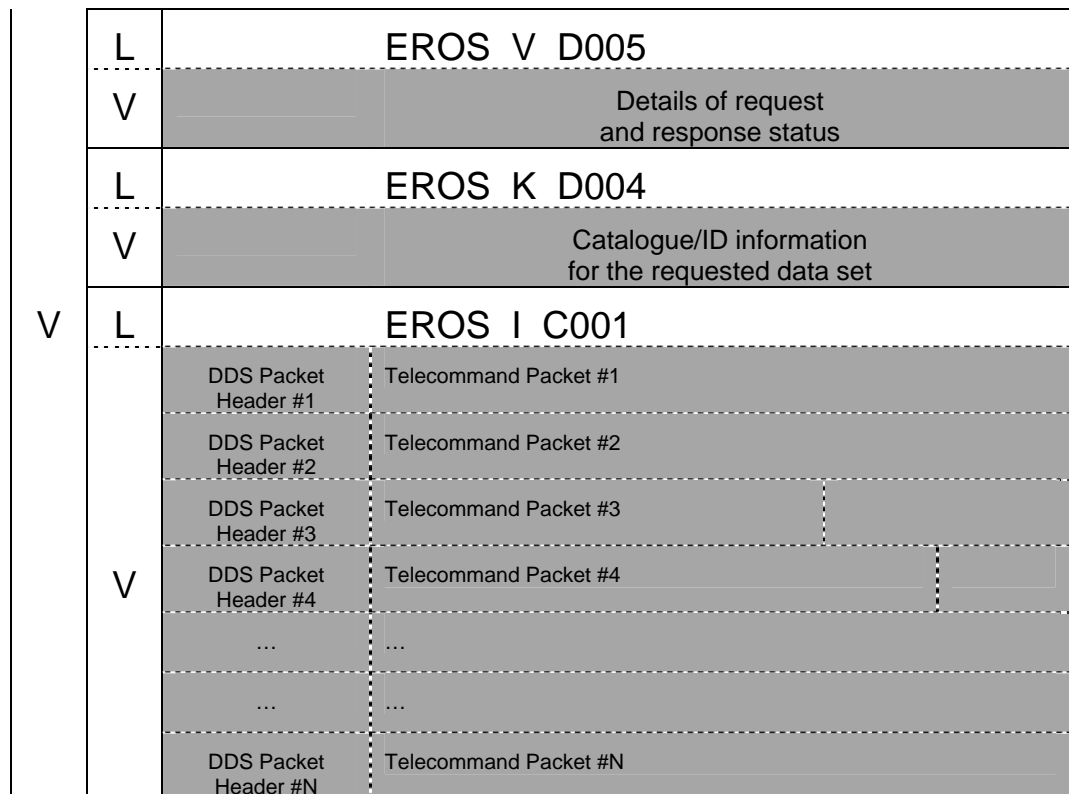

7.7.3 TC Printout

7.7.3.1 Data Item Characteristics

The data is returned in a human readable ASCII formatted file that containing telecommand history generated by the "TC History Printout" application on MCS.

It is available in two forms, selectable by datasource

- CMDPB, Brief Mode. where each line in the printout describes a single command
- CMDPF, Full Mode, in addition to the information in brief mode, an additional line in the printout describes each editable parameter of the command.

These files are designed to be human readable, so no detailed layout specification is available. The columns in the printout are described below

7.7.3.2 Columns of the Printout (Full and Brief Mode)

	Column Title	Description
1.	Name	The name of the command
2.	Description	The description of the command

23.	Task Status	<p>The status of each individual verification stage may have one of the following values:</p> <table border="0" style="margin-left: auto; margin-right: auto;"> <tr><td style="padding-right: 20px;">F</td><td>Fail</td></tr> <tr><td>U</td><td>Unverified</td></tr> <tr><td>X</td><td>Unknown</td></tr> <tr><td>P</td><td>Pending</td></tr> <tr><td>T</td><td>Time-out</td></tr> <tr><td>S</td><td>Success</td></tr> <tr><td>I</td><td>Idle</td></tr> <tr><td>A</td><td>Assumed (applicable only for CUV)</td></tr> <tr><td>D</td><td>Disabled (only applicable for Time-Tagged cmds) *</td></tr> <tr><td>Blank</td><td>N/A</td></tr> </table> <p>'ABORTED' is displayed for a service 13 encapsulated command belonging to an aborted transfer.</p> <p>'DELETED' is displayed for time-tagged commands successfully (and confirmed) deleted from the on-board queue.</p> <p>'NO LOAD' is displayed for time-tagged commands which failed to be loaded onto on-board queue.</p>		F	Fail	U	Unverified	X	Unknown	P	Pending	T	Time-out	S	Success	I	Idle	A	Assumed (applicable only for CUV)	D	Disabled (only applicable for Time-Tagged cmds) *	Blank	N/A
F	Fail																						
U	Unverified																						
X	Unknown																						
P	Pending																						
T	Time-out																						
S	Success																						
I	Idle																						
A	Assumed (applicable only for CUV)																						
D	Disabled (only applicable for Time-Tagged cmds) *																						
Blank	N/A																						
24.	Verification Status headings	R	<p>Release from SCOS-2000 to the NCTRS. Note that a failure for this stage may be caused by one of the following reasons:</p> <ul style="list-style-type: none"> • PTV NOT OK at release • PTV OK (e.g. dynamic PTV was overridden) but no TCP/IP connection between the releaser and the NCTRS was available at release time • The command was successfully released but eventually rejected by the NCTRS e.g. because the required connection to the station equipment was not available at release time. In this case an administrative message is also received from the NCTRS and logged in the HFA. 																				
		G	Ground station reception (UV 1 st stage) (CRV)																				
		T	Uplink a.k.a. radiation (UV 2 nd stage) (CSV)																				
		O	On-board reception a.k.a. transfer (3 rd UV stage, only applicable in AD mode) (CUV)																				
		A	On-board application acceptance for VC0 (CAV)																				
		C	Execution completion for VC0 (CEV)																				
		0	Previous stages belong to VC0																				
		A	On-board application acceptance for VC1 (CAV)																				
		C	Execution completion for VC1 (CEV)																				
		1	Previous stages belong to VC1																				

Table 1 – Command History Display fields description; brief mode

7.7.3.3 Columns of the Printout (Full)

Full mode shows a view of the editable parameters of the command. The display shows the commands exactly as in brief mode then in the following rows of the display it shows the parameters described in 4 columns of data.

Column	Description
Name	The name of the command parameter
Description	Command parameter description
Representation	The parameter value representation i.e. whether the value shown in the final column is raw or engineering
Radix	Only applicable for unsigned integer raw values. It can be Decimal, Hexadecimal or Octal
Value	The parameter value in the representation specified in column 2 (this is the one selected by the user to enter the parameter value either as a default in the database or when loading the task on the stack)

Table 2 – Command History Display fields description; full mode

7.7.4 Example – Brief Mode

An example of a printout in brief mode is given below. This will be SFDU encoded as an Auxiliary File

Command history display printout from time: 2002.056.12.04.19.656 to time: 2002.056.15.39.16.439
Current printout time: 2002.056.15.48.03.444 Display view mode: BRIEF Sort order: RELEASE Filter status: INACTIVE
Number of commands printed: 14

Name	Description	Sequence	Release Time	Execution Time	Sub	ST	SST	PID	11	13	C	S	D	0	1	G	B	IL	ST	FC	SSC	R	GTO	AC0	AC1-
13LAST	Accept Last Part		02.056.12.46.45	02.056.12.47.05.110	0	13	11	1			B	E	E	E	E			LU	MS	-	02B	S	SS	XX	XX
ZDM01760	Cancel Ping		02.056.12.46.45	02.056.12.47.24.102	0	134	1	1		Y	B	E	E	E	E				MS	-	162	S	PP	ABORTED	
ZDM01760	Cancel Ping		02.056.12.46.45	02.056.12.47.25.102	0	134	1	1		Y	B	E	E	E	E				MS	-	163	S	PP	ABORTED	
ZDM01760	Cancel Ping		02.056.12.46.45	02.056.12.47.26.102	0	134	1	1		Y	B	E	E	E	E				MS	-	164	S	PP	ABORTED	
ZDM01760	Cancel Ping		02.056.12.46.45	02.056.12.47.27.102	0	134	1	1		Y	B	E	E	E	E				MS	-	165	S	PP	ABORTED	
ZDM01760	Cancel Ping		02.056.12.46.45	02.056.12.47.28.102	0	134	1	1		Y	B	E	E	E	E				MS	-	166	S	PP	ABORTED	
ZDM01760	Cancel Ping		02.056.12.46.45	02.056.12.47.29.102	0	134	1	1		Y	B	E	E	E	E				MS	-	167	S	PP	ABORTED	
ZDM01760	Cancel Ping		02.056.12.46.45	02.056.12.47.30.102	0	134	1	1		Y	B	E	E	E	E				MS	-	168	S	PP	ABORTED	
ZAL19226	Multiple Acquire Dump	AROTEST8	02.056.15.38.26	02.056.15.38.46.961	0	192	26	92			A	E	E	E	E				MS	00	001	S	SST	XX	XX
ZAC00327	Modify AOCMS HK Freq	AROTEST8	02.056.15.39.04	02.056.15.39.24.563	0	3	27	11			A	E	E	E	E				MS	01	001	S	SST	XX	XX
ZRP22002	Opto 28V Switch	AROTEST8	02.056.15.39.08	02.056.15.39.28.421	0	220	2	85			A	E	E	E	E				MS	02	001	S	SST	XX	XX
ZRP22002	Opto 28V Switch	AROTEST8	02.056.15.39.11	02.056.15.39.31.098	0	220	2	85			A	E	E	E	E				MS	03	002	S	SST	XX	XX
ZRP22002	Opto 28V Switch	AROTEST8	02.056.15.39.13	02.056.15.39.33.261	0	220	2	85			A	E	E	E	E				MS	04	003	S	SST	XX	XX
ZLC00ETC	CDMS Emergency telecommander		02.056.15.39.16	02.056.15.39.36.547	0	192	128	108			A	E	E	E	E				MS	05	001	S	SST	X	X

7.8 Auxiliary Data

7.8.1 Data Item Characteristics

Auxiliary data is requested using the same mechanism as for telemetry data. The various files of auxiliary data available are also listed in Appendix A together with their corresponding data source/type mnemonics and ADID. They are referenced in the same manner as telemetry data streams, i.e. with a data source and data type mnemonic.⁰³⁸

With regard to the on-line retrieval of auxiliary data, Appendix E describes the difference between "span valid" auxiliary files⁰⁸⁷ where a packet's data is applicable from the time of that packet up to the time of the next packet in the file, and "point valid" auxiliary files⁰⁸⁷ where a packet's data is applicable only at the packet time.

The auxiliary files can be retrieved based on a given time interval.^{DCR206} If there are more than one file which are valid within this given time interval, then more than one files will be retrieved from the Archive. These files will be wrapped together and sent back to the user as one single file. The file name convention of this wrapper file is as specified by the user in his request input file.^{DCR 014, DCR 158}

The format of the catalogue entry for an auxiliary data source is the same as for the telemetry data sources. However fields which are not relevant to Auxiliary data are left blank (e.g. Sample Rate).⁰⁴⁷

The DDS does not perform any processing on the content of an auxiliary file. Only complete unprocessed files, as retrieved from the DAS, are sent to a PI.⁰⁵⁰

7.8.2 Header Records

- No header records are added to auxiliary data.^{038 048}

7.8.3 Data Records

For details of the format of the auxiliary data see Appendix E. Each of the definitions in Appendix E defines a single auxiliary data entry.^{DCR206} A number of these (depending upon the time span requested) will constitute the delivered auxiliary file.

Where multiple files are returned, they are wrapped into a Unix tar file.^{DCR206}

7.8.4 Example

The following example is for the Heliocentric S/C cruise orbit ASCII (POHA)^{037 059} file.

L	CCSD Z 0001	
V	L	EROS V D005
	V	Details of request and response status
	L	EROS K D004
	V	Catalogue/ID information for the requested data set
	L	EROS I ORHR
	V	The data contained in the Heliocentric spacecraft cruise orbit data file, in an ASCII format

7.9 Catalogue Data

7.9.1 Data Item Characteristics

7.9.1.1 Master Catalogue

As described in the earlier sections each delivery of a data set is accompanied by a catalogue entry. In order for PIs to know what data is available to be requested they must also have the capability to request availability catalogues, these are known as Master Catalogues.

A Master Catalogue request should not be confused with a single catalogue entry for a particular data source/type that is delivered with a requested data set. As described in Section 7.4, there is a catalogue entry with each data delivery (unless there is an error). This catalogue entry is for that particular data set only, and only covers the requested time span.

Further to this, each PI shall also be able to request a Master Catalogue for all the data currently available on-line from the DDS. When a PI asks for a Master Catalogue, he shall receive catalogue entries for all the available data streams. There is no restriction on the access of data for any PIs, e.g. a PI may access data both from his own instrument and that of others. The format of a Master Catalogue is simply all the individual data stream catalogues concatenated together.

To request a Master Catalogue the PI follows the same procedure as for any other data request. The data source and data type are specified with a wildcard ^{DCR 02} ^{DCR 269} Please note that for performance reason the Master Catalogue for telemetry data has been disabled.

In a request for a Master Catalogue, the StartTime and EndTime options are still valid. This means that a PI can find out what data is available from all data streams during a particular period. If these options are not supplied, then the response shall be a summary catalogue for all data streams currently available on-line. ^{DCR161} Any other options are also permitted, their meanings being the same as that stated earlier in this document.

7.9.1.2 Partial Catalogue

In addition to the Master Catalogue, a PI shall be able to request a Partial Catalogue. In order to request this, the PI enters an asterisk into either the data source or the data type field. ⁰⁸⁷

As another example, a data source of * and data type of AUX will result in the catalogue listings for all auxiliary files. ⁰³⁷

It follows that a request with data source of * and data type of * is equivalent to a Master Catalogue request.

The on-line data request options are also valid for a partial catalogue.

7.9.2 Header Records

A catalogue request, upon being successful, shall result in a file transfer back to the PI, the file having the same structure as shown in 7.2.

7.9.3 Data Records

The catalogue entries that are being delivered shall be in the VALUE field of the Class I LVO. The aggregation construct (BEGIN_OBJECT / END_OBJECT) around each single catalogue entry allows the separate catalogue entries to be distinguished.

Each catalogue entry shall have the same format as that described in Section 7.4, except the NUMBER_OF_PACKETS parameter shall be a null (empty) string). This indicates an unknown quantity of packets, as it is not possible due to performance reasons to count the number of packets available within any given time span.

The Class K LVO within the delivered SFDU shall give details of what catalogue entries have been delivered. The catalogue parameters in the Class K LVO, FIRST_PACKET_TIME and the LAST_PACKET_TIME, have no meaning in this situation and therefore shall be a null (empty) string).

7.9.4 Example

The following example is for a Partial Catalogue of all auxiliary data.

Note: The class K LVO is contains a description of the catalogue requested, and the class I LVO is used to hold a catalogue entry for each item that is in the class K catalogue description. Thus the class I LVO may contain a list of catalogues that are available for the K LVO class. The example shows such a Partial Catalogue for auxiliary data.⁰⁴⁹

L	CCSD Z 0001	
V	L	EROS V D005
	V	Details of request and response status
	L	EROS K D004
	V	Catalogue/ID information for the requested data set
	L	EROS I D008
	V	Catalogue entry for POHA.AUX
	V	Catalogue entry for POHB.AUX
	V	Catalogue entry for RENV.AUX

7.10 Error Message

7.10.1 Data Item Characteristics

The only time that the PI shall not receive an SFDU of the structure shown in 7.2, is when an error has been detected during the processing of the request. When this occurs an SFDU containing only the acknowledgement LVO (Class V LVO) shall be transferred, the structure of which is shown below.

An acknowledgement with an error message may also be returned from the monitoring process on the DDS. This monitors when requests arrive, and how long it takes to respond to them. If after a defined time-out period the PI has not received the requested data then the PI must assume that either: the DDS never received the request, system load was too great to process the request, or the requested data was lost in transfer. In this situation the data should be requested again. The overall time-out period is configurable by ESOC (in the range – - 32767 minutes); a value of 120 minutes is the default. The monitor process also monitors how many requests each PI has queued for processing by the DDS; if this is equal to 12, then any new requests shall be deleted and an error message returned immediately.

7.10.2 Header Records

See example below for the overall structure of the response message.

7.10.3 Data Records

The format of the acknowledgement LVO upon error is the same as for an error free request, although depending upon the error incurred not all the parameters can be given meaningful values.

Any value that cannot be completed correctly shall be substituted with a null (empty) string).

The ERROR_MESSAGE string shall be a suitable error message, these are listed in Appendix B.

There may be situations when all the parameters of the acknowledgement are completed correctly, but there is still an error, e.g. in the case of a PI requesting a data source/type for which there is no data available during the requested time span. In this case the ERROR_MESSAGE string would show this. If there is no error at all then the ERROR_MESSAGE parameter shall be given the value "NO ERROR".

The ERROR_MESSAGE string shall have the following formats:

"ROSETTA DDS ERROR-nn: error string" for RDDS

"MEX DDS ERROR-nn: error string" for MEDDS

Where nn is the error message number (see Appendix B).

7.10.4 Example

The example below shows the structure of an error message SFDU.

L	CCSD Z 0001		SFDU Label
	L	EROS V D005	Label for acknowledgement data
V	V	Details of request and error status	Acknowledgement

7.11 Off-line Data Delivery

7.11.1 Data Item Characteristics

The off-line data delivery system is totally separate and asynchronous to the on-line data delivery system. The PIs have no input in the process to receive data; the system is wholly controlled by ESOC. The science community members shall receive the data on a Raw Data Medium (RDM), i.e. CD-ROM for Mars Express and Venus Express^{DCR325}, only^{DCR228}.

This section assumes the chosen medium is CD-ROM^{DCR041}. Each disk shall contain the data from all data streams from all instruments and also all the auxiliary data produced by ESOC. Further to this, each disk shall contain a copy of all the data descriptions required to understand the data on the disk. This means that the data on each disk shall be wholly self-contained. Requests made using the DDS shall specify the start/stop time period of the data required. Once the request has been authorised by ESA, the CD-ROM shall be prepared.⁰⁵⁶

The CD-ROM for any single day must be delivered within 1 month of reception of the data by ESOC. This drives the logistic and delivery timeline as follows. 6 days is allowed for the auxiliary data such as orbit and attitude data to be consolidated before a master Write-Once CD-R is produced. This master Write Once CD-R is then shipped to the CD-ROM manufacturer for mastering and reproduction. The CD-ROM manufacturer will then deliver the CD-ROMs directly to the recipient science community members. During the commissioning phase of the mission, CD-ROMs will only be delivered to PIs and data centres (not co-investigators).

The strategy for Venus Express is TBD^{DCR325}.

Thereafter, during the routine phase, (Mars Express and Venus Express^{DCR325} Only – Not Rosetta^{DCR 023}) they shall be delivered to all PIs, co-Is and data centres

7.11.2 Header Records

The CD-ROM is in itself a self-describing SFDU as explained below.

7.11.3 Data Records

The data shall be accessible on the CD-ROM by two methods.

- Firstly the more conventional direct file access, i.e. each data stream shall be stored under a filename in a particular directory
- Secondly the whole of the disk may be viewed as a single logical SFDU product. The SFDU product is formed by having an EDU file in the top level directory of the disk that uses the SFDU referencing technique to logically include all the other data files and data description files on the disk into a single SFDU product.

The conventional method of accessing the data will present no problems as long as the science community member knows what he is looking for, where it is on the disk, the file naming convention etc. When he retrieves it he must already know what it actually means, e.g. the format, syntax and semantics of the data.

The SFDU approach has the advantage that nothing needs to be known about the disk in advance except the name of the top-level "index" SFDU file. From this SFDU file the science community member can find all the data on the disk, the corresponding data descriptions and via the ADIDs can link the two together. So for long-term archive access when documentation and knowledgeable people may not be available this assures the continued understanding of the data.

7.11.4 Example

The CD-ROM is shown schematically below. The conventional directory structuring is shown on the right whilst the SFDU index file in the root directory of the CD-ROM and its file reference pointers are shown on the left.

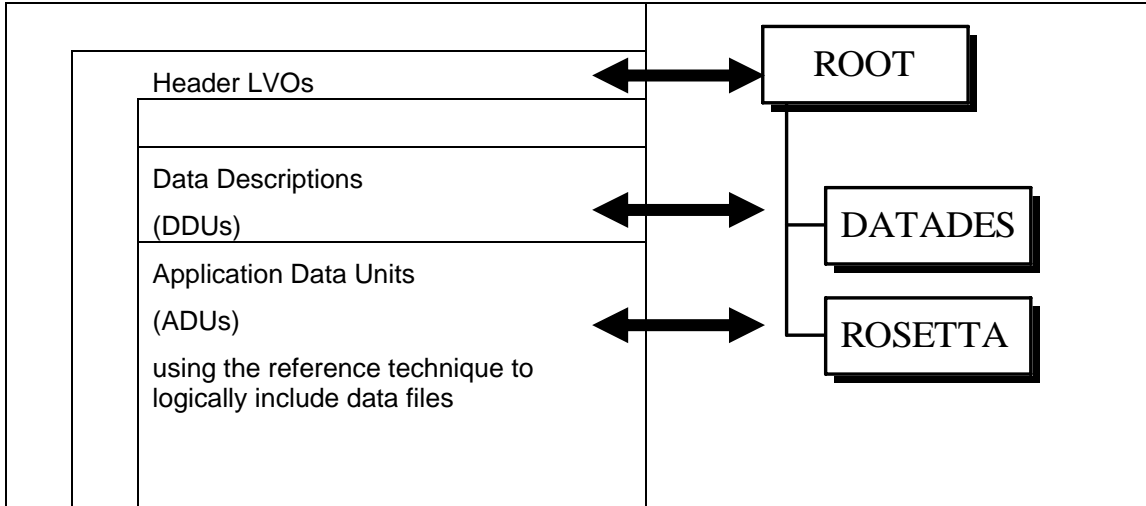

7.12 RDM (SFDU View)

7.12.1 Data Item Characteristics

The files on the RDM shall be made to look like one logical SFDU product by using a single SFDU file in the root directory that shall then use the SFDU referencing technique to logically include all the other files on the disk. In other words, this top level SFDU file describes the whole volume of data, therefore it is called a VOLDESC file. The only file name required to be known is the name of this top level SFDU file.

The general structure of the VOLDESC file is shown below. This is an EDU that contains:

1. Header LVOs which give details of the overall SFDU product, such as the volume production information, directory listing, cumulative index, etc. Each of these are items will be contained in separate LVO value fields.
2. A further EDU containing:
 - Description Data Units (DDUs)
 - Application Data Units (ADUs)

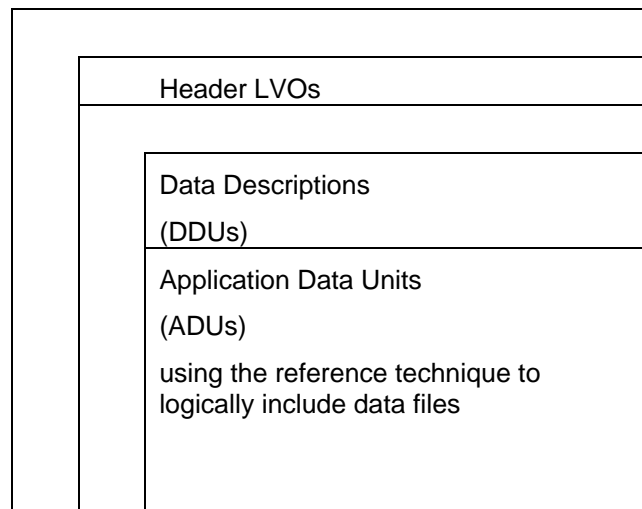

All these DDUs and ADUs use the referencing technique to point to the relevant data objects stored elsewhere on the RDM, i.e. physically external to the VOLDESC SFDU file.

7.12.2 Header Records

To demonstrate how the VOLDESC SFDU file is used for MEX, the above diagram shall gradually be expanded to include the details of each of the three areas shown (Header LVOs, Data Description Units and Application Data Units). The structure expanded in more detail is shown below.

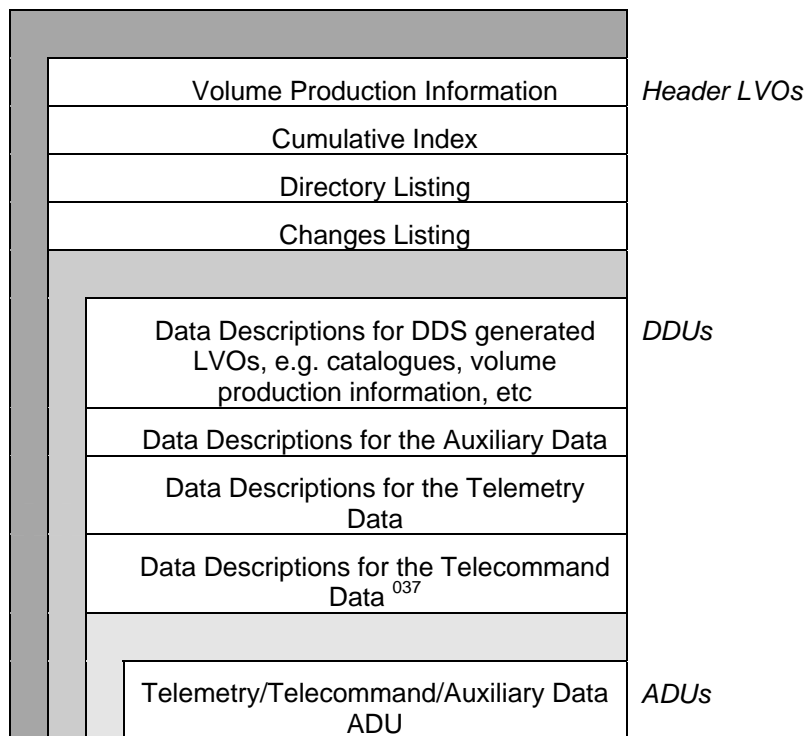

The Header LVOs consist of data that pertains to the whole SFDU product, for example, the volume production information, supplementary data such as a directory listing of the whole RDM, version and configuration information, etc. As the information in the header LVOs applies to all the data description and telemetry data, all further LVOs are at a structure level lower than the header LVOs.

The data description LVOs consists of a sequence of DDUs. There is one DDU for each data description that is supplied on the RDM. There are three categories of data descriptions.

- Those describing the data formats used by the RDM itself, e.g. the catalogue entries, the volume production information, etc
- Those that describe the format of the auxiliary data produced by ESOC, e.g. time calibration data, orbit and attitude data
- Those that describe the format of the telemetry and telecommand data from the spacecraft.

Following the header LVOs and the DDUs, there is the data itself. Each stream of data generated by the spacecraft or ESOC is packaged in an Application Data Unit (ADU), this is so that a catalogue entry giving catalogue details of the associated data file can be included within the ADU. This catalogue entry shall relate to the data file within the same ADU only.

7.12.3 Data Records

Further detail of the LVOs involved in the structure shown above is shown below.

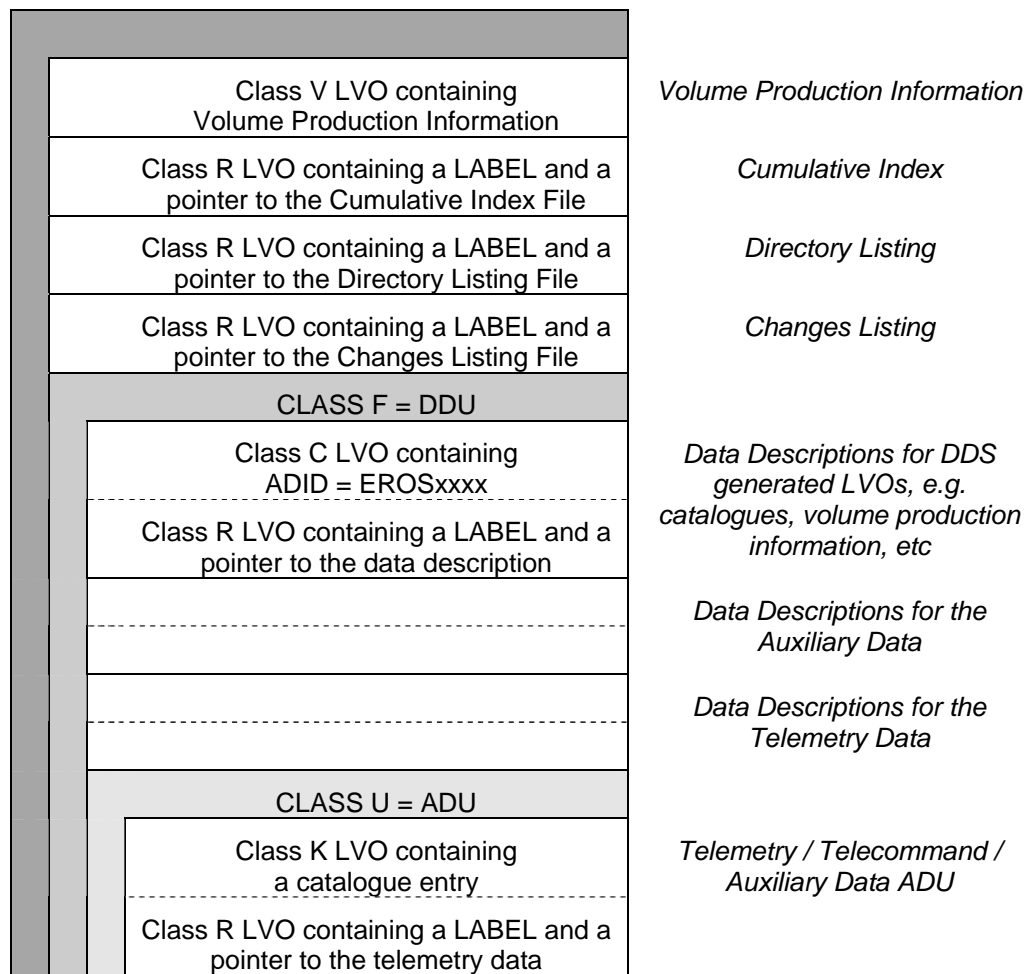

As can be seen, the VOLDESC file uses the file referencing service provided by the Class R LVO to logically include the various files in the overall SFDU. In the header LVOs, the directory structure listing and version control file are in files in the root directory of the volume, the Class R LVOs point to these files and hence they are logically included as part of the header information.

For each Data Description Unit (DDU, signified by the Class F LVO), the Class C LVO is in-line in the VOLDESC file, this LVO assigns the ADID to the data description via the ADID=EROSxxxx statement. The actual data description itself is contained in a disk file that is again logically included using the Class R referencing service.

Finally each ADU, contains in-line a Class K LVO that contains the catalogue information for the associated data in the ADU, and another Class R LVO points to the data and logically includes it in the VOLDESC SFDU product.

In the VOLDESC file there is one DDU for each data description used on the RDM, and then there is one ADU for each telemetry/auxiliary data file stored on the RDM.

7.12.4 Example

A schematic of this overall structure is shown in detail below. This figure includes the details of the statements used in the Class C and Class R LVO to provide the registration and referencing services respectively.

	Class Z ADID = CCSD0001	
	Class V ADID = EROSD006	
*	Volume Production Information	
@	Class R ADID = CCSD0003	
	REFERENCETYPE = \$CCSDS1 LABEL = CCSD3SF0000200000001 REFERENCE = 9904301A.IDX	Pointer to Cumulative Index File
#	Class R ADID = CCSD0003	
	REFERENCETYPE = \$CCSDS1 LABEL = CCSD3SF0000200000001 REFERENCE = 9904301A.LST	Pointer to Directory Listing File
+	Class R ADID = CCSD0003	
	REFERENCETYPE = \$CCSDS1 LABEL = CCSD3SF0000200000001 REFERENCE = 9904301A.LSC	Pointer to Change Listing File
	Class Z ADID = CCSD0001	
	Class F ADID = CCSD0005	
\$	Class C ADID = CCSD0004	
	ADID = EROSD002	
	Class R ADID = CCSD0003	
	REFERENCETYPE = \$CCSDS1 LABEL = CCSD3DF0000200000001 REFERENCE = DATADES/DDS_DES/990430D002.IDD	Pointer to Cumulative Index Data Description File
	Class F ADID = CCSD0005	
\$	Class C ADID = CCSD0004	
	ADID = EROST334	
	Class R ADID = CCSD0003	
	REFERENCETYPE = \$CCSDS1 LABEL = CCSD3DF0000200000001 REFERENCE = DATADES/TLM_DES/990430T334.1AD	Pointer to APID 820 Data Description File
	Class F ADID = CCSD0005	
\$	Class C ADID = CCSD0004	
	ADID = EROST364	
	Class R ADID = CCSD0003	
	REFERENCETYPE = \$CCSDS1 LABEL = CCSD3DF0000200000001 REFERENCE = DATADES/SCD_DES/990430T364.1AD	Pointer to APID 868 Data Description File
\$	More Class F LVOs defining ADIDs/descriptions for all data delivered on the ROSETTA RDMs	Pointers to other Data Description Files
%	Class U ADID = CCSD0009	
	Class U ADID = CCSD0009	
	Class K ADID = EROSD003	
	Catalogue entry for the data set referenced by the Class R LVO following this Class K LVO	
	Class R ADID = CCSD0003	
	REFERENCETYPE = \$CCSDS1 LABEL = EROS3IF0T334000000001 REFERENCE = ROSETTA/SCD/990430T334.1AR	Pointer to APID 820 Telemetry Data File
%	Class U ADID = CCSD0009	
	Class U ADID = CCSD0009	
	Class K ADID = EROSD003	
	Catalogue entry for the data set referenced by the Class R LVO following this Class K LVO	
	Class R ADID = CCSD0003	
	REFERENCETYPE = \$CCSDS1 LABEL = EROS3IF0T364000000001 REFERENCE = ROSETTA/SCD/990430T364.1AR	Pointer to APID 868 Data File
%	More Class U LVOs each containing a Class K LVO (catalogue record) and a Class R LVO which logically includes a referenced data file within this SFDU file. This is repeated for all data files on the Rosetta RDM.	Pointer to Other Data Files

Referring to the symbols at the side of the SFDU shown above, the various LVOs in the VOLDESC file have the following contents:

Class V LVO (*): This LVO contains the volume production information for the whole SFDU, and therefore applies to the total contents of the RDM. The volume production information is expressed in PVL, the valid parameters and their corresponding values are shown in the table below.

Parameter	Possible values
MISSION	ROSETTA, MEX, VEX
PREPARED_BY	"European Space Operations Centre, Robert-Bosch Strasse 5, 64293 Darmstadt, Germany"
EARLIEST_PACKET	Time of earliest telemetry packet on this RDM. CCSDS format time (YYYY-MM-DDThh:mm:ssZ) "not applicable" if only AUX ⁰⁸⁷ on this RDM.
LATEST_PACKET	Time of latest telemetry packet on this RDM. CCSDS format time (YYYY-MM-DDThh:mm:ssZ) "not applicable" if only AUX ⁰⁸⁷ on this RDM.
TOTAL_DATA_QUANTITY	Integer number of bytes of data in all files referenced by the VOLDESC file, e.g. 12345 <bytes>
COMPUTER	Quoted string
OPERATING_SYSTEM	Quoted string
DDS_SOFTWARE_VERSION	Quoted string
PRODUCTION_TIME	CCSDS format time (YYYY-MM-DDThh:mm:ssZ)

Class R LVO (@): This LVO is used to reference an ASCII encoded English text file (as indicated by the ADID=CCSD0002 (see R-9). This text file is given a Class S LABEL (meaning Supplementary Data) by the referencing Class R LVOs LABEL statement. The contents of the referenced file are the cumulative index for the RDM production. This file lists all the RDMs that have been produced over the life of the mission until the present time. It also indicates any RDMs that have been replaced by a corrected one, in the case of an erroneous RDM issue. This version index is cumulative over the whole mission.

Class R LVO (+): This LVO is used to reference an ASCII encoded English text file (as indicated by the ADID=CCSD0002; see R-9). This text file is given a Class S LABEL (meaning Supplementary Data) by the referencing Class R LVOs LABEL statement. This file will only have any content if the RDM on which it is on is a reissue or a previously issued RDM that was found to have an error. In this case, this file will list those files that are corrected for the reissue. This means the science community members know immediately if the corrected data concerns them and they should reprocess the RDM. The contents of the referenced file is in the same format as the directory listing file (see next LVO). This shall show the full filenames with the directory name and the new file size

Class R LVO (#): This LVO also references an ASCII encoded English text file (as indicated by the ADID=CCSD0002; see R-9). This text file is given a Class S LABEL (meaning Supplementary Data) by the referencing Class R LVOs LABEL statement, and the contents of the referenced file is a full directory listing of the RDM. This shall show the directory structure and list of files in each directory with the file size.

Class F LVOs (\$): There then follows a number of Class F LVOs, each of these LVOs is a Data Description Unit (DDU) and links one ADID with one data description. Nested within the Class F LVO is a Class C LVO followed by a Class R LVO. The Class C LVO has the PVL statement ADIDNAME=EROSnnnn, this defines the ADID under which the data description following shall be referenced. The Class R LVO then uses the referencing technique to point to a data description file, this file is logically included within the Class F LVO and hence is associated with the named ADID. There is one Class F (each containing one Class C and one Class R) for each data description used on the RDM.

Class U LVOs (%): The next Class U LVO contains many other Class U LVOs, these are all Application Data Units (ADUs), each of the lower level Class U LVOs contain a Class K LVO and a Class R LVO pair. The Class K LVO is the catalogue data for the corresponding data set pointed to by the Class R LVO. The Class R LVO is used to reference and hence logically include the data set file within the Class U. The LABEL statement in the Class R LVO contains an ADID that defines the data description to be used for understanding the data set. There is one nested Class U LVO for each data file that is stored on the RDM.

The Class K LVOs VALUE field is a catalogue entry, this catalogue entry is written in PVL, the valid parameters and their values are shown below. As can be seen this is the same catalogue entry as for the on-line delivery situation, except that an extra parameter is included: RDM_FILENAME; the value of which is the referenced data files full filename including the directory path on the RDM.

The file pointed to by the Class R LVO has the same format as that defined in Section 7.6. That is the same format for telemetry and auxiliary data is used for on-line delivery and off-line delivery.

Parameter	Possible values
SPACECRAFT_NAME	MEX
DATA_SOURCE	See Appendix A
DATA_TYPE	See Appendix A
ADID	Eight ASCII characters, e.g, EROST334
EARLIEST_PACKET	CCSDS format time (YYYY-MM-DDThh:mm:ssZ) Set to the string "not applicable" if the data file is empty for that day.
LATEST_PACKET	CCSDS format time (YYYY-MM-DDThh:mm:ssZ) Set to the string "not applicable" if the data file is empty for that day. Set to the same value as EARLIEST_PACKET if there is only one packet in the file on that day.
NUMBER_OF_PACKETS	ASCII encoded decimal number, no leading zeros
RDM_FILENAME	The full RDM filename, including directory name

As can be seen, in this way all the data files and data descriptions on the RDM are logically included within the VOLDESC file, and the RDM can be seen as a single SFDU product.

7.13 RDM (File View)

7.13.1 RDM Directory Structure

The RDM shall have a conventional hierarchical directory structure that divides the data into separate directories for each data type, the structure can be represented as shown below.

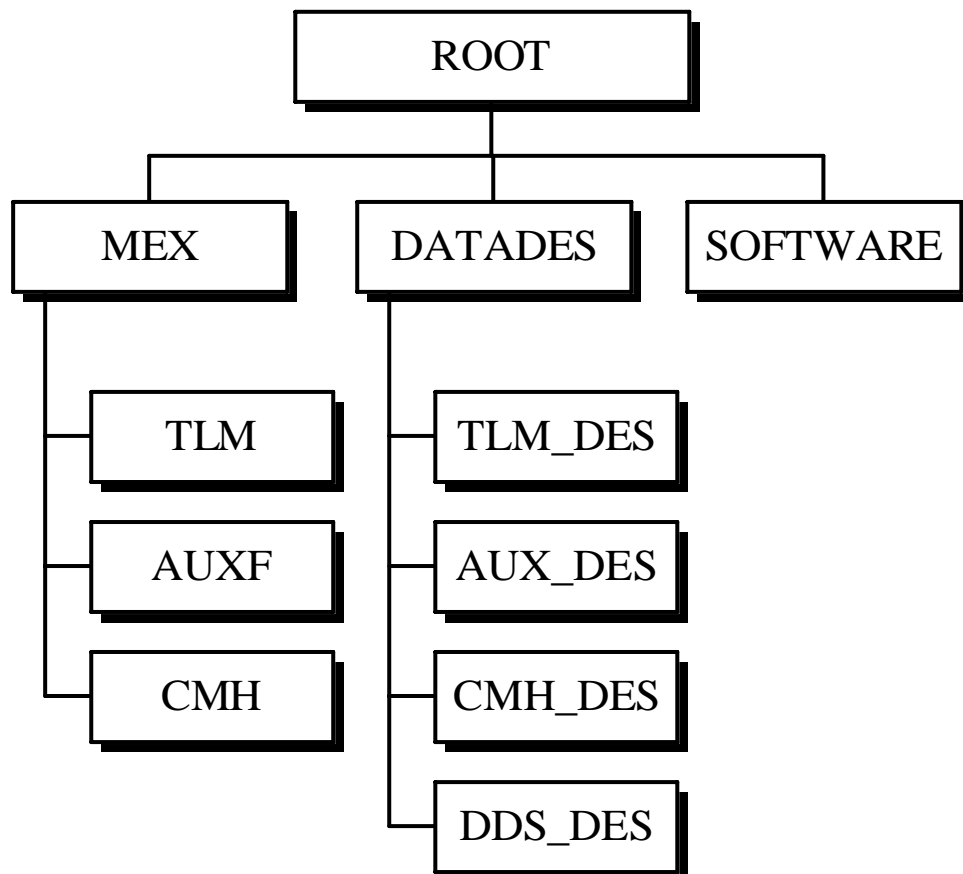

- The directory structure is self-describing. The data generated by the spacecraft and ESOC is stored in the MEX (resp. VEX) directory. This is split into three sub-directories for:
 - TLM for Telemetry data
 - CMH for Command History Data ^{037 087}
 - AUXF^{DCR284} for Auxiliary data

Note: sub-directories are created for each APID under the TLM directory ⁰⁸⁷. The format used is:

- EMEXT<hex_apid> (e.g. EMEXT334 for APID 820 [51,4])^{DCR304}

The files containing the data descriptions are stored in the DATADES directory. This is split into four sub-directories for the data types:

- TLM_DES for Telemetry description files
- AUX_DES for Auxiliary Data description files

- CMH_DES for Command History ^{087 037} description files
- DDS_DES directory that contains descriptions of the files that are specific to the DDS system and the RDM, such as the directory listing file and the cumulative index files

The SOFTWARE sub-directory contains software routines delivered by ESOC to assist in processing orbit data. These are listed in appendix H of this document.

Note that each RDM shall contain all files even if the files have zero size. This may occur when there is no data for a particular date for a data source. Zero size files are included, as this makes clear that there was no data for the data source in the time range. If a file is completely missing then it immediately indicates a manufacturing error.

7.13.2 RDM File Naming Conventions

All the files on the RDM follow a particular file naming convention, this is so that if a file should be copied from the RDM to another media with no knowledge of which directory it came from, then the filename alone is enough to unambiguously identify the file.

The convention also allows for reconstitution of files that are split over multiple media.

The CR-ROM section will be updated to make this clear.

The filenames have the following convention: ^{DCR 041, 042}

yyyymmdd-xxxxDDID-nn-i.ccc

yyyy	Year of the date of generation of the RDM (e.g. 2003).
mm	Month of the date of generation of the RDM (range 0– -12).
dd	Day of the date of generation of RDM (range 01-28, 29, 30 or 31 depending upon the month).
xxxx	File number on RDM, used to uniquely identify each file.
DDID	DDID part of the corresponding ADID (range 4 characters). In the case of description files the corresponding data stream DDID is used.
nn	The number (in hex) of the RDM set within the particular day (range 01-FF, first RDM set= 1). This field will be the same for every file on any single RDM. A set of RDMs is generated for each RDM generation request.
i	The index number for the RDM in the set
ccc	Indicating catalogue or data file <ul style="list-style-type: none"> • .cat for catalogues • .dat for data

The table below gives a list of possible values for the 'DDID' filename segment: ^{059 087}

'DDID' Value	Meaning
-------------------------	----------------

Txxx	Telemetry Packets
C001	Telecommand Packets
ORHA	Heliocentric S/C cruise orbit Auxiliary File
ORMR	Mars centric Mars swingby S/C orbit Auxiliary File
ORER	Earth centric first Earth swingby S/C orbit Auxiliary File
OROR	Lutetia ^{DCR307} centric Lutetia ^{DCR307} flyby S/C orbit Auxiliary File
ORFR	Earth centric second Earth swingby S/C orbit Auxiliary File
ORSR	Steins ^{DCR307} centric Steins ^{DCR307} flyby S/C orbit Auxiliary File
ORPR	Medium term planning comet centric S/C orbit Auxiliary File
ORWR	S/C comet centric orbit Auxiliary File
ORHW	Comet Orbit, heliocentric Auxiliary File
ORHO	Heliocentric Lutetia ^{DCR307} orbit Auxiliary File
ORHS	Heliocentric Steins ^{DCR307} orbit Auxiliary File
ATPR	S/C attitude, medium term planning Auxiliary File
ATNR	S/C attitude Auxiliary File
EVTR	Event File Auxiliary File
OASW	Orbit and attitude file access software ⁰⁴²

For example, telemetry from the MEX (resp. VEX) spacecraft, from the APID 820 instrument with the first packet from 27th April 2004, would reside in the directory:

/MEX/TLM/A5104/ (resp. /VEX/TLM/A5104/)

relative to the root directory, and would have the filename:

20040427-0001T334-01-1.dat^{DCR156}

assuming that the file resided on the first RDM produced for that day, and was the original RDM, i.e. not a reissue.

Similarly, the data description file for this data shall reside in the directory:

/DATADES/TLM_DES/A5104/

relative to the root directory, and would have the filename:

20040427-0001T334-01-1.cat^{DCR156}

There are a small number of files whose names do not follow the convention defined above, these are:

yymmddnv.LST	RDM directory listing
yymmddnv.LSC	RDM directory listing of files changed since last issue of this RDM (empty for first issue)
yymmddnv.IDX	Cumulative index file for RDM version control (see next section)
yymmddnv.LDD	Data description file for RDM directory listings
yymmddnv.IDD	Data description file for cumulative index file
yymmddnv.CDD	Data description file for the catalogue LVO (Class K LVO) in the

	VOLDESC file
yymmddnv.VDD	Data description file for the volume production information LVO (Class V LVO) in the VOLDESC file
VOLDESC.SFD	Root SFDU file

As the CD-ROM is used a capacity of approximately 650-MB is possible. Under the current baseline for data production, up to about 1000 MB of data per day will be generated. If the data produced in one day can fit in a single RDM, then this should hold one whole days worth of data, starting at the first packet received after or including 00:00:00.00 (midnight) and finishing with the last packet received before 00:00:00.00 (exclusive) of the next day. If due to the data reception profile over a single orbit, more than 600 Mbytes of data is received within a single calendar day, then a first RDM for that day will be filled until the 600 Mbytes limit is reached, and a second RDM continued from that point onwards.

Product files are written, one by one, to an RDM until it is full. To fill an RDM, GDDS may **split** the last file place the remainder on the next RDM. The split can take place at an arbitrary place in the file (such as the middle of a record). A split file must therefore be fully reconstituted before it can be used.^{DCR 043}

With regard to the handling of "splitting" data across several CDs for a day: Appendix E also describes the difference between "span valid" auxiliary files⁰⁸⁷ where a packet's data is applicable from the time of that packet up to the time of the next packet in the file, and "point valid" auxiliary files⁰³⁷ where a packet's data is applicable only at the packet time.

See Appendix D for a full list of all files that shall be delivered on each RDM and their position in the directory structure.

7.13.3 Version Control

Due to the fact that raw unprocessed data is being delivered, it is not possible to have a new version of such data, but what must be considered is the possibility of a fault in the manufacture of the RDM, an incorrect selection of files being placed on the RDM or a new release of auxiliary files due to an error in the RMCS/MEMCS. Therefore the system has been designed to handle new versions of files in the extraordinary situation that it may arise.

The present baseline for the system is that it shall generate 1 RDM per day. Another consideration is the possibility that more than 1 RDM per day may be necessary, for example in the situation that a significantly larger than expected volume of data is generated for a particular day, or a whole RDM has to be reissued due a manufacturer error.

In the root directory of each RDM there will be an index file. This file will list the full collection of RDMs since launch. Because several RDS may be produced in a single day or a single RDS may span several days, the time-span of the data shall be listed along with each RDM title in the index file. Additionally, an issue indicator for each RDM shall show where older RDM have been re-issued. This index file shall be cumulative, i.e. it contains a record of all issued RDMs up until the present date.

Furthermore, so that each RDM is self identifying (should for example the RDM be separated from its case), the cumulative index file on each RDM shall have a unique filename that identifies the date of the data on the RDM and the number of the RDM within that day. The filename shall be of the format:

yymmddnv.IDX

yy	last 2 digits of the year of the date of the data on the RDM (00-99)
----	--

mm	month of the date of the data on the RDM (01-12)
dd	day of the date of the data on the RDM (01-28, 29, 30 or 31 depending upon the month)
n	the RDM number within the particular day (1-9, first CD- ROM=1)
v	the version indicator of the RDM in the case of reissue (A-Z, initial version=A)
IDX	fixed 3 character string, indicating that this is the RDM identifier filename and index file

For example a cumulative index file named 0508122A.IDX, would indicate that the RDM contained data from the 12th August 2005, and that this was the first issue of the second RDM produced for that day.

Each entry in the cumulative index file contains: the disk identifier (i.e. cumulative index filename), start and end date/time of the telemetry data, the number of the disk within the day, the total number of disks for the day, the version number and an indication of whether the disk has been deleted (i.e. replaced by a newer issue). The fields and their character positions within the each single line entry are defined in below.

Field	Bytes	Description
RDM ID	0-7	The identifier of this RDM (the cumulative index filename minus the extension, e.g. 0512051A).
	8	Space character (ASCII 20h)
START TIME	9-28	The inclusive start time of the RDM in CCSDS format (YYYY-MM-DDThh:mm:ssZ). For the first CD in the day the hh:mm:ss component will always be 00:00:00. For subsequent CDs within the day, start time will be the (inclusive) time of the split between the previous CD and this one.
	29	Space character (ASCII 20h)
END TIME	30-49	The exclusive end time of the RDM in CCSDS format (YYYY-MM-DDThh:mm:ssZ). For the last CD in the day the hh:mm:ss component will always be 00:00:00 and the YYYY-MM-DD component will be the date of the day following the start time (since end time is exclusive). For previous CDs within the day, end time will be the (exclusive) time of the split between this CD and the next one.
	50	Space character (ASCII 20h)
RDM NUMBER	51	The number of the RDM within a single day.
	52	Space character (ASCII 20h)
TOTAL RDMS	53	The total number of RDMS in the single day.
	54	Space character (ASCII 20h)
VERSION	55	The version indicator for the RDM, A being the initial version.
	56	Space character (ASCII 20h)

Field	Bytes	Description
STATUS	57-66	A field used to indicate the status of the particular RDM. This field is blank under normal circumstances or the string DELETED (right padded with three space character- - ASCII 20h) may be present if the RDM has been replaced by a newer version.
	67	Linefeed character (ASCII 0Ah)

Note that the data fields within the record are separated by space characters (ASCII 20h). The last byte in each entry contains a linefeed character (ASCII 0Ah). Each field value is left aligned within the field and padded on the right with spaces. The Cumulative Index File itself starts with a two-line header (each line being terminated by a linefeed character- - ASCII 0Ah).

The cumulative index file is sorted in reverse chronological order, that is the newest RDM is listed at the start of the file. Any RDM reissues are inserted in the list in the correct date order, just prior to the disk that they are replacing. The index file is maintained until the end of the mission.

There will be a fixed 2 line header to the file, naming the columns of information as shown in the example file in the example below.

ID	Start	End	n	T	V	Status
=====						
0512091A	2005-12-09T 00: 00:00Z	2005-12-10T 00: 00:00Z	1	1	A	
0512081A	2005-12-08T 00: 00:00Z	2005-12-09T 00: 00:00Z	1	1	A	
0512072A	2005-12-07T 13: 14:15Z	2005-12-08T 00: 00:00Z	2	2	A	
0512071A	2005-12-07T 00: 00:00Z	2005-12-07T 13: 14:15Z	1	2	A	
0512061A	2005-12-06T 00: 00:00Z	2005-12-07T 00: 00:00Z	1	1	A	
0512051B	2005-12-05T00:00:00Z	2005-12-06T00:00:00Z	1	1	B	
0512051A	2005-12-05T 00: 00:00Z	2005-12-06T 00: 00:00Z	1	1	A	DELETED
0512041A	2005-12-04T 00: 00:00Z	2005-12-05T 00: 00:00Z	1	1	A	
0512033A	2005-12-03T 20: 10:05Z	2005-12-04T 00: 00:00Z	3	3	A	
0512032A	2005-12-03T 09: 56:40Z	2005-12-03T 20: 10:05Z	2	3	A	
0512031A	2005-12-03T 00: 00:00Z	2005-12-03T 09: 56:40Z	1	3	A	
0512021B	2005-12-02T00:00:00Z	2005-12-03T00:00:00Z	1	1	B	
0512021A	2005-12-02T 00: 00:00Z	2005-12-03T 00: 00:00Z	1	1	A	DELETED
0512011A	2005-12-01T 00: 00:00Z	2005-12-02T 00: 00:00Z	1	1	A	
0511311A	2005-11-31T 00: 00:00Z	2005-12-01T 00: 00:00Z	1	1	A	

Whenever a science community member wishes to access data from his collection of RDMS, they must first consult the cumulative index on the most recent RDM that they possess. They must then search for the particular date and time that he is interested in and then from that entry he will see the relevant RDM identifier and whether it has been replaced by a newer issue.^{DCR206} The science community members must always use the cumulative index from the most recent RDM. Reissued RDMS will have a cumulative index file containing entries for all the RDMS up to the date that the reissued RDM was produced.

As already mentioned, the root directory will also contain a file showing a directory listing of the files that have been corrected for this issue of the RDM. Science community members can consult this list of changed files to see if any of their data was affected by whatever problem caused the RDM to be reissued.

The contents of this file will be similar to the directory structure show in Appendix D apart from the fact that only files corrected for this issue (and the directories containing them) will be listed. For the first issue of any RDM, this file will be empty.

Note that when a multiple CD volume set is corrected, the times where the data is "split" across CDs may be different from the original volume set. The changed files list on each CD will contain only the corrected files for that CD, not files which have only changed due to their split time being different.

The data description of this changed listing file will be the same as that for the full RDM directory listing file.

7.13.4 Physical RDM Identification

Each RDM shall have a printed label in the top surface of the RDM. This label shall identify the physical RDM for handling purposes. The format of the label shall be ^{DCR285}:

Mars Express (resp. Venus Express)
Daily Backup for yyyy-mm-dd_n_N A
ESOC
Robert-Bosch-Str., 5
D-64293 Darmstadt

yyyy-mm-dd	is the date of the data on the RDM
n	is the number of the RDM within the particular day
N	is the total number of RDMs within the particular day
A	is the version number of the RDM, (range A-Z, where A is the initial release)

The volume label of the RDM will also use this format. For example, a RDM from 12th December 2004 which is the second of three RDMs, and is the initial issue, would have the following printed label and volume label:

20041212_2_3A

7.13.5 Data Description Information

Following the CCSDS SFDU standard, each file of data delivered is tagged (either physically or via a pointer) with a label that includes an indicator of the data description information that clearly defines the format of the data. This indicator is called the Authority and Description Identifier or ADID. It indicates not only the particular description that applies to the attached data, but also the space agency that archives and maintains the description. For Rosetta, Mars Express, and Venus Express missions, all the raw data descriptions are stored at ESOC, therefore of the 8 characters allocated to the ADID, the first 4 (the Control Authority Identifier) are always "EROS", "EMEX" ^{DCR151}, or "EVEX". The remaining 4 characters are assigned by the mission as defined in Appendix A.

So that the data on the RDMs is understandable without other external data sources or repeated access back to ESOC for the registered descriptions, each RDM shall contain a

full copy of the data description information that is available, for all the data delivered on that RDM. This includes all telemetry data, telemetry parameter definition data and auxiliary data. For each of these sources of data the description data provided is of varying degrees of detail, depending upon what is available to ESOC.

For the science telemetry, the description provided is at a relatively high level, with no byte or bit level information. This is due to the fact that the inner details of the experiment packets lie in the domain of the PIs and not with ESOC. Therefore the data description shall simply state the following:

- Which experiment and spacecraft the data originates from;
- The institute and contact point that is responsible for the experiment and therefore the point of contact to get further details of the experiment data format.
- Any other more detailed information that can be provided by the PIs to explain the data format.

For the auxiliary data, i.e. that data which is provided directly by ESOC, such as orbit and attitude data, time calibration data etc. the full description of the data will be provided as an ASCII English text document. Essentially each auxiliary data file is described in Appendix E, these descriptions will be registered at ESOC as Rosetta / MEX / VEX ADIDs, and then copied onto each RDM. No further information will be required to fully interpret this data.⁰⁸⁷

8. Appendix A: Data Streams Available and ADIDs

This appendix lists all the data streams that are available from the DDS on-line and also delivered on RDM. When a PI requests a data stream on-line he specifies the data source and data type. The data source and data-type are listed in the first 2 columns of the table starting at the bottom of this page. The data type, which indicates a general categorisation of the data content, must be one of the following:

MNEMONIC	Data Type
CAT	Catalogue data
AUX	Auxiliary data
TLM	Telemetry data ⁰⁸⁷
CMH	Command History Data

As has already been stated, each packet of data delivered has a DDS packet header attached to it. ^{DCR206}

All data delivered has a corresponding data description registered at ESOC, and delivered on each RDM. The identifier of these data descriptions (called the ADID) is shown in the fourth column for each of the available data streams. ^{037, 041 059, DCR048}

Data Source	Data Type	Data Description Title	ADID
Common ROSETTA, MARS EXPRESS, and VENUS EXPRESS ^{DCR252} non-Auxiliary Data			
-	-	Rosetta / MEX / VEX RDM directory tree listing format	EROSD001 or ^{DCR151} EMEXD001 or ^{DCR252} EVEXD001
-	-	Rosetta / MEX / VEX RDM cumulative index file format	EROSD002 or ^{DCR151} EMEXD002 or ^{DCR252} EVEXD002
-	-	Catalogue format for Rosetta / MEX / VEX off-line delivery	EROSD003 or ^{DCR151} EMEXD003 or ^{DCR252} EVEXD003
-	-	Catalogue format for Rosetta / MEX / VEX on-line delivery	EROSD004 or ^{DCR151} EMEXD004 or ^{DCR252} EVEXD004
-	-	Acknowledgement format for Rosetta / MEX / VEX on-line delivery	EROSD005 or ^{DCR151} EMEXD005 or ^{DCR252} EVEXD005
-	-	Volume production information format for Rosetta / MEX / VEX off-line delivery	EROSD006 or ^{DCR151} EMEXD006 or ^{DCR252} EVEXD006
-	-	Master catalogue of all Rosetta / MEX / VEX data available	EROSD007 or ^{DCR151} EMEXD007 or ^{DCR252} EVEXD007
-	-	Catalogue of part of the Rosetta / MEX / VEX data available	EROSD008 or ^{DCR151} EMEXD008 or ^{DCR252} EVEXD008

Data Source	Data Type	Data Description Title	ADID
<APID>	TLM	Telemetry data for a specific APID	EROSTxxx or EMEXTxxx ^{DCR151} or EVEXTxxx ^{DCR252}
<SuperAPID>	TLM	Telemetry data for a specific instrument (see below) DCR195	EROSTxxx or EMEXTxxx ^{DCR151} or EVEXTxxx ^{DCR252}
CMDH	CMH	Telecommand History Packets	EROSC001 or EMEXC001 ^{DCR151} or EVEXC001 ^{DCR252}
CMDPF	CMH	Telecommand History Printout (full mode) ^{DCR152}	EROSC002 or EMEXC002 ^{DCR151} or EVEXC002 ^{DCR252}
CMDPB	CMH	Telecommand History Printout (brief mode) ^{DCR152}	EROSC003 or EMEXC003 ^{DCR151} or EVEXC003 ^{DCR252}
ROSETTA			
-1	TLM	Telemetry data for LCC ^{DCR195}	ESOSTLCC
-2	TLM	Telemetry data for RPC ^{DCR195}	ESOSTRPC
-3	TLM	Telemetry data for OSIRIS ^{DCR195}	ESOSTOSI
-4	TLM	Telemetry data for ALICE ^{DCR195}	ESOSTALI
-5	TLM	Telemetry data for MIRO ^{DCR195}	ESOSTMIR
-6	TLM	Telemetry data for ROSINA ^{DCR195}	ESOSTROS
-7	TLM	Telemetry data for COSIMA ^{DCR195}	ESOSTCOS
-8	TLM	Telemetry data for CONSERT ^{DCR195}	ESOSTCON
-9	TLM	Telemetry data for VIRTIS ^{DCR195}	ESOSTVIR
-10	TLM	Telemetry data for GIADA ^{DCR316}	EROSTGIA
-11	TLM	RSOC (Ack Service 1) ^{DCR316}	EROSTRS1
-12	TLM	RSOC (HK Service 3) ^{DCR316}	EROSTRS2
-13	TLM	RSOC (EV Service 5) ^{DCR316}	EROSTRS3
-14	TLM	RSOC (Dumps Service 6) ^{DCR316}	EROSTRS4
-15	TLM	RSOC (Sci Service 12) ^{DCR316}	EROSTRS5
-16	TLM	RPC (Ack Service 1) ^{DCR367}	ESOSTRP1
-17	TLM	RPC (HK Service 3) ^{DCR367}	ESOSTRP2
-18	TLM	RPC (EV Service 5) ^{DCR367}	ESOSTRP3
-19	TLM	RPC (Dumps Service 6) ^{DCR367}	ESOSTRP4
-20	TLM	RPC (Sci Service 12) ^{DCR367}	ESOSTRP5
AGC1	AUX	RSI Automatic Gain Control data1 from IFMS ^{DCR 248}	EROSAGC1
AGC2	AUX	RSI Automatic Gain Control data2 from IFMS ^{DCR 248}	EROSAGC2
ATNR	AUX	S/C attitude	EROSATNR
ATPR	AUX	S/C attitude, medium term planning	EROSATPR
CCHA	AUX	Comet Characteristics	EROSCCHA

Data Source	Data Type	Data Description Title	ADID
CENV	AUX	Cometary Environment	EROSCENV
CKIN	AUX	Comet Kinematics	EROSCKIN
CONF	AUX	Conflict File	EROSCONF
D1FD	AUX	Doppler 1 Data File (for Flight Dynamics) ^{DCR141}	EROSD1FD
D2FD	AUX	Doppler 2 Data File (for Flight Dynamics) ^{DCR141}	EROSD2FD
DOP1	AUX	Doppler 1 Data File (for RSI) ^{DCR122, DCR141}	EROSDOP1
DOP2	AUX	Doppler 2 Data File (for RSI) ^{DCR122, DCR141}	EROSDOP2
DOR_	AUX	Direct Operation Request	EROSDOR_
ECF_	AUX	Expedite Command File Operational	EROSECF_
EVTR	AUX	Event File	EROSEVTR
FDR_	AUX	Flight Dynamics Request	EROSFDR_
G1FD	AUX	Flight Dynamics Automatic Gain Control data1 from IFMS ^{DCR248}	EROSG1FD
G2FD	AUX	Flight Dynamics Automatic Gain Control data2 from IFMS ^{DCR248}	EROSG2FD
LTVF	AUX	Lander TC Verification File	EROSLTVF
MCR_	AUX	Memory Checksum Request - Operational	EROSMCR_
MDAF	AUX	MTL-DAF (See Note 5) ^{DCR135}	EROSMDAF
MDR_	AUX	Memory Dump Request - Operational	EROSMDR_
MET_	AUX	Meteo[rological] Data File (for RSI) ^{DCR122, DCR141}	EROSMET_
MPR_	AUX	Memory Patch Request - Operational	EROSMPR_
MSP_	AUX	Master Science Plan	EROSMSP_
MTFD	AUX	Meteo[rological] Data File (for Flight Dynamics) ^{DCR141}	EROSMTFD
OASW	AUX	Orbit and attitude file access software	EROSOASW
ORER	AUX	Earth centric first Earth swingby S/C orbit	EROSORER
ORFR	AUX	Earth centric second Earth swingby S/C orbit	EROSORFR
ORGR	AUX	Earth centric third Earth swingby S/C orbit ^{DCR268}	EROSORGR
ORHO	AUX	Heliocentric Lutetia ^{DCR307} orbit	EROSORHO
ORHR	AUX	Heliocentric S/C cruise orbit	EROSORHR
ORHS	AUX	Heliocentric Steins ^{DCR307} orbit	EROSORHS
ORHW	AUX	Comet Orbit, heliocentric	EROSORHW
ORMR	AUX	Mars centric Mars swingby S/C orbit	EROSORMR
OROR	AUX	Lutetia ^{DCR307} centric Lutetia ^{DCR307} flyby S/C orbit	EROSOROR
ORPR	AUX	Medium term planning comet centric S/C orbit	EROSORPR
ORSR	AUX	Steins ^{DCR307} centric Steins ^{DCR307} flyby S/C orbit	EROSORSR
ORWR	AUX	S/C comet centric orbit	EROSORWR
PNAV	AUX	Processed NAVCAM Images	EROSPNAV
POR_	AUX	Payload Operation Request - Operational	EROSPOR_
PORP ^{DCR 224}	AUX	Preliminary Payload Operation Request	EROSPORP
PTR_ ^{DCR224}	AUX	Pointing Timeline Request	EROSPTR_

Data Source	Data Type	Data Description Title	ADID
PTRP ^{DCR224}	AUX	Preliminary Pointing Timeline Request	EROSPTRP
RANG	AUX	Ranging Data File (for RSI) ^{DCR122, DCR141}	EROSRANG
RGFD	AUX	Ranging Data File (for Flight Dynamics) ^{DCR141}	EROSRGFD
SOR_	AUX	Spacecraft Operation Request	EROSSOR_
SPL_ ^{DCR275}	AUX	Scenario Parameter List (reference document SOIA)	EROSSPL_
MARS EXPRESS			
-1	TLM	Telemetry data for HRSC ^{DCR195}	EMEXTHRS
-2	TLM	Telemetry data for PFS ^{DCR195}	EMEXTPFS
AGC1	AUX	RSI Automatic Gain Control data1 from IFMS ^{DCR 248}	EMEXAGC1
AGC2	AUX	RSI Automatic Gain Control data2 from IFMS ^{DCR 248}	EMEXAGC2
ATNM	AUX	Predicted / reconstituted S/C attitude	EMEXATNM
D1FD	AUX	Doppler 1 Data File (for Flight Dynamics) ^{DCR141}	EMEXD1FD
D2FD	AUX	Doppler 2 Data File (for Flight Dynamics) ^{DCR141}	EMEXD2FD
DMOP	AUX	Detailed Mission Operations File	EMEXDMOP
DOP1	AUX	Doppler 1 Data File (for RSI) ^{DCR141}	EMEXDOP1
DOP2	AUX	Doppler 2 Data File (for RSI) ^{DCR141}	EMEXDOP2
DOR_	AUX	Direct Operation Request	EMEXDOR_
DSOP	AUX	Detailed Science Operations File	EMEXDSOP
ECF_	AUX	Expedite Command File	EMEXECF_
EVTF	AUX	Event File. Long Term Planning	EMEXEVTF
EVTM	AUX	Event File ^{DCR152}	EMEXEVTM
FDR_	AUX	Flight Dynamics Request	EMEXFDR_
FDSW	AUX	FORTTRAN Software Source Code Files ^{DCR152}	EMEXFDSW
FECS	AUX	Preliminary Events and Communications Skeleton	EMEXFECS
FTL_ ^{DCR330}	AUX	Flight Dynamics Timeline	EMEXFTL_ ^{DCR330}
G1FD	AUX	Flight Dynamics G1FD data from IFMS ^{DCR248}	EMEXG1FD
G2FD	AUX	Flight Dynamics G2FD data from IFMS ^{DCR248}	EMEXG2FD
MCR_	AUX	Memory Checksum Request	EMEXMCR_
MDAF	AUX	MTL-DAF (See Note 5) ^{DCR135}	EMEXMDAF
MDR_	AUX	Memory Dump Request	EMEXMDR_
MET_	AUX	Meteo[rological] Data File (for RSI) ^{DCR141}	EMEXMET_
MPR_	AUX	Memory Patch Request	EMEXMPR_
MTFD	AUX	Meteo[rological] Data File (for Flight Dynamics) ^{DCR141}	EMEXMTFD
OASW	AUX	Orbit and attitude file access software (various)	EMEXOASW
ORHM	AUX	S/C orbit, cruise, heliocentric	EMEXORHM
ORMF	AUX	S/C orbit, operational, Mars centric. (Long Term Planning (See Note 6 ^{DCR117}))	EMEXORMF

Data Source	Data Type	Data Description Title	ADID
ORMM	AUX	S/C orbit, operational, Mars centric	EMEXORMM
OWLT	AUX	One-Way Light Time File	EMEXOWLT
POR_	AUX	Payload Operation Request	EMEXPOR_
PTR_ ^{DCR330}	AUX	Pointing Timeline Request (TBD)	EMEXPTR_ ^{DCR330}
RANG	AUX	Ranging Data File (for RSI) ^{DCR141}	EMEXRANG
RGFD	AUX	Ranging Data File (for Flight Dynamics) ^{DCR141}	EMEXRGFD
RMOP	AUX	Restituted Detailed Mission Operations File	EMEXRMOP
RSOP	AUX	Restituted Detailed Science Operations File	EMEXRSOP
SECS	AUX	Updated Events and Communication Skeleton	EMEXSECS
SOR_	AUX	Spacecraft Operation Request (OPE)	EMEXSOR_
SOR_	AUX	Spacecraft Operation Request (MPS)	EMEXSOR_
STOM	AUX	Star occultations	EMEXSTOM
VILM	AUX	Lander Visibility ^{DCR152}	EMEXVILM
VENUS EXPRESS ^{DCR252 DCR325}			
-2 ^{DCR 341}	TLM	Telemetry for PFS	EVEXTPFS
-3 ^{DCR 341}	TLM	Telemetry for ASPERA	EVEXTASP
-9 ^{DCR 341}	TLM	Telemetry for VIRTIS	EVEXTVIR
AGC1	AUX	RSI Automatic Gain Control data1 from IFMS	EVEXAGC1
AGC2	AUX	RSI Automatic Gain Control data2 from IFMS	EVEXAGC2
ATNV ^{DCR343}	AUX	Predicted / reconstituted S/C attitude	EVEXATNV
ATPV ^{DCR 343}	AUX	Medium Term Attitude prediction	EVEXATPV
D1FD	AUX	Doppler 1 Data File (for Flight Dynamics)	EVEXD1FD
D2FD	AUX	Doppler 2 Data File (for Flight Dynamics)	EVEXD2FD
DMOP	AUX	Detailed Mission Operations File	EVEXDMOP
DOP1	AUX	Doppler 1 Data File (for RSI)	EVEXDOP1
DOP2	AUX	Doppler 2 Data File (for RSI)	EVEXDOP2
DOR_	AUX	Direct Operation Request	EVEXDOR_
DSOP	AUX	Detailed Science Operations File	EVEXDSOP
ECF_	AUX	Expedite Command File	EVEXECF_
EVTF	AUX	Event File. Long Term Planning	EVEXEVTF
EVTP ^{DCR 343}	AUX	Event File. Medium Term Planning	EVEXEVTP
EVTV ^{DCR343}	AUX	Event File	EVEXEVTV
FDR_	AUX	Flight Dynamics Request	EVEXFDR_
FDSW	AUX	FORTTRAN Software Source Code Files	EVEXFDSW
FECS	AUX	Preliminary Events and Communications Skeleton	EVEXFECS
FTLV ^{DCR343}	AUX	Flight Dynamics Timeline	EVEXFTLV ^{DCR343}
FSCV ^{DCR343}	AUX	Flight Dynamics SOC Constants File	EVEXFSCV
G1FD	AUX	Flight Dynamics G1FD data from IFMS	EVEXG1FD
G2FD	AUX	Flight Dynamics G2FD data from IFMS	EVEXG2FD

Data Source	Data Type	Data Description Title	ADID
MCR_	AUX	Memory Checksum Request	EVEXMCR_
MDAF	AUX	MTL-DAF (See Note 5)	EVEXMDAF
MDR_	AUX	Memory Dump Request	EVEXMDR_
MET_	AUX	Meteo[rological] Data File (for RSI)	EVEXMET_
MPR_	AUX	Memory Patch Request	EVEXMPR_
MTFD	AUX	Meteo[rological] Data File (for Flight Dynamics)	EVEXMTFD
OASW	AUX	Orbit and attitude file access software (various)	EVEXOASW
ORHV ^{DCR343}	AUX	S/C orbit, cruise, heliocentric	EVEXORHV
ORVF ^{DCR343}	AUX	S/C orbit, operational, Venus centric. Long Term Planning (See Note 6)	EVEXORVF
ORVV ^{DCR343}	AUX	S/C orbit, operational, Venus centric	EVEXORVV
OWLT	AUX	One-Way Light Time File	EVEXOWLT
POR_	AUX	Payload Operation Request	EVEXPOR_
PTRV ^{DCR343}	AUX	Pointing Timeline Request (TBD)	EVEXPTRV ^{DCR343}
RANG	AUX	Ranging Data File (for RSI)	EVEXRANG
RGFD	AUX	Ranging Data File (for Flight Dynamics)	EVEXRGFD
RMOP	AUX	Restituted Detailed Mission Operations File	EVEXRMOP
RSOP	AUX	Restituted Detailed Science Operations File	EVEXRSOP
SAAV ^{DCR 343}	AUX	Sun Aspect Angles File	EVEXSAAV
SOR_	AUX	Spacecraft Operation Request (OPE)	EVEXSOR_
SOR_	AUX	Spacecraft Operation Request (MPS)	EVEXSOR_
SPL_	AUX	Scenario Parameter List (TBD)	EVEXSPL_
STOV ^{DCR343}	AUX	Star occultations	EVEXSTOV
TMSV ^{DCR343}	AUX	Trajectory Manoeuvre Slot Schedule	EVEXTMSV
UCAV ^{DCR343}	AUX	User Custom Attitude File	EVEXUCAV

Notes:

1. The <APID> data source is the integer value of the APID. ^{DCR204}
2. For data source <APID>, the ADID is derived as follows.

The <Process ID> is converted into a 2-digit hexadecimal number. The <Packet Category> is converted into a 1-digit hexadecimal number. These are combined to give a 3-digit hexadecimal number xxx, which forms the last 3-digits of the ADID.

E.g. for Process ID 51 (=33 hex), Packet Category 4 (=4 hex) the corresponding ADID is EROST334 for data type TLM.
3. It should be noted that with the above convention, telemetry packets with the same APID but different SID will be assigned to the same ADID.
4. Appendix E lists the references that define the format of each auxiliary file. ^{038 048 059}
5. It is not possible for these files to be automatically forwarded, users must submit requests for these files. ^{DCR135}
6. Due to the expected size of this file (circa 800 Megabytes) it will not be available for on-line delivery, but will instead be delivered via FTP and ^{DCR343} on RDM. ^{DCR117 DCR206}
7. For data source <SuperAPID>, the value of *SuperAPID* is a negative integer value which corresponds to a predefined list of APIDs; when a single request is made using a super-APID, packets from all APIDs in the list are included in the response. ^{DCR195}

9. Appendix B: DDS Error handling

9.1 DDS Generated Error Messages

This appendix lists all the possible error messages, which can be returned by the "**ERROR_MESSAGE**" parameter in an acknowledgement. They are all given as an ASCII string and are of the forms:

```
ROSETTA DDS ERROR-nn: <String>    for Rosetta
MEX DDS ERROR-nn: <String>        for Mars Express
VEX DDS ERROR-nn: <String>        for Venus ExpressDCR252
```

There are two groups of error messages.

- Errors in the specification of the request
- Errors in the processing of the request

It should be noted that all errors are reported in a file (SFDU format) sent to the user's default node / location as described in section 7.9. In addition, the former group of errors are reported (as text, not in SFDU format) directly to the interactive Web user interface, if possible.

In the following lists the error number, nn, is given and the error message. The lists are preliminary and will be updated following the design and implementation of the DDS

Errors in the specification of the request^{DCR316}

```
NO ERROR
DDS ERROR-01: Unrecognised data source.
DDS ERROR-02: Unrecognised data type.
DDS ERROR-03: Illegal combination of data source/type.
DDS ERROR-04: No access rights to requested data SOURCE.TYPE.
DDS ERROR-05: Illegal target filename specified.
DDS ERROR-06: Illegal start date/time format.
DDS ERROR-07: Illegal end date/time format.
DDS ERROR-08: Start time greater than end time.
DDS ERROR-09: Illegal sample rate.
DDS ERROR-10: Illegal amount value specified.
```

Errors in the processing of the request^{DCR316}

```
NO ERROR
DDS ERROR-50: Maximum number of outstanding files exceeded.
DDS ERROR-51: No catalogue data within time requested.
DDS ERROR-52: No data packets available within time requested.
DDS ERROR-53: System timeout, try again later.
DDS ERROR-54: System unavailable, try again later.
DDS ERROR-55: System resources exceeded, try again later.
DDS ERROR-56: System error occurred, try again later.
DDS ERROR-57: Request would exceed permitted daily quota.
DDS ERROR-58: Request would exceed permitted system daily quota.
DDS ERROR-59: DDS access disabled.
```

9.2 Contact Points in Case of Problems

This appendix defines the contact points and procedure for the PIs to follow in the case of problems with the DDS. The line of reporting is shown below.

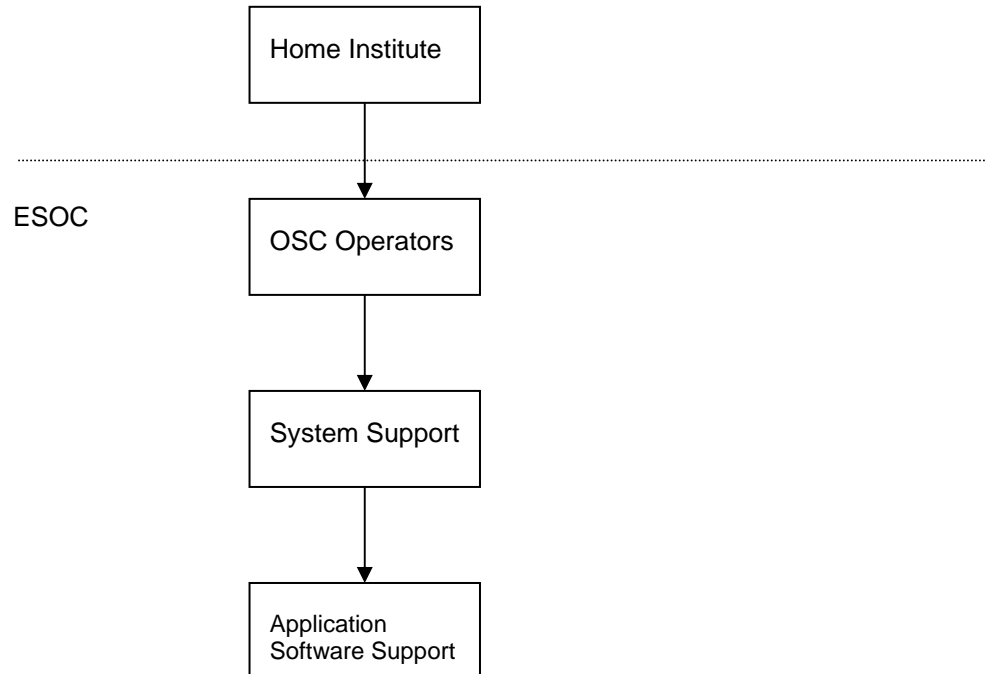

If a PI has a problem with the DDS, which requires human contact with ESOC then they should telephone the OSC (formerly called RTSS) operators. Information given to the OSC operators must include the nature of the failure, probability of location of fault, time of occurrence, priority associated to the transmission of the data, etc. The OSC operators will escalate the problem, if required, to System Support or Application Support. ESOC will endeavour to respond to the failure within 1 hour.

The contact point at ESOC is: OSC (Operations Support Centre)
Telephone extension 2249 or internationally: (+49)-6151-902249
Fax number: (+49)-6151-903061

Note: Fax may be used but it must be previously announced by a telephone call.

If a problem occurs which does not require immediate human contact with ESOC, then an e-mail should be sent to: esoc.osc@esa.int. ^{DCR163}

10. Appendix C: Accounts

This is provided as a separate document.(A-6).^{DCR147, DCR265}

11. Appendix D: Full MEX RDM Directory and File Listing

This appendix lists all files that shall be delivered on the RDM to each recipient Mars Express science community member.

DCR294

ProductADID	Description
EMEXAGC1	AGC 1 Data File (for RSI)
EMEXAGC2	AGC 2 Data File (for RSI)
EMEXATNM	Predicted / reconstituted S/C attitude
EMEXDMOP	Detailed Mission Operations File
EMEXD1FD	Doppler 1 Data File (for Flight Dynamics)
EMEXD2FD	Doppler 2 Data File (for Flight Dynamics)
EMEXDOP1	Doppler 1 Data File (for RSI)
EMEXDOP2	Doppler 2 Data File (for RSI)
EMEXDOR_	Direct Operation Request
EMEXDSOP	Detailed Science Operations File
EMEXECF_	Expedite Command File
EMEXEVTF	Event File. Long Term Planning
EMEXEVTM	Event File.
EMEXFDR_	Flight Dynamics Request
EMEXFDSW	FORTRAN Software Source Code Files
EMEXFECS	Preliminary Events and Communications Skeleton
EMEXFTL_	Flight Dynamics Timeline
EMEXG1FD	AGC 1 Data File (for Flight Dynamics)
EMEXG2FD	AGC 2 Data File (for Flight Dynamics)
EMEXMCR_	Memory Checksum Request
EMEXMDAF	MTL-DAF
EMEXMDR_	Memory Dump Request
EMEXMET_	Meteorological Data File (for RSI)
EMEXMPR_	Memory Patch Request
EMEXMTFD	Meteorological Data File (for Flight Dynamics)
EMEXOASW	Orbit and attitude file access software (various)
EMEXORHM	S/C orbit, cruise, heliocentric
EMEXORMF	S/C orbit, operational, Mars centric. Long term planning
EMEXORMM	S/C orbit, operational, Mars centric
EMEXOWLT	One-Way Light Time File
EMEXPOR_	Payload Operation Request
EMEXPTR_	Pointing Timeline Request (TBD)
EMEXRANG	Ranging Data File (for RSI)
EMEXRGFD	Ranging Data File (for Flight Dynamics)
EMEXRMOP	Restituted Detailed Mission Operations File
EMEXRSOP	Restituted Detailed Science Operations File
EMEXSECS	Updated Events and Communication Skeleton
EMEXSOR_	Spacecraft Operation Request (OPE)
EMEXSPL_	Scenario Parameter List (TBD)
EMEXSTOM	Star occultations
EMEXVILM	Lander Visibility
EMEXC001	TC binary packet data
EMEXC002	TC full mode ASCII data
EMEXC003	TC brief mode ASCII data
EMEXT000	TM from APID 0 (TIME TIME)
EMEXT011	TM from APID 17 (DMS ACKNOWLEDGE)

ProductADID	Description
EMEXT013	TM from APID 19 (DMS TABLE)
EMEXT014	TM from APID 20 (DMS HK)
EMEXT017	TM from APID 23 (DMS EVENT)
EMEXT019	TM from APID 25 (DMS DUMP)
EMEXT01A	TM from APID 26 (DMS FILE TRANSFER)
EMEXT024	TM from APID 36 (Spare for Avionics HK)
EMEXT044	TM from APID 68 (Spare for Avionics HK)
EMEXT074	TM from APID 116 (Spare for Avionics HK)
EMEXT0B1	TM from APID 177 (AOCMS ACKNOWLEDGE)
EMEXT0B4	TM from APID 180 (AOCMS HK)
EMEXT0B7	TM from APID 183 (AOCMS EVENT)
EMEXT0B9	TM from APID 185 (AOCMS DUMP)
EMEXT0C4	TM from APID 196 (Spare for Avionics HK)
EMEXT0D4	TM from APID 212 (Spare for Avionics HK)
EMEXT0E4	TM from APID 228 (Spare for Avionics HK)
EMEXT0F4	TM from APID 244 (Spare for Avionics HK)
EMEXT124	TM from APID 292 (Spare for Avionics HK)
EMEXT134	TM from APID 308 (Spare for Avionics HK)
EMEXT144	TM from APID 324 (Spare for Avionics HK)
EMEXT151	TM from APID 337 (FIRMWARE in SM of PM1 ACKNOWLEDGE)
EMEXT156	TM from APID 342 (FIRMWARE in SM of PM1 FUNCTIONAL NON CYCLIC (ad-hoc measurement))
EMEXT157	TM from APID 343 (FIRMWARE in SM of PM1 EVENT)
EMEXT159	TM from APID 345 (FIRMWARE in SM of PM1 DUMP)
EMEXT161	TM from APID 353 (FIRMWARE in SM of PM2 ACKNOWLEDGE)
EMEXT166	TM from APID 358 (FIRMWARE in SM of PM2 FUNCTIONAL NON CYCLIC (ad-hoc measurement))
EMEXT167	TM from APID 359 (FIRMWARE in SM of PM2 EVENT)
EMEXT169	TM from APID 361 (FIRMWARE in SM of PM2 DUMP)
EMEXT171	TM from APID 369 (FIRMWARE in SM of PM3 ACKNOWLEDGE)
EMEXT176	TM from APID 374 (FIRMWARE in SM of PM3 FUNCTIONAL NON CYCLIC (ad-hoc measurement))
EMEXT177	TM from APID 375 (FIRMWARE in SM of PM3 EVENT)
EMEXT179	TM from APID 377 (FIRMWARE in SM of PM3 DUMP)
EMEXT181	TM from APID 385 (FIRMWARE in SM of PM4 ACKNOWLEDGE)
EMEXT186	TM from APID 390 (FIRMWARE in SM of PM4 FUNCTIONAL NON CYCLIC (ad-hoc measurement))
EMEXT187	TM from APID 391 (FIRMWARE in SM of PM4 EVENT)
EMEXT189	TM from APID 393 (FIRMWARE in SM of PM4 DUMP)
EMEXT191	TM from APID 401 (SSMM ACKNOWLEDGE)
EMEXT193	TM from APID 403 (SSMM TABLE)
EMEXT194	TM from APID 404 (SSMM HK)
EMEXT197	TM from APID 407 (SSMM EVENT)
EMEXT199	TM from APID 409 (SSMM DUMP)
EMEXT19A	TM from APID 410 (SSMM FILE TRANSFER)
EMEXT19D	TM from APID 413 (SSMM Rice Transport Packet)
EMEXT1A1	TM from APID 417 (STR1 ACKNOWLEDGE)
EMEXT1A4	TM from APID 420 (STR1 HK)
EMEXT1A5	TM from APID 421 (STR1 FUNCTIONAL CYCLIC (high frequency measurement))
EMEXT1A6	TM from APID 422 (STR1 FUNCTIONAL NON CYCLIC (ad-hoc measurement))
EMEXT1A7	TM from APID 423 (STR1 EVENT)
EMEXT1A9	TM from APID 425 (STR1 DUMP)
EMEXT1B1	TM from APID 433 (STR2 ACKNOWLEDGE)

ProductADID	Description
EMEXT1B4	TM from APID 436 (STR2 HK)
EMEXT1B5	TM from APID 437 (STR2 FUNCTIONAL CYCLIC (high frequency measurement))
EMEXT1B6	TM from APID 438 (STR2 FUNCTIONAL NON CYCLIC (ad-hoc measurement))
EMEXT1B7	TM from APID 439 (STR2 EVENT)
EMEXT1B9	TM from APID 441 (STR2 DUMP)
EMEXT3D1	TM from APID 977 (ASPERA ACKNOWLEDGE)
EMEXT3D4	TM from APID 980 (ASPERA HK)
EMEXT3D7	TM from APID 983 (ASPERA EVENT)
EMEXT3D9	TM from APID 985 (ASPERA DUMP)
EMEXT3DC	TM from APID 988 (ASPERA PRIVATE-SCIENCE or TELECOMMAND)
EMEXT3E1	TM from APID 993 (ASPERA ACKNOWLEDGE)
EMEXT3E4	TM from APID 996 (ASPERA HK)
EMEXT3E7	TM from APID 999 (ASPERA EVENT)
EMEXT3EC	TM from APID 1004 (ASPERA PRIVATE-SCIENCE or TELECOMMAND)
EMEXT421	TM from APID 1057 (HRSC ACKNOWLEDGE)
EMEXT424	TM from APID 1060 (HRSC HK)
EMEXT427	TM from APID 1063 (HRSC EVENT)
EMEXT429	TM from APID 1065 (HRSC DUMP)
EMEXT43C	TM from APID 1084 (HRSC PRIVATE-SCIENCE or TELECOMMAND)
EMEXT471	TM from APID 1137 (MELACOM ACKNOWLEDGE)
EMEXT474	TM from APID 1140 (MELACOM HK)
EMEXT477	TM from APID 1143 (MELACOM EVENT)
EMEXT48C	TM from APID 1164 (MELACOM PRIVATE-SCIENCE or TELECOMMAND)
EMEXT4C1	TM from APID 1217 (MARSIS ACKNOWLEDGE)
EMEXT4C4	TM from APID 1220 (MARSIS HK)
EMEXT4C7	TM from APID 1223 (MARSIS EVENT)
EMEXT4C9	TM from APID 1225 (MARSIS DUMP)
EMEXT4D9	TM from APID 1241 (MARSIS DUMP)
EMEXT4DC	TM from APID 1244 (MARSIS PRIVATE-SCIENCE or TELECOMMAND)
EMEXT4E9	TM from APID 1257 (MARSIS DUMP)
EMEXT4EC	TM from APID 1260 (MARSIS PRIVATE-SCIENCE or TELECOMMAND)
EMEXT4F9	TM from APID 1273 (MARSIS DUMP)
EMEXT4FC	TM from APID 1276 (MARSIS PRIVATE-SCIENCE or TELECOMMAND)
EMEXT50C	TM from APID 1292 (MARSIS PRIVATE-SCIENCE or TELECOMMAND)
EMEXT511	TM from APID 1297 (OMEGA ACKNOWLEDGE)
EMEXT514	TM from APID 1300 (OMEGA HK)
EMEXT517	TM from APID 1303 (OMEGA EVENT)
EMEXT519	TM from APID 1305 (OMEGA DUMP)
EMEXT51C	TM from APID 1308 (OMEGA PRIVATE-SCIENCE or TELECOMMAND)
EMEXT561	TM from APID 1377 (PFS ACKNOWLEDGE)
EMEXT564	TM from APID 1380 (PFS HK)
EMEXT567	TM from APID 1383 (PFS EVENT)
EMEXT569	TM from APID 1385 (PFS DUMP)
EMEXT57C	TM from APID 1404 (PFS PRIVATE-SCIENCE or TELECOMMAND)
EMEXT584	TM from APID 1412 (PFS HK)
EMEXT604	TM from APID 1540 (SPICAM HK)

ProductADID	Description
EMEXT60C	TM from APID 1548 (SPICAM PRIVATE-SCIENCE or TELECOMMAND)
EMEXT657	TM from APID 1623 (Beagle-2 EVENT)
EMEXT65C	TM from APID 1628 (Beagle-2 PRIVATE-SCIENCE or TELECOMMAND)
EMEXT66C	TM from APID 1644 (MERA PRIVATE-SCIENCE or TELECOMMAND)
EMEXT67C	TM from APID 1660 (MERB PRIVATE-SCIENCE or TELECOMMAND)
EMEXT6AC	TM from APID 1708 (VMC PRIVATE-SCIENCE or TELECOMMAND)
EMEXT791	TM from APID 1937 (ESOC PSS ACKNOWLEDGE)
EMEXT794	TM from APID 1940 (ESOC PSS HK)
EMEXT7AE	TM from APID 1966 (MCS Reserved OCC/EGSE)
EMEXT7FF	TM from APID 2047 (Idle TM packet IDLE)
EMEXTHRS	Super APID for HRSC
EMEXTPFS	Super APID for PFS
EMEXTASP	Super APID for ASPERA-3

12. Appendix E: List of DDS Auxiliary Data

This appendix lists the Rosetta / MEX / VEX auxiliary data provided by ESOC. The table below provides the following information for each auxiliary data^{DCR048}:

- A reference to the applicable document where the format of the auxiliary data entry is defined
- Whether the data is available On-line
- Whether the data is available on RDM
- Whether it contains packets with a span of validity, as opposed to the packets being valid only at a particular point in time

037 041

Data Description Title		Reference	Available on-line?	Available on RDM?	Span Valid?
ROSETTA					
ATNR	S/C attitude	DDID-H	Yes	Yes	Yes
AGC1	RSI Automatic Gain Control data1 from IFMS ^{DCR 248}	Ref A-9	Yes	Yes	No
AGC2	RSI Automatic Gain Control data2 from IFMS ^{DCR 248}	Ref A-9	Yes	Yes	No
ATPR	S/C attitude, medium term planning	DDID-H	Yes	Yes	Yes
CCHA	Comet Characteristics	DDID-H	Yes	Yes	No
CENV	Cometary Environment	DDID-H	Yes	Yes	No
CKIN	Comet Kinematics	DDID-H	Yes	Yes	No
CONF	Conflict File	RSOC-PI	Yes	Yes	No
D1FD	Doppler 1 Data File (for Flight Dynamics) ^{DCR 141}	FDSICD	Yes	Yes	No
D2FD	Doppler 2 Data File (for Flight Dynamics) ^{DCR 141}	FDSICD	Yes	Yes	No
DOP1	Doppler 1 Data File (for RSI) ^{DCR 141, DCR 153}	FDSICD	Yes	Yes	No
DOP2	Doppler 2 Data File (for RSI) ^{DCR 141, DCR 153}	FDSICD	Yes	Yes	No
DOR_	Direct Operation Request	CRID	Yes	Yes	No
ECF_	Expedite Command File – Operational	CRID	Yes	Yes	No
EVTR	Event File	DDID-H	Yes	Yes	No
FDR_	Flight Dynamics Request	CRID	Yes	Yes	No
G1FD	Flight Dynamics Automatic Gain Control data1 from IFMS ^{DCR248}	Ref A-9	Yes	Yes	No
G2FD	Flight Dynamics Automatic Gain Control data2 from IFMS ^{DCR248}	Ref A-9	Yes	Yes	No
LTVF	Lander TC Verification File	DDID	Yes	Yes	No
MCR_	Memory Checksum Request - Operational	CRID	Yes	Yes	No
MDAF	MTL-DAF	DDID	Yes	Yes	No ^{DCR219}
MDR_	Memory Dump Request - Operational	CRID	Yes	Yes	No

Data Description Title		Reference	Available on-line?	Available on RDM?	Span Valid?
MET_	Meteo[rological] Data File (for RSI) ^{DCR 141, DCR 153}	FDSICD	Yes	Yes	No
MPR_	Memory Patch Request - Operational	CRID	Yes	Yes	No
MSP_	Master Science Plan	DDID	Yes	Yes	No
MTFD	Meteo[rological] Data File (for Flight Dynamics) ^{DCR 141}	FDSICD	Yes	Yes	No
OASW	Orbit and attitude file access software	DDID-H	Yes	Yes	No
ORER	Earth centric first Earth swingby S/C orbit	DDID-H	Yes	Yes	No
ORFR	Earth centric second Earth swingby S/C orbit	DDID-H	Yes	Yes	No
ORGR	Earth centric third Earth swingby S/C orbit ^{DCR268}	DDID-H	Yes	Yes	No
ORHO	Heliocentric Lutetia ^{DCR307} orbit	DDID-H	Yes	Yes	No
ORHR	Heliocentric S/C cruise orbit	DDID-H	Yes	Yes	No
ORHS	Heliocentric Steins ^{DCR307} orbit	DDID-H	Yes	Yes	No
ORHW	Comet Orbit, heliocentric	DDID-H	Yes	Yes	No
ORMR	Mars centric Mars swingby S/C orbit	DDID-H	Yes	Yes	No
OROR	Lutetia ^{DCR307} centric Lutetia ^{DCR307} flyby S/C orbit	DDID-H	Yes	Yes	Yes
ORPR	Medium term planning comet centric S/C orbit	DDID-H	Yes	Yes	No
ORSR	Steins ^{DCR307} centric Steins ^{DCR307} flyby S/C orbit	DDID-H	Yes	Yes	Yes
ORWR	S/C comet centric orbit	DDID-H	Yes	Yes	No
PNAV	Processed NAVCAM Images	DDID-H	Yes	Yes	No
POR_	Payload Operation Request - Operational	CRID	Yes	Yes	No
PORP	Preliminary Payload Operation Request ^{DCR224}	CRID	Yes	Yes	No
PTR_	Pointing Timeline Request ^{DCR224}	Ref A-8	Yes	Yes	No
PTRP	Preliminary Pointing Timeline Request ^{DCR224}	Ref A-8	Yes	Yes	No
RANG	Ranging Data File (for RSI) ^{DCR141, DCR153}	FDSICD	Yes	Yes	No
DCR224					
RGFD	Ranging Data File (for Flight Dynamics) ^{DCR141}	FDSICD	Yes	Yes	No
DCR224					
DCR224					
SOR_	Spacecraft Operation Request	CRID	Yes	Yes	No
MARS EXPRESS ^{DCR325}					
AGC1	RSI Automatic Gain Control data1 from IFMS ^{DCR 248}	DDID	Yes	Yes	No
AGC2	RSI Automatic Gain Control data2 from IFMS ^{DCR 248}	DDID	Yes	Yes	No
ATNM	Predicted / reconstituted S/C attitude	DDID-H	Yes	Yes	Yes
D1FD	Doppler 1 Data File (for Flight Dynamics) ^{DCR 141}	FDSICD	Yes	Yes	No

Data Description Title		Reference	Available on-line?	Available on RDM?	Span Valid?
D2FD	Doppler 2 Data File (for Flight Dynamics) ^{DCR 141}	FDSICD	Yes	Yes	No
DMOP	Detailed Mission Operations File	DDID-J	Yes	Yes	No
DOP1	Doppler 1 Data File (for RSI) ^{DCR 141}	FDSICD	Yes	Yes	No
DOP2	Doppler 2 Data File (for RSI) ^{DCR 141}	FDSICD	Yes	Yes	No
DOR_	Direct Operation Request	CRID	Yes	Yes	No
DSOP	Detailed Science Operations File	DDID-J	Yes	Yes	No
ECF_	Expedite Command File	CRID	Yes	Yes	No
EVTF	Event File. Long Term Planning	DDID-H	Yes	Yes	No
EVTM	Event File.	DDID-H	Yes	Yes	No
FDR_	Flight Dynamics Request	CRID	Yes	Yes	No
FDSW	FORTRAN Software Source Code Files	DDID	Yes	Yes	No
FECS	Preliminary Events and Communications Skeleton	POSFDS	Yes	Yes	No
FTL	Flight Dynamics Timeline	POSFDS	Yes	Yes	No
G1FD	Flight Dynamics Automatic Gain Control data from IFMS ^{DCR248}	DDID-H	Yes	Yes	No
G2FD	Flight Dynamics Automatic Gain Control data from IFMS ^{DCR248}	DDID-H	Yes	Yes	No
MCR_	Memory Checksum Request	CRID	Yes	Yes	No
MDAF	MTL-DAF	tbd	Yes	Yes	No ^{DCR219}
MDR_	Memory Dump Request	CRID	Yes	Yes	No
MET_	Meteo[rological] Data File (for RSI) ^{DCR 141}	FDSICD	Yes	Yes	No
MPR_	Memory Patch Request	CRID	Yes	Yes	No
MTFD	Meteo[rological] Data File (for Flight Dynamics) ^{DCR 141}	FDSICD	Yes	Yes	No
OASW	Orbit and attitude file access software (various)	DDID-H	Yes	Yes	No
ORHM	S/C orbit, cruise, heliocentric	DDID-H	Yes	Yes	No
ORMF	S/C orbit, operational, Mars centric. Long Term Planning	DDID-H	No ^{DCR117}	Yes	No
ORMM	S/C orbit, operational, Mars centric	DDID-H	Yes	Yes	Yes
OWLT	One-Way Light Time File	FDSICD	Yes	Yes	No
POR_	Payload Operation Request	CRID	Yes	Yes	No
PTR	Pointing Timeline Request (TBD)	POSFDS	Yes	Yes	No
RANG	Ranging Data File (for RSI) ^{DCR141}	FDSICD	Yes	Yes	No
RGFD	Ranging Data File (for Flight Dynamics) ^{DCR141}	FDSICD	Yes	Yes	No
RMOP	Restituted Detailed Mission Operations File	MPS-MCS	Yes	Yes	No
RSOP	Restituted Detailed Science Operations File	MPS-MCS	Yes	Yes	No
DCR232					
SOR_	Spacecraft Operation Request (OPE)	CRID	Yes	Yes	No
SOR_	Spacecraft Operation Request (MPS)	CRID	Yes	Yes	No
SPL_	Scenario Parameter List (TBD)	tbd	Yes	Yes	No

Data Description Title		Reference	Available on-line?	Available on RDM?	Span Valid?
STOM	Star occultations	DDID-H	Yes	Yes	No
VILM	Lander Visibility ^{DCR325}	DDID-H	Yes	Yes	No
VENUS EXPRESS ^{DCR325, 343}					
AGC1	RSI Automatic Gain Control data1 from IFMS	DDID	Yes	Yes	No
AGC2	RSI Automatic Gain Control data2 from IFMS	DDID	Yes	Yes	No
ATNV	Predicted / reconstituted S/C attitude	DDID-H	Yes	Yes	Yes
ATPV	Medium Term Attitude prediction	DDID-H	Yes	Yes	Yes
D1FD	Doppler 1 Data File (for Flight Dynamics)	FDSICD	Yes	Yes	No
D2FD	Doppler 2 Data File (for Flight Dynamics)	FDSICD	Yes	Yes	No
DMOP	Detailed Mission Operations File	DDID-J	Yes	Yes	No
DOP1	Doppler 1 Data File (for RSI)	FDSICD	Yes	Yes	No
DOP2	Doppler 2 Data File (for RSI)	FDSICD	Yes	Yes	No
DOR_	Direct Operation Request	CRID	Yes	Yes	No
DSOP	Detailed Science Operations File	DDID-J	Yes	Yes	No
ECF_	Expedite Command File	CRID	Yes	Yes	No
EVTF	Event File. Long Term Planning	DDID-H	Yes	Yes	No
EVTP	Event File. Medium Term Planning	DDID-H	Yes	Yes	No
EVTV	Event File.	DDID-H	Yes	Yes	No
FDR_	Flight Dynamics Request	CRID	Yes	Yes	No
FDSW	FORTTRAN Software Source Code Files	DDID	Yes	Yes	No
FECS	Preliminary Events and Communications Skeleton	SOIA	Yes	Yes	No
FTLV	Flight Dynamics Timeline	SOIA	Yes	Yes	No
FSCV	Flight Dynamics Constants File	SOIA	Yes	No	No
G1FD	Flight Dynamics Automatic Gain Control data from IFMS	DDID-H	Yes	Yes	No
G2FD	Flight Dynamics Automatic Gain Control data from IFMS	DDID-H	Yes	Yes	No
MCR_	Memory Checksum Request	CRID	Yes	Yes	No
MDAF	MTL-DAF	CRID	Yes	Yes	No
MDR_	Memory Dump Request	CRID	Yes	Yes	No
MET_	Meteo[rological] Data File (for RSI)	FDSICD	Yes	Yes	No
MPR_	Memory Patch Request	CRID	Yes	Yes	No
MTFD	Meteo[rological] Data File (for Flight Dynamics)	FDSICD	Yes	Yes	No
OASW	Orbit and attitude file access software (various)	DDID-H	Yes	Yes	No
ORHV	S/C orbit, cruise, heliocentric	DDID-H	Yes	Yes	No
ORVF	S/C orbit, operational, Venus centric. Long Term Planning	DDID-H	No	No	No
ORVV	S/C orbit, operational, Venus centric	DDID-H	Yes	Yes	Yes
OWLT	One-Way Light Time File	FDSICD	Yes	Yes	No

Data Description Title		Reference	Available on-line?	Available on RDM?	Span Valid?
POR_	Payload Operation Request	CRID	Yes	Yes	No
PTRV	Pointing Timeline Request	SOIA	Yes	Yes	No
RANG	Ranging Data File (for RSI)	FDSICD	Yes	Yes	No
RGFD	Ranging Data File (for Flight Dynamics)	FDSICD	Yes	Yes	No
RMOP	Restituted Detailed Mission Operations File	MPS-MCS	Yes	Yes	No
RSOP	Restituted Detailed Science Operations File	MPS-MCS	Yes	Yes	No
SAAV	Sun Aspect Angles File	SOIA	Yes	Yes	No
SOR_	Spacecraft Operation Request (OPE)	CRID	Yes	Yes	No
SOR_	Spacecraft Operation Request (MPS)	CRID	Yes	Yes	No
SPL_	Scenario Parameter List (TBD)	tbd	Yes	Yes	No
STOV	Star occultations	DDID-H	Yes	Yes	No
TMSV	Trajectory Manoeuvre Slot Schedule	SOIA	Yes	Yes	No
UCAV	User Custom Attitude File	SOIA	Yes	No	No

Note: The LTVF includes a bit pattern of a Lander Operations Request. It is going to be created manually on request only. It is not foreseen to be created during the Comet Phase.^{DCR 075 DCR 206}

For the on-line delivery, auxiliary data is requested using the same mechanism as for telemetry data. The various files of auxiliary data available are also listed in Appendix A, together with their corresponding data source/type mnemonics and ADID. They are referenced in the same manner as telemetry data streams, i.e. with a data source and data type mnemonic (the type always being AUX⁰⁸⁷).^{038 048}

The catalogue entry for an auxiliary data source is the same as for the telemetry data sources.

Many of the auxiliary files are produced in both a readable (ASCII) format and non-readable (BINARY) format.^{DCR 206} In these cases both files are returned (zipped together) when the item is requested. For more details the reader is referred to the appropriate appendix ref A-4.⁰⁶⁵

13. Appendix F: Standard Formatted Data Units (SFDUs)

13.1 Overview of the Standard Formatted Data Unit (SFDU) Concept

The Standard Formatted Data Unit (SFDU) concept provides standardised techniques for the automated packaging and interpreting of data products. It puts no constraint on the format of the user data, and can thus accommodate standard formats developed by other organisations or user communities. It operates in a heterogeneous environment.

The SFDU concept has been developed to address some of the problems associated with information interchange. It offers the following:

- A low overhead, internationally recognised data labelling scheme which permits self-identification of data objects;
- Standard techniques for providing complete and unambiguous data descriptions;
- Procedures for registration and administration of these data descriptions;
- Techniques for packaging labelled data objects into larger data products;
- Sufficient standardisation to allow the development of generic software to support the retrieval, access, parsing and presentation of SFDU data objects, while allowing those objects to have individual formats to satisfy particular application and user needs.

13.2 SFDU Building Blocks - The Label-Value-Object

The basic SFDU building block is comprised of a LABEL field and a VALUE field, and is referred to as a Label-Value-Object (LVO). This structure is the fundamental structural element used to build SFDUs. It is shown below. This basic element is deemed to be a stream of octets, the ASCII codes and octet and bit ordering used is described in Appendix G. All data delivered by the DDS will use these codes and octet/bit numbering scheme).

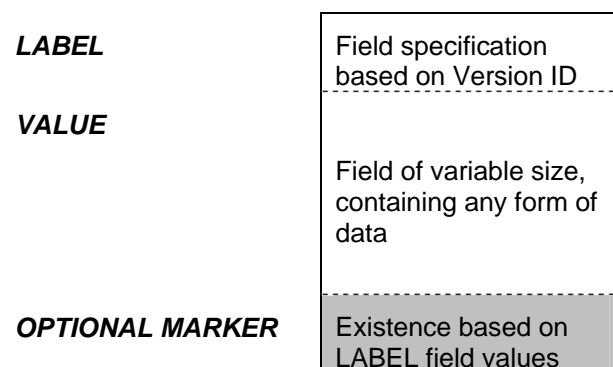

The VALUE field may contain any form of data that can be described by a user defined data description or by a CCSDS recognised data description. The method used to delimit this field, and a description of the data in this field, are identified through the associated LABEL sub-field.

The optional marker field is required by some delimitation techniques to delimit the VALUE field.

The SFDU LABEL has a fixed 20 octet length, which is split into a number of sub-fields as shown below (applicable to Version ID = 1, 2 and 3).

CAID (ADID 1 of 2)	Version ID	Class ID	Delim. ID	Spare	DDID (ADID 2 of 2)	Delimitation Parameter	LABEL sub-field
0-3	4	5	6	7	8-11	12-19	Octet number

The Version ID sub-field dictates the format and meaning of the other sub-fields, in all the data structures defined in this document the Version ID is always equal to "3" (ASCII character "3"). (Version IDs "1" and "2" are for compatibility with older SFDU structures only)

For Version ID = "3", the other sub-fields have the following meaning and values.

- **Control Authority Identifier (CAID):** The Control Authority Identifier contains the identifier of the organisation that has assigned the DDID to the information describing the VALUE field. This Control Authority Office has the responsibility for maintaining this data description information and supplying it to user. The CAID is the first part of the ADID.
- **Data Description Identifier (DDID):** The Data Description Identifier contains the identifier of the data description information held at the Control Authority Office, as identified by the CAID. The DDID is the other part of the ADID.
- The combination of the CAID and the DDID is called the **Authority and Description Identifier (ADID)**. The ADID uniquely identifies the data description information that applies to the associated VALUE field.
- **Class ID:** The Class ID indicates the kind of data contained in the VALUE field following the LABEL. The Class IDs can be split into three basic categories, as shown below. The Structure Classes handle the packaging of LVOs, the Service Classes provide CCSDS service mechanisms and the Data Classes contain the actual user data.

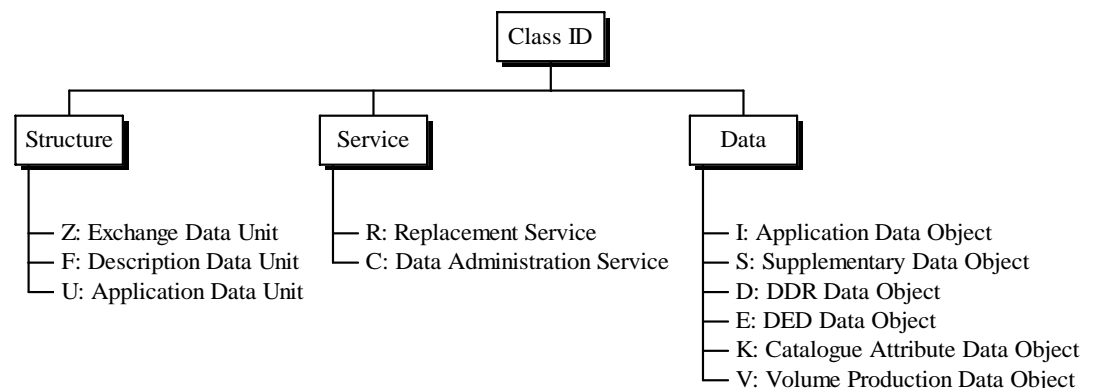

- **Delimitation ID:** This field defines how the size of the VALUE field is determined. The possible values for this field as used in the SFDU structures defined in this document are (for a full list see R-4):
 - ASCII character "B" :^{DCR 032} This indicates that the length of the VALUE field is specified in the Delimitation Parameter sub-field in unsigned binary.

- ASCII character "F" : This indicates that the VALUE field is complete when a single End-of-File is encountered in the input stream. The Delimitation Parameter sub-field must contain the ASCII string "00000001"
- **Delimitation Parameter:** This sub-field is used to provide any parameters that are required to complete the delimitation of the VALUE field. For example, in the two delimitation techniques used here, for Delimitation ID = "A", this field contains the VALUE field length represented by an eight octet decimal ASCII string, for Delimitation ID = "F" no further parameter is required as one may not have more than one EOF on random access media, therefore this field is set to the ASCII string "00000001".
- **Spare:** This is a spare octet which is set to the RA numeric character 0 (zero).

13.3 Overview of CCSDS Defined ADIDs

There are two types of recognised ADIDs:

1. Those defined by the CCSDS, appearing in CCSDS Recommendations, and beginning with the four characters "CCSD". These are referred to as CCSDS ADIDs.
2. Those defined by SFDU users, typically through data description registration with Control Authority organisations (See R-5). These are referred to as non-CCSDS ADIDs.

While it is expected that most ADIDs shall be assigned by Control Authority Offices to data descriptions prepared by data producers, there are a number of standard descriptions that have been defined by the CCSDS for general use within the SFDU domain. These descriptions are assigned CCSDS ADIDs and they appear in CCSDS Recommendations. The CCSDS ADIDs that are used in this document are described below.

ADID	Usage
CCSD0001	The VALUE field contains one or more LVOs
CCSD0002	The VALUE field is expressed in ASCII Encoded English (See R-9)
CCSD0003	VALUE field contains several "parameter=value" (PVL) statements that optionally label external data objects before logically including them in the current structure
CCSD0004	VALUE field contains one or more "parameter=value" (PVL) statements that identify a data description package and optionally reference other metadata objects
CCSD0005	VALUE field contains one or more LVOs, making up a Description Data Unit (DDU)
CCSD0006	The VALUE field is expressed in Parameter Value Language (PVL, see R-8)
CCSD0009	VALUE field contains one or more LVOs, making up an Application Data Unit (ADU)

13.4 SFDU Structuring

SFDU data products are constructed from the basic LVO in one of two ways. If the VALUE field of the LVO contains purely user data it is termed a "Simple LVO". If, on the

other hand, the VALUE field of the LVO contains purely LVOs, it is termed a "Compound LVO".

SFDU products are always packaged in a special kind of Compound LVO called the Exchange Data Unit (EDU). Only EDUs may be interchanged between systems. Special types of Compound LVOs are also provided to package together application data (the Application Data Unit (ADU)) and data description data (the Description Data Unit (DDU)). The CCSDS defined categories of Simple and Compound LVOs, which vary depending upon the type of data or LVOs respectively that they contain, are detailed in the following sections.

13.4.1 Simple LVOs

Data in a Simple LVO may be viewed as belonging to one of the following categories:

- Application data; that is the data which is of primary interest (typically measurements or data derived from measurements);
- Supplementary data; that is data that is considered to enhance the understanding of the associated data;
- Data description information, telling how the application data are formatted, including such details as size of the data fields, numerical or other representations used and the meanings of the fields;
- Data cataloguing and/or data production information, giving certain overall attributes of the data, for example, date of generation, instrument used, instrument location, general information about the way the data was collected, relayed or processed, etc .

Any one of these types of data may be contained in the VALUE field of a single LVO.

13.4.2 Compound LVOs

Compound LVOs are LVOs which contain within their VALUE field a sequence of one or more LVOs, each of which can be a Simple or Compound LVO itself. LVOs that are contained in the VALUE field of a Compound LVO are deemed to be one "Structure Level" lower than that of the containing Compound LVO. If any of these contained LVOs are themselves a Compound LVO then they will themselves contain a sequence of LVOs; this sequence is at the next lower "Structure Level". This process may continue indefinitely leading to a succession of structure levels. This process is the way in which LVOs are nested. There are no rules dictating the number or order of Compound and Simple LVOs within a data product, except that there must be at least one Simple LVO at the lowest structure level of any Compound LVO (i.e. a Compound LVO cannot have a VALUE field of zero length).

There are three types of Compound LVOs; there is the Exchange Data Unit (EDU), and two particular structures which must be packaged within an EDU. These are the Application Data Unit (ADU), which explicitly does not contain any data description information, and the Description Data Unit (DDU), which can contain only data description information.

13.4.2.1 Exchange Data Unit (EDU)

Typically an SFDU data product consists of not only the data (e.g. an image, a set of measurement samples), but also all the supporting metadata that is needed to understand the data product. Any type of data may be contained within an Exchange Data Unit (EDU). SFDU data MUST be exchanged in the form of an EDU.

13.4.2.2 Application Data Unit (ADU)

The purpose of an ADU is to package application data instances (e.g. measurement samples) together with any necessary ancillary data (e.g. sampling rate) and identification data (e.g. catalogue information), and to explicitly exclude any data description information. For Rosetta and Mars Express data delivery, each day of data from each instrument, from each spacecraft shall be contained within its own ADU, with a relevant catalogue LVO.

13.4.2.3 Description Data Unit (DDU)

A Description Data Unit is characterised as follows:

- It carries the description of a data object (typically syntactic information such as the format of a sample, and semantic information such as the name and units of the components of the sample);
- It explicitly links the data description to the data object to which it applies;
- It does not include any application data instances.

Each valid category of data is assigned a unique Authority and Data Description Identifier (ADID) by the Control Authority (see R-5), which shall be at ESOC. Control Authorities provide the important administrative function of assigning ADIDs and collecting and validating the associated data descriptions.

In the SFDU concept the ADID points to a Data Description, as illustrated in the general example below. In the very simple approach being followed for Rosetta it is proposed that, in general, the data descriptions be expressed in ASCII Encoded English, i.e. no automated interpretation of data packets is foreseen.

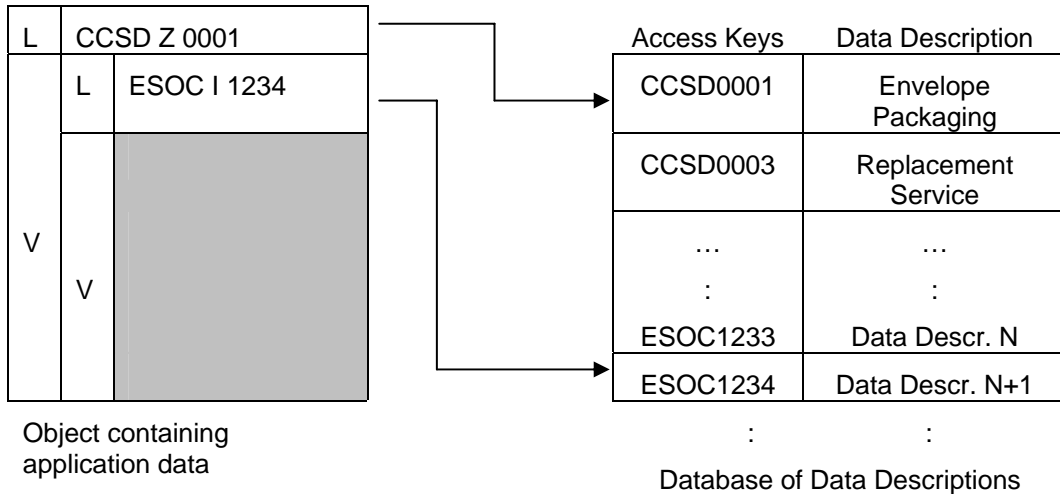

Thus ESOC, as Control Authority, shall have registered English language data descriptions of all data. The next figure illustrates schematically what such a description looks like. The description is in another format of EDU. All these descriptions shall be provided on the RDM with the telemetry and auxiliary data, therefore the user shall have a wholly complete description of all data received.

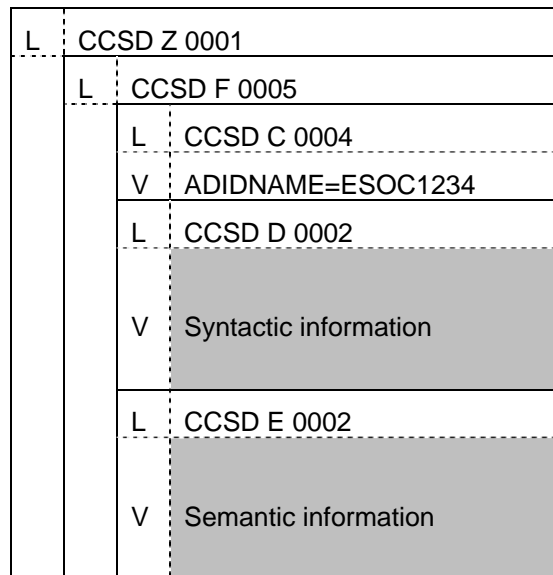

The main points to note are:

- The whole SFDU product is enclosed within a Class Z LVO (an EDU), indicating that the VALUE field can contain LVOs of any other class;
- The Class F LVO indicates that everything enclosed within it is part of a data description registration package. This is mandatory to register any data description package (see R-4);
- The Class C LVO is used in its simplest form, and has a single Parameter Value Language (PVL) statement within its VALUE field, for example ADIDNAME=ESOC1234;. This PVL statement specifies the ADID under which the data description shall be registered. White space is also allowed within the Class C LVO VALUE field;
- The VALUE field of the Class D or Class E LVOs contain the actual data description. The ADID of this Class D is CCSD0002, this specifies that the VALUE field is represented in English ASCII Text. Each Class D LVO VALUE field shall therefore contain a conventional English language Interface Control Document.

As well as supplying these data description on the RDM, the Control Authority, ESOC, shall maintain a database of data descriptions. In the database, each description shall be keyed on the ADID of the data it describes.

13.5 EDU Structure Diagram

The four structures that have been illustrated in the previous section are the Simple Label-Value-Object (LVO), the Exchange Data Unit (EDU), the Application Data Unit (ADU) and the Description Data Unit (DDU). These structures may be packaged together as indicated in the structure diagram below. Not all the components on the right of the := have to be included in all EDUs, but at least one Simple LVO must be present. The packaging is hierarchical with the highest level object being an EDU.

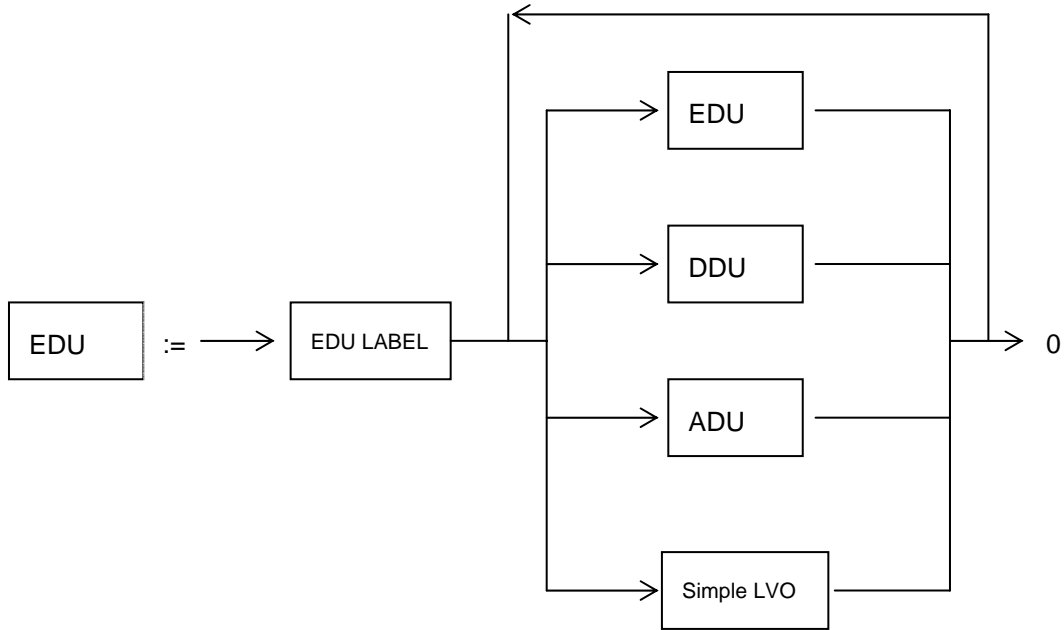

13.6 Packaging Techniques

13.6.1 Envelope Packaging

Envelope Packaging is the simplest form of SFDU packaging and is used when all the data/LVOs to be packaged reside in the same physical file. The idea is shown below, which shows the simplest case, in which an EDU contains one LVO of application data, which could, for example, be a transfer frame of telemetry data. A more elaborate example, showing the envelope packaging of a "bundle" of telemetry packets is shown overleaf.

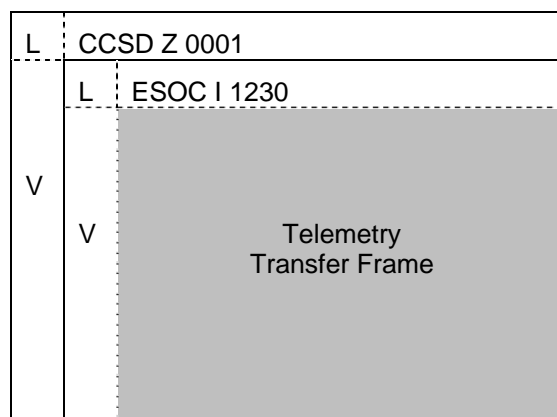

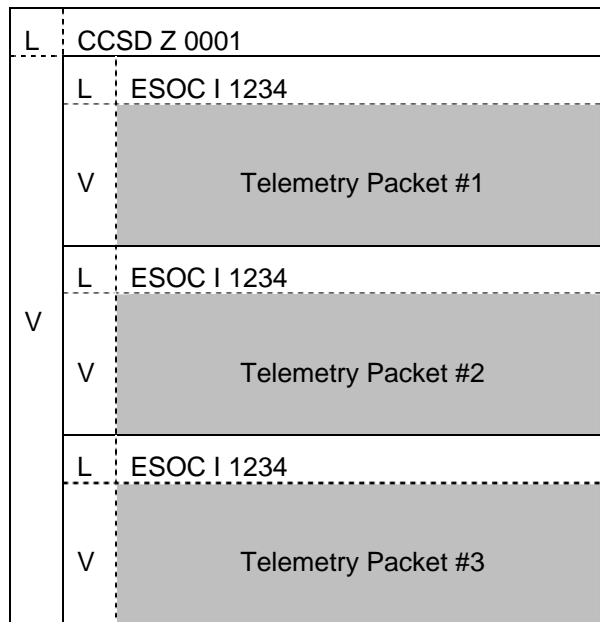

13.6.2 Referencing Technique - the Replacement Service

The referencing technique is provided to include data units in a product even if those units are not stored contiguously with the rest of the product. This is realised by means of an LVO with Class ID = R, which contains the reference information in its VALUE field in the form of Parameter Value Language (PVL) statements (see R-9). The concept is shown below.

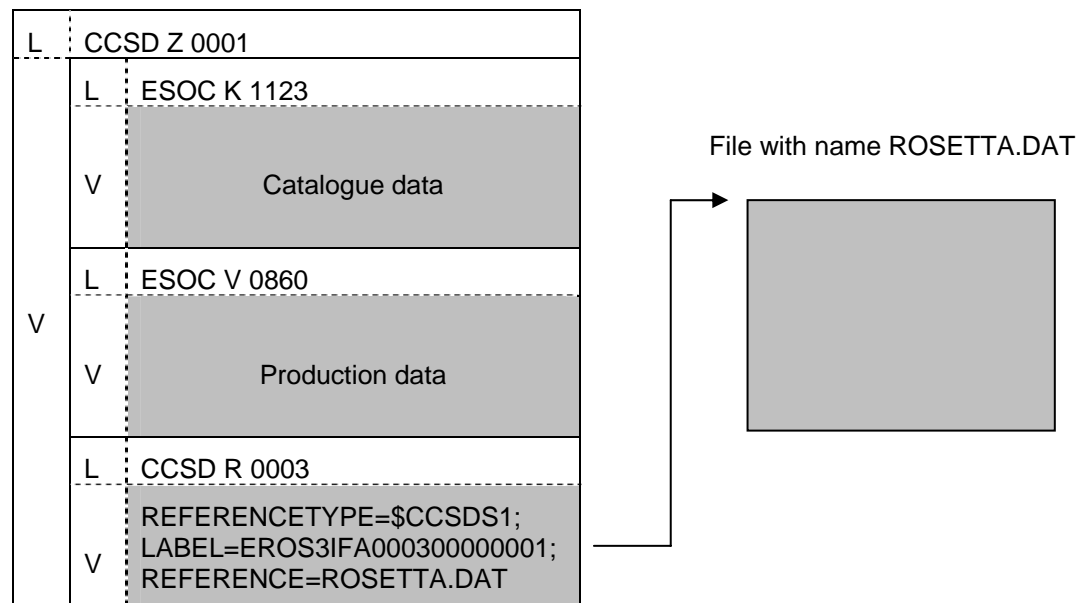

In this EDU, the data file (a sequence of telemetry frames) is stored on the same media, but not in the same file as the rest of the SFDU product which contains the associated catalogue and production data, the LVO with Class ID = R is envelope packaged in the

EDU and references a file called ROSETTA.DAT. The PVL statements in the LVO with Class ID = R have the following meanings:

REFERENCETYPE=\$CCSDS1: this statement defines the file naming convention for the **REFERENCE** statement. In the case of Rosetta and MEX, the CCSDS proposed canonical form, \$CCSDS1, will be used.

LABEL=caid-v-c-d-s-ddid-xxxxxxx: this statement provides a 20 octet string that is used to label the remote data file. The string has the same specification as for a standard LABEL.

REFERENCE=filename: this statement provides the actual referenced filename, the format of this depends upon the **REFERENCETYPE** parameter value.

Although there may be only one **REFERENCETYPE** statement in any one Class R LVO, and it must be the first statement, there may be any number of **LABEL** and **REFERENCE** statements, so that many files may be referenced from one Class R LVO.

14. Appendix G: Physical Data Nomenclature Conventions

14.1 ASCII Codes Definition

This Appendix defines the ASCII code set that is used for SFDUs and also highlights the codes that comprise the Restricted ASCII character that is used in the LABEL field of an LVO.

A code is a correspondence between a symbol and a number of digits of a number system. The American Standard Code for Information Interchange (ASCII) is a seven-bit code also known as the USA Standard Code for Information Interchange (USASCII). The latest updated American National Standards Institute ANSI-X3 standard for this is ANSI X3.4-1977. This code has been incorporated into the ISO code of the same nature (ISO 646-1983) which includes other symbols and alphabets. Since the ISO code is an eight-bit code, the ASCII code is embedded in an eight-bit field in which the higher order bit is set to zero. The Restricted ASCII set of characters (denoted here by a * next to the code) is used by the CCSDS Recommendation. The primary reference to be used should be ISO 646-1983.

The ASCII and Restricted ASCII or RA codes are given below. (*The code for each character (Char) is given in decimal (Dec), and hexadecimal (Hex).*)

Char	Dec	Hex
NUL	0	00
SOH	1	01
STX	2	02
ETX	3	03
EOT	4	04
ENQ	5	05
ACK	6	06
BEL	7	07
BS	8	08
HT	9	09
LF	10	0A
VT	11	0B
FF	12	0C
CR	13	0D
SO	14	0E
SI	15	0F
DLE	16	10
DC1	17	11
DC2	18	12
DC3	19	13
DC4	20	14
NAK	21	15
SYN	22	16
ETB	23	17
CAN	24	18

Char	Dec	Hex
sp	32	20
!	33	21
"	34	22
#	35	23
\$	36	24
%	37	25
&	38	26
'	39	27
(40	28
)	41	29
*	42	2A
+	43	2B
,	44	2C
-	45	2D
.	46	2E
/	47	2F
0	48	30
1	49	31
2	50	32
3	51	33
4	52	34
5	53	35
6	54	36
7	55	37
8	56	38

Char	Dec	Hex
@	64	40
* A	65	41
* B	66	42
* C	67	43
* D	68	44
* E	69	45
* F	70	46
* G	71	47
* H	72	48
* I	73	49
* J	74	4A
* K	75	4B
* L	76	4C
* M	77	4D
* N	78	4E
* O	79	4F
* P	80	50
* Q	81	51
* R	82	52
* S	83	53
* T	84	54
* U	85	55
* V	86	56
* W	87	57
* X	88	58

Char	Dec	Hex
`	96	60
a	97	61
b	98	62
c	99	63
d	100	64
e	101	65
f	102	66
g	103	67
h	104	68
i	105	69
j	106	6A
k	107	6B
l	108	6C
m	109	6D
n	110	6E
o	111	6F
p	112	70
q	113	71
r	114	72
s	115	73
t	116	74
u	117	75
v	118	76
w	119	77
x	120	78

Char	Dec	Hex
EM	25	19
SUB	26	1A
ESC	27	1B
FS	28	1C
GS	29	1D
RS	30	1E
US	31	1F

Char	Dec	Hex
9	57	39
:	58	3A
;	59	3B
<	60	3C
=	61	3D
>	62	3E
?	63	3F

Char	Dec	Hex
Y	89	59
Z	90	5A
[91	5B
\	92	5C
]	93	5D
^	94	5E
_	95	5F

Char	Dec	Hex
y	121	79
z	122	7A
{	123	7B
	124	7C
}	125	7D
~	126	7E
DEL	127	7F

14.2 Bit and Octet Numbering Conventions

In this document, the following convention is used to identify each octet (8-bit field) in an N-Octet field:

The first octet in the field (to be transferred) will be drawn in the most left justified position and will be defined to be "Octet 0". The following octet will be defined as "Octet 1" and so on, up to "Octet N-1". When the field is used to express a numerical value, the Most Significant Octet (MSO), shall be the first octet of the field, i.e., "Octet 0". The sequence of decreasing value will be Octet 1 to Octet N-1.

According to the CCSDS convention, the Most Significant Bit (MSB) of any octet shall be the first bit transmitted and it shall be drawn in the most left justified position and designated as "Bit 0". The transmission sequence shall go from MSB to the Least Significant Bit (LSB).

15. Appendix H: Data Delivery Flight Dynamics Products

This is provided as a separate document (A-4).

16. Appendix I: Request Dialogue XML Schema

This is provided as a separate document.(A-7)

17. Appendix J: Data Delivery Mars/Venus^{DCR210} Express MPS Products

Appendix E provides the full list of auxiliary data delivered for Mars Express.

The files related to the Mars/Venus Express Mission Planning Systems are described in the OCDs MEX-ESC-RS-5611, chapter 12.5 and VEX-ESC-RS-5007, chapter 12.5 respectively.^{DCR210}

18. Appendix K: MCS Products

This appendix defines the products that originate in the MCS.

18.1 MCS Telemetry Packets

This section describes telemetry packets assigned by the Mission Control System.

18.1.1 Externally Generated Packets Reassigned by MCS

This section describes telemetry packets generated externally to the MCS (by the Spacecraft) which are reassigned to a specific APID/Type/Subtype ID.

The structure and identification of this packet is defined by the TM/TC ICD^{DCR218} and definitions exist within the source database.

Where no indication is provided in the externally generated data, internal telemetry packets are identified by:

- APID = 1966
- Type = 190

For reference, the following table defines internal Telemetry Packets containing externally generated data.

Packet Description	APID	TYPE	SUBTYPE
Telemetry Packet - Bad	1966	190	30
Telemetry Packet - Idle	-	190	0
Telemetry Packet - RICE Compressed	-	190	-
Telemetry Packet - Source Packet	-	-	-
Telemetry Packet - Time Packet	-	190	-
Telemetry Packet - undefined in database	1966	190	38
Telemetry Packet - Wavelet Compressed	-	-	-
Transfer Frame - Bad	1966	190	20
Transfer Frame - Good	1966	190	21
Transfer Frame - Idle	1966	190	29

Note: '-' indicates value defined externally in received data.

18.1.2 Telemetry Packet Generated by MCS

This section describes telemetry packets generated within the Mission Control System.

In general, all packets generated by the MCS are stored without a Source Packet Header and consist of:

SCOS-2000 TM Packet Header	Packet Data Field
----------------------------	-------------------

For reference, the following table defines internal Telemetry Packets generated by the Mission Control System.^{DCR205, DCR211}

Packet Description	APID	TYPE	SUBTYPE
Time Correlation Coefficient Packets	1966	190	40
Telemetry Constants Packet	1966	190	0

18.1.2.1 Time Correlation Coefficient Packets

Time correlation coefficient packets contain the information necessary to enable the UTC time of a packet to be obtained from its OBT. The following contains a description of the end-to-end processing involved in generating the time correlation packets, as well as a description of the packet contents.^{DCR214}

The procedures for carrying out Spacecraft Time correlation are specified in the ESA Packet Telemetry standard (Applicable Document A-2) and the relevant section reproduced here

18.1.2.1.1 Spacecraft Time Correlation Procedures. (From Section 7.4 of Applicable Doc. A-2)

On board the spacecraft, the contents of the Spacecraft Elapsed Time clock are sampled at the instance of occurrence of the leading edge of the **first bit of the Attached Synchronisation Marker of that telemetry Transfer Frame of Virtual Channel '0' with a Virtual Channel Frame Count '0'**. This time sample shall then be placed into the standard Spacecraft Time Source Packet and telemetered to **ground** before the Frame Counter of Virtual Channel '0' has counted 255 more frames, so as to avoid ambiguity.

Should this sampling rate (intervals of 256 Frames of Virtual Channel '0') prove too low for the mission requirements, it is permissible to sample the spacecraft clock contents at intervals of 128, 64, 32, 16, 8, 4, 2 or 1 frame(s) of Virtual Channel '0', by choice. Consequently the time sample shall be telemetered to ground before the selected number of Frames of Virtual Channel '0' have elapsed (128, 64, 32, 16, 8, 4, 2 or 1, all counts starting from Virtual Channel Frame Count '0').

The ground data capture system shall;

- a) accurately time-tag the instant of reception of the same first bit of the Attached Synchronisation Marker of the Virtual Channel '0' Transfer Frame with a Virtual Channel Frame Count '0'. The time standard used will be the CDS-coded UTC;
- b) extract the standard Spacecraft Time Source Packet and collect the CUC-coded time sample.

Thus, a correlation between the Spacecraft Elapsed Time and the UTC reference on ground shall be established which can be used:

- on ground, to transform the Spacecraft Elapsed Time information contained in the source Packets into UTC information;
- on board the spacecraft, to achieve directly the same service as on the ground.

18.1.2.1.2 Rosetta/MEX/VEX^{DCR325} Implementation

The design of the Rosetta, MEX, and VEX^{DCR325} spacecraft onboard systems is such that it is possible to select the sampling rate at which the standard Spacecraft Time Source Packet is generated to be one of every 256, 128, 64, 32 or 16 VC0 frames.

All telemetry frames on reception at the groundstation are time stamped with the current UTC (obtained from the station clock which is synchronised with UTC), this is called the Earth Reception Time (ERT).. These frames are then routed to the control system at ESOC. On arrival the packetiser (i.e. the application responsible for extracting the source packets from the received time frames) extracts the ERT timestamp of every VC0 "zeroth" frame (i.e. the frame at whose leading edge bit the timestamp contained in the next standard Spacecraft Time Source Packet was generated). The extracted ERT then has 3 correction factors applied to it;

1. the first is to remove the delay between the downlinked frame arriving at the antenna and it actually reaching the equipment where the ERT is timestamped on the frame. This correction is composed of two elements, a fixed delay (which varies between groundstations and is determined by measurements) and a variable delay which depends on bit rate and is the same for all groundstations,
2. the second correction is to remove the propagation delay, i.e. the time taken for the signal to travel from the spacecraft to the groundstation antenna. The appropriate correction is obtained from the predictions contained in the Flight Dynamics "One Way Light Time" (OWLT) file,
3. the third is to remove the delay in processing the frame on the spacecraft. This correction is composed of two elements a fixed delay plus a variable delay which is bit-rate dependent.

After the above corrections have been applied to the ERT what is obtained is effectively the UTC at which standard Spacecraft Time Source Packet was generated onboard the spacecraft. This time is then stored internally by the Packetiser. When the next standard Spacecraft Time Source Packet arrives the Packetiser uses this, along with the stored, generation UTC to create a "Time Telemetry" Packet (Type 190, Subtype 0, Apid 0, P1 0, P2 0) which contains both the spacecraft time and the UTC at which it was generated. These packets are then distributed to the system and filed.

The actual generation of the Time Correlation Coefficients packet is instigated manually by the Flight Control Team who have the ability to specify a time range from which the Time Telemetry Packets should be used to obtain a correlation. Once the applicable Time Telemetry Packets from the specified time range have been extracted from the archive a least squares fit is calculated to obtain the coefficients necessary to convert the OBT in the source packets to UTC. Once the appropriate coefficients have been calculated the FCT can then either reject the obtained correlation, or accept it. If the obtained correlation is accepted a validity start time is specified which is the time from which that correlation is valid, i.e. is used to derive the UTC timestamps from the OBT time contained in the source packets. A time correlation remains valid until the next time correlation packet is generated.

It should be noted that as data can be stored on board the spacecraft the time correlation used to timestamp any particular packet is not necessarily the current correlation since the system will actually use the correlation that was valid for the OBT contained in the source packet.

For Rosetta, MEX, and VEX the gradient of the obtained time correlation should be nominally 1, in practise there will be small deviations from this. Any time correlation packet which is found to contain a gradient substantially different from 1 should be treated with caution.

18.1.2.1.3 Time Correlation Packet Structure

It must be noted that the Time Correlation Packet is NOT a spacecraft source packet since it is generated internally by the control system. Consequently the structure of this packet does not conform to that of spacecraft generated TM packets.

The structure of the packets is as shown in the following diagram, note that the byte order is “big-endian”, i.e. the most significant byte has the lowest address (the word is stored “big-end-first”);

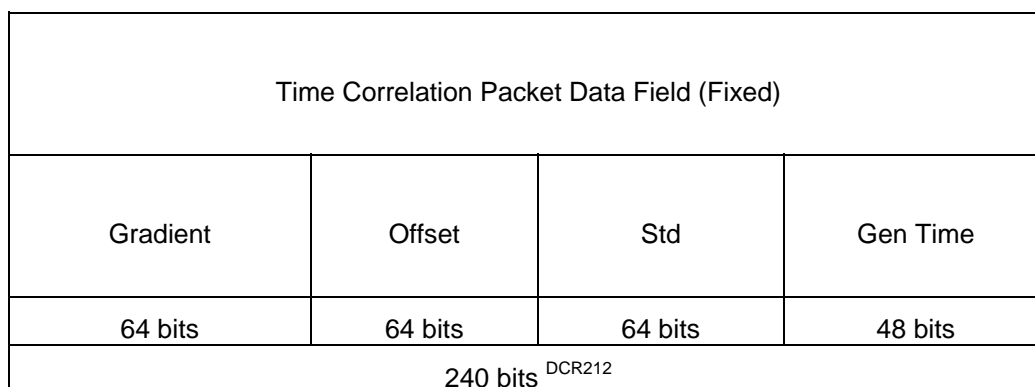

The structure and meaning of the various fields are as follows;

Field Name	Size (bits)	Param type ^{DCR213}	Description
Gradient	64	IEEE Double Format	'Gradient' value of Coefficients pair
Offset	64	IEEE Double Format	'Offset' value of Coefficients pair
Std	64	IEEE Double Format	Standard Deviation value associated with the Coefficients pair
Gen Time	48	CCSDS CUC format	Generation Time of the Coefficients The format of this is as described in Ref R-6 where there is no p-field and the t-field is composed of 4 bytes coarse time and 2 bytes fine time.

It should be noted that for Time Correlation Coefficient packet the SCET contained in the DDID header (see Section 7.6.2) contains the time at which the contained time correlation became valid.

18.1.2.1.4 Meanings of Time Quality Flag

The algorithm for deriving the calibrated timestamp (i.e. the SCET contained in the DDID header, see Section 7.6.2) and the Time Quality is summarised below. In particular, they take into account the On-Board Time (OBT) as contained in the TM source packet generated by the spacecraft and the Earth Reception Time (ERT) of the carrier transfer frame.

Firstly the validity of the OBT is determined by looking at its top bit. If the top bit of the OBT is set, the OBT is invalid. This allows the Time Quality to be derived as follows.

Value	Meaning	Description
0	Good	The OBT is valid and the calibrated time is calculated from the

OBT using the appropriate time correlation.

- | | | |
|---|------------|--|
| 1 | Inaccurate | The OBT is invalid, and the packet was down linked in VC0. In this case the timestamp is set to the ERT of the VC0 frame minus the propagation, on-board and on-ground delays as described previously. |
| 2 | Bad | The OBT is invalid, and the packet was down linked in VC1. In this case the timestamp is set to the ERT of the VC1 frame minus the propagation, on-board and on-ground delays as described previously |

In addition to this once a valid calibrated timestamp has been calculated for a packet downlinked on VC0 a further plausibility check is carried out. This consists of checking that;

1. The calculated timestamp is no more than a configurable number of (usually 2) seconds ahead of the calculated UTC (i.e. ERT minus propagation and ground and spacecraft processing delays) of the transfer frame in which it was downlinked.
2. The calculated timestamp is no more than a configurable number of (usually 15) seconds behind the calculated UTC (i.e. ERT minus propagation and ground and spacecraft processing delays) of the transfer frame in which it was downlinked.

If either of these checks fail, and autocorrection is enabled the time quality flag of the packet is set to Bad and the timestamp set to the calculated UTC of the VC0 frame in which it was downlinked. If autocorrection is disabled no action is taken and the time quality and timestamp remain as before the check was carried out, but a warning message is logged on the control system.

The plausibility checks for VC1 packets consist of checking that;

1. The calculated timestamp is no more than a configurable number of (usually 2) seconds ahead of the calculated UTC (i.e. ERT minus propagation and ground and spacecraft processing delays) of the transfer frame in which it was downlinked.

If this checks fail, and autocorrection is enabled the time quality flag of the packet is set to Bad and the timestamp set to the calculated UTC of the VC1 frame in which it was downlinked. If autocorrection is disabled no action is taken and the time quality and timestamp remain as before the check was carried out, but a warning message is logged on the control system.

18.1.2.2 Telemetry Constants Packet

The Telemetry Constants Packet contains telemetry parameters defined via the TM Spacon process. The generation of these packets is under operator control - a new packet being generated on request. The structure and identification of this packet is defined within the source database.

18.2 Lander Telecommand Verification File (LTVF)

18.2.1 Introduction

The purpose of this section is to define the format for Lander Verification Files (LTVF) created by the Rosetta /Mars Express Mission Control System (RMCS/MEMCS), and for delivery to users via the DDID.

The LTVF files are human readable text files of command bit patterns constructed by command stacks that have been assembled by an RMCS/MEMCS command source.

The LTVF includes a bit pattern of a Lander Operations Request. It is going to be created manually on request only. It is not foreseen to be created during the Comet Phase.^{DCR 206}

18.2.2 Interface Definition

18.2.2.1 General Description

The purpose of the LTVF is to display the bit pattern of commands on a manual command stack.

18.2.2.2 Assumptions and Constraints

The following assumption apply:

- The manual stack will not have the ability to read these file.
- When the file is created by the manual stack, all commands – not only Lander commands – are saved.
- No conflict checking has been done if the stack user provides a SSC for a particular TC that results in non-incremental values being assigned. E.g. if a command at position 10 on the stack is given a SSC of 100, then the command at position 20 is given a SSC of 50 (both of the same APID). In this case, it will be possible for multiple commands to have the same APID/SSC pair

18.2.2.3 Files Location and Naming Convention

The saved location of the LTVF is configuration by use of the MISCconfig variable CMD_BIT_PATTERN_STACK_DIR.

The name of the file is inserted by the manual stack user, and the extension will be the name of the machine that generates the file.

18.2.2.4 Structure of the LTVF Files

LTVF files are ASCII files containing the hex bit patterns of commands on the manual stack. Each entry contains the following information:

- The position of the command on the stack – specified by its row number
- The mnemonic of the command.
- The description of the command.
- The command's source sequence count.
- The PUS version of the command.
- The packet error control checksum
- The packet header.
- The packet data field.

Note: It is possible for the user to specify the SSC and PUS version of the encoded commands.

18.2.3 LTVF File Example

The following table is an example of a LTVF file with 18 commands:

18.3.1 Introduction

18.3.1.1 Purpose

The purpose of this section is to define the standard format and protocol for Detailed Agenda Files (DAF) imported by the DAF Import interface of the Rosetta/Mars Express/Venus Express^{DCR325} Mission Control System (RMCS/MEMCS/VMCS^{DCR325}), and for delivery to users via the DDID.

The DAF file format supports the importing of telecommands by the Rosetta command sources i.e. Pass, MTL and manual command stack applications. Although DAF files are a text format, they are normally constructed by a software application and are not 'hand crafted' using text editors. Typically, DAF files are constructed by the RMCS/MEMCS/VMCS^{DCR325} 'Mission Planning and Scheduling' applications. Additionally, the DAF file format supports the saving of command stacks that have been assembled by an RMCS/MEMCS/VMCS^{DCR325} command source.

Mission Timeline DAFs are available to external users via the DDID.

18.3.1.2 Scope

This document provides a complete definition of the DAF

- As an internal interface, its primary purpose, represents enhancements to the SCOS-2000 Stack Import Interface, defined in the SCOS-2000 Stack Import Interface Control Document [S2K-SI-ICD] and is specific to the RMCS/MEMCS/VMCS^{DCR325}
- As an external interface, MTL DAFs are available externally via the DDS. This provides a feedback mechanism for traceability for external requests.

The DAF Import interface makes no provisions for injecting command execution requests on-line, for submitting command sequences or to load/update sequences execution requests by specifying the sequence parameter values only.

18.3.1.3 References

RD Reference	Document Title/Reference Number	Issue/Rev
S2K-SI-ICD	SCOS-2000 Stack Import Interface Control Document S2K-MCS-ICD-0002-TOS-GCI	Issue 1 99/11/02
S2K-DI-ICD	SCOS-2000 Database Import ICD S2K-MCS-ICD-0001-TOS-GCI	Issue 4.2
S2K-GLOS	SCOS-2000 Glossary, Definitions and Acronyms S2K-MCS-GLO-0001-TOS-GCI	Issue 1.0
PUS	Packet Utilisation Standard ESA PSS-07-101	Issue 1, May 1994

18.3.2 Interface Definition

18.3.2.1 General Description

18.3.2.1.1 DAF file types

A DAF file may be defined as destined for Pass Stack or Mission Time Line (MTL) Stack applications with the following differences:

- Pass DAF files may be loaded only by Pass Stack and Manual Stack applications. The files specify the pass during which the detailed commands are to be executed. The files may detail commands having either 'absolute' release times or 'ASAP' release times but not a mixture. They may only be of category a), as described in Section 2.1.2. They may also detail delete requests for commands already loaded onto the command stack.
- MTL DAF files may be loaded only by MTL and Manual Stack applications. The files may detail Service 11 commands, either execution time-tagged or delete requests for commands already loaded onto the command stack or held in the on-board queue. They may be of any category, as described in Section 2.1.2.

Remark: Other Stack files, formatted in accordance with the SCOS-2000 Stack Import Interface Control Document [S2K-SI-ICD], may be loaded only by Manual Stack applications. They may be of any category, as described in Section 2.1.2.

18.3.2.1.2 DAF file Categories

A DAF file may be categorized by its' combination of release and execution times, as follows:

- a) Having **absolute release times**. Commands detailed in DAF files of this category are all associated to an absolute release time-tag and may or may not associated to an absolute execution time-tag. When importing these files, commands having expired absolute release times are converted to an ASAP release condition.
- b) Having **absolute execution times**, release condition always ASAP. Commands contained in DAF files of this category are all associated to an absolute execution time-tag.
- c) Having **delta release times**, relative to a single absolute time. Commands contained in DAF files of this category are all associated to a relative release time-tag and may or may not associated to an absolute execution time-tag. The reference time to calculate the actual release times will be the dispatch time of the first command in the stack.
- d) Having a **mixture of absolute and delta release times**.

18.3.2.2 Assumptions and Constraints

The definitions of commands, detailed by DAF files, must be available to the importing command source application, by means of the previously loaded Real Time Database (RTDB). The DAF import process does not perform detailed consistency checking between command definitions in the RTDB and the command details in the DAF files. To ensure successful importing, the RTDB must be generated from the same version of the Mission Database (RSDB) as that used in the construction the DAF files. An RMCS/MEMCS command source will issue a warning if the RSDB version identifier does not match.

To be imported correctly, DAF files must conform to the format defined in the sections below. Warnings are issued if an attempt is made to import a DAF file that does not conform.

This ICD does not impose any specific constraint in the methods used to generate, import or maintain the DAF files.

18.3.2.3 Files Location and Naming Convention

A distinction is made between DAFs generated in different circumstances.

- Final DAF, generated by SCH or MPS for use by the MCS, are subject to the specific 'FTS' filename convention detailed below. These files are stored in the DAS, available via DDS and also stored in the server directory are available for use to all clients.
- Draft DAFs, generated by SCH, are stored in a separate server directory and have no specific naming convention.
- DAF files generated by RMCS/MEMCS command sources are created both on the local directory (only accessible by the command sources open on the same workstation) and on the server directory (so that they can be loaded by any source connected to the same server). The user is prompted for the name of these files.

The file naming convention applicable to Final DAFs is as follows.

```
ffff_sordes_txxxxxxxxxxxxxxxxx_vvvvv.ROS
```

where:

`ffff` is the file type identifier, permitted values are :

MDAF	Mission Timeline Detailed Agenda File
PDAF	Pass Detailed Agenda File

`sor` is the source mnemonic, i.e. the mnemonic identifying the node on which the file originates. The permitted source mnemonics are:

SCH	Rosetta Scheduler
-----	-------------------

`des` is the destination mnemonic, i.e. the mnemonic identifying the node to which the file is being sent (ultimately). In the context of this ICD, only one destination is foreseen, viz:

RMA	RMCS prime
-----	------------

`t` is the data type identifier. In the context of this ICD, only one data type is foreseen, viz:

`D` indicates that the file contains data.

`xxxxxxxxxxxxxxxx` is a file specific field and will be ignored. It must however be present, and must be exactly 14 characters in length. In the context of this ICD, only one value is foreseen, viz:

`__YYMMDDhhmmss` indicates the time at which the DAF was created.

vvvvv is the file version number which starts at 00001 and increments for each
ffff_sordes (with wraparound at 99999).

18.3.2.4 Structure of the DAF Files

DAF files are ASCII files containing details required for the construction and assembly of commands on the stack of the importing command source. The details are described by a series of records, delimited by a **new-line** character, each record consisting of alphanumeric or numeric fields delimited by a bar character '|'. The first record in the file is a **base header record** defining:

- The category of the stack file (see Section 2.1 2)
- The source (i.e. an identifier of the application which generated it)
- The name of the database version used to generate it
- The start time of the file (where applicable)
- For PASS DAF files, the Pass during which the detailed commands are to be executed

After the base header record, there are specific command elements specified in the appropriate order. The first record of each command element is a **command header record** defining:

- The command type
- The command identifier
- The dispatch condition
- The release time type
- The release time
- The group condition
- The block condition
- The interlock condition
- The verification stage identifier
- The static pre-transmission-verification (PTV) state
- The dynamic PTV state
- The number of following command parameters
- The execution time tagging condition
- The planning state
- The execution time
- The parent sequence and parent sequence start time
- The on-board subsystem for which the command is destined

- The source of the planned command
- The earliest and latest allowable release times
- The insert/delete state
- The external id

For each of the command elements, zero or more **command parameter records** follow the command header record, defining:

- The name of the editable parameter
- The position of an associated formal parameter in the parent sequence
- The type
- The editable condition
- The representation
- The value
- The dynamic overriding condition

There are command parameter records for each editable command parameter (field CDF_ELTYPE='E'), inserted in the order that they appear in the command's application data field i.e. ordered based on their bit offset as specified in the CDF (field CDF_BIT). After loading the DAF file onto a command source, it is possible to modify the values of editable command parameters (EDITABLE field set to '2') using the standard command source editing facilities.

Command parameters that are defined as editable in their stand-alone database definition (see [S2K-DI-ICD], field CDF_ELTYPE='E'), but fixed when used as part of a sequence command (see [S2K-DI-ICD], field SDF_FTYPE='F'), must also be included in the stack import file with their EDITABLE field set to '1'.

After the records defining a command element (command header record plus command parameter records, if any) either another element header record is expected or the **end-of-file** marker.

A command record intended for deletion, i.e. having the insert/delete state set to 'D', must not have any associated parameter records (and the PARS command header field must be set to 0).^{DCR332}

Remark: DAF files are not formatted specifically for human readability, but for import speed. It is the potential size and nature of the contents of the import file that leads many of the individual field values described in the tables below to take on unintuitive values.

18.3.3 Record Definitions

18.3.3.1 Conventions

There are established conventions that apply to the record definitions in this section:

- Records are completed with the new-line character.

- Fields within a record are delimited by a bar '|' character.
- Fields defined as optional may be implemented as a 'null' field with zero characters, but the bar field delimiter is required.
- Field lengths are considered the maximum number of characters for that field, fewer characters may be used.
- Italicized text indicates that the underlying SCOS-2000 code base does not support the option/field, but that it is under consideration for future implementation.
- Absolute time values, counted in seconds (and 'micro-seconds', optionally), refer to an absolute epoch of 1st January 1970, 00.00.00.
- If database items are referred to, reference is made to the naming convention of each field as defined in [S2K-DI-ICD].
- Command parameter's values are defined in the format corresponding to the parameter type (see Section 4).

18.3.3.2 Base Header Record

Fi. Nr	Field name	Field Type	Description
1	CATEGORY	number(1)	Category type: 0 – All command/sequence records associated to an absolute release time (chronologically ordered). Each command may or may not be associated to an absolute execution time-tag. 1 – All command/sequence records associated to an absolute execution time (chronologically ordered) 2 – All command/sequence records associated to a delta release time 3 – Others.
2	SOURCE	char(8)	Alphanumeric identifier of the source (e.g. OBSM, MPS, MANS, AUTOS, PASS, MTL). This is set to 'PASS' for PASS DAF files and 'MTL' for MTL DAF files.
3	GEN TIME	number(10)	Generation time of file (seconds).
4	RELTYPE	number(1)	<i>0 – Relative release times are to be maintained (i.e. the delta release time is used as a minimum delta release time between subsequent commands). This option is only applicable to files of category 2.</i> <i>1 – Absolute release times as calculated at dispatch time are used as release condition. This option is currently not supported by the underlying SCOS-2000 code base, for files of category 2.</i>
5	VERSION	char(8)	Name of the database version used when file was created. This is used by command sources to ensure that the same database version is used when loading the file.
6	START TIME	number(10)	Release or Execution-time tag of the first command – only relevant if file category 0 or 1 (seconds).
7	PASS ID	char(8)	The unique identifier for the pass during which the commands are to be executed (mandatory for PASS DAF files and optional for other types)

18.3.3.3 Command Header Record

Fi. Nr	Field name	Field Type	Description
1	CMDTYPE	char(1)	Flag indicating that this element is of type command or an on-board control directive as follows (see [S2K-DI-ICD], field CCF_CTYPE). 'C' - If this is a standard command. 'R' - If this is the Reset Map Command (i.e. the Control Segment). 'F' - If this is a Control Frame (i.e. Unlock or Set V(r)).
2	ID	char(8)	Name of the command as given in the CCF (field CCF_CNAME).
3	MAN DISPATCH	number(1)	Dispatch condition 0 – If no manual dispatch 1 – If manual dispatch required..
4	RELEASE	number(1)	Type of release time. 0 – If release time is absolute 1 – If release time is relative to previous entry
5	RELTIME	number(10)	Release time (seconds).
6	GROUP	number(1)	Command grouping condition 0 – If not grouped 1 - If start of a group 2 - If middle of a group 3 - If end of a group.
7	BLOCK	number(1)	Command blocking condition 0 – If not blocked 1 - If start of a block 2 - If middle of a block 3 - If end of a block. Note that the actual implementation of the command blocking into data units (e.g. packets, frames) is mission specific.
8	INTERLOCK	number(1)	Interlock scope 0 – No interlock 1 – Local interlock 2 – Global interlock 3 – Subsystem Local interlock 4 – <i>Subsystem Global interlock (future extension)</i> .
9	ILSTAGE	char(4)	Verification stage ID as specified in the CVP (field CVP_CVSID) or '-1' - for station Reception – first uplink verification stage '-2' - for Uplink/radiation – second uplink verification stage '-3' - for On-board acceptance/transfer – last uplink verification

			stage. Field to be left empty if no interlock (only allowed if 0 specified in INTERLOCK above).
10	STATIC PTV	number(1)	State of static PTV check 0 – Enabled 2 – Overridden.
11	DYNAMIC PTV	number(1)	State of dynamic PTV check 0 – Enabled 2 – Overridden.
12	CEV	number(1)	State of CEV check 0 – Enabled 1 – Disabled.
13	PARS	number(4)	Number of following command parameter records belonging to this command. Commands containing parameters of type 'group repeater' (CDF_GRPsize>0), this field does not necessarily match the number of editable command parameters specified in the database for this command (number of CDF records with CDF_ELTYPE='E') but rather to the total number of command parameters in the expanded command. Must be 0 for deletions, i.e. commands with insert/delete state = 'D'. ^{DCR332}
14	TIME TAGGED	number(1)	Identifying whether this command is time tagged 0 – Not time tagged 1 – Time tagged.
15	PLANNED	number(1)	Identifying whether this command was requested as stand-alone in a planning file or not. 0 – If command is not planned (i.e. derived from expansion of a sequence) and therefore not displayed in summary mode 1 – If command is planned therefore displayed in summary mode.
16	EXEC TIME	number(10)	Execution time if time tagged (seconds).
17	EXEC TIME2	number(10)	Execution time if time tagged (microseconds).
18	PARENT	char(8)	Name of the parent sequence (optional) – matching with the ID of the relevant sequence header record.
19	STARTTIME	number(10)	Start time of parent sequence – used (along with PARENT) to uniquely identify the actual instance of the parent (optional).
20	SUBSYSTEM	number(3)	Identifier of the on-board sub-system to which this command is associated for display, filtering and interlock purposes (optional).
21	SOURCE	number(1)	The source of the command execution request if it is planned, otherwise same source as parent sequence (optional) 0 – Flight Dynamics 1 – SOC.
23	EARLIEST	number(10)	<i>Earliest allowable release time in seconds (optional) (future extension).</i>

24	LATEST	number(10)	Latest allowable release time in seconds (optional) (future extension).
25	TC REQUEST ID	number(4)	External Sequence Request ID. Note that the specified value will be used as TC REQUEST ID of all the commands oin that sequence. ^{DCR314}
26 DCR314	INS/DEL	char(1)	Indicates if the command is to be inserted onto the stack or is an instruction to delete the command identified by the field EXT ID: 'I' indicates a command to be inserted and 'D' indicates a command to be deleted. For command records generated by a Manual Stack, the command record will always indicate 'I' for insertion.
27 DCR314	EXT ID	char(10)	An identifier provided by planning/scheduling systems, unique for each command in the mission. Specified in the following format. xyyyzzzzz <ul style="list-style-type: none"> x indicates the application used to generate the DAF: 'S' for Scheduler, 'P' for Mission Planning, 'M' for Manual Stack and 'O' for OBSM. yyyy indicates the planning cycle number (for DAFs generated by the Scheduler) zzzzz unique identity number. Because this field is only required for deleting commands, it is optional, where the INS/DEL field is set to 'I' for insertion. However it is always specified by the Scheduler.

Note that the TC REQUEST ID is applicable to S2K 3.1 based systems. This means it is immediately applicable to VEX, but only applicable to ROS and MEX once they have been upgraded to a S2K 3.1 based MCS.

For systems where the TC REQUEST ID is not applicable, the following two fields are moved upwards and are thus renumbered from 26 to 25 and 27 to 26 respectively.^{DCR314}

18.3.3.4 Command Parameter Record

Note: commands with insert/delete state = 'D', must not have any associated parameter records.^{DCR332}

Fi. Nr	Field name	Field Type	Description
1	ID	char(8)	Name of the command editable parameter as given in the CDF (field CDF_PNAME).
2	FORMPOS	Number(3)	Position of the associated formal parameter in the parameter list of the parent sequence (only applicable if this command is part of a sequence and if this parameter is associated to a formal parameter of the parent sequence). If this command parameter is not associated to any formal parameter of the parent sequence, then this field must be set to 0.
3	TYPE	Number(2)	Type of parameter used to interpret its VALUE 0 - Unsigned Integer 1 - Signed Integer 2 - Single Precision Real 3 - Double Precision Real (48 bits)

			<p>4 - Double Precision Real ^{DCR 263}</p> <p>5 - Character String</p> <p>6 - Octet String</p> <p>7 - CDS formatted absolute Time</p> <p>8 - CUC formatted absolute Time</p> <p>9 - Delta (Relative) Time</p> <p>10 - <i>Unsigned 64 bit Integer (future extension)</i></p> <p>11 - <i>Signed 64 bit Integer (future extension)</i></p> <p>12 - <i>Bit string (future extension).</i></p>
4	EDITABLE	Number(1)	<p>Indicating whether this parameter is editable. If not editable it must mean that the parameter was fixed at the level of the sequence that this command belonged to (field SDF_FTYPE='F').</p> <p>1 - Not editable</p> <p>2 - Editable.</p>
5	REPTYPE	Number(1)	<p>Indicating the representation/source of the parameter VALUE.</p> <p>0 – Raw</p> <p>1 – Engineering. This option can only be used for parameters associated to a calibration.</p> <p>2 – <i>Take the parameter default value as specified in the CDF (future extension).</i></p>
6	VALUE	char(variable)	<p>The Value of the parameter specified in the appropriate format depending on the parameter TYPE (see Appendix A). Note that numerical values (even if unsigned integer) have to be expressed in decimal. This field is allowed to be empty only if option 2 is used in REPTYPE (future extension).</p>
7	DYNAMIC	Number(1)	<p>Identifying whether the specified VALUE can be overridden by the dynamic default value extracted from telemetry or not.</p> <p>0 – Overriding of VALUE by TM is allowed</p> <p>1 – Overriding of VALUE by TM is not allowed (the parameter value can still be edited if EDITABLE=2).</p> <p>This field is only applicable for command parameters associated to a dynamic default as specified in the CDF, field CDF_INTER='T'. It may be left null otherwise.</p>

18.3.4 Parameter Value Formats

This table defines the character formats for command parameter values for each value type.

TYPE	Format	Examples	Comment
Unsigned integer	Positive integers only.	15, 28, 999	Only decimal is allowed. Supporting unsigned integer values up to 32 bits.

Signed integer	Positive and negative integers.	127, -1, -127	
Simple precision real	IEEE scientific or fixed point notation.	23.13,-1.2E3, 2.5E38	
Double precision real	IEEE scientific or fixed point notation.	23.13,-1.2E3, 1.6E308	
Character-string	ASCII characters	ANY-STRING	Values of this type can only be specified using a raw representation. They cannot be edited with command sources.
Octet-string	ASCII digits in Hex (two digits per octet with no spacing)	0AAFBB	Values of this type can only be specified using a raw representation. They cannot be edited on manual stacks. Typically, values for octet string parameters are generated by the OBSM (memory load data) or by an external system supplying encoded command data. Variable octet strings are also handled. The actual parameter length is determined by the command source by counting the number of octets in the value (1 byte every two digits) and not by reading the value of 'n' (number of octets) (see Section 23.5.7 of [PUS]). If required by the actual encoding of Variable Octet String parameters, the value of 'n' has to be explicitly included in the value itself (i.e. it is not added command sources).
Absolute time (CDS or CUC formatted)	Number of seconds (optionally followed by the number of microseconds) to be added to the reference epoch 1970.001.00.00.00.000.	956355761 25, 988885421	Values of this type can only be specified using a raw representation. In the case of Variable Character String parameters, the actual parameter length is determined by command sources by counting the number of characters in the value (1 byte every character) and not by reading the value of 'n' (number of characters) (see Section 23.5.8 of [PUS]). If required by the actual encoding of Variable Character String parameters, the value of 'n' has to be explicitly defined and included as a separate parameter or a mission specific modification is required (i.e. it is not added by command sources).
Relative time	Number of seconds optionally followed by the number of microseconds	86405 21, 60	Values of this type can only be specified using a raw representation.

18.3.5 DAF File Example

19. Appendix L: Network Implementation Document

19.1 Introduction

In addition to the ground facilities, which are directly required for the Rosetta mission control, the Rosetta ground segment features a Rosetta Science Operations Centre (RSOC). The RSOC shall support scientific mission planning and instrument command request preparation for submittal to the ESOC Operations Control Centre. For this purpose the RSOC receives inputs from the PIs/Lander.

19.2 Scope

The Rosetta Network Implementation Document specifies the communications requirements, the network implementation (protocol, architecture, addressing, routing, security) and the interfacing with private general-purpose networks and with the public networks to support the services for:

1. The Data Disposition System (DDS); retrieval of raw science, housekeeping and auxiliary data kept at ESOC
2. Command Request (CR): submittal of command request to the Operations Control Centre at ESOC;
3. Assembly Integration and Validation (AIV); access to the test database obtained during the spacecraft integration and test programme.

Furthermore, the document addresses:

1. Pertinent network management services;
2. The related schedule aspects

19.3 Network requirements

The Rosetta Science Network connectivity shall interconnect the different locations as depicted below.

	Name	Location	Experiment / Task (1)	Data type Service		
				DDS	CR	AIV
DDS & CR DATA	RSOC	ESTEC, Noordwijk (NL)	Science Operations	X	X	
	ALICE	Boulder, Colorado (US)		X	R	X
	CONCERT	Verrier le Buisson (F)		X	R	X
	COSIMA	Schwetzingen (D)		X	R	X
	MIDAS	Graz		X	R	X
	MIRO	JPL, Pasadena CA (US)		X	R	X
	OSIRIS	Lindau, Jarz (D)		X	R	X
	ROSINA	Bern (CH)		X	R	X
	RPC	Imperial College London (UK) SwRI, San Anotonio, TX (US) IRF-U Uppasala (S) TUB, Bbraunschweig (D) IRF-K, Kiruna (S) LPCE, Orleans (F)		X	R	X
	RSI	COLOGNE (D)		X	R	X
	GIADA	NAPLES (I)		X	R	X
	VIRTIS	ROME (I)		X	R	X
	LCC	COLOGNE (D)		X	R	X
	SONC	TOULOUSE (F)		X		
	ESOC	DARMSTADT (FRG)	Control Centre	X	X	X
	ESTEC	NOORDWIJK (NL)	Project			X
AIV	Alenia	TORINO (I)	Integration site			X
	ESTEC	NOORDWIJK (NL)	Integration site			X
	Launch site	KOUROU (GUY)	Launch site			X

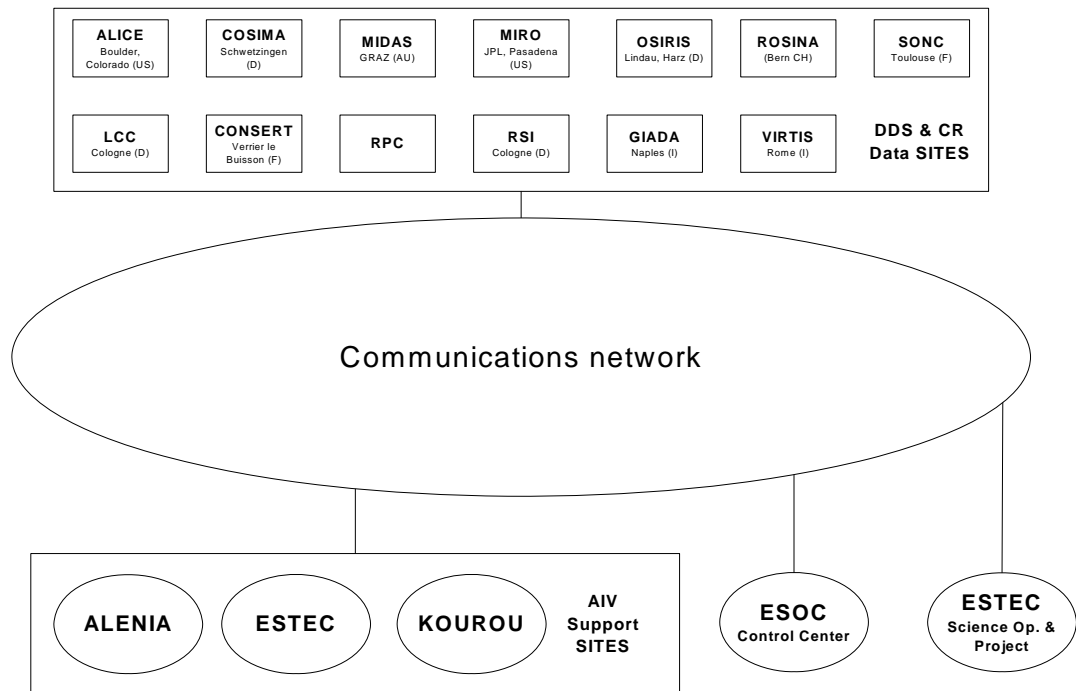

Figure L-1. Communications requirements overall

19.3.1 Services

This section will deal with the Rosetta Science Communications Network transactions in terms of data volumes per day. These volumes depend of course on assumptions of utilization duty cycles of the instruments in-flight, and on the number of days per week on which experiments are carried out. Assumed are 60% duty cycle and transmission on 7 days per week.

19.3.2 Bandwidth requirements

The table below depicts the data to be transferred:¹

NAME	DDS (Mbytes/day)	CR (Mbytes/day) Maximum	AIV (Mbytes/day)	DDS (kbps)	CR (kbps) Maximum	AIV (kbps)
ALICE	20	1	TBC	6	1	TBC
CONCERT	10	1	TBC	3	1	TBC
COSIMA	10	1	TBC	3	1	TBC
MIDAS	10	1	TBC	3	1	TBC
MIRO	20	1	TBC	6	1	TBC
OSIRIS	20	1	TBC	6	1	TBC
ROSINA	10	1	TBC	3	1	TBC
RPC	10	1	TBC	3	1	TBC
RSI	10	1	TBC	3	1	TBC
GIADA	10	1	TBC	3	1	TBC
VIRTIS	20	1	TBC	6	1	TBC
LCC	20	1	TBC	6	1	TBC
SONC	20	1	TBC	6	1	TBC
ESTEC	20	1	TBC	6	1	TBC
RSOC	TBC	5	TBC	TBC	TBC	

- **DDS (Data distribution System).** This service pertains to the retrieval of raw science, housekeeping and auxiliary data by the PIs/Lander from the DDS machine at ESOC.
- **CR (Command Requests).** Command Requests are submitted from the PIs to the RSOC, where they are combined and forwarded to the Operations Control Centre at ESOC.
- **AIV Support (AIV).** During the spacecraft integration and test program, remote access is required to the databases offering the test result data. These databases will be located at Alenia, ESTEC and Kourou. The amount of data cannot be computed in advance as it depends on activities that will only be known at the time of the integration. Therefore and for this data throughput requirements study, it will be considered unknown with the assumption that the Internet bandwidth will be enough.

¹ It is assumed that:

- Data transfers take place on average 8 hours per day on every day of the week
- The communications overhead for the 4 level protocol is 7.5%

19.3.3 Quality of Service/Availability requirements

The network design, implementation and management shall be commensurate with the Quality of Service (QOS) parameters applicable to the various service types as defined in the table below:

Service required	DDS	CR
Availability	Medium	High
Throughput Reserve (for actual transactions)	Medium	Low
Backlog Reserve / Bandwidth Margin (for retransmission)	Medium	High
Operations and maintenance (O&M) Support	Medium	High

The **Command Request service** requires the highest overall QOS, particularly in terms of availability, reserved bandwidth, backlog reserve and O&M support.

The Data Disposition System is very sensitive against backlogs which could be built up during phases of network congestion or downtime, and which could make data "outdated". Special cases are the **LCC** and the **SONC** that require a higher backlog. Special communication mechanisms shall be provided to fulfil this requirement.^{DCR 206}

An analysis of the above listed **QOS** parameters leads to the conclusion that a reliable connecting with high level of availability and sufficient bandwidth must support the command request link between ESOC and RSOC.

19.3.4 Security requirements

Below a table of requirements for the data transfers between all the entities is presented:

Service required	DDS	CR
Authentication	Required	Required
Integrity	Required	Required
Confidentiality	Required	Required
Non repudiation	No required	Required

The IP protocol suite to be used should support the above features. The implementation of such can be done at the pure networking levels (one, two, tree, four) or by means of a specific application that provides the services.

19.3.5 Service management requirements

The Rosetta Science Communications Network may partially rely in some services provided by some national and international network provided. This section clarifies the responsibilities boundaries for the provision and maintenance of the network infrastructure:

Service	Provision	Configuration of the end networking elements	Charges to be paid by

Lines between AIV sites, ESOC and ESTEC	ESA	ESA	ESA
Dial on demand from remote sites	End site	ESA	End site ²
Public Network (The Internet)	End site	End site	End site

19.4 Network Implementation

19.4.1 Rosetta Science Communication Network implementation

The Rosetta Science Communications Network will be based exclusively in the IP protocol suite. High level protocols will be used to exchange data providing the required QOS.

The analysis of the requirements described in the previous chapter including the QOS and the security constraints leads to the conclusion that the network should be based in three different types of network infrastructures: dedicated lines to interconnect the main and more critical sites³, the public Internet to exchange data between these centres and the remote users, and dial on demand lines (ISDN) for those sites having a higher QOS requirements.

Below, a drawing with the proposed network topology is presented.

² Calls will be initiated at the user side

³ Existing network infrastructure will be reused if possible (ESACOM)

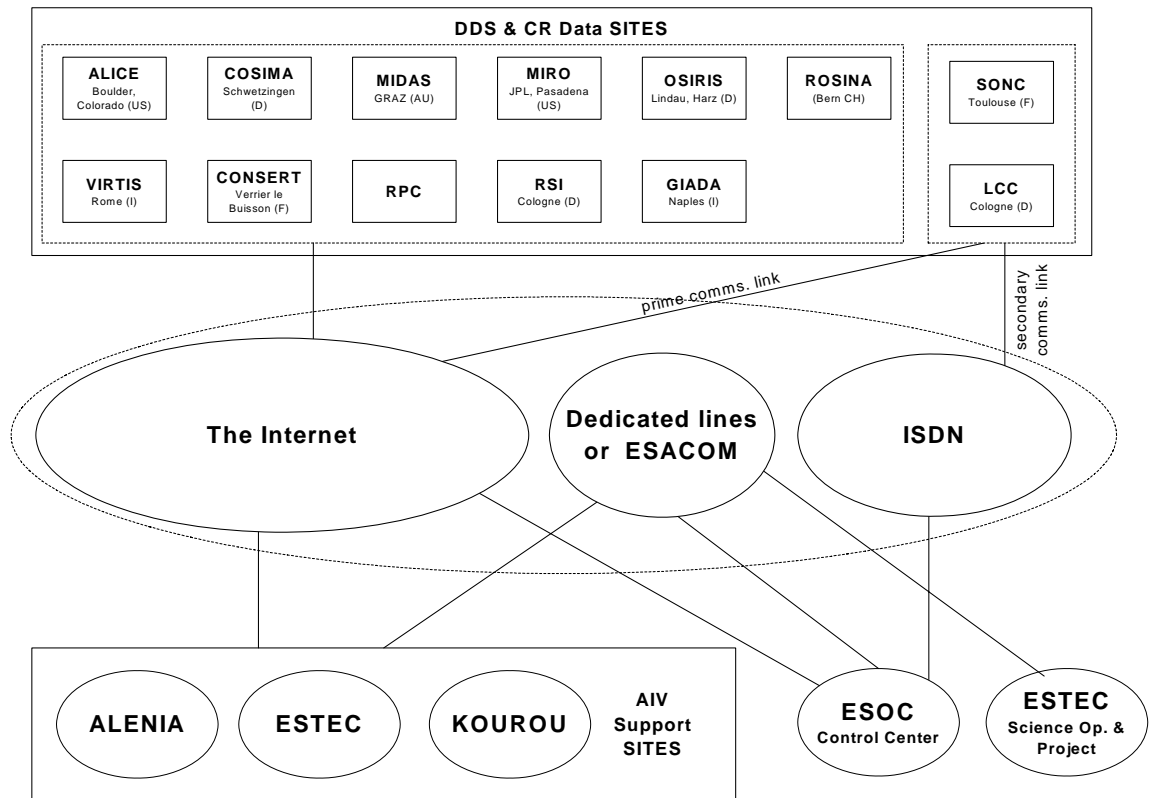

Figure L-2 Rosetta Science Network implementation overview

The table below lists the routing mechanisms to be used:

From	DDS	CR	AIV data
ALICE	Internet to ESOC	Internet to ESOC	Internet to AIV site (*)
CONSERT			
COSIMA			
MIDAS			
MIRO			
OSIRIS			
ROSINA			
RPC			
RSI			
GIADA			
VIRTIS			
LCC	Prime path: Internet to ESOC	Prime path: Internet to ESOC	Internet to AIV site (*)

From	DDS	CR	AIV data
SONC	Secondary path: ISDN to ESOC	Secondary path: ISDN to ESOC	
ESTEC	ESACOM to ESOC	ESACOM to ESOC	ESACOM to ESOC
RSOC			

(*) This implementation assumes that the test result database system at the AIV site is logically fully separated from the operational EGSE interface to ESOC. ESOC reserves the right to audit this logical separation at any time and to stop any database access in the case that a potential risk for the IP OPSNET is observed.

19.4.2 MEX Science Communication Network implementation

TBW^{DCR150}

19.4.3 Security implementation

19.4.3.1 Data security

The network security protocols state of the art is not mature enough to provide a simple mechanism to implement the security requirements. Therefore, the implementation of these requirements shall be done at application level (TBC).

19.4.3.2 ^{DCR129}Access rights control

It is the responsibility of each site to protect their systems against external attacks. The server elements (DDS, CR) will be protected by ESA as they will be located at ESOC.

19.4.3.3 AIV Communications

For AIV activities, PIs will be provided with the ability to connect remotely, throughout the relevant project phases, to EGSE LAN segments at Alenia, ESTEC and the Launch Site.

19.4.4 Addressing and Routing

IP addresses of the Rosetta Science Communications Network will be assigned by the organisation administering the site. It is also the responsibility of the site to set up, manage and keep under configuration control the routing and advertising across the network.

Exceptions are the dedicated ISDN lines to the *LCC* and *SONC* sites. The IP addresses to be used for the WAN link shall be assigned by ESA. The remote site shall provide ESA the IP address of the Ethernet-LAN point of presence of the router to be provided. It is also the responsibility of the remote site to implement and document all the mechanisms required to change the routing of the local systems to go through this router when the secondary path is used.

19.5 Network services agreement

19.5.1 Operations and Maintenance

Operations and maintenance (O&M) of all the **LANs** participating in the Rosetta Science Communications Network shall be the responsibility of the remote site (PI/Lander).

The provision, administration, configuration and management of **the Internet access** shall also be the responsibility of the remote site. This shall include all aspects of administration and configuration management. Liaison to the national ISP for matters pertaining to the ISP PoP and the ISP access link shall also be the responsibility of the remote site.

In the case of LCC and SONC the dial on demand **ISDN lines** to be used as secondary communication path will be provided and administered by the remote site as well as all costs associated. ESA will provide to these remote sites the required network elements to establish the connection to the DDS and CR centres. It will be under ESA responsibility the initial configuration and further management of these networking elements. The calls will be in general initiated at the remote site. No callback mechanisms are foreseen.

With the purpose of an efficient administration of the Rosetta Science Communications network, each PI/Lander shall nominate a **Network System Administrator**, who shall act as the single point interface either locally or within the Rosetta Science Communications network community.

19.5.2 ESA Contacts and Coordination

At ESOC, the point of contact for Rosetta Science **Communications links** with ESOC will be the OPSNET Service Desk. This entity is on duty 24 hours a day every day of the year. They will be in charge of all initial contacts and of 1st line maintenance activities. Should 2nd or 3rd line maintenance become necessary at ESOC, this will be arranged by the OPSNET service desk.

The point of contact for Rosetta Science Communications Network **Host** matters, in particular for DDS, is the Operations Support Centre (OSC).

The OPSNET Service Desk can be reached as follows:

Telephone	+49 6151 902496
FAX	+49 6151 903934
email	shiftc@esa.int

The OSC can be reached as follows:

Telephone	+49 6151 902249
FAX	+49 6151 902070
email	esoc.osc@esa.int ^{DCR 163}

19.5.3 DDS Access and Accounts

Access to the Data Disposition system (DDS) machine at ESOC is only granted to the PIs/Lander and their designated representatives. See appendix C.

Requests for changes to the users list shall be duly authorized by the Rosetta Project Scientist and submitted to the Rosetta SOM at EOC.

19.6 SCHEDULE

The Rosetta Pre-Launch and LEOP scheduled is maintained separately. The below milestones are therefore indicative only.

