

DFMS Instrument Modes and Measurement Sequences:

Table of contents

<i>DFMS Instrument Modes and Measurement Sequences:</i>	<i>1</i>
1 <i>DFMS Instrument Modes and Sequences.</i>	5
2 <i>DFMS Instrument Parameter Settings.</i>	6
3 <i>Explanations to DFMS Parameters</i>	7
4 <i>DFMS Sub-Parameter Definition</i>	11
5 <i>Examples of DFMS modes</i>	15
6 <i>Possible Standard DFMS Modes</i>	17
7 <i>Power Consumption in the different modes</i>	31
8 <i>Mode Transitions</i>	32
8.1 <i>From Standby (S2) to active mode (2 / 3 / 4) and vice versa</i>	32
8.2 <i>From Ion mode to Gas mode and vice versa</i>	32
8.3 <i>Change of detector</i>	32
8.4 <i>From Standby to Ion source heater mode and vice versa</i>	32
8.5 <i>Transition into emergency mode E2</i>	32
8.6 <i>All other mode changes</i>	32
9 <i>Examples of DFMS measurement sequences</i>	34
10 <i>Data compression and telemetry (not yet updated)</i>	36
11 <i>Background spectra</i>	41
12 <i>On board data reduction</i>	42
13 <i>Hidden measurements</i>	43
Appendix A: Detector operation requirements for the DFMS flight software	45
13.1 <i>Reference document</i>	46
13.2 <i>MCP related operations</i>	46
13.2.1 <i>Fundamental operations</i>	46
13.2.2 <i>Safety aspects</i>	47
13.3 <i>LEDA related operations</i>	47
13.3.1 <i>Setting of integration time</i>	47
13.3.2 <i>Starting an accumulation with a given number of accumulations</i>	47
13.3.3 <i>Accumulation memory zones</i>	48
13.3.4 <i>Reading commands</i>	48
13.4 <i>Operations related to the MCP-LEDA combination</i>	48
13.4.1 <i>Temperature test</i>	48

13.4.2	Offset of FDP-A ADC	48
13.4.3	Bad pixel map initialization	48
13.4.4	LEDA background measurement.....	49
13.4.5	DFMS voltage setting	49
13.4.6	MCP HV automatic gain control	49
13.5	MCP/LEDA – CEM - FC intercalibration:	50
13.6	MCP/LEDA gain calibration scan:	50
13.7	MCP burn out protection:.....	50
13.8	RDP heater operation:.....	51
14	<i>Appendix B: SEL Table</i>	52
15	<i>Appendix C: LEDA Offset Algorithm</i>	53
16	<i>Appendix D: Gain adjustment algorithm for LEDA</i>	54
17	<i>Appendix E: Gain adjustment algorithm for CEM</i>	56
18	<i>Appendix F: Sensitivity selection for Faraday.....</i>	57
19	<i>Appendix G: Table values for DFMS detector adjustments.....</i>	58
20	<i>Appendix F: CEM stepping</i>	59
21	<i>Appendix G: Cover operation</i>	60
22	<i>Appendix H: Some useful relations.....</i>	61
22.1	Mass dispersion on MCP „low resolution“.....	61
22.2	Gain Steps	61
22.3	Vaccel as a function of mass.....	62
22.4	Mass as a function of Vaccel	62
22.5	Get a feeling for the partial pressure of a species	63
23	<i>Appendix I: Data Analysis Procedure (taken from RD3).....</i>	65
23.1	Computing the Ion Current	66
23.2	Computing the Gain.....	70

Change Record

Issue	Date	Change	Responsible
1.0	March 2000	Initial Issue	Eberhardt
2.0	June 2000		Eberhardt
3.0	November 2000	Consolidate parameters, ion modes	Altwegg
3.1	December 2000	Background modes, cover	Altwegg
3.2	December 20, 2000	Power figures, mode transitions	Altwegg
3.3	March, 15 2001	Calibration modes	Altwegg
3.4	October, 25 2004	Gain adjust, CEM scan	Altwegg
4.0	February, 2005	Some useful relations, consolidation	Altwegg
4.1	April, 2005	New mass tables (mass 12 problem)	Altwegg
4.2	April, 2010	Add Mode 1100 definition	Semon

Reference Documents

Reference Nr.	
RD1	ROSINA User Manual
RD2	Detector operation requirements for the DFMS flight software Original by: Jean-Jacques BERTHELIER, CETP
RD3	DFMS-FS Calibration report static mode v1.0.doc, U. Langer, Jan 2003

1 DFMS Instrument Modes and Sequences.

Most voltages etc. in the DFMS are fully programmable. A very large number of instrument configurations adapted to specific scientific problems are thus possible. However, to specify an instrument configuration by defining each voltage individually would be extremely cumbersome. Furthermore, each configuration would have to be calibrated individually, which is not feasible. It is thus mandatory to limit the number of different instrument configurations used and to define a limited set of high level parameters for characterizing the configuration and the measurement to be made:

Instrument Mode: Instrument configuration used for specific measurement defined by setting of parameters.

Measurement Sequence: A fixed set of modes to be performed sequentially. Sequence may be repeated several times or indefinitely.

With such an approach it is possible to predefine the measurements of the instrument for a lengthy time period based on the scientific goal to be achieved without requiring a detailed knowledge of the command structure and low level command definition of the instrument. It will be the task of the DPU to translate these high level commands into voltage etc. settings for the instrument. The DPU must also make the necessary checks, that instrument safety is not compromised (i.e. filament and high voltage switch on procedures must be automatically met etc.).

2 DFMS Instrument Parameter Settings.

Parameter	Settings	Remarks
Function	GAS IONs{U1,U2,U3,U4} OFF	
Task	COMetary NOlse OPTimization{gcu} CALibration{gcu}	
Cover Emission	COV{pos1,pos2} OFF{fil} SUBemission{fil}	fil>9: outgassing for fil seconds Not applicable for Function. Neutral
	LOW{fil}	p < 10-6 mbar required
	MEDium{fil}	p < 10-7 mbar required
	HIGHh{fil}	p < 10-8 mbar required
Electr. Energy	HIGH LOW VARIABLE{U1,U2}	70 eV 17 eV, tbc Appearance Potential Meas.
Resolution	LOW HIGH	
Zoom	ZOOM{zoom}	
Detector	MCP{integration,accumulations,configuration,gain} CEM{integration,gain} FARaday{sens}	
Masses	CONTiguous Range Integer{Min,Max,Mref} ALL Integers in Range{Min,Max,Mref} SElected {entry} SCAN{Min,Max,Mref}	
Compression	TElemetry{accuracy,add,dog}	

Italics: Sub-parameters to be entered with parameter setting.

The three capital letters represent the mnemonic designation of the parameter settings.

3 Explanations to DFMS Parameters

A set of parameters determines the exact operation mode of the DFMS. The parameters must be interpreted by the DPU and translated into lower level commands to the electronics. This interpretation must also take into account the previous history and modes of the DFMS as well as an array of status flags etc.

Not every parameter combination may be reasonable or allowed. The DPU must check this.

In certain modes it might be necessary, that the instrument makes certain "hidden" measurements to provide technical information to the DPU for the performance of the mode. As an example, it might be necessary for a high resolution measurement to first establish an exact mass scale by measuring one or several dominant peaks.

Function: This parameter makes the basic decision if the instrument should be used to measure gas (neutral mode) or preexisting (cometary) ions. The parameters of the ION mode are related to the attraction grid potential and the ISP. The first two sub-parameters U1,U2 determine the potential of the MG, the second set U3,U4 the ISP and screening grid. If U1=U2 then the voltage is fixed. If U1 not U2 then the voltage is scanned in a fixed number of steps (limits included). The same holds for U3, U4. OFF is the off procedure for DFMS.

Task: This parameter selects the task of the DFMS. COMetary means, that the instrument measures either the cometary gas or ions. Equally important is the task NOise. It means that ions are blocked off in the transfer optics in order to measure electronic noise of the detectors. In the task OPTimization all DFMS voltages etc. must be optimized. This can be done with cometary gas {gcu=0} or with gas from the GCU {gcu=1(low pressure), 2 (medium pressure), 3(high pressure)}. This will require elaborate algorithms, which must be thoroughly tested. The task CALibration will be used to recalibrate the DFMS with the GCU (gas calibration unit) in regular intervals. The parameter gcu has the same meaning as above.

Cover: This parameters selects the cover position. Pos1=pos2 means a fixed position (0=open, 1=closed); if pos1 and pos2 are different the cover will open or close from pos1 to pos2 with a stepwidth (open-closed)/10; **TBC** allowing measurements at each intermediate position including the end values. This can be used to get a feeling for the background (internal gas, reflected particles from S/C) or to block off gas from entering through the wide field of view when using the narrow field of view. However, the cover has a limited lifetime (number of operations), which should not exceed 2000. Therefore background spectra should not be taken more than about once a day.

Emission: This parameter selects the electron current used in the ion source to ionize the gas. It also selects which filament is operative. Normally the default filament should be used and the second one be kept as spare. The number of emission settings should be kept as low as possible, 3 settings of 2, 20 and 200 microA are implemented. The HIGH setting should be used sparingly. In the setting SUBemission the filament is kept hot, but at a temperature were emission is negligible (filament current must be lowered by a predetermined fraction from the emission value and the filament current must be kept

constant). Furthermore, it may be necessary to change some potentials, to prevent electrons from leaving the filament. The setting of the emission depends on several external parameters (i.e. pressure as measured by COPS and as determined from most recent suitable DFMS and RTOF gas mass spectra) as well as filament "history".

The sub-parameter in the parameter emission could be used for commanding the **ion source outgassing** with the internal heater. If in OFF(fil) fil >9 then the instrument would switch into the outgassing mode for a time of fil seconds. All other parameter settings would be disregarded.

Electron Energy: The electron energy in the source can be adjusted continuously. However, to simplify calibration etc. it is advisable to use only two values: a **HIGH** value which gives optimal sensitivity of the source (70 eV, tbc), and a **LOW** value (17 eV, tbc), which gives lower sensitivity but much less fragmentation of the molecules. Such spectra can be used to help in the identification of the molecules (and radicals) in the cometary gas. The **LOW** setting might possibly not be used together with **HIGH** emission (combination must be excluded by DFMS OS). In the **VARIABLE** setting the electron energy will be stepped (0.2eV steps, tbc) from U1 to U2 (U1 > U2 must hold). If U1 = U2 only one spectrum will be recorded with the electron energy = U1. Again, the DPU must prevent dangerous combinations of electron energy and emission, that is the filament current must be clamped. The **VARIABLE** setting is useful to measure appearance potentials for aiding in the identification of molecules and radicals.

Resolution: This parameter is straightforward.

Zoom: The sub-parameter "zoom" specifies the amount of magnification required. **LOW** resolution data will normally be recorded with zoom =1. For **HIGH** resolution the zoom is set to 6.2 (was 6.2 before 1/2005)

Detector: The standard detector will be the MCP-LEDA.

The parameter **MCP**(integration, accumulations, DIA, configuration, gain) specifies with the sub-parameters the detailed operation of the LEDA etc. The sub-parameter **integration** specifies the integration time (in units of basic read-out cycles of 6.5 msec), it determines the time between read-outs of the LEDA (that is how long the MCP current is integrated on the individual anodes of the LEDA). The sub-parameter **accumulations** specifies the number of readouts taken and added.

The clock of the housekeeping readout disturbs the LEDA accumulations. Therefore the integration time times no. of accumulations cannot exceed the time between HK readouts which is 2 s in normal measurement modes and 200 ms during GCU modes.

Since 1/2005 this limitation can be overcome by internal accumulation of spectra in the DPU **DIA**. Currently all modes are set to a complete integration time of 19.5 s.

Longer integration time with DPU internal accumulation for all MCP modes:

- Normal: 10 DPU Accu * 30 FDP Accu * 10 Integrations * 6.6 ms = 19.5 s
- GCU (Modes:100, 102, 150, 152): 100 DPU Accu * 3 FDP Accu * 10 Integrations * 6.6 ms = 19.5 s
- Inverted (Modes:232, 233, 237, 238, 242, 243, 252, 253, 1002, 1003, 1005): 10 DPU Accu * 6 FDP Accu * 50 Integrations * 6.6 ms = 19.5 s

- Mode 1912: 100 DPU Accu * 10 FDP Accu * 30 Integrations * 6.6 ms = 19.5 s

The sub-parameter configuration specifies if post-acceleration is off or on and if the potential between MCP and LEDA is normal or inversed (improved spatial resolution). The subparameter gain specifies if the spectrum are recorded in a GS modus only or if also a HG modus is used to facilitate the measurement of small peaks. In the GS mode the DPU adjusts the MCP gain automatically in steps until the largest peak is between about 30 % and 90 % of full scale (exact limits depend on detector performance etc and slightly different values may have to be used). Gain steps changing the MCP gain by about a factor of 3 are used (finer steps would make the calibration work very large). Some hysteresis is included in the GS algorithm to prevent hunting.

The sub-parameter configuration is also used to define an alternate definition scheme of the gain sub-parameter. In this alternate scheme the value of gain defines the gain step to be used. This clamping of the gain step will only be used in certain modes, for instance for determining the MCP noise. This noise depends on the GS used. The DPU will check, that no overloaded pixels occur at the set gain step and if necessary reduce the GS. Details see chapter 8.

The setting CEM(integration, gain) selects the channeltron as detector. The sub-parameter integration specifies the integration time in the counting and analogue modes. The sub-parameter gain may be necessary to specify the gain adjustment philosophy in the analogue mode.

The setting FARaday selects the Faraday detector as detector. The parameter *sens* gives the sensitivity range (0=auto, 1=low, 2=medium, 3=high)

Masses: This parameter specifies the mass range covered by the specific mode and the mass settings used for doing this. The different parameter setting will work in different ways depending on the resolution and the detector used.

In the setting CONTiguous Range Integer(Min,Max,Mref) all integer masses from mass Min to mass Max (including Min and Max) are sequentially measured. The reference mass Mref is measured before and after the sequence from Min to Max is measured. It serves as reference to check for instrument instabilities or changes in cometary gas or ion density during the time required to make the measurement from masses Min to Max. The detail how this measurement is made depends on the settings for the parameters **Resolution** and **Detector**:

LOW, MCP: Several masses can be measured simultaneously (range about 10 % of center mass). The center masses are selected to provide coverage of all masses from Min to Max, measuring each integer mass only once. Thus to cover for instance the range from 40 to 80 about 8 settings are required.

HIG, MCP: Only the center of the MCP is useful for high resolution work. Thus all masses Mref, Min, Min+1, ..., Max, Mref must be focused on the center of the MCP and measured

individually. To cover for instance the range from 40 to 80 a total of 41 settings are required.

LOW, CEM: Each mass to be measured (Mref, Min, Min+1,...,Max, Mref) must be focused on the CEM and a mini-massscan from M-dM to M+dM in steps ddM must be made.

HIG, CEM: Each mass to be measured (Mref, Min, Min+1,...,Max, Mref) must be focused on the CEM and a mini-massscan from M-dM to M+dM in steps ddM must be made. It is assumed that (mass dependent) default dM and ddM values can be used. The dM and ddM values are different from the LOW,CEM case.

LOW, FAR: Each mass to be measured (Mref, Min, Min+1,...,Max, Mref) must be focussed on the Faraday and a mini-massscan from M-dM to M+dM in steps ddM must be made. It is assumed that (mass dependent) default dM and ddM values can be used. The dM and ddM values are different from the LOW,CEM and HIG,CEM cases.

HIG, FAR: The image should be much smaller than the width of the slit in front of the Faraday collector. No miniscan is thus required, each mass Mref, Min, Min+1,..., Max, Mref can be sequentially focused on the center of the Faraday and the total beam current will be measured. For each mass the zeroline must be established, either by suppressing the ion current (can we do that, will it give stability problems) or by making an additional measurement for each mass with the mass line shifted by an amount dM. It is assumed, that (mass dependent) default values can be used. As an alternate approach a continuous mass scan from Min-dM to Max+dM could be used, the advantages and drawbacks of the two approaches must be compared in detail. Not implemented because sensitivity is too small.

In the setting **ALL Integers in Range(Min,Max,Mref)** all integer masses from mass Min to mass Max (including Min and Max) are sequentially measured. For the **Resolution** and **Detector** parameter settings HIG,MCP; LOW,CEM; HIG,CEM; LOW,FAR and HIG;FAR the ALL and CON settings are identical. For the LOW,MCP combination the two are different. In the ALL setting mass Mref, Min, Min+1, ..., Max, Mref are sequentially focused on the same position of the MCP. This should not be the center region of the MCP as this part is extensively used in the HIG resolution setting. An offset of about 3 mm to the left or right of the center will not lead to any performance degradation. In the ALL setting all masses are measured on the same spot of the detector and detector inhomogeneities do not influence the results. Mass ratios and absolute intensities are thus more accurate in the ALL setting than in the CON setting. However, the ALL measurement takes about five times longer than the corresponding CON measurement.

Remark: The offset of the focal point from the center should be established based on the detector performance. A focus on the left and a focus on the right of the center should be predefined and used as default. One side should be selected for use, the other side is then the back-up (to be changed by special command).

In the setting **SElected(entry)** the randomly selected masses in the table SEL, line # entry M1,M2,...,Mn are sequentially measured. The Mi values do not have to be integers. This gives a maximum of flexibility in designing measurement sequences adapted to a specific problem. The detail how this measurement is made depends on the settings for the parameters **Resolution** and **Detector**:

LOW,MCP: The masses M1,M2,...,Mn are sequentially focussed on the same spot (not the center) of the MCP.

HIG,MCP: The masses M1,M2,...,Mn are sequentially focussed on the center of the MCP.

LOW,CEM; HIG,CEM and **LOW,FAR**: A miniscan as in the CON setting is required for each mass M1,M2,...,Mn.

The setting **SCAN**(Min,Max,Mref) will be used with all the detector settings MCP, CEM and FAR. The mass values Min, Max and Mref are not necessary integers. For the MCP it means a scan of one particular mass line over the MCP to recalibrate the pixel gain. First mass Mref is measured making a mini-mass scan. Then the mass range from Min to Max is continuously scanned over the active detector using mass steps ddM. The mass steps ddM are resolution, detector and possible mass dependent. Then Mref is measured again. The setting SCA can take very long to perform, especially in the resolution-detector combination HIG,CEM. It will only be used for diagnostic purposes to check peak shapes, search for ghost peaks, recalibrate pixel gain etc.

Compression: The sub-parameters of this parameter with the only setting **TEL** define the data compression scheme to be used in transmitting the data to earth. **Accuracy** defines the accuracy (8, 10, or 12 bit) with which the signals in the individual pixels are transmitted. If $acc < 0$ then a wavelet compression scheme is used. Details TBD. It also specifies the treatment of the data from rows A and B of the LEDA. **Add** specifies the number of adjacent pixels to be added. **Dog** specifies to the telemetry watchdog the handling of a data overload (perhaps this sub-parameter is not necessary).

OPEN QUESTION: After the instrument has executed the mode and no immediate command for a new mode follows what will the instrument do. This must be discussed and specified. From a safety point of view the instrument should, after a certain waiting periode, go into a safe mode.

4 DFMS Sub-Parameter Definition

Ions:

DIM U1, U2, U3, U4 single ###.#
 U1 = U2 Fixed attraction grid potential
 U1 < U2 Scan of attraction grid from U1 to U2, in 7 steps 2V (tbc)
 U3 = U4 Fixed ISP
 U3 < U4 Scan of ISP from U3 to U4, in 9 steps (tbc)
 Hierarchy: for U1 to U2 step (U2-U1)/6
 for U3 to U4 step (U4-U3)/8
 make measurement
 next U3
 next U1
 -50 < U1,U2 < +50
 -100 < U3,U4 < + 100

GCU: =0 GCU closed

=1 Low pressure, 1V ~1 e-6 mbar source pressure
 =2 Medium pressure, 1.2 V ~2 e-6 mbar source pressure
 =3 High pressure, 1.4 V ~3.5 e-6 mbar source pressure

Cover: pos1, pos2

Pos1=pos2 fixed position
=0: cover open
=1: cover closed
Pos1≠pos2: steps of 10 degrees from pos1 to pos2

Emission:

DIM fil integer

fil = 0 Default filament

fil = 1 Filament 1

fil = 2 Filament 2

fil = 3 to 9 Not used, error message results

fil > 9 Ion source degassing for fil seconds

fil > 65'535 Not allowed, error message. Limits degassing to about 1 day

low emission: 2 μA

medium emissionb: 20 μA

high emission: 200 μA

Electron Energy: VAR(U1,U2)

DIM U1,U2 single ##.##

U1 = U2 Fixed electron energy

U1 > U2 Scan of electron energy from U1 to U2 in steps of 0.2 V (tbc)

U1 < U2 Not allowed, error message

U1, U2 > 10.0 Energies below 10 Volt (tbc) not allowed as this might endanger the filaments. Error message

Zoom:

DIM zoom byte

zoom = 0 Default zoom appropriate for resolution/detector combination

0 < zoom < 7 Specified zoom value is used. This value was 6.2, and is currently (1/2005) set to 6.2

Detector: MCP(integration,accumulation,DIA, configuration,gain)

DIM integration integer

int = 0 Default value

0 < int < 308 Integration time in units of basic read-out cycles of 6.5 msec

int > 308 Not allowed,

DIM accumulation integer

acc = 0 Default value

0 < acc < 308 Number of accumulations, limits tbc

acc > 308 Not allowed, error message

integration x accumulation <2000 (<200 for GCU modes) due to interference between HK readout and data accumulation)

dsi DPU-internal accumulation, number of above spectra which are integrated in the DPU before transmission of one spectrum to ground, currently set to 10 for normal modes, set to 100 for GCU modes

DIM configuration byte

conf = 0 Default setting used appropriate for setting of other parameters
conf = 1 Postaccel. off, MCP-LEDA normal
conf = 2 Postaccel. off, MCP-LEDA inverted
conf = 3 Postaccel. on, MCP-LEDA normal
conf = 4 Postaccel. on, MCP-LEDA inverted
4 < conf < 8 Not allowed, error message

Postacceleration is switched on for masses >50 amu to -2900 V (1/2005, was -3000 V before)

Add **eight** to configuration value to invoke **alternate** definition of sub-parameter **gain**

conf = 8 Default setting used appropriate for setting of other parameters
conf = 9 Postaccel. off, MCP-LEDA normal, alternate gain definition
conf = 10 Postaccel. off, MCP-LEDA inverted, alternate gain definition
conf = 11 Postaccel. on, MCP-LEDA normal, alternate gain definition
conf = 12 Postaccel. on, MCP-LEDA inverted, alternate gain definition
12 < conf < 16 Not allowed, error message

DIM gain byte

gain = 0 Default, to be defined
gain = 1 Normal gain step procedure: GS
gain = 2 One measurement in GS, one measurement with about 3 fold increased gain (HG1)
gain = 3 One measurement in GS, one measurement with about 9 fold increased gain (HG2)
gain = 4 One measurement in GS, one measurement with about 27 fold increased gain (HG3)
gain > 4 Not allowed, error message

Alternate gain definition (depending on sub-parameter configuration)

-16 < gain < -1 The value of gain sets the gain step to be used. If the DFMS detects an overloaded pixel, the GS is reduced to prevent damage to the MCP

It might be advisable to impose certain limits:

int*read < 10'000 remain only 65 sec on same mass

if gain > 1 then int*read < 1'000 limit MCP overload to less than 6.5 sec, not applicable to alternate gain definition

Detector: CEM(integration,gain)

0<gain<8

See above for definition of gain and integration

Detector: FAR(gain)

Gain: low (1), medium(2) or high(3) electrometer range; 0 default (auto)

Masses: CON(Min,Max,Mref)

DIM Min, Max, Mref integer
Min < Max Scan up in mass
Min > Max Scan down in mass (not used)
11 < Min < 200 limits 140
11 < Max < 200 limits 140
11 < Mref < 200 limits 140

Masses: ALL(Min,Max,Mref)

DIM Min, Max, Mref integer
Min < Max Scan up in mass
Min > Max Scan down in mass (not used)
11 < Min < 200 limits 140
11 < Max < 200 limits 140
11 < Mref < 200 limits 140

Masses: SEL(entry)

Entry: Row number of table containing selected masses appropriate for the scientific question (see Appendix B)

Masses: SCA (Min,MAX,Mref)

DIM Min, Max, Mref integer
Min < Max Scan up in mass
Min > Max Scan down in mass (not used)
11 < Min < 140
11 < Max < 140
11 < Mref < 140

Compression: TEL(accuracy,add,dog)

DIM acc byte
acc = 0 default data compression, rows A & B added
acc = 1 8 bit data compression, rows A & B added
acc = 2 10 bit data compression, rows A & B added
acc = 3 12 bit data compression, rows A & B added
acc = 4 default data compression, rows A & B separate
acc = 5 8 bit data compression, rows A & B separate
acc = 6 10 bit data compression, rows A & B separate
acc = 7 12 bit data compression, rows A & B separate
acc = 8 default data compression, row A only
acc = 9 8 bit data compression, row A only
acc = A 10 bit data compression, row A only
acc = B 12 bit data compression, row A only
acc = C default data compression, row B only

acc = D	8 bit data compression, row B only
acc = E	10 bit data compression, row B only
acc = F	12 bit data compression, row B only
acc<0	wavelet compression, degree of compression= $ acc $
DIM add byte	
add = 0	default pixel addition
add = 1	no adding of adjacent pixels
add = 2	add 2 adjacent pixels
add = n, n < 16	add n adjacent pixels (remaining 512 mod n pixels also added)
DIM dog byte	
dog = 0	default setting of telemetry watchdog
dog = 15	disable telemetry watchdog for mode, max 1 hour

5 Examples of DFMS modes

To facilitate the definition of measurement sequences it is necessary to use a short-hand designation for specific modes. The simplest solution is to just consecutively number the modes. This requires that an updated table of modes is available to designate sequences. The numbering should however follow a few simple rules:

Many GAS and ION modes will be similar. The same holds for LOW and HIGH resolution modes, and for COM and NOI modes. The last digit of the mode number can be used for this (a similar system was used for classification of genetically related lunar samples). Thus the following last digits should be used for the following combination of function, task, and resolution:

- 0: GAS,COM,LOW
- 1: GAS,COM,LOW, background
- 2: GAS,COM,HIG
- 3: GAS,COM,HIG, background
- 5: ION,COM,LOW
- 6: ION,COM,LOW, background
- 7: ION,COM,HIG
- 8: ION,COM,HIG, background
- 9: NOI

The numbering should be arranged as follows:

- 0 to 49: Basic modes for switch on
- 50 to 99: Bake-out and other technical modes
- 100 to 199: Basic optimization and calibration modes
- 200 to 999: Standard survey modes
- 1000 to 1999: Modes specialized for scientific question
- 2000 to 9999: Custom modes

A low resolution gas survey mode would be defined by the following parameter set:

DFMS Instrument Modes_42_modified.doc
MAN-1010

D200: mode(GAS,COM,AMB{0,0,0,0},LOW{0},HIG,LOW,ZOO{0},MCP{10,30,
10,0,0},CON{13,140,18},TEL{0,4,0})

In this mode the instrument would switch to the measurement of cometary gas, using low emission (default filament) and high electron energy, low resolution, default zoom (zoom =1). The MCP detector would be used integrating for 65 ms and accumulating 30 readouts (time required 1.95 sec) which are accumulated in the DPU 10 times resulting in a total measurement time of 19.5 sec. The third sub-parameter specifies that the default setting for the post acceleration and MCP-LEDA potential are used. The fourth sub-parameter specifies default gain adjustments, i.e. GS only. For each different mass setting the MCP gain would be optimized that the largest peak is between 30 and 90 % of full scale. First mass 18 would be measured, then the range from mass 12 to 140 (Carbon to Xenon) covered in about 31 steps (each mass falls only once on the MCP), then 18 is measured again. The parameter TEL specifies that the default data compression schema is used, that rows A & B of the LEDA that 4 adjacent pixels are added and that the telemetry watchdog operates in the default mode. Assuming that the settling time for all voltages is < 1 sec and the MCP gain adjustment takes < 0.2 sec it would take about $33 \times 3.15 = 104$ sec to perform the mode.

A high resolution gas survey mode with higher emission to compensate for the lower transmission would be defined by the following parameter set:

D212:

mode(GAS,COM,AMB{0,0,0,0},MED{0},HIG,HIG,ZOO{0},MCP{10,20,10,2,0},CON{13,100,
18},TEL{0,1,0})

In this mode the instrument would switch to the measurement of cometary gas, using medium emission (default filament) and high electron energy, high resolution, default zoom (zoom = 4). The MCP detector would be used integrating for 65 ms and accumulating 20 readouts (time required 1.3 sec). 10 spectra would be accumulated by the DPU. The third sub-parameter specifies that no post acceleration is used and MCP-LEDA potential is inverted to get best mass resolution. The fourth sub-parameter specifies default gain adjustments, i.e. GS only. For each different mass setting the MCP gain would be optimized that the largest peak is between 30 and 90 % of full scale. First mass 18 would be measured, then the range from mass 12 to 100 (Carbon to) covered in 89 steps (each mass falls only once on the MCP), then 18 is measured again. The TEL parameter specifies the default data compression, that row A & B of the LEDA are added, no addition of pixels and default telemetry watchdog operation. Assuming that the settling time for all voltages is < 1 sec and the MCP gain adjustment takes < 0.2 sec it would take about $91 \times 2.5 = 230$ sec to perform the mode.

6 Possible Standard DFMS Modes

In the following a table of some proposed standard modes with designation etc

**The DFMS Instrument Modes are detailed in a separated document named DFMS_MODE_DESC.ASC.
This mentioned document includes the content of the page 18 to 30.**

7 Power Consumption in the different modes

The power consumption of DFMS is composed of five main components, namely of the standby power (low voltage converters and main controller), of the analyzer part, of the filament, of the ion source heater and of the cover motor. The power consumption of DFMS is more or less independent of the detector used. It does vary neither with low or high resolution nor with the zoom optics. The following table shows the four contributions:

	Power (W)
Standby mode (LVPS, MC)	16
Analyzer Part	1
Filament	2
Ion source heater*	12
Cover motor	2
RDP heater	1**

*Not run in parallel to analyzer part, filament or cover motor

** on, whenever $T_{LEDA} < 20^{\circ}\text{C}$

The power used in each mode can therefore be calculated. A normal measurement mode needs 19 W; a background mode (with the cover) 21 W, the ion source heater needs 28 W.

8 Mode Transitions

All mode transitions are controlled by the DPU.

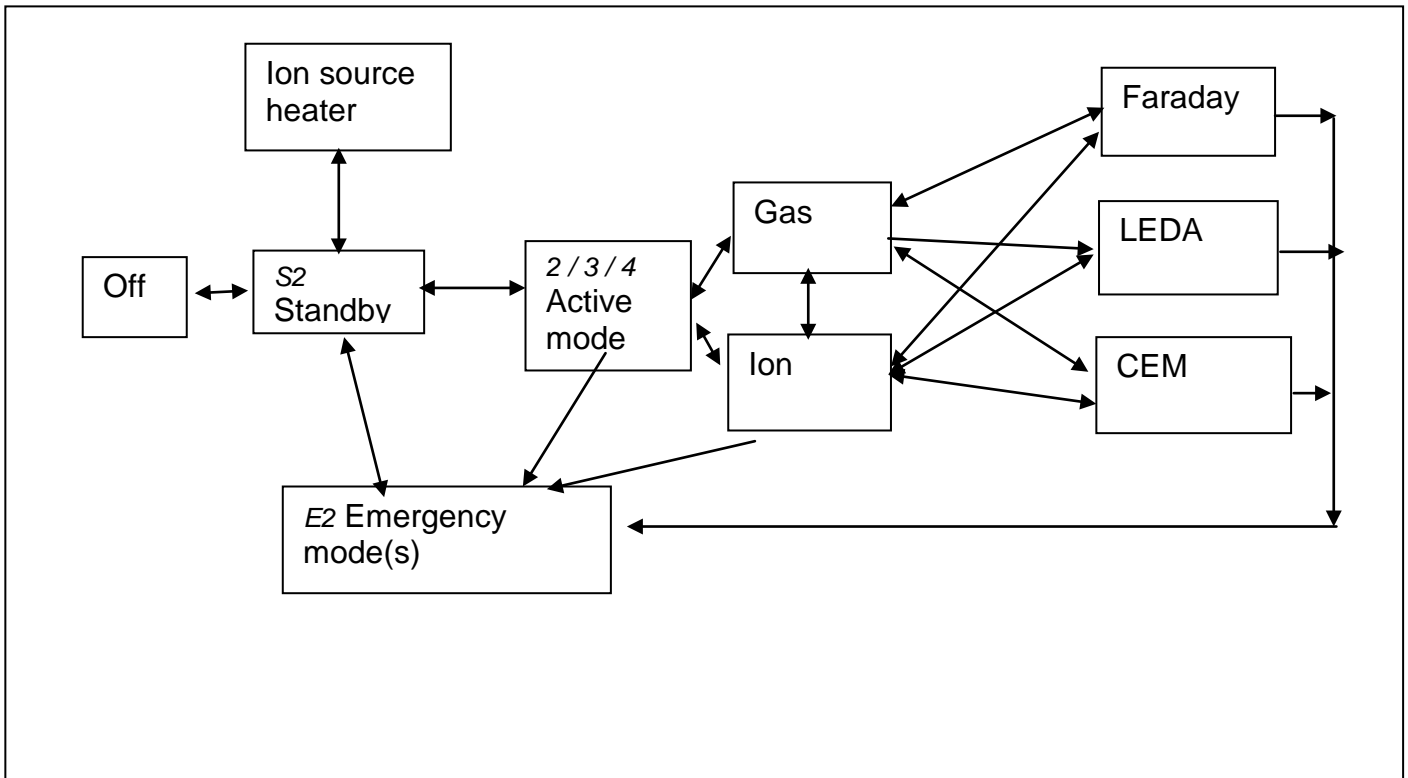

The three detectors of DFMS are not activated simultaneously. Whenever there is a change of detector between modes this involves therefore the disabling of one detector and the enabling of the other one. It is taken care of by the DPU that, whenever a detector is switched on, the gain is set to a low value, in order not to overload the detector. The gain is then subsequently adjusted.

8.4 From Standby to Ion source heater mode and vice versa

The ion source heater mode is activated by the DPU from the standby mode only. No transitions are foreseen from any active mode into this mode.

8.5 Transition into emergency mode E2

From all modes, a transition into the emergency mode(s) is possible. From the emergency mode the only transition allowed is into standby mode **S2 (TBC)**.

8.6 All other mode changes

All mode transitions not shown in the diagram (e.g. high resolution to low resolution, electronic noise to cometary gas measurement, optimization to detailed mass analysis, etc.) can be done without involving any intermediate modes. There are no mode transitions, which are forbidden, except the ones shown above. However, whenever a parameter is changed, the DPU will switch the gain of the detector used to a safe value, before changing the parameter and then it will adjust the gain to the actual peak level again.

9 Examples of DFMS measurement sequences

Modes can be combined to form measurement sequences. A few additional mnemonic commands facilitates this:

Repeated execution of modes is indicated by multiplication with integer. Example: Five times M100 is designated **5*M100**.

A waiting periode between modes (i.e. to let the ion source cool off) is designated by **W(waiting time in seconds)**.

Brackets can be used for repeated execution of a subsequence of modes.

It will be necessary to introduce also conditional statements such as **if..then..else.. endif** and **for..to..next** etc.

Standard survey sequence:

It is assumed, that the instrument was off for some time.

M50: 10 Minutes bake	<i>Time: 600 sec</i>
W(600)	<i>Time: 600 sec</i>
M0: Gas.DFMS switch on	<i>Time: 7 sec</i>
M200: Gas.Low Sens.Low Res.Survey.fast	<i>Time: 60 sec</i>
<i>A waiting periode to warm up and stabilize ion source etc. may be required.</i>	
if p < 1e-9 then	
M241: Gas.Med.Sens.Low Res.backgrd.detail	<i>Time: 300 sec</i>
M213: Gas.Med.Sens.High Res.backgrd.fast	<i>Time: 200 sec</i>
for i = 1 to 10	
M240: Gas.Med.Sens.Low Res.Survey.detail	<i>Time: 3000 sec</i>
M212: Gas.Med.Sens.High Res.Survey.fast	<i>Time: 2000 sec</i>
next i	
else	
M231: Gas.Low Sens.Low Res.backgrd.detail	<i>Time: 300 sec</i>
M203: Gas.Low Sens.High Res.backgrd.fast	<i>Time: 200 sec</i>
for i = 1 to 10	
M230: Gas.Low Sens.Low Res.Survey.detail	<i>Time: 3000 sec</i>
M202: Gas.Low Sens.High Res.Survey.fast	<i>Time: 2000 sec</i>
next i	
end if	
for i = 1 to 10	
M235: Ion.Low Res.Survey.detail	<i>Time: 3000 sec</i>
M207: Ion.High Res.Survey.fast	<i>Time: 2000 sec</i>
next i	
M236: Ion.Low Res.backgrd.detail:	<i>Time: 300 sec</i>
M208: Ion.High Res.backgrd.fast	<i>Time: 200 sec</i>
M10: DFMS standby on subemission	<i>Time: sec</i>

Total time for sequence about 13'000 sec (4 hours)

Sequence to measure 13C/12C in C:

It is assumed that the instrument was on in gas mode for some time at medium emission.

M200: Gas.Low Sens.Low Res.Survey.fast	<i>Time: 60 sec</i>
if p < 1e-8 then	
for i = 1 to 10	
M1002: Gas.13C/12C of C.meas.	<i>Time: 300 sec</i>
M1003: Gas.13C/12C of C.backgrd.	<i>Time: 300 sec</i>
next i	
end if	
M200: Gas.Low Sens.Low Res.Survey.fast	<i>Time: 60 sec</i>
M10: DFMS standby on subemission	<i>Time: sec</i>

Total time for sequence about 720 sec (12 min)



10 Data compression and telemetry (not yet updated)

The discussion in this chapter is based on an average data rate of 80 Mbits/day for the Rosina experiment. It is assumed that the data rate is shared 50:50 between DFMS and RTOF.

I assume, that the data from row A & B of the LEDA will normally be added. Before the addition can be made it is necessary to apply all pixel dependent corrections (gain, nonlinearity, pixel dependent transmission discrimination etc.). I assume, that these corrections might not be the same for the two rows. Also corrections for bad pixels must be applied before addition (procedure to be discussed). It might also be necessary to shift the data in row B by one or several pixels before addition if the masslines are not perfectly aligned with the pixels. If the data from both rows must be transmitted separately, then the data rate will double. The sub-parameter accuracy in the parameter TEL is used to specify the treatment of the two rows.

A DFMS spectrum will normally be acquired in about 2.5 s (1 s settling time, 0.2 s gain adjust, 1.3 s measuring time, see chapter 10). With an 8 bit logarithmic compression for the data in the pixel and 15 % overhead for housekeeping etc. this gives a data volume of $1.15 \times (512 \times 8) = 4710$ bit in 2.5 s, corresponding to 1884 bit/s. This is a factor 4.07 more than the possible continuous data rate of 463 bit/s. Additional data compression is thus required. Possible solutions are discussed in this chapter.

Any data compression schemes implemented in the DPU should be applicable to a large number, preferentially all measurement modes. Mode specific data compression schemes should not be implemented because of the large number of different modes.

No loss data compression

A no loss data compression algorithm should be used to compress the data volume as much as possible before it is sent to the s/c telemetry. The compression factor of such an algorithm is not fixed and depends on the data structure. I assume that at least a 20 % compression is (on the daily average) possible.

Compression of intensity information

The ADC counts from the readout of the LEDA pixels are accumulated in 24 bit registers and all 24 bits are transferred to the DPU. This large number of bits is required to allow the accumulation of a large number of readouts. For the transmission to earth a lower accuracy is sufficient and the following three logarithmic (or similar) data compressions should be implemented:

8 bit: An 8 bit about logarithmic compression covering the 0 to 4095 single range.

10 bit: An 10 bit about logarithmic compression covering the 0 to 4095 single range.

12 bit: An 12 bit about logarithmic compression covering the 0 to 4095 single range.

The MCP-LEDA data are from a 12 bit ADC. A certain number of integrations are added already in the detector electronics and the added values are transmitted to the DPU as integer. To facilitate data handling etc. the added data should be divided by the number of

accumulations and the resulting A/N values stored as single precision floating number. The LEDA background must be subtracted to obtain the true signal (also important for nonlinearity corrections etc. If additional corrections (flatfielding etc.) are applied by the DPU the resulting spectra should be renormalized to the 0 to 4095 range to obtain optimal resolution for the data transmission. Before renormalization the data from the two pixel rows A and B will normally be added. Renormalization factors, N values etc. must also be transmitted.

Similar to the compression algorithm used for the NMS the following simple logarithmic compression schemes could be used:

8 bit: $D = 21.25 \cdot \log_2(S + 1)$

10 bit: $D = 85.25 \cdot \log_2(S + 1)$

12 bit: $D = 341.25 \cdot \log_2(S + 1)$

with S = signal to be transmitted
 $0 \leq S \leq 4095$
 D = data value going to telemetry

For the values from the LEDA pixels S is essentially the number of accumulated counts A from the ADC divided by the number N of accumulations. Hence

$$S = A/N.$$

Before further data reduction the LEDA background (LBK) must be subtracted. The measured LBK could be used, but this might result in negative values. Hence, it is more appropriate to subtract the lowest value of S in any pixel from the A/N values:

$$S = A/N - \text{Min}(A/N).$$

The S values must then be corrected (flat fielding, non-linearity mass dependent transmission etc.), rows A and B added, pixels added etc.. The resulting values must then be renormalized to the 0 to 4095 range by again subtracting the lowest value from all other data and multiplying the corrected values by a suitable scale factor.

In the following three tables examples for the three different compression algorithms are given.

8 bit:

D	S	D	S	D	S
000	0.00	118	45.95	250	3478.60
001	0.03	119	47.50	251	3593.97
002	0.07	120	49.11	252	3713.17
003	0.10	121	50.77	253	3836.32
004	0.14	122	52.49	254	3963.55
005	0.18	123	54.26	255	4095.00

10 bit:

D	S	D	S	D	S

0000	0.000	0250	6.635	1018	3931.822
0001	0.008	0251	6.697	1019	3963.929
0002	0.016	0252	6.760	1020	3996.298
0003	0.025	0253	6.823	1021	4028.931
0004	0.033	0254	6.887	1022	4061.832
0005	0.041	0255	6.951	1023	4095.000

12 bit:

D	S	D	S	D	S
0000	0.000	0695	3.103	4090	4053.612
0001	0.002	0696	3.111	4091	4061.856
0002	0.004	0697	3.120	4092	4070.116
0003	0.006	0698	3.128	4093	4078.394
0004	0.008	0699	3.136	4094	4086.689
0005	0.010	0700	3.145	4095	4095.000

For the 8 bit compression the steps are factors of 1.033 for larger signals (factor < 1.04 for A/N > 5.01). Thus the error due to the compression is smaller than about +/- 1.5 %. For the 10 bit compression the steps are factors of 1.008 for larger signals (factor < 1.01 for A/N > 4.43). Thus the error due to the compression is smaller than about +/- 0.4 %. For the 12 bit compression the steps are factor of 1.0020 for larger signals (factor < 1.0025 for A/N > 4.90). Thus the error due to the compression is smaller than about +/- 0.1 %.

Most of the data obtained by the DFMS will not require the high accuracy of the 12 bit scheme. It will be extremely difficult to calibrate the MCP-LEDA detector with this very high precision. Only some very special modes which use only a limited number of pixels with signal intensities limited to the linear range of the MCP, for instance for measuring isotopic ratios, might require the 12 bit accuracy.

Low resolution spectra

The entrance slit used in the low resolution mode is 200 micron wide. The magnification of the analyzer is 1.56 (zoom = 1). The image of the slit in the MCP plane for perfect focussing conditions is 312 micron wide. Thus, without loss in resolution, the data in several pixels can be added. However, it is important, that all pixel dependent corrections are done before the adding. Pixel dependent corrections are: flat fielding, nonlinearity correction, pixel dependent transmission correction. If the data from 4 adjacent pixels are added, the a single mass peak is still at least 4 pixels wide.

High resolution spectra

The MCP-LEDA detector does not lay on the focal plane. High resolution spectra can only be obtained around the intersection of the ion-optical center line of the analyzer with the MCP-LEDA detector. Furthermore, mass multiplets deviate only by a few ten mAMU from integer masses. For instance at mass 44 the range is from 43.990 AMU (CO₂) to 44.063 AMU (C₃H₈). The range covered by the multipletts will increase with mass as for heavier

mass molecules more H-atoms may be present. However, the relative range dM/M covered by the multiplets is constant or even decreasing with mass and hence the number of pixels covered by the multiplets will be essentially mass independent. The spectrum of the $\text{CO-N}_2\text{-C}_2\text{H}_4$ multiplett recorded on 16. Feb. 2000 with the DFMS EQM with zoom = 6.2 shows, that it is sufficient to transmit the data in about 80 pixels (tbc).

It is probably possible to shift the ion-optical centerline away from the geometrical centerline of the instrument and obtain reasonably good focussing conditions on the MCP plane. Hence, high resolution spectra could also be obtained centered away from the center of the MCP. This might become necessary if the center of the MCP becomes degraded after prolonged use. The DFMS OS must be able to handle such a situation.

Telemetry watchdog

As the data rate from the instrument can vary strongly depending on the instrument mode and as the compression ratio of the no-loss compression algorithm varies depending on the data it is necessary to implement a telemetry watchdog. The watchdog must check, that the average data rate from the DFMS sent to the telemetry is within the 40 Mbits/day allotted to the sensor. As the s/c telemetry has a large storage capacity the instantaneous data rate may be above the average 463 bit/s. However, the average data rate over longer periods (1 day, tbc) must be within the capacity of the telemetry. Thus for 1 hour the data rate sent to the telemetry could well be several times the allowed 1.67 Mbits/hour, provided before or after the data rate is correspondingly lower than the 1.67 Mbit/hour. Thus the watchdog will have to keep track of the data sent to the telemetry and also make "educated" guesses about the data volume of the next several hours. If the watchdog senses a long term build up of a data overload of the telemetry it has to slow down the data rate of the instrument. The watchdog has to decide on the magnitude of the necessary slow down factor. It is proposed to use slow down factors of 1, 1.2, 1.5, 2, 3, 5, 10 etc. It does not seem necessary to me, to implement slow down factors higher than 10, except if the s/c has a emergency telemetry mode with very low data rate.

The s/c telemetry must also inform the watchdog on the status of the telemetry transmission, especially about the backlog in the data transmission and unusual events which could lead to a reduced data rate (for instance loss of communication etc.). This information is necessary, as the telemetry watchdog must also take the status of the s/c telemetry into account when making decisions.

Question: Is this information available

When data are acquired with the MCP-LEDA detector the easiest way to slow down the data rate would be to increase the number of accumulations by the slow down factor. Hence only accumulation numbers which are divisible by 10 should be used. As the expected slow down factors for standard instrument modes are small, the impact on the science should be minimal. For custom modes the TEL parameter can be set accordingly to prevent data loss. This must be done with care to avoid a major back up of data in the s/c telemetry.

When the data are acquired with the CEM or Faraday detector the data rate are one to two orders of magnitude lower than with the MCP-LEDA. It is probably not necessary to implement slow down factors for these two detectors. If necessary, integration times could be prolonged.

Data rate with above discussed compression

For the following examples I assume 2.5 s acquisition time for 1 full spectrum (1 s settling time, 0.2 s for GS adjustment, 1.3 s data acquisition corresponding to 20 accumulations with 65 ms integration time). The necessary housekeeping data (HK) per spectrum are estimated to be 256 bits (32 bytes) for low resolution and 384 bits (48 bytes) for high resolution.

Low resolution: With the addition of 4 consecutive pixels and 8 bit data compression the telemetry budget is:

Data:	$8 \times 512 / 4 = 1024$	bit
HK	256	bit
TOTAL	1280	bit
after compression	$0.8 \times 1280 =$	1024 bit
Telemetry rate		410 bit/s

Low resolution: With the addition of 4 consecutive pixels and 10 bit data compression the telemetry budget is:

Data:	$10 \times 512 / 4 = 1280$	bit
HK	256	bit
TOTAL	1536	bit
after compression	$0.8 \times 1280 =$	1229 bit
Telemetry rate		492 bit/s

Low resolution: With the addition of 4 consecutive pixels and 12 bit data compression the telemetry budget is:

Data:	$12 \times 512 / 4 =$	1536 bit
HK	256	bit
TOTAL	1792	bit
after compression	$0.8 \times 1792 =$	1434 bit
Telemetry rate		574 bit/s

High resolution: Only transmitting the data from the center 80 pixels and using 8 bit data compression the telemetry budget is:

Data:	$8 \times 80 =$	640 bit
HK	384	bit
TOTAL	1024	bit
after compression	$0.8 \times 1024 =$	820 bit
Telemetry rate		328 bit/s

High resolution: Only transmitting the data from the center 80 pixels and using 12 bit data compression the telemetry budget is:

Data:	$12 \times 80 =$	960 bit
HK	384	bit
TOTAL	1344	bit
after compression	$0.8 \times 1344 =$	1076 bit
Telemetry rate		431 bit/s

Conclusion:

Except for the low resolution, 10 and 12 bit cases the resulting data rate is lower than the telemetry capability of 463 bits/s. If 5 consecutive pixels are added the data rate would be reduced to 410 respectively 476 bite/s. An other solution - preferred by me - would be to use 30 instead of 20 accumulations. The time per spectrum is then $1 + 0.2 + 1.95 = 3.15$ s and the data rate 391 respectively 456 bit/s, thus compatible with the possible telemetry rate.

Wavelet compression:

If the parameter acc is set to a negative value wavelet compression will be used. The degree of the compression is given by |acc|. TBD, TBC

11 Background spectra

In this chapter a brief discussion of background spectra and associated problems is given. For the discussion I distinguish between two types of background: background signals not associated with an actual ion current ("masses") in the instrument. Sources for this type of background are: Noise on the MCP, bad pixels on the LEDA, readout noise of the LEDA, spurious counts of the CEM, dark current of the CEM in analogue mode, electrometer noise of the CEM and Faraday electrometers. Background in the mass spectra: Ions not due to the primary cometary gas or ions. Reflected ions.

LEDA bad pixels and readout noise : This should be determined once per mode, at the beginning of the mode. All voltages are set to the nominal values for the first measurement, except for the MCP voltage which is set to a low value. One integration (6.5 ms) and one accumulation should be enough. Bad pixels (zero or full scale output) are entered in the bad pixel map.

MCP noise: The MCP noise is determined by setting all voltages to nominal values for the mode and suppressing the ion beam in the instrument. The MCP noise will depend on the gain step, the MCP-LEDA voltage (normal or inverted) and perhaps also on the postacceleration. Based on the experience with the NMS I do not expect that the MCP noise, if present, is stable and reproducible to be used for correction of the science data. It will depend on the presence of hot spots on the MCP. Hence the MCP noise data are more diagnostic and can not be used for a reliable direct noise correction. Based on the MCP noise data it will be possible, to optimize the position of the mass spectra on the MCP to avoid a peak falling in a noisy region of the MCP.

A strong effort should be made to select MCPs which are essentially **noise free!**

CEM noise: The noise (spurious counts) on the CEM could be determined in a similar way to the MCP noise. However, measurements with the CEM will be done by scanning a mass peak across the CEM slit. This scan must include baseline data on both sides of the peak as scattered ions etc. can contribute also to the baseline. A separate CEM noise determination seems therefore unnecessary, except for diagnostic purposes.

Faraday noise: The noise of the Faraday collector and associated electrometer could be determined in a similar way as the MCP noise. However, measurements with the Faraday will be done by scanning a peak across the Faraday slit. This scan must include baseline data on both sides of the peak as scattered ions etc. can contribute also to the baseline. This holds also for the high resolution case (see chapter 7). A separate Faraday noise determinations seems therefore unnecessary, except for diagnostic purposes.

Background mass spectra: cometary ions: When measuring cometary ions the background from other sources is expected to be small. Possible sources of ions which are not primary ions are:

- a.) Ions originating from the s/c or from other experiments.
- b.) Ions originating from the ionization of gas emanating from the s/c or the experiment and from the ionization of backscattered cometary gases.
- c.) Ions originating from within the experiment, for instance from the impact of fast (cometary) neutrals, UV and X-rays etc and also from an imperfect subemission. Sources a.) and b.) will be difficult to determine and it is probably not feasible to implement before launch routine modes for checking this type of background. Source c.) can be determined by suppressing the entry of ambient ions into the ion source region. The necessary change in source potentials may have some influence on this type of background ions.

Background mass spectra: cometary gas: For the interpretation of the gas mass spectra it will be mandatory to distinguish the different sources contributing to the individual mass peaks. These sources are:

- a.) The cometary gas entering as a molecular beam through the entrance baffle system (either wide or narrow field of view) into the ionizing region.
- b.) The cometary gas entering as a molecular beam through other openings (for instance between ion source and ion source cap housing of the DFMS and diffusing into the ionizing region.
- c.) Cometary gas reflected from the experiment platform and other s/c or experiment parts and entering the DFMS ionizing region.
- d.) Outgassing from the DFMS (source, analyzer, and other parts).
- e.) Outgassing from the s/c or other experiments.

Closing partially or fully the cover of the DFMS is a poor substitute to a flag. The closing of the cover will switch off source a.). However, it will also substantially influence all other sources. b.) will also be switched off. c.), especially for a half closed cover will be increased by orders of magnitudes, for a fully closed cover it will probably still be enhanced (reflection of gas molecules on cover parts, a 1 mm gap around the circumference of the cover still has a conductance of 50 l/s). d.) will be enhanced by the closing. e.) will be strongly enhanced by orders of magnitude during closing. In the fully closed position it probably still will be enhanced.

12 On board data reduction

As outlined in chapter 13 the data compression required to fit the instrument data flow to the telemetry capability requires essentially no on board data reduction. However, other tasks such as the instrument optimization and also the adjustments necessary on the external potentials for measuring cometary ions require on board data reduction. The main

task will be - after making the necessary corrections - to isolate from the data (MCP-LEDA, CEM, or Faraday) the individual (isolated) mass peaks, to determine their area and shape parameters, and to assign them the mass. These must then be stored for further use together with the relevant instrument parameters.

As an option it is necessary to transmit the output from this algorithm to ground.

13 Hidden measurements

In addition to the measurements specifically designated by the selected mode the DFMS must also make certain hidden measurements:

As first measurement in performing a specific mode the LEDA noise is measured (LBK). (see Appendix A)

For high resolution modes the instrument must check and if necessary correct the mass scale before making the measurements. This may involve measuring two masses (18 and 44, masses **tbc**, reference masses might be changed in flight depending on cometary gas composition) in low resolution, using a default mass scale appropriate for the actual magnet and electronics temperature.. In low resolution the full MCP can be used for locating the mass peak. In low resolution the mass peaks will be considerably broader but it should still be possible by fitting an appropriate peak shape to determine the peak center with an accuracy of M/dM of the order of 1000 (this should be tested). Using this preliminary mass scale the same two mass peaks are then measured with high resolution and the definite mass scale is established. Experience will show if the individual steps have to be repeated to obtain the final mass scale.

Before switching on of the filament or any high voltage the DPU must check the ambient pressure as derived from COPS, from the most recent measurements of DFMS and RTOF. It must also check, that both GCUs have pirani readings **< 1 mbar (tbc)**. These checks must be repeated at the beginning of each mode and/or at regular time intervalls (intervall = updating intervall of **COPS tbc**).

The following HK data should be transmitted in full with every spectrum as their values will be used in the mass identification:

MAG_Temp	Magnet temperatur	12 bit (tbc)
ESA0_VMON	Outer ESA voltage	18 bit (tbc)
ESA1_VMON	Inner ESA voltage	18 bit (tbc)
GS	Gain step of MCP or CEM or FC	04 bit

These HK data require a total of 52 bit or 13 byte (tbc). For these HK data no flag is required.

There are some HK values which have no nominal value. These are:

- Ion source temperature
- LEDA-MCP temperature
- Filament current
- Filament voltage
- Trap current
- CEM current
- MCP current

These are all values which will change only slowly with temperature and time and are not critical for the interpretation of the data. The last transmitted value (with the mode or at fixed interval, see below) will be used as nominal value. The CEM and MCP current depend on the GS. The DPU must calculate from the last transmitted current values the appropriate current values for all gain steps.

For the task **CAL** additional HK data from must be transmitted with each spectrum. These are:

GCU_Out_Pres#X

GCU_Temp#X.2

with X designating the active GCU system (number 1 or 2).

Appendix A: Detector operation requirements for the DFMS flight software

Original by: Jean-Jacques BERTHELIER, CETP

Jean-Marie ILLIANO, CETP

Dennis NEVEJANS, BIRA

Adapted by: Dennis NEVEJANS

tel. & voicemail: +32-2-373.0482

email: Dennis.Nevejans@bira-iasb.oma.be

Institute: Belgian Institute for Space Aeronomy
BIRA-IASB
Ringlaan 3
B-1180 Brussels
Belgium

Document change record

Issue	Issue date	Paragraphs affected	Reason for change
1.0	Nov 7 2000		Draft
1.1	Nov 16 2000		After review by J.M. Illiano
1.2	Nov 30 2000	Intercalibration	Remarks by PI team
		New paragraphs	

Scope

This document describes some flight software requirements related to the operation of the DFMS detector.

13.1 Reference document

Document ROS-BIRA-SP-06 issue 1.8 dated Feb 7 2000 contains all the fine details of the commanding of the DFMS detector subassemblies, except the CEM.

13.2 MCP related operations

13.2.1 Fundamental operations

Two commands must be issued to set the MCP back and front high voltage values:

- Set MCP-back by issuing command **SetFdpDac** (mnemonic SFD, opcode 17) with the appropriate parameters.
- Set MCP-front by issuing command **SetFdpDac** (mnemonic SFD, opcode 17) with the appropriate parameters.

The corresponding voltages must be applied in this order since we must be guarantee that the MCP-back voltage does not acquire unwanted, too high values that can damage the MCP-LEDA combination (electrical breakdown).

One command must be issued to enable/disable the MCP high voltage supply:

- Enable the MCP supply by issuing command **EnDisHv** (mnemonic EDH, opcode 6) with the appropriate parameter
- Disable the MCP supply issuing command **EnDisHv** (mnemonic EDH, opcode 6) with the appropriate parameter

See below for the explanation of the effect of the **EnDisHv** command in combination with safety measures. Before enabling the MCP supply MCP-back and MCP-front must be set to appropriate start-up values.

13.2.2 Safety aspects

Each command sent to the FDP-B FPGA MCP consists in a 5-bit opcode + a 16-bit parameter field + a 6-bit attachment.

The 6 attached bits, organized as two triplets, are used to ensure safe operation of the MCP under all conditions.

Their function is explained in detail in ROS-BIRA-SP-06 and more specifically in the description of command EnDisHv.

13.2.2.1 *Bit triplet "HV SAFE"*

- For safety reasons the HV safe/unsafe condition is obtained through a majority logic decision of the 3 triplet bits.
- The HV unsafe condition is used during ground operations when no HV voltage should be applied to the MCP. Under such conditions the "HV safe" connector must be present. In flight conditions there is no connector. (*or an unwired connector ?*).
- The HV safe/unsafe condition is combined with the enable/disable function of the **EnDisHv** command in a logical **AND** function, which means that it overrides an earlier enabling of the MCP HV supply as soon as **any** new command with an appended UNSAFE triplet is issued.
- The bit triplet is activated through the "HV safe" connector located in the main electronics, which is at spacecraft potential. The main electronics takes the connector presence into account and appends the bit triplet to each command sent to the FDP-B FPGA via FDP-C, at FDP potential. In fact the triplet is acting as an emulation of a wire connection carrying the HV safe/unsafe condition.

13.2.2.2 *Bit triplet "HV reduced"*

For safety reasons the HV normal/reduced condition is obtained through a majority logic decision of the 3 triplet bits.

- The HV reduced condition is used during ground operations when a reduced HV voltage should be applied to the MCP. The reduction factor is fixed. Under such conditions the "HV reduced" connector must be present. In flight conditions there is no connector. (*or an unwired connector ?*).
- The HV normal/reduced condition is acting immediately on the MCP HV supply as soon as **any** new command with an appended REDUCED triplet is issued.
- The bit triplet is activated through the "HV reduced" connector located in the main electronics, which is at spacecraft potential. The main electronics takes the connector presence into account and appends the bit triplet to each command sent to the FDP-B FPGA via FDP-C, at FDP potential. In fact the triplet is acting as an emulation of a wire connection carrying the HV normal/reduced condition.

▪

13.3 LEDA related operations

13.3.1 Setting of integration time

The integration time is the time between two successive read-outs of the LEDA512.

The unit period for the integration time is 6.554 ms.

The actual integration time of the LEDA is $N_i \times 6.554$ ms.

N_i ranges from 1 to 4095 and is contained in the onboard LU table associated with each science mode.

N_i can be changed by sending a **SetIntegrationTime** command to the FPGA located on FDP-B.

13.3.2 Starting an accumulation with a given number of accumulations

Data from LEDA readouts are accumulated in the FPGA memory located on FDP-B before being sent to TM.

The number of accumulations N_A ranges from 1 to 4094 (take care: the parameter in the opcode is 2 to 4095) and is contained in the LU table associated with each science mode

N_A can be changed by sending a **StartSpectrumAccumulation** command to the FPGA located on FDP-B.

Remark :

During an accumulation session of the LEDA there is always a hidden readout cycle only used to reset the anodes and to clear the accumulation memory zones 2, 3 and 4. It is not taken into account in the number of accumulations.

13.3.3 Accumulation memory zones

There are 4 zones:

- **Zone 1:** 512 Mask bits, they define the anodes of the LEDA that must not be taken into account while searching for the peak among anode data. Since the FPGA memory is volatile, this Mask bit (or "Bad Pixel map") must be also stored in the non-volatile DPU memory and sent to FPGA **after each power-up** of the FDP boards.
- **Zone 2:** accumulated data from LEDA-A
- **Zone 3:** accumulated data from LEDA-B
- **Zone 4:** two 16 bits words representing the maximum of the anode data for LEDA-A and LEDA-B respectively. The maximum stored during an accumulation session are the maximum of all maxima obtained after each readout.

Remark:

As agreed the accumulation memory zones 1 and 4 associated with the detection of peak values in mass spectra by elimination of "bad pixels" in the FPGA hardware will not be used. Instead a software algorithm running in the DPU will take over this task.

13.3.4 Reading commands

Command **ReadLedaMemory** is used to read the contents of the different zones of the accumulation memory.

Selection by command allows to read either LEDA-A alone, or LEDA-B alone or LEDA-A and LEDA-B. In the nominal case of a fully operational LEDA512 one would normally read parts A and B of the LEDA512 with a single command. In the emergency case when half of the LEDA512 is dead either part A or part B can be read.

The memory zones 2 and 3 contain accumulated anode data as 512 4 byte words. In order to optimize (= reduce) the transmitted data flow between the RDP and the DPU it is possible, by tuning the parameters of the **ReadLedaMemory** command to read only 1, 2, 3, or 4 bytes of each data word. This can be used in periods of low cometary gas density.

Command **ReadLedaMemory** should not be used without first checking that accumulation is completed by issuing command **ReadAccumulationStatus**. This check should preferably be performed after a time-out equal to the expected duration of the accumulation process + overhead.

13.4 Operations related to the MCP-LEDA combination

The sequential list of actions required to operate the detector for any science mode is as follows:

13.4.1 Temperature test

Before the MCP-LEDA detector is put in operation the following temperature check should be performed:

- If LEDA temperature $> T_{\max}$ (+30 °C): do not operate the MCP detector because of possible thermal runaway condition.
- If LEDA temperature $< T_{\min}$ (-30 °C): do not operate the MCP detector because of too high MCP resistance and hence linearity limitation.

See also RDP heater operation requirements hereafter.

In case of $T_{\text{LEDA}} > 35$ °C DFMS is automatically switched off (1/2005)

13.4.2 Offset of FDP-A ADC

Set FDP-A ADC to appropriate offset value by means of **SetFdpDac** command and by using the offset algorithm (which might be different for the normal and the inverted mode of operation of the MCP-LEDA combination). See appendix C

The offset is currently set to 20 for FM and FS (1/2005)

13.4.3 Bad pixel map initialization

At the start of a sequence of measurements, check the validity of the Mask bit table stored in the DPU.

Do 3 consecutive LEDA readouts with LEDA in normal mode (LEDA-A, LEDA-B or LEDA A and B, according to LEDA status) under initial MCP HV conditions (see 13.4.6.1).

Identify the bad pixels by a majority logic decision over 3 measured values, a pixel being bad if its value is 0 (TBC) or 4095 (TBC).

Modify the Mask bit table in the DPU accordingly if commanded from ground (TBD).

Optional, since not used anymore:

Clear the mask bit zone in the accumulation memory on FDP-B by issuing command **ClearMaskBits**
Send the Mask bit table from DPU to the FPGA on FDP-B by issuing command **PutMaskBit** for each particular anode to be masked out.

13.4.4 LEDA background measurement

The LEDA background is obtained during determination of the bad pixel map in paragraph 13.4.3.

13.4.5 DFMS voltage setting

13.4.6 MCP HV automatic gain control

The role of this step is to reach the optimal MCP HV by increasing the HV from a safe initial value HV_0 .
See appendix D

13.4.6.1 *Assumptions:*

It is assumed that a single **MCP HV-Gain Conversion** LU table (valid for all temperatures) contains 16 (TBC) MCP Front HV values, each step N to N + 1 corresponding to an increase of the MCP gain by a factor K equal to approximately 3 (TBC).

MCP HV value	MCP gain
HV_0	G_0
HV_1	$G_1 = G_0 * K$
HV_2	$G_2 = G_1 * K = G_0 * K^2$
...	...

We call p_L the elementary linearity threshold for the LEDA measurements in the case of the minimum integration time of 6.554 ms and 1 accumulation. This value is related to the amount of charge extracted from the MCP, which may not surpass a given percentage of the MCP supply current. The latter being highly temperature dependent p_L must be temperature corrected.

Therefore a p_L LU table is established which stores its value, expressed in LEDA ADC code, for 10 (TBC) different temperatures.

MCP temperature (= LEDA temperature)	Linearity threshold p_L expressed in ADC code
T_1	p_{L1}
T_2	p_{L2}
...	...

The actual MCP temperature T ($T_i < T < T_{i+1}$), deduced from the LEDA temperature, is used to compute the corrected value of p_L by interpolation:

$$p_L = p_L(i) + (p_L(i+1) - p_L(i)) * (T - T_i) / (T_{i+1} - T_i)$$

p_L is in the range 0 to 4095. If p_L is > 3500, then $p_L = 3500$ in order to leave some margin.

13.4.6.2 *First action*

Set the MCP HV to HV_0 .

13.4.6.3 *Second action – Gain adjust algorithm*

Execute the following Gain Adjust Algorithm. (see also appendix D)

The first measurement at the initial gain setting of G_0 provides a peak value p_M for the maximum on the anodes (see 13.4.3). This peak value must be scaled to 1 accumulation and the shortest possible integration time, hence:

$$p = p_M / (N_A * N_i)$$

- If p is greater than a threshold p_T (TBD), the ratio p_L/p provides the factor by which the gain has to be multiplied to get the optimal setting. The actually adopted value for the gain step is the one which provides a gain equal to or smaller than the optimal gain.
- If $p < p_T$ increase the gain step from G_0 to G_0+3 , hence take next entry in MCP HV-Gain conversion table, and determine p again.

Remark:

It is assumed here that the look-up table contains only MCP gain values which are safe, in order to protect against reaching excessive gain when no peak is present.

13.4.6.4 Termination of operations:

If no further operations are planned at the end of a science sequence all voltages in the DFMS as well as the HV MCP shall be reset to "safe" values.

The simplest approach is to have a fixed safe HV_0 value in the LU table. Its value will be much too safe for the low flux case and the number of steps in the gain adjust algorithm will be consequently large; but for a long duration experiment this is probably the way to go.

13.5 MCP/LEDA – CEM - FC intercalibration:

The intercalibration of the 3 different detector types should be handled as a normal measurement so as not to disturb anything that may falsify the result; this means:

- CEM OFF during MCP/LEDA calibration
- MCP OFF during CEM calibration
- MCP and CEM OFF during FC calibration

However, during the interval of time between the CEM and the MCP measurements the ion beam shall be shut off by means of the ESA in order to prevent the occurrence of a different mass peak on the CEM or MCP without appropriate gain adjustment.

13.6 MCP/LEDA gain calibration scan:

The possibility to scan a mass peak over the MCP in order to recalibrate the gain of the pixels is of utmost importance.

It should be conducted on a regular basis (every week, 2 weeks, TBD...) and by means of:

- at least 3 peaks with significantly differing intensities, for example H_2O , N_2/CO , NH_3
- or with a single peak in the neutral mode (H_2O is the best candidate), but with a varying emission current in the source. The reason for this is that the profile of the MCP gain varies with the applied HV and thus this gain profile must be regularly checked with at least 3 MCP HV voltages which should correspond to a gain of 10^6 , 10^5 , 10^4 .

Presumably the use of the single H_2O peak in neutral mode is easier if the fluxes are high enough. This mode of operation is in fact dependant on the operation of the DFMS spectrometer by itself (scan of the optics voltages and the emission current), not on the operation of the detector which stays similar to a normal mode of operation.

13.7 MCP burn out protection:

Ideally one can think of a solution where aging of the MCP is done regularly over the whole surface: this means scanning the peak over the MCP during each mode.

This can be done in two ways:

- By changing the peak position after each LEDA data taking (this is of the order of less than 1 to a few seconds at most) and doing that during the whole sequence corresponding to a mode which lasts normally 1 to several minutes.
- By changing periodically (every month or 2 months, may be less near perihelion, this is TBD) the LU tables which define the peak position for all the modes of operation. In this way the peak position is changed accordingly and aging is "continuous" over steps of a month or so.

The second method is the least complicated and has at least 2 advantages:

- There is no special S/W to write.
- One can be clever in changing the peak position (i.e. the LU table) so as to favor not only a quasi continuous aging over the whole active area of the MCP but also to move it in order to acquire the most interesting data (i.e. it can be better science wise to look on the left of a peak than on the right).

One must understand that the parameters that define the operation of the MCP (in particular the maximum peak height in the automatic gain control) can also be adjusted to be on the safe side and provide a long enough reliable operation. Again, no special S/W, only a careful use of parameters which are in the LU table.

13.8 RDP heater operation:

It would be very desirable if the heater located on RDP-FLI, immediately below the DFMS detector flange, could be used to control the temperature of the MCP-LEDA combination.

- If LEDA temperature $< T_{\text{nominal}}$ (+20 °C) enable RDP heater until LEDA temperature has reached T_{nominal} .
- Loop around this temperature with hysteresis (Switch off of RDP heater occurs at 25 °C).
- Disable RDP heater when LEDA temperature $< T_{\text{nominal}}$ AND $T_{\text{RDP}} > +50$ C in order to protect RDP electronics.

Remark:

Since the commanding of the RDP heater is by means of commands sent to FDP-RDP, it is clear that command sending may produce noise during measurements. Therefore the enabling/disabling of the heater should only be performed before or after a measurement. This should be no problem since the slope of temperature changes is slow.

14 Appendix B: SEL Table

Entry #	Mode	M1	M2	M3	M4	M5	M6	M7	M8	M9	M10	M11	M12	M13	M14	M15	M16	M17	M18	M19	M20	M21	M22	M23	M24	M25	M26	M27	M28	
0	GCU	44	28	20	132																									
1	GCU-Mode	44	45	28	22	20	16	13	12	44	132	128	129	130	131	132	133	134	136	66										
2	Water	18																												
3	CO2	44	45	28	22	16	13	12	44																					
4	Ne	20	22	20																										
5	Xe	132	128	129	130	131	132	133	134	136	66	132																		
6	Cometary gas	18	28	44																										
7	I3C	12	13	12	13	12																								
8	M28	28																												
9	CO2	44	45	28	22	16	44																							
10	GCU-Mode	44	45	28	22	20	16	44	132	128	129	130	131	132	133	134	136	66	44											
11	M15.5	15.5																												

15 Appendix C: LEDA Offset Algorithm

For the inverse mode the offset is set to 500.

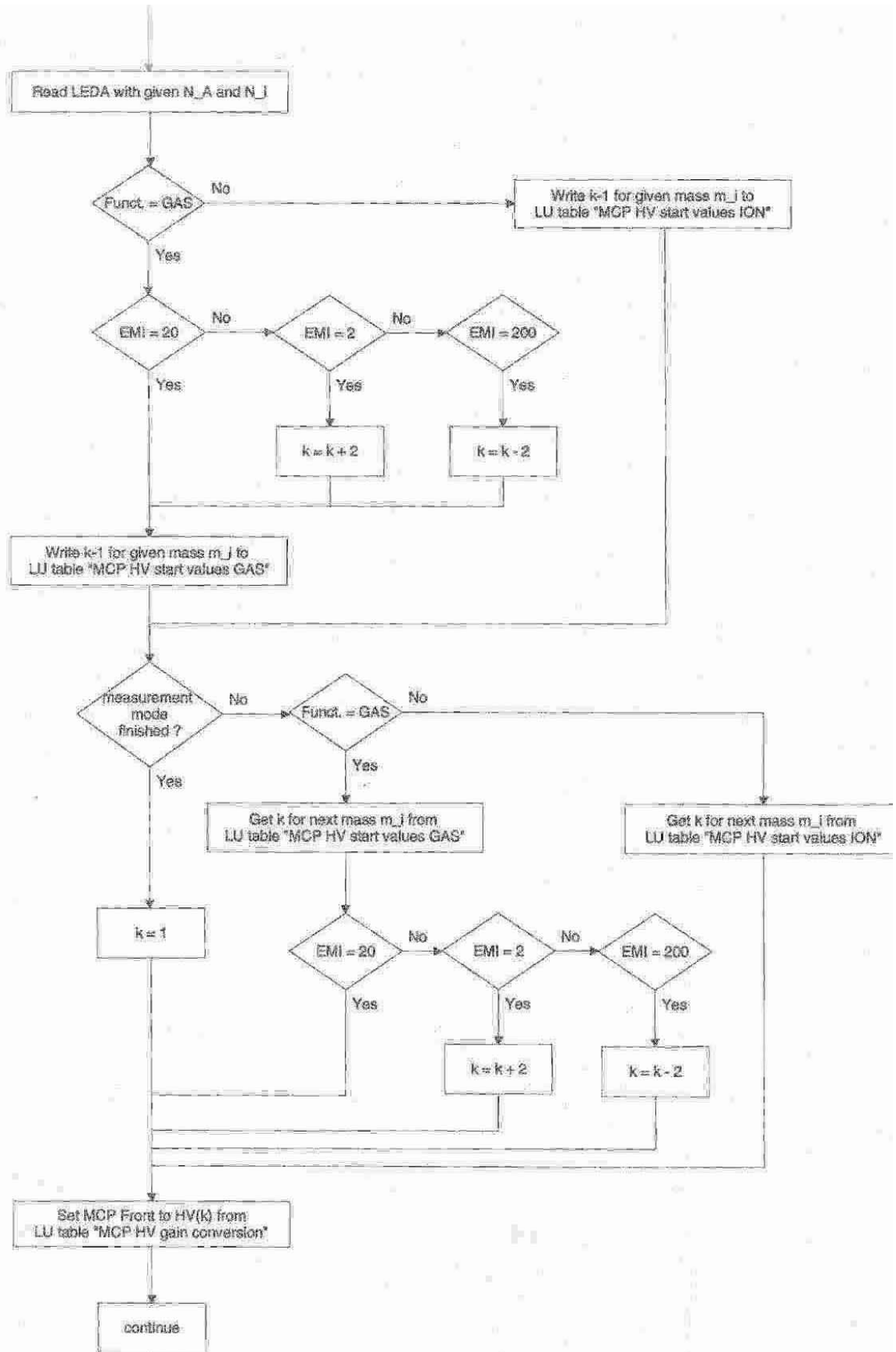

16 Appendix D: Gain adjustment algorithm for LEDA

"Automatic gain adjustment mcp"

MCP Front has been set either to its lowest safe value ($k=1$) or after the previous step of the current measurement mode to a certain mass dependent value ($k=f(\text{mass})$).

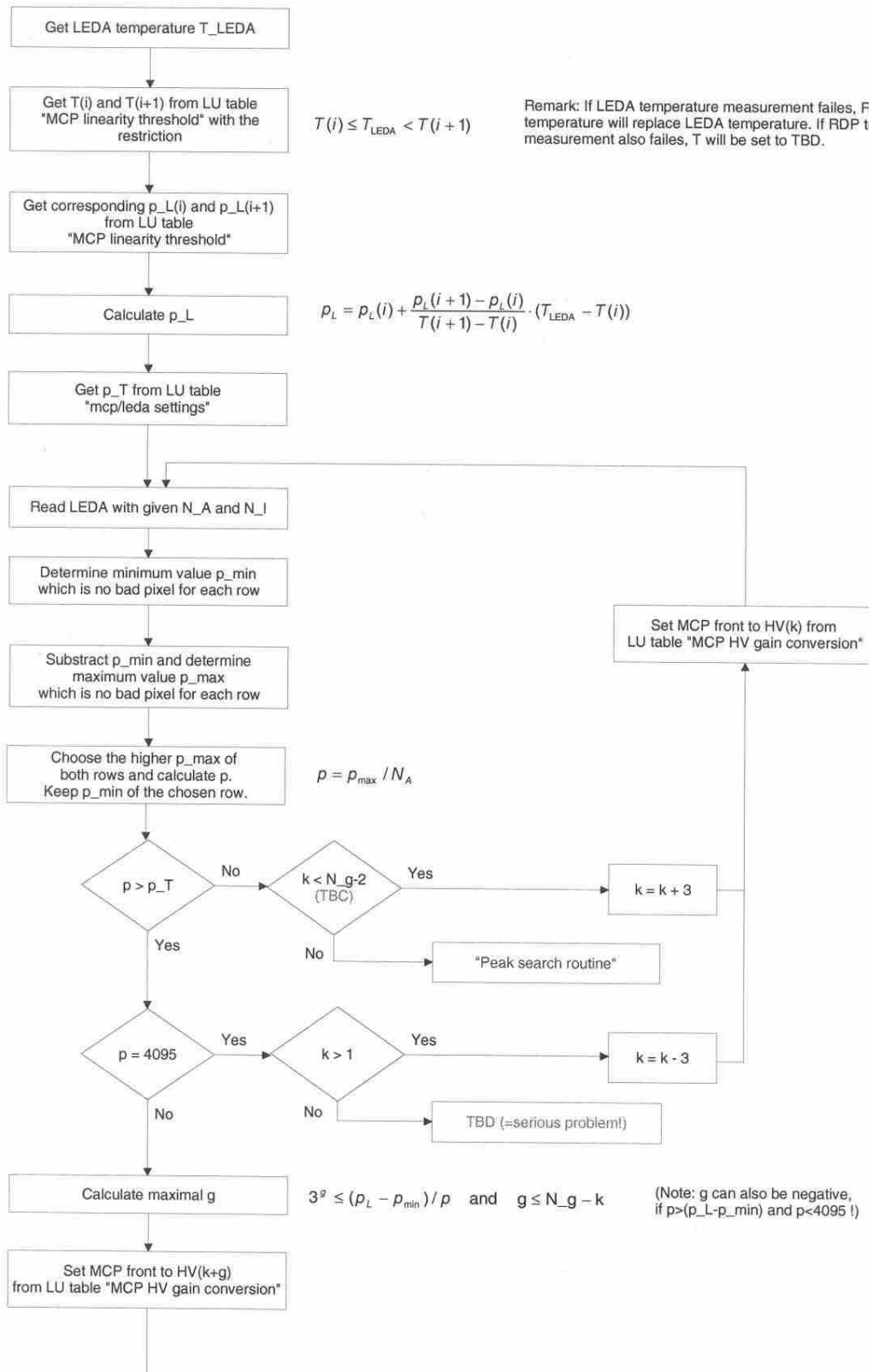

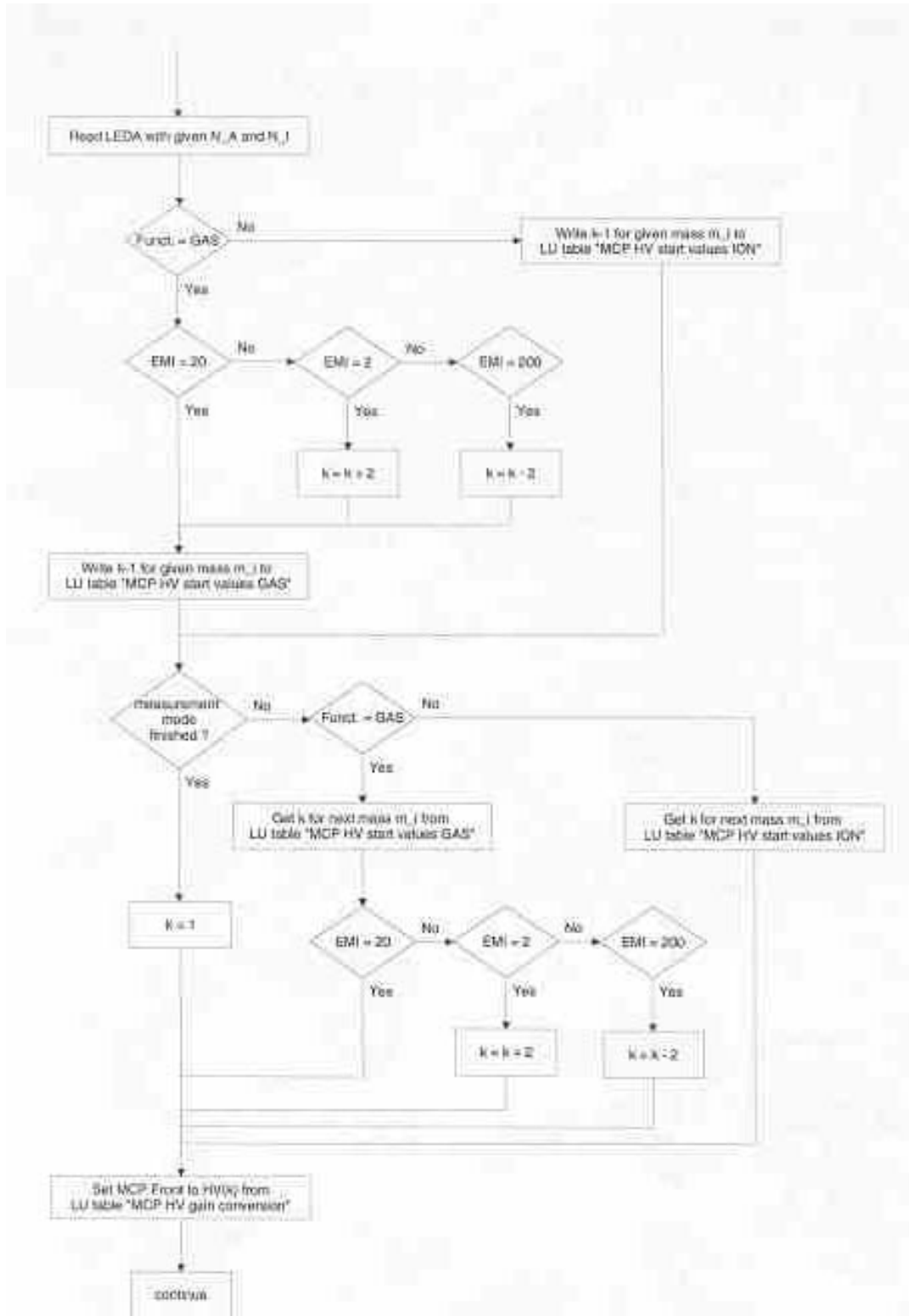

17 Appendix E: Gain adjustment algorithm for CEM

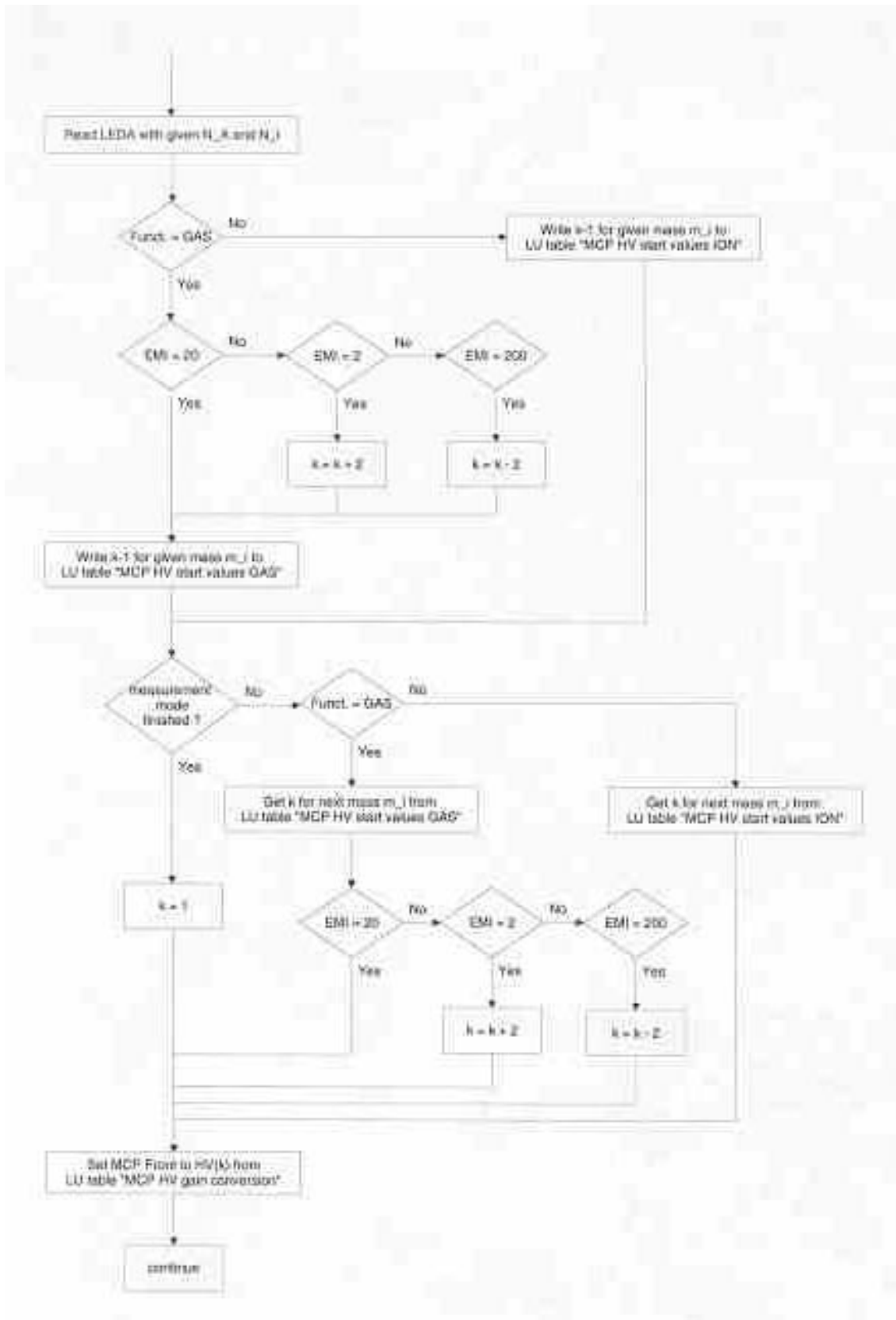

18 Appendix F: Sensitivity selection for Faraday

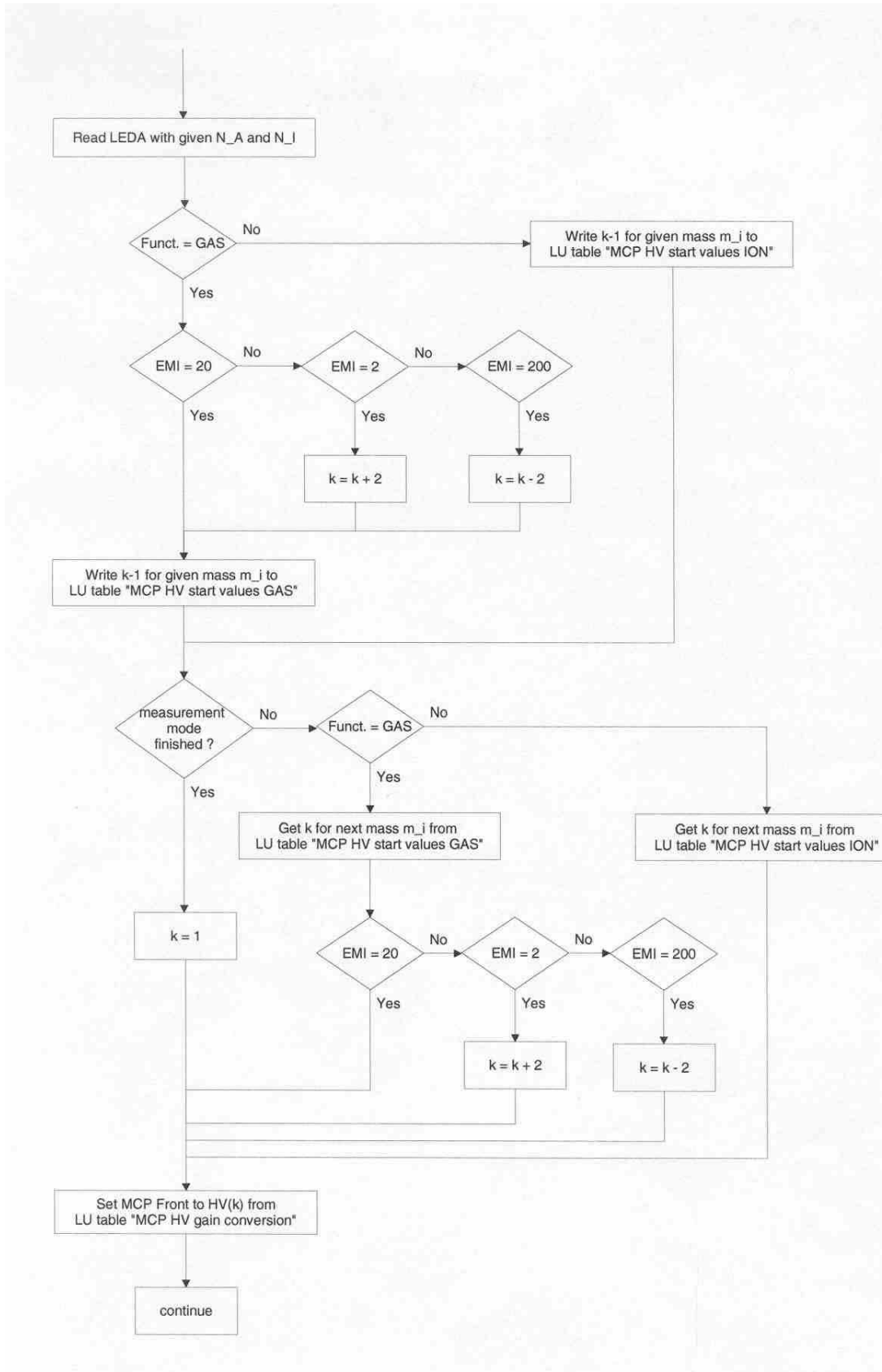

19 Appendix G: Table values for DFMS detector adjustments

<p>"MCP HV gain conversion" N_g = 16 (TBC)</p> <table border="1"> <tr><td>HV(1) (safe value)</td></tr> <tr><td>HV(2)</td></tr> <tr><td>...</td></tr> <tr><td>HV(k)</td></tr> <tr><td>HV(k+1)</td></tr> <tr><td>...</td></tr> <tr><td>HV(N_g)</td></tr> </table>	HV(1) (safe value)	HV(2)	...	HV(k)	HV(k+1)	...	HV(N_g)	<p>"MCP HV start values GAS" (TBC)</p> <table border="1"> <tr><th>m</th><th>k</th></tr> <tr><td>12</td><td>i.e.: 5</td></tr> <tr><td>13</td><td>i.e.: 4</td></tr> <tr><td>...</td><td>...</td></tr> <tr><td>139</td><td>...</td></tr> <tr><td>140</td><td>...</td></tr> </table>	m	k	12	i.e.: 5	13	i.e.: 4	139	...	140	...	<p>"CEM HV gain" N_g = 16 (TBC)</p> <table border="1"> <tr><td>HV(1)</td></tr> <tr><td>HV(2)</td></tr> <tr><td>...</td></tr> <tr><td>HV(k)</td></tr> <tr><td>HV(k+1)</td></tr> <tr><td>...</td></tr> <tr><td>HV(N_g)</td></tr> </table>	HV(1)	HV(2)	...	HV(k)	HV(k+1)	...	HV(N_g)			
HV(1) (safe value)																															
HV(2)																															
...																															
HV(k)																															
HV(k+1)																															
...																															
HV(N_g)																															
m	k																														
12	i.e.: 5																														
13	i.e.: 4																														
...	...																														
139	...																														
140	...																														
HV(1)																															
HV(2)																															
...																															
HV(k)																															
HV(k+1)																															
...																															
HV(N_g)																															
<p>"MCP linearity threshold" N_p = 10 (TBC)</p> <table border="1"> <tr><td>T(1)</td><td>p_L(1)</td></tr> <tr><td>T(2)</td><td>p_L(2)</td></tr> <tr><td>...</td><td>...</td></tr> <tr><td>T(i)</td><td>p_L(i)</td></tr> <tr><td>T(i+1)</td><td>p_L(i+1)</td></tr> <tr><td>...</td><td>...</td></tr> <tr><td>T(N_p)</td><td>p_L(N_p)</td></tr> </table>	T(1)	p_L(1)	T(2)	p_L(2)	T(i)	p_L(i)	T(i+1)	p_L(i+1)	T(N_p)	p_L(N_p)	<p>"MCP HV start values ION" (TBC)</p> <table border="1"> <tr><th>m</th><th>k</th></tr> <tr><td>12</td><td>i.e.: 5</td></tr> <tr><td>13</td><td>i.e.: 4</td></tr> <tr><td>...</td><td>...</td></tr> <tr><td>139</td><td>...</td></tr> <tr><td>140</td><td>...</td></tr> </table>	m	k	12	i.e.: 5	13	i.e.: 4	139	...	140	...	<p>"CEM settings"</p> <table border="1"> <tr><td>mode</td></tr> <tr><td>p_max_0</td></tr> <tr><td>p_max_1</td></tr> </table>	mode	p_max_0	p_max_1
T(1)	p_L(1)																														
T(2)	p_L(2)																														
...	...																														
T(i)	p_L(i)																														
T(i+1)	p_L(i+1)																														
...	...																														
T(N_p)	p_L(N_p)																														
m	k																														
12	i.e.: 5																														
13	i.e.: 4																														
...	...																														
139	...																														
140	...																														
mode																															
p_max_0																															
p_max_1																															
	<p>"MCP/LEDA settings" (TBC)</p> <table border="1"> <tr><td>p_T</td></tr> <tr><td>o_L</td></tr> </table>	p_T	o_L																												
p_T																															
o_L																															

20 Appendix F: CEM stepping

VACCI Scan (low resolution):

$$\text{stepwidth} = \frac{-\text{Mittel_vaccel}}{4000}$$

$$v_{\text{min}} = \frac{\text{Mittel_vaccel} * \text{mass}}{(\text{mass} - \sqrt{\text{mass}} * 0.035)}$$

$$v_{\text{max}} = \frac{\text{Mittel_vaccel} * \text{mass}}{(\text{mass} + \sqrt{\text{mass}} * 0.035)}$$

$$\text{stepnumber} = \frac{v_{\text{max}} - v_{\text{min}}}{\text{stepwidth}} + 1$$

$$\text{stepnumber} \cong \frac{280}{\sqrt{\text{mass}}} + 1$$

VACCI Scan (high resolution):

$$\text{stepwidth} = \frac{-\text{Mittel_vaccel}}{40000}$$

$$v_{\text{min}} = \frac{\text{Mittel_vaccel} * \text{mass}}{(\text{mass} - \sqrt{\text{mass}} * 0.006)}$$

$$v_{\text{max}} = \frac{\text{Mittel_vaccel} * \text{mass}}{(\text{mass} + \sqrt{\text{mass}} * 0.006)}$$

$$\text{stepnumber} = \frac{v_{\text{max}} - v_{\text{min}}}{\text{stepwidth}} + 1$$

$$\text{stepnumber} \cong \frac{480}{\sqrt{\text{mass}}} + 1$$

The stepping with index k is done by varying vacc in the following way:

$$\text{vaccl} = v_{\text{min}} + k * \text{stepwidth};$$

As TLL, TLR, ESS1, ESS2, RW, MP And HP are dependent on vaccel they have to be stepped accordingly.

ESA Scan (low resolution) is not meaningful

ESA Scan (high resolution):

$$esao_start = -(8.159672 \cdot 10^{-2} * Mittel_vaccel)$$

$$esai_start = (8.506995 \cdot 10^{-2} * Mittel_vaccel)$$

$$esa_ratio = -esai_start / esao_start$$

$$stepwidth_esa = 0.0020675$$

$$esao_min = -(8.159672 \cdot 10^{-2} * \frac{Mittel_vaccel * mass}{mass - \sqrt{mass} * 0.01})$$

$$esao_max = -(8.159672 \cdot 10^{-2} * \frac{Mittel_vaccel * mass}{mass + \sqrt{mass} * 0.01})$$

$$steps = \frac{esao_max - esao_min}{stepwidth_esa} = -\frac{8.159672 \cdot 10^{-2} \cdot 0.01 \cdot 2}{0.0020675} \cdot \frac{Mittel_vaccel}{\sqrt{mass}} + 1$$

$$steps(mass = 12, vaccel = -5163V) = 1178$$

$$steps(mass = 28, vaccel = -2212V) = 331$$

$$steps(mass = 100, vaccel = -618V) = 50$$

The stepping with index k is done in the following way:

$$esao = esao_min - k * 0.0020675$$

$$esai = esai_start - ((steps - 1) / 2 - k) * 0.0020675 * esa_ratio$$

21 Appendix G: Cover operation

The cover of DFMS has 1240 motor steps which cover 190 degrees of cover opening. The absolute position for the cover fully open (in the open end switch) is 0, the absolute position for the cover closed (in the closed end switch) is 160. Whenever a completely new SW is uploaded to the DPU these absolute positions have to be calibrated again. This is done with the reset cover command which puts the cover to the complete open position (absolute position 0). The open angle (measured from the closed position) of the cover can be calculated by the formula

$$\text{Angle} = 190 - 1.188 \cdot \text{absolute Position}$$

To move the cover by x degrees one has to command either the relative position (in motor steps) and the direction or the absolute position

$$\text{No. of motor steps} = 7x$$

22 Appendix H: Some useful relations

22.1 Mass dispersion on MCP „low resolution“

$$\Delta x = 25 \mu\text{m} * 512 \text{ Pixel} = 12.8\text{mm}$$

$$\text{Dispersion } D = 1.24 \cdot 10^5$$

$$\Delta x = D \frac{\Delta m}{m}$$

$$\Delta m / \text{Pixel} = \frac{\Delta x}{D} m$$

Center Mass	No. of Pixels to next mass (m+/-1)	$\Delta m / \text{Pixel}$
12	413.44	0.0024
16	310.00	0.0032
20	248.00	0.0040
28	177.14	0.0056
32	155.00	0.0065
44	112.73	0.0089
84	59.05	0.0169
130	38.15	0.0262

22.2 Gain Steps

FM

Gain step	Front-Back Voltage (Volts)	Gain _{MCP A}	Gain _{MCP B}	Front-Back Voltage (Volts)	Gain _{CEM}
1	-1300	4.94E-02	4.91E-02	-1100	7.84E+04
2	-1342	2.62E-01	2.64E-01	-1130	1.16E+05
3	-1382	1.16E+00	1.17E+00	-1165	1.83E+05
4	-1425	5.11E+00	5.16E+00	-1205	3.00E+05
5	-1468	2.02E+01	2.03E+01	-1245	4.83E+05
6	-1514	7.82E+01	7.79E+01	-1290	8.06E+05
7	-1562	2.84E+02	2.79E+02	-1340	1.38E+06
8	-1612	9.64E+02	9.31E+02	-1395	2.41E+06
9	-1665	3.09E+03	2.92E+03	-1450	4.04E+06
10	-1722	9.40E+03	8.69E+03	-1510	6.79E+06
11	-1785	2.76E+04	2.49E+04	-1580	1.17E+07
12	-1855	7.73E+04	6.77E+04	-1650	1.90E+07
13	-1932	2.01E+05	1.71E+05	-1740	3.22E+07
14	-2025	5.19E+05	4.29E+05	-1860	5.63E+07
15	-2140	1.34E+06	1.07E+06	-2035	9.73E+07
16	-2300	3.97E+06	3.09E+06	-2337	1.53E+08

FS

Gain step	Front-Back Voltage (Volts)	Gain _{MCP A}	Gain _{MCP B}	Front-Back Voltage (Volts)	Gain _{CEM}
1	-900	6.93E+00	1.71E+00	-1100	7.84E+04
2	-938	9.48E+00	3.47E+00	-1130	1.16E+05
3	-975	1.46E+01	7.23E+00	-1165	1.83E+05
4	-1012	2.49E+01	1.56E+01	-1205	3.00E+05
5	-1052	4.85E+01	3.67E+01	-1245	4.83E+05
6	-1095	1.07E+02	9.35E+01	-1290	8.06E+05
7	-1138	2.48E+02	2.38E+02	-1340	1.38E+06
8	-1185	6.40E+02	6.52E+02	-1395	2.41E+06
9	-1232	1.65E+03	1.73E+03	-1450	4.04E+06
10	-1280	4.25E+03	4.48E+03	-1510	6.79E+06
11	-1328	1.04E+04	1.10E+04	-1580	1.17E+07
12	-1380	2.57E+04	2.69E+04	-1650	1.90E+07
13	-1450	7.50E+04	7.86E+04	-1740	3.22E+07
14	-1528	2.01E+05	2.16E+05	-1860	5.63E+07
15	-1630	5.30E+05	6.08E+05	-2035	9.73E+07
16	-1770	1.37E+06	1.68E+06	-2337	1.53E+08

22.3 Vaccel as a function of mass

Mass	Vaccel
12	-5080
14	-4355
16	-3810
18	-3387
20	-3048
22	-2775
28	-2177
32	-1905
44	-1385
84	-725
130	-468

22.4 Mass as a function of Vaccel

m_u : unknown mass

m_k : known mass

$vaccel_{um}$: vaccel commanded for spectrum with unknown mass

$vaccel_{km}$: vaccel commanded for spectrum with known mass

T_{uk} : Temperature (Magnet) at which the unknown mass was measured

T_k : Temperature (Magnet) at which the known mass was measured

Δx : number of pixels between the two peaks

a) MCP

$$m_u = \frac{m_k \text{vaccel}_{km}}{\text{vaccel}_{um} (1 + \Delta x \cdot \frac{25}{1.24 \cdot 10^5} \cdot \text{zoomfactor})} = \frac{m_k \text{vaccel}_k}{\text{vaccel}_{um} (1 + 2.016 \cdot 10^{-4} \Delta x / \text{zoomfactor})} \cdot \text{Tempkorr}$$

$$\text{Tempkorr} = \frac{0.127 - 9.24 \cdot 10^{-5} (T_{uk} - 22)}{0.127 - 9.24 \cdot 10^{-5} (T_k - 22)}$$

b) CEM

$$m_u = \frac{m_k \text{vaccel}_k}{\text{vaccel}_{um}} \cdot \text{Tempkorr} = \frac{54424}{\text{vaccel}_{um}} \text{Tempkorr}$$

$$\text{Tempkorr} = \frac{0.127 - 9.24 \cdot 10^{-5} (T_{uk} - 22)}{0.127}$$

$T_{uk} (^\circ\text{C}); T_k=22^\circ\text{C}$	Tempkorr
-20	1.032
-10	1.023
0	1.016
10	1.009
30	0.994

22.5 Get a feeling for the partial pressure of a species

In order to compute the partial pressure or the density of a gas it has to be known which gas it is, how it fragments, what the specific detector efficiency is and so on. This can only be done with a careful data analysis. The formulas given here are just a rule of the thumb in order to get a feeling for the pressures (densities) involved.

Low resolution MCP:

Assumptions:

Sensitivity=1e-2 mbar⁻¹ for rows A and B

Gain=0.44e^{0.93Gainstep}

Yield Factor=1

$$p(\text{mbar}) = \frac{\sum \text{ADCcounts}(A + B) \cdot 8.8 \cdot 10^{-7}}{e^{0.93 \cdot \text{Gainstep}} * I_e (\mu\text{A}) \cdot \text{Int.time}(s)}$$

$$\sum \text{ADCcounts}(A + B) = 1.14 \cdot 10^6 p(\text{mbar}) e^{0.93 \cdot \text{Gainstep}} I_e (\mu\text{A}) \cdot \text{Int.time}(s)$$

High resolution MCP

Assumptions:

Sensitivity=1e-3 mbar⁻¹ for rows A and B

Gain=0.44e^{0.93Gainstep}
Yield Factor=1

$$p(\text{mbar}) = \frac{\sum \text{ADCcounts}(A + B) \cdot 8.8 \cdot 10^{-6}}{e^{0.93 \cdot \text{Gainstep}} * I_e(\mu\text{A}) \cdot \text{Int.time}(s)}$$

$$\sum \text{ADCcounts}(A + B) = 1.14 \cdot 10^5 p(\text{mbar}) e^{0.93 \cdot \text{Gainstep}} I_e(\mu\text{A}) \cdot \text{Int.time}(s)$$

Low resolution CEM:

Assumptions:
Sensitivity=6e-2 mbar⁻¹
Gain=39660e^{0.516Gainstep}
Yield Factor=1
Corr. Factor = 1.25

a) Digital (Gain=1)

$$p(\text{mbar}) = \frac{\sum \text{countrate_under_peak} \cdot 3.3 \cdot 10^{-12}}{I_e(\mu\text{A}) \cdot \text{Int.time}}$$

$$\sum \text{counts_under_peak} = p(\text{mbar}) I_e(\mu\text{A}) \text{Int.time}(s) \cdot 3 \cdot 10^{11}$$

b) Analog

$$p(\text{mbar}) = \frac{\sum \text{counts_under_peak} \cdot 1.7 \cdot 10^{-15}}{e^{0.516 \cdot \text{gainstep}} I_e(\mu\text{A}) \cdot \text{Int.time}(s)}$$

High resolution CEM:

Assumptions:
Sensitivity=6e-3 mbar⁻¹
Gain=39660e^{0.516Gainstep}
Yield Factor=1
Corr. Factor = 0.125

a) Digital (Gain=1)

$$p(\text{mbar}) = \frac{\sum \text{countrate_under_peak} \cdot 3.3 \cdot 10^{-12}}{I_e(\mu\text{A}) \cdot \text{Int.time}(s)}$$

$$\sum \text{counts_under_peak} = p(\text{mbar}) I_e(\mu\text{A}) \text{Int.time}(s) \cdot 3 \cdot 10^{11}$$

b) Analog

$$p(\text{mbar}) = \frac{\sum \text{counts_under_peak} \cdot 1.7 \cdot 10^{-15}}{e^{0.516 \cdot \text{gainstep}} I_e(\mu\text{A}) \cdot \text{Int.time}(s)}$$

Low resolution Faraday:

Assumptions:

Sensitivity=1.5e-1 mbar⁻¹

Yield Factor=1

$$p(\text{mbar}) = \frac{\text{max_el_output} \cdot 2.2 \cdot 10^{-8}}{I_e(\mu\text{A}) \cdot \text{Int.time}}$$

$$\text{max_el_output} = p(\text{mbar}) I_e(\mu\text{A}) \text{Int.time}(s) \cdot 4.5 \cdot 10^7$$

High resolution Faraday:

Assumptions:

Sensitivity=1.6e-2 mbar⁻¹

Yield Factor=1

$$p(\text{mbar}) = \frac{\text{max_el_output} \cdot 2.1 \cdot 10^{-7}}{I_e(\mu\text{A}) \cdot \text{Int.time}}$$

$$\text{max_el_output} = p(\text{mbar}) I_e(\mu\text{A}) \text{Int.time}(s) \cdot 4.8 \cdot 10^6$$

23 Appendix I: Data Analysis Procedure (taken from RD3)

To determine the gas detection efficiency (instrument sensitivity), the fragmentation patterns for a given gas (relative ion concentrations) or isotopic ratios, two main quantities are needed. The first quantity needed is the ion current, I_i , determined from the ion mass/charge peak in the calibration data. The second quantity needed is the electron current, I_e , set by the ion source current. In the calibration, this quantity is pre-determined by the ion source and filament settings. Finally, for the instrument sensitivity a third quantity is needed: the gas pressure, p , which is computed from the pressure measured during the calibration. The measured pressure is obtained from an ion gauge at the input to the mass spectrometer. The following equation determines the absolute gas detection efficiency (sensitivity), S_j and the fragmentation patterns for a given gas, Q_{ij} , where (i) is the ion species, and (j) denotes the gas:

$$I_i (\mu\text{A}) = I_e (\mu\text{A}) S_j (\text{mbar}^{-1}) Q_{ij} p_j (\text{mbar})$$

For a given gas, the matrix, Q_{ij} , becomes a vector and the pressure, p_j , becomes a scalar. In the above equation, the electron current I_e , and gas pressure p_j , are pre-determined by the calibration run settings. The primary computation from the calibration file is the determination of the ion current, I_i , which depends on the count rate and the gain applied to the detector.

For practical reasons, most of the time the so-called main peak sensitivity is used instead of the absolute gas sensitivity. In this case the detection efficiency S_{main} for the main mass/charge peak of a given gas has to be determined:

$$I_{\text{main}} (\mu\text{A}) = I_e (\mu\text{A}) S_{\text{main}} (\text{mbar}^{-1}) p (\text{mbar})$$

The important quantity needed for the calculation of the main peak sensitivity is the ion current I_{main} , determined from the main ion mass/charge peak in the calibration data. The electron current I_e , and the gas pressure p are determined as described above.

For the fragmentation pattern of a specific gas or the isotopic relations the ratio between the corresponding ion currents is calculated and given in percent. For example, as part of the CO_2 fragmentation pattern we get the ratio between the CO current and the CO_2 current:

$$\text{Fragmentation pattern CO/CO}_2 = I_{\text{CO}} / I_{\text{CO}_2} * 100 (\%).$$

23.1 Computing the Ion Current

The computation of the ion current depends on the detector used and the resolution applied. In general, the total counts under the ion peak minus the background determine the input to the ion current calculation. However, the calculation of the total counts depends on the detector used. The table below shows how the “total counts” are determined for each detector and resolution applied.

Detector	Process for determining the “total counts”
MCP - high resolution	Compute the total number of ADC counts minus offset under the mass/charge peak for a given ion and for each MCP-LEDA row by using the appropriate relative pixel gain correction. Add the results of both rows by using the individual gain curve for each row.
- low resolution	Compute the total number of ADC counts minus offset under the mass/charge peak for a given ion and for each MCP-LEDA row by using the appropriate relative pixel gain correction. Add the results of both rows by using the individual gain curve for each row.
CEM - high resolution	Compute the total number of counts (total current) minus offset under the fitted mass/charge peak for a given ion and correct this result by the ratio of the width of a mass step to the slit width (and the appropriate gain curve).

- low resolution	Compute the total number of counts (total current) minus offset under the fitted mass/charge peak for a given ion and correct this result by the ratio of the width of a mass step to the slit width (and the appropriate gain curve).
FAR - high resolution	Compute the maximum current minus offset for the mass/charge peak for a given ion.
- low resolution	Compute the maximum current minus offset for the fitted mass/charge peak for a given ion.

Figure 1 shows a comparison of two low-resolution MCP spectra with a background subtraction on the one hand and an offset subtraction on the other hand. In the first case a background spectrum has been measured by switching the ion beam off. Afterwards it has been subtracted from the actual spectrum. In the second case a constant offset has been calculated from a detector region where there are no ions assumed to hit the detector (in this case pixel 1 to 100 and 500 to 512).

Figure 2 shows for the same comparison the whole mass peak in a logarithmic scale. From both figures it appears justified to subtract a constant offset instead of measuring a spectrum without any ions directed to the detector.

Figure 1: Comparison of two low-resolution MCP spectra with either a background or an offset subtraction. In the first case a background has been measured by switching the ion beam off. In the second case a constant offset has been calculated from a detector region where no ion beam is assumed (in this case pixel 1 to 100 and 500 to 512).

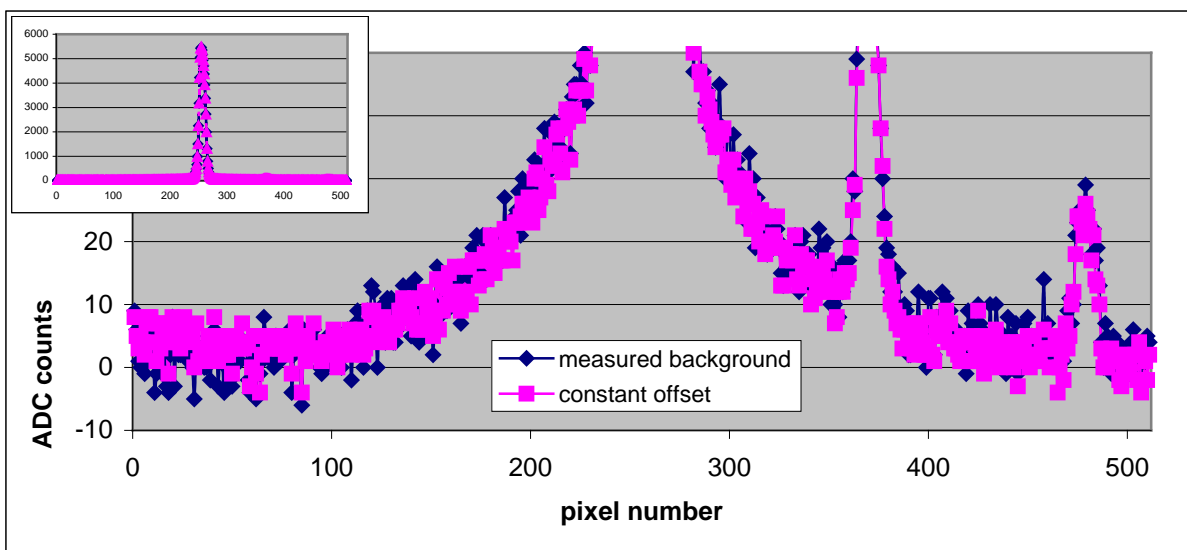
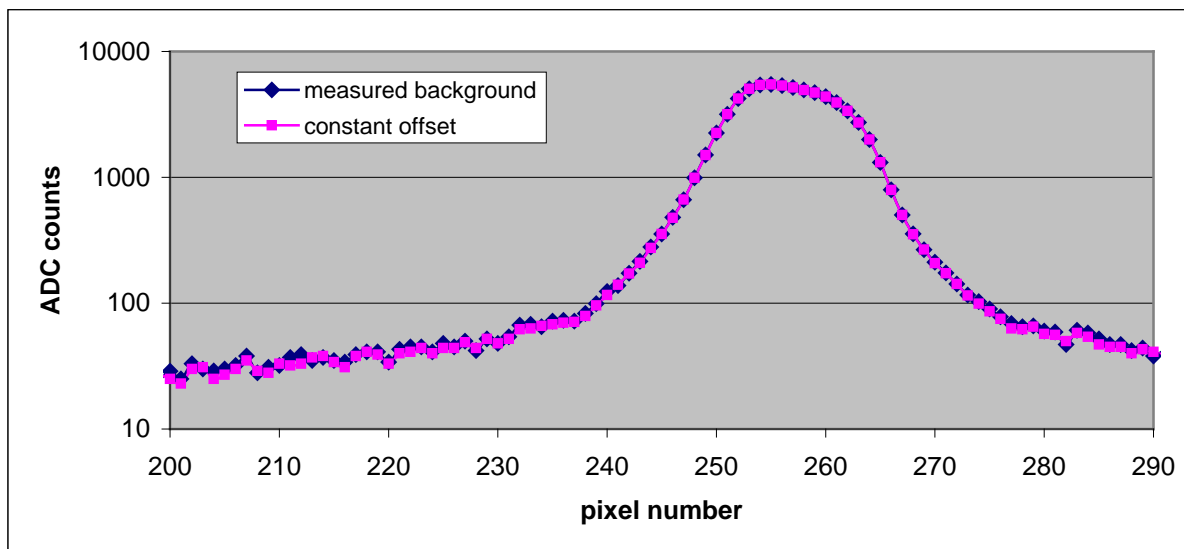

Figure 2: Same comparison as in Figure 1. The whole mass peak is shown in a logarithmic scale.



The reason why a different process is used to determine the ion current for each detector has to do with the detection process. For the MCP, it is clear that the entire mass peak falls on the MCP, so that the total count rate under the peak determines the total ion current accumulated by the detector. For the CEM at low resolution, the slit in front of the detector is narrower than the mass/charge peak width. Furthermore, the step size has to be set in relation to the slit width. Therefore, the total count rate is calculated from the sum over the mass/charge peak, corrected by the ratio of the step size to the slit width. For the CEM at high resolution, the slit in front of the detector is wider than the mass/charge peak width, so the total count rate is given by the maximum peak count rate. For the Faraday cup, the slit in front of the detector is much wider than the beam width at both high and low resolution. Therefore the total count rate is determined by the peak count rate as in the CEM – high-resolution mode.

In addition to these differences, some caution needs to be applied to the manual computation of the total count rate for each detector. These cautions are listed in the following table.

Detector	Caution
MCP	There could be bad pixels on the MCP (one bad pixel pair for FS model), which should be taken into account in the count rate computation. The mass/charge peak is maybe not exactly centered on the MCP. More than one mass peak can be detected on the MCP at one time.
CEM	The first two values in a scan can contain very high counts due to changes in the acceleration voltage. The mass/charge peak is not necessarily centered in the mass/charge scan.
FAR	The first two values in a scan can contain very high counts due to changes in the acceleration voltage.

The mass/charge peak is not necessarily centered in the mass/charge scan.

Given the total - background count rate determined by the above procedure, the computation of the ion current for each of the detectors is given by the following equations (cal. gas = calibration gas, res. gas = residual gas):

MCP:

$$I_i(A) = \text{YieldFactor}_{\text{MCP}} \cdot 3,9 \cdot 10^{-15} \cdot \left(\frac{\Sigma(\text{ADC counts row A cal. gas})}{\text{Gain}_{\text{MCP row A (cal. gas)}}} - \frac{\Sigma(\text{ADC counts row A res. gas})}{\text{Gain}_{\text{MCP row A (res. gas)}}} \right) + \left(\frac{\Sigma(\text{ADC counts row B cal. gas})}{\text{Gain}_{\text{MCP row B (cal. gas)}}} - \frac{\Sigma(\text{ADC counts row B res. gas})}{\text{Gain}_{\text{MCP row B (res. gas)}}} \right)$$

In these formulas as well as in the evaluation of this calibration campaign the relative gain MCP gain corrections have not been taken into account. For each calibration gas a specific yield factor has to be used, in order to take into account that the MCP gain values have been determined with N₂ ions with 3keV energy. The following table gives some examples of used yield factors [RD4]:

Ion	Energy (keV)	Yield Factor
CO ₂ ⁺	1.4	2.83
C ⁺	5.1	0.72
O ⁺	3.8	0.93
CO ⁺	2.2	1.64

CEM digital low resolution:

$$I_i(A) = \text{Corr.Factor}_{\text{CEM,low}} \cdot 1,6 \cdot 10^{-19} (\Sigma(\text{count rate cal. gas}) - \Sigma(\text{count rate res. gas}))$$

CEM digital high resolution:

$$I_i(A) = \text{Corr.Factor}_{\text{CEM,high}} \cdot 1,6 \cdot 10^{-19} (\Sigma(\text{count rate cal. gas}) - \Sigma(\text{count rate res. gas}))$$

CEM analog low resolution:

$$I_i(A) = \text{Corr.Factor}_{\text{CEM,low}} \cdot \text{YieldFactor}_{\text{CEM}} \cdot \frac{(\Sigma(\text{current cal. gas}) - \Sigma(\text{current res. gas}))}{\text{Gain}_{\text{CEM}}}$$

CEM analog high resolution:

$$I_i(A) = \text{Corr.Factor}_{\text{CEM,high}} \cdot \text{Yield Factor}_{\text{CEM}} \cdot \frac{(\sum(\text{current cal. gas}) - \sum(\text{current res. gas}))}{\text{Gain}_{\text{CEM}}}$$

The CEM Correction Factor is given by the ratio of the step size to the slit width: $(D \cdot dm/m)/s$, whereas D denotes the mass dispersion of the sensor and s the slit width in front of the CEM (25 μ m). dm/m is the ratio of a step during the mass scan in mass units to the measured mass. There are different step sizes used in the low- and high-resolution mode (see section 1.4).

Note that there is no gain correction factor for the CEM digital count rate. This assumes that in the digital mode, where individual ions are counted, the applied voltage over the channeltron ensures, that the channeltron is operated in the plateau range of the gain curve. This assumption is justified, as the highest gain for the CEM has been used during the whole calibration procedure ($\text{Gain}_{\text{CEM}} = 2.12 \cdot 10^8$).

In the analog mode a gain correction factor is used and additionally, for each calibration gas a specific yield factor has to be applied, in order to take into account that the CEM gain values have been determined with N_2 ions with 3keV energy. The following table gives some examples of used yield factors [RD4]:

Ion	Energy (keV)	Yield Factor
CO ₂ ⁺	1.4	0.87
C ⁺	5.1	0.82
O ⁺	3.8	0.95
CO ⁺	2.2	0.87

FAR:

$$I_i(A) = 3,33 \cdot 10^{-15} (\text{Max El.meter output cal. gas} - \text{Max El.meter output res. gas})$$

Note that the stated conversion factor for the Electrometer output (mVolt to Ampere) is only valid for the used high sensitivity range of the elctrometer.

23.2 Computing the Gain

The gain in the above equations of the ion current is a function of the detector voltage applied and the detector used. These gain curves have been determined during the FS-Detector Calibration and are reported in [RD3]. The following equations are the result of fits to the gain curve as a function of the Front-Back voltages (F-B) applied to the detector.

$$\text{MCP row A: Gain}_{\text{MCP}} = 10^{(55.40926 + 0.17767 \cdot (F-B) + 2.02803E-4 \cdot (F-B)^2 + 9.54235E-8 \cdot (F-B)^3 + 1.61982E-11 \cdot (F-B)^4)}$$

$$\text{MCP row B: Gain}_{\text{MCP}} = 10^{(21.18323 + 0.08311 \cdot (F-B) + 1.0563E-4 \cdot (F-B)^2 + 5.14151E-8 \cdot (F-B)^3 + 8.79538E-12 \cdot (F-B)^4)}$$

$$\text{CEM: Gain}_{\text{CEM}} = 10^{(-2.37131 - 0.00479 \cdot (F-B) + 4.7381E-6 \cdot (F-B)^2 + 3.45658E-9 \cdot (F-B)^3 + 5.9012E-13 \cdot (F-B)^4)}$$

For the MCP, the Front and Back voltages are measured and provided in the instrument housekeeping. In this calibration campaign only negative MCP Back voltages (–200V) are used. For the CEM, only the Front voltage is measured. The Back voltage is fixed to –63V. During this calibration campaign all Front and Back voltages have been manually commanded according to the below given table and not by an automatic gain control (AGC) algorithm.

The following table lists some typical numbers for the Front - Back voltages and the resulting MCP (row A and B) and CEM Gains.

Front-Back Voltage (Volts)	Gain_{MCP A}	Front-Back Voltage (Volts)	Gain_{MCP B}	Front-Back Voltage (Volts)	Gain_{CEM}
-900	6.93E+00	-900	1.71E+00	-1100	7.84E+04
-980	1.56E+01	-950	4.29E+00	-1200	2.82E+05
-1030	3.51E+01	-995	1.08E+01	-1300	9.00E+05
-1075	7.89E+01	-1040	2.70E+01	-1400	2.53E+06
-1120	1.78E+02	-1080	6.79E+01	-1500	6.25E+06
-1160	4.00E+02	-1123	1.70E+02	-1600	1.35E+07
-1200	8.99E+02	-1165	4.28E+02	-1700	2.58E+07
-1240	2.02E+03	-1208	1.07E+03	-1800	4.35E+07
-1280	4.55E+03	-1253	2.69E+03	-1900	6.55E+07
-1323	1.02E+04	-1300	6.76E+03	-2000	8.92E+07
-1370	2.30E+04	-1350	1.70E+04	-2100	1.12E+08
-1425	5.18E+04	-1408	4.26E+04	-2200	1.31E+08
-1482	1.17E+05	-1470	1.07E+05	-2300	1.47E+08
-1550	2.62E+05	-1545	2.68E+05	-2400	1.63E+08
-1635	5.91E+05	-1640	6.74E+05	-2500	1.82E+08
-1770	1.33E+06	-1770	1.69E+06	-2600	2.12E+08