

**FLUXGATE MAGNETOMETER
CALIBRATION
FOR**

R O S E T T A

RO-IGM-TR-0002

Issue: 2 Revision: 2

October 10, 2001

**Report on the
Flight Unit (FM)
and
Flight Spare Unit (FS)
Calibration**

Matthias Rahm
e-mail: elgematthias.rahm@t-online.de

Dr. Ingo Richter
e-mail: i.richter@tu-bs.de

Institut für Geophysik und Meteorologie
Technische Universität Braunschweig
Mendelssohnstraße 3, 38106 Braunschweig
Germany

R O S E T T A	Document: RO-IGM-TR-0002 Issue: 2 Revision: 2
IGM Institut für Geophysik und Meteorologie Technische Universität Braunschweig	Date: October 10, 2001 Page: 2

R O S E T T A		Document: RO-IGM-TR-0002
		Issue: 2
		Revision: 2
IGM	Institut für Geophysik und Meteorologie	Date: October 10, 2001
	Technische Universität Braunschweig	Page: I

Contents

1	Introduction	1
1.1	Related Documents	2
1.2	Part Identification	3
1.3	Key Personnel	3
2	Monday March 19, 2001	5
2.1	Pre Calibration Residual Field Adjustment	5
2.2	Calibration Setup	6
2.2.1	Hardware Setup	6
2.2.2	Software Setup	7
2.3	Offset Measurements — DPU: FM, Sensors FM-IB & FM-OB	7
2.3.1	Data	8
2.4	Linearity, Sensitivity and Cross Talk — DPU: FM, Sensors FM-IB & FM-OB	9
2.4.1	Data	9
2.5	Overview Plots: System Performance, Temperatures and Earthfield Variations.	10
3	Tuesday March 20, 2001	13
3.1	Linearity, Sensitivity and Cross Talk — DPU: FM, Sensors FM-IB & FM-OB — Continued	13
3.1.1	Data	13
3.2	Overview Plots: System Performance, Temperatures and Earthfield Variations.	14
4	Wednesday March 21, 2001	17
4.1	Optical Alignment System	17
4.2	FGM-OB: Optical Alignment	17
4.3	Linearity, Sensitivity and Cross Talk — DPU: FM, Sensors: FM-OB	21
4.3.1	Data	21
4.4	Overview Plots: System Performance, Temperatures and Earthfield Variations.	22
5	Thursday March 22, 2001	25
5.1	Linearity, Sensitivity and Cross Talk — DPU: FM, Sensors: FM-OB — Continued	25
5.1.1	Data	25
5.2	Linearity, Sensitivity and Cross Talk — DPU: FM, Sensors: FM-IB	25
5.2.1	Data	26
5.3	Overview Plots: System Performance, Temperatures and Earthfield Variations.	27
6	Friday March 23, 2001	30
6.1	Linearity, Sensitivity and Cross Talk — DPU: FM, Sensors: FM-IB — Continued	30
6.1.1	Data	30
6.2	Setup for the Temperature Calibration	30
6.3	Temperature Cycle, Linearities, FM Sensors	31
6.3.1	Data	32
6.4	Temperature Calibration, Cooling Cycle, FM Sensors	32
6.4.1	Data	32
6.5	Overview Plots: System Performance, Temperatures and Earthfield Variations.	33
7	Saturday March 24, 2001	37
7.1	Temperature Calibration, Cooling Cycle, FM Sensors, Continued	37
7.1.1	Data	37
7.2	Overview Plots: System Performance, Temperatures and Earthfield Variations.	38
8	Sunday March 25, 2001	42
8.1	Temperature Calibration, Heating Cycle, FM Sensors	42

R O S E T T A	Document: RO-IGM-TR-0002
IGM Institut für Geophysik und Meteorologie Technische Universität Braunschweig	Issue: 2
	Revision: 2
	Date: October 10, 2001
	Page: II

8.1.1	Data	42
8.2	Overview Plots: System Performance, Temperatures and Earthfield Variations. . .	43
9	Monday March 26, 2001	47
9.1	Temperature Calibration, Heating Cycle, FM Sensors, Continued	47
9.1.1	Data	47
9.2	Overview Plots: System Performance, Temperatures and Earthfield Variations. . .	48
10	Tuesday March 27, 2001	52
10.1	Temperature Calibration, Heating Cycle, FM Sensors, Continued	52
10.1.1	Data	52
10.2	Overview Plots: System Performance, Temperatures and Earthfield Variations. . .	53
11	Wednesday March 28, 2001	57
11.1	Temperature Calibration, Heating Cycle, FM Sensors, Continued	57
11.1.1	Data	57
11.2	Temperature Cycle, Linearities, FM Sensors	57
11.2.1	Data	57
11.3	Earth Field Variation Check. DPU: FM, Sensors: FM-IB & FM-OB	58
11.3.1	Data	58
11.4	Overview Plots: System Performance, Temperatures and Earthfield Variations. . .	59
12	Thursday March 29, 2001	62
12.1	Earth Field Variation Check. DPU: FM, Sensors: FM-IB & FM-OB, Continued . .	62
12.1.1	Data	62
12.2	Overview Plots: System Performance, Temperatures and Earthfield Variations. . .	64
13	Thursday April 5, 2001	68
13.1	Offset Measurements — DPU: FS, Sensors FM-IB & FM-OB	68
13.1.1	Data	68
13.2	Digital Frequency Response — DPU: FS, Sensors FM-IB & FM-OB	69
13.2.1	Data	70
13.3	Linearity, Sensitivity and Cross Talk — DPU: FS, Sensors: FM-OB	70
13.3.1	Data	70
13.4	Overview Plots: System Performance, Temperatures and Earthfield Variations. . .	71
14	Friday April 6, 2001	75
14.1	Linearity, Sensitivity and Cross Talk — DPU: FS, Sensors: FM-OB, Continued . .	75
14.1.1	Data	75
14.2	Linearity, Sensitivity and Cross Talk — DPU: FS, Sensors: FM-IB	75
14.2.1	Data	76
14.3	Overview Plots: System Performance, Temperatures and Earthfield Variations. . .	77
15	Friday April 20, 2001	81
15.1	Digital Frequency Response — DPU: FM, Sensors FM-IB & FM-OB	81
15.1.1	Data	82
15.2	Supply Voltage Dependence — DPU: FM, Sensors FM-IB & FM-OB	82
15.2.1	Data	83
15.2.2	Results	83
15.3	Linearity, Sensitivity and Cross Talk — DPU: FM, Sensors: FS-IB	87
15.3.1	Data	87
15.4	Overview Plots: System Performance, Temperatures and Earthfield Variations. . .	88
16	Saturday April 21, 2001	92
16.1	Linearity, Sensitivity and Cross Talk — DPU: FM, Sensors: FS-IB, Continued . . .	92

R O S E T T A		Document: RO-IGM-TR-0002
IGM Institut für Geophysik und Meteorologie Technische Universität Braunschweig		Issue: 2
		Revision: 2
		Date: October 10, 2001
		Page: III

16.1.1	Data	92
16.2	Linearity, Sensitivity and Cross Talk — DPU: FM, Sensors: FS-OB	92
16.2.1	Data	93
16.3	Overview Plots: System Performance, Temperatures and Earthfield Variations. . .	94
17	Sunday April 22, 2001	98
17.1	Linearity, Sensitivity and Cross Talk — DPU: FM, Sensors: FS-OB,Continued . .	98
17.1.1	Data	98
17.2	Earth Field Variation Check. DPU: FM, Sensors: FS-IB & FS-OB	98
17.2.1	Data	99
17.3	Linearity, Sensitivity and Cross Talk — DPU: FM, Sensors: FS-OB,Continued . .	101
17.3.1	Data	101
17.4	Overview Plots: System Performance, Temperatures and Earthfield Variations. . .	102
18	Monday April 23, 2001	106
18.1	Linearity, Sensitivity and Cross Talk — DPU: FM, Sensors: FS-OB,Continued . .	106
18.1.1	Data	106
18.2	Digital Frequency Response — DPU: FM, Sensors FS-IB & FS-OB	106
18.2.1	Data	107
18.3	Offset Measurements — DPU: FM, Sensors FS-IB & FS-OB	107
18.3.1	Data	107
18.4	Linearity, Sensitivity and Cross Talk — DPU: FS, Sensors: FS-IB	108
18.4.1	Data	109
18.5	Overview Plots: System Performance, Temperatures and Earthfield Variations. . .	110
19	Tuesday April 24, 2001	114
19.1	Linearity, Sensitivity and Cross Talk — DPU: FS, Sensors: FS-IB,Continued . . .	114
19.1.1	Data	114
19.2	Linearity, Sensitivity and Cross Talk — DPU: FS, Sensors: FS-OB	114
19.2.1	Data	115
19.3	Overview Plots: System Performance, Temperatures and Earthfield Variations. . .	116
20	Wednesday April 25, 2001	120
20.1	Linearity, Sensitivity and Cross Talk — DPU: FS, Sensors: FS-OB, Continued . .	120
20.1.1	Data	120
20.2	Digital Frequency Response — DPU: FS, Sensors FS-IB & FS-OB, Failed	120
20.2.1	Data	121
20.3	Offset Measurements — DPU: FS, Sensors FS-IB & FS-OB	121
20.3.1	Data	121
20.4	Digital Frequency Response — DPU: FS, Sensors FS-IB & FS-OB, Repetition . .	122
20.4.1	Data	123
20.5	Overview Plots: System Performance, Temperatures and Earthfield Variations. . .	124
21	Thursday April 26, 2001	128
21.1	Digital Frequency Response — DPU: FS, Sensors FS-IB & FS-OB, Repetition . .	128
21.1.1	Data	128
21.2	Supply Voltage Dependence — DPU: FS, Sensors FS-IB & FS-OB	128
21.2.1	Data	129
21.2.2	Results	129
21.3	Setup for the Temperature Calibration	133
21.4	Temperature Cycle, Linearities, FS Sensors	134
21.4.1	Data	134
21.5	Temperature Calibration, Cooling Cycle, FS Sensors	135
21.5.1	Data	135
21.6	Overview Plots: System Performance, Temperatures and Earthfield Variations. . .	136

R O S E T T A		Document: RO-IGM-TR-0002
		Issue: 2
		Revision: 2
IGM	Institut für Geophysik und Meteorologie	Date: October 10, 2001
	Technische Universität Braunschweig	Page: IV

22 Friday April 27, 2001	140
22.1 Temperature Calibration, Cooling Cycle, FS Sensors, Continued	140
22.1.1 Data	140
22.2 Overview Plots: System Performance, Temperatures and Earthfield Variations. . .	141
23 Saturday April 28, 2001	145
23.1 Temperature Calibration, Heating Cycle, FS Sensors	145
23.1.1 Data	145
23.2 Overview Plots: System Performance, Temperatures and Earthfield Variations. . .	146
24 Sunday April 29, 2001	151
24.1 Temperature Calibration, Heating Cycle, FS Sensors, Continued	151
24.1.1 Data	151
24.2 Overview Plots: System Performance, Temperatures and Earthfield Variations. . .	152
25 Monday April 30, 2001	156
25.1 Temperature Calibration, Heating Cycle, FS Sensors, Continued	156
25.1.1 Data	156
25.2 Overview Plots: System Performance, Temperatures and Earthfield Variations. . .	157
26 Tuesday May 1, 2001	161
26.1 Temperature Calibration, Heating Cycle, FS Sensors, Continued	161
26.1.1 Data	161
26.2 Temperature Cycle, Linearities, FS Sensors	161
26.2.1 Data	162
26.3 Overview Plots: System Performance, Temperatures and Earthfield Variations. . .	163
27 Wednesday May 2, 2001	167
27.1 Temperature Cycle, Linearities, FS Sensors	167
27.1.1 Data	167
27.2 Overview Plots: System Performance, Temperatures and Earthfield Variations. . .	168
28 Tuesday August 28, 2001	172
28.1 Pre Calibration Residual Field Adjustment	172
28.2 Setup for the Temperature Calibration	173
28.3 Temperature Cycle, Linearities, DPU:FS, Sensors: FS	174
28.3.1 Data	175
28.4 Temperature Calibration, Heating Cycle, DPU:FS, Sensors: FS	175
28.4.1 Data	175
28.5 Overview Plots: System Performance, Temperatures and Earthfield Variations. . .	176
29 Wednesday August 29, 2001	180
29.1 Temperature Calibration, Heating Cycle continued, DPU:FS, Sensors: FS	180
29.1.1 Data	180
29.2 Overview Plots: System Performance, Temperatures and Earthfield Variations. . .	181
30 Thursday August 30, 2001	185
30.1 Temperature Calibration, Heating Cycle continued, DPU:FS, Sensors: FS	185
30.1.1 Data	185
30.2 Temperature Calibration, Cooling Cycle, DPU:FS, Sensors: FS	186
30.2.1 Data	186
30.3 Overview Plots: System Performance, Temperatures and Earthfield Variations. . .	187
31 Friday August 31, 2001	191
31.1 Temperature Calibration, Cooling Cycle continued, DPU:FS, Sensors: FS	191
31.1.1 Data	191

R O S E T T A		Document: RO-IGM-TR-0002
IGM Institut für Geophysik und Meteorologie Technische Universität Braunschweig		Issue: 2
		Revision: 2
		Date: October 10, 2001
		Page: V

31.2 Overview Plots: System Performance, Temperatures and Earthfield Variations. . .	192
32 Saturday September 1, 2001	196
32.1 Temperature Calibration, Cooling Cycle continued, DPU:FS, Sensors: FS	196
32.1.1 Data	196
32.2 Overview Plots: System Performance, Temperatures and Earthfield Variations. . .	197
33 Sunday September 2, 2001	201
33.1 Temperature Calibration, Cooling Cycle continued, DPU:FS, Sensors: FS	201
33.1.1 Data	201
33.2 Overview Plots: System Performance, Temperatures and Earthfield Variations. . .	202
34 Monday September 3, 2001	206
34.1 Temperature Calibration, Cooling Cycle continued, DPU:FS, Sensors: FS	206
34.1.1 Data	206
34.2 Overview Plots: System Performance, Temperatures and Earthfield Variations. . .	207
35 Thursday September 6, 2001	211
35.1 Temperature Cycle, Linearities, DPU:FS, Sensors: FM	211
35.1.1 Data	211
35.2 Temperature Calibration, Cooling Cycle, DPU:FS, Sensors: FM	211
35.2.1 Data	212
35.3 Overview Plots: System Performance, Temperatures and Earthfield Variations. . .	213
36 Friday September 7, 2001	217
36.1 Temperature Calibration, Cooling Cycle continued, DPU:FS, Sensors: FM	217
36.1.1 Data	217
36.2 Overview Plots: System Performance, Temperatures and Earthfield Variations. . .	218
37 Saturday September 8, 2001	222
37.1 Temperature Calibration, Cooling Cycle continued, DPU:FS, Sensors: FM	222
37.1.1 Data	222
37.2 Overview Plots: System Performance, Temperatures and Earthfield Variations. . .	223
38 Sunday September 9, 2001	227
38.1 Temperature Calibration, Cooling Cycle continued, DPU:FS, Sensors: FM	227
38.1.1 Data	227
38.2 Overview Plots: System Performance, Temperatures and Earthfield Variations. . .	228
39 Monday September 10, 2001	232
39.1 Temperature Calibration, Cooling Cycle continued, DPU:FS, Sensors: FM	232
39.1.1 Data	232
39.2 Temperature Calibration, Heating Cycle, DPU:FS, Sensors: FM	233
39.2.1 Data	233
39.3 Overview Plots: System Performance, Temperatures and Earthfield Variations. . .	234
40 Tuesday September 11, 2001	238
40.1 Temperature Calibration, Heating Cycle continued, DPU:FS, Sensors: FM	238
40.1.1 Data	238
40.2 Overview Plots: System Performance, Temperatures and Earthfield Variations. . .	239
41 Wednesday September 12, 2001	243
41.1 Temperature Calibration, Heating Cycle continued, DPU:FS, Sensors: FM	243
41.1.1 Data	243
41.2 Overview Plots: System Performance, Temperatures and Earthfield Variations. . .	244

R O S E T T A	Document: RO-IGM-TR-0002
IGM	Issue: 2
	Revision: 2
	Date: October 10, 2001
	Page: VI
Institut für Geophysik und Meteorologie Technische Universität Braunschweig	

42 Thursday September 13, 2001	248
42.1 Temperature Calibration, Heating Cycle continued, DPU:FS, Sensors: FM	248
42.1.1 Data	248
42.2 Overview Plots: System Performance, Temperatures and Earthfield Variations. . .	249
43 The End	253
A Overview Plots	254
A.1 General Remarks	254
A.2 Remarks on Calibration Specials	257
A.2.1 System Performance, the FLD-SOL Problem	257
B Stability Measurements	258
B.1 Setup	258
B.2 Thursday March 8, 2001	259
B.2.1 Overview Plots: System Performance, Temperatures and Earthfield Variations.	259
B.3 Friday March 9, 2001	263
B.3.1 Overview Plots: System Performance, Temperatures and Earthfield Variations.	263
B.4 Saturday March 10, 2001	267
B.4.1 Overview Plots: System Performance, Temperatures and Earthfield Variations.	267
B.5 Sunday March 11, 2001	271
B.5.1 Overview Plots: System Performance, Temperatures and Earthfield Variations.	271
B.6 Monday March 12, 2001	275
B.6.1 Overview Plots: System Performance, Temperatures and Earthfield Variations.	275
B.7 Tuesday March 13, 2001	279
B.7.1 Overview Plots: System Performance, Temperatures and Earthfield Variations.	279
B.8 Wednesday March 14, 2001	283
B.8.1 Overview Plots: System Performance, Temperatures and Earthfield Variations.	283
B.9 Thursday March 15, 2001	287
B.9.1 Overview Plots: System Performance, Temperatures and Earthfield Variations.	287
B.10 Friday March 16, 2001	291
B.10.1 Overview Plots: System Performance, Temperatures and Earthfield Variations.	291
B.11 Saturday March 17, 2001	295
B.11.1 Overview Plots: System Performance, Temperatures and Earthfield Variations.	295
B.12 Sunday March 18, 2001	299
B.12.1 Overview Plots: System Performance, Temperatures and Earthfield Variations.	299
C File Info Tables	303
C.1 CD-ROM	303
C.2 01-03-08	304
C.3 01-03-09	304
C.4 01-03-10	304
C.5 01-03-11	305
C.6 01-03-12	305
C.7 01-03-13	306
C.8 01-03-14	306
C.9 01-03-15	307
C.10 01-03-16	307
C.11 01-03-17	308
C.12 01-03-18	308
C.13 01-03-19	309
C.14 01-03-20	309
C.15 01-03-21	310
C.16 01-03-22	310
C.17 01-03-23	310

R O S E T T A		Document: RO-IGM-TR-0002
		Issue: 2
		Revision: 2
IGM	Institut für Geophysik und Meteorologie	Date: October 10, 2001
	Technische Universität Braunschweig	Page: VII

C.18	01-03-24	311
C.19	01-03-25	311
C.20	01-03-26	311
C.21	01-03-27	312
C.22	01-03-28	312
C.23	01-03-29	312
C.24	01-04-05	313
C.25	01-04-06	313
C.26	01-04-20	313
C.27	01-04-21	314
C.28	01-04-22	314
C.29	01-04-23	314
C.30	01-04-24	315
C.31	01-04-25	315
C.32	01-04-26	315
C.33	01-04-27	316
C.34	01-04-28	316
C.35	01-04-29	316
C.36	01-04-30	317
C.37	01-05-01	317
C.38	01-05-02	317
C.39	01-08-28	318
C.40	01-08-29	318
C.41	01-08-30	318
C.42	01-08-31	319
C.43	01-09-01	319
C.44	01-09-02	319
C.45	01-09-03	320
C.46	01-09-06	320
C.47	01-09-07	320
C.48	01-09-08	321
C.49	01-09-09	321
C.50	01-09-10	321
C.51	01-09-11	322
C.52	01-09-12	322
C.53	01-09-13	322
D FGM Sensor Alignment Tables		323
E Temperature Measurements		325
E.1	Sensor Temperatures	325
E.2	Thermal Test Box Temperatures	327
E.3	Temperature Calibration Cycle 1, March 2001, DPU: FM, Sensors: FM	328
E.4	Temperature Calibration Cycle 2, April 2001, DPU: FS, Sensors: FS	329
E.5	Temperature Calibration Cycle 3, August 2001, DPU: FS, Sensors: FS	329
E.6	Temperature Calibration Cycle 4, August and September 2001, DPU: FS, Sensors: FS	330
E.7	Temperature Calibration Cycle 5, September 2001, DPU: FS, Sensors: FM	331
E.8	Temperature Calibration Cycle 6, September 2001, DPU: FS, Sensors: FM	332
F Images of the ROSETTA Calibration		333
F.1	Album	334
F.1.1	Images 01-03-21	334
F.1.2	Images 01-03-22	335
F.1.3	Images 01-03-23	336
F.1.4	Images 01-04-05	337

R O S E T T A		Document: RO-IGM-TR-0002
		Issue: 2
		Revision: 2
IGM	Institut für Geophysik und Meteorologie	Date: October 10, 2001
	Technische Universität Braunschweig	Page: VIII

F.1.5	Images 01-04-06	341
F.1.6	Images 01-04-20	341
F.1.7	Images 01-04-21	342
F.1.8	Images 01-04-23	343
F.1.9	Images 01-04-24	346
F.1.10	Images 01-04-25	347
F.1.11	Images 01-04-26	351
F.1.12	Images 01-08-28	352
F.1.13	Images 01-09-13	353

R O S E T T A		Document: RO-IGM-TR-0002
		Issue: 2
		Revision: 2
IGM	Institut für Geophysik und Meteorologie	Date: October 10, 2001
	Technische Universität Braunschweig	Page: 1

1 Introduction

This document describes the ROSETTA Flight Unit Calibration performed from March 19th, to May 2nd, 2001 and from August 28th to September 13th, 2000 (additional temperature cycle) at the Institute of Geophysics and Meteorology, Technical University of Braunschweig. Day by day the performed calibration steps, special tests and some handling steps are described with their conditions and the necessary support information in detail. Thus this document describes an easy way to find the data of a specific calibration task. To support the user of this document in finding a specific measurement an index to all measurements is added. In addition a complete list of data files faced to there configuration files can be found in the appendix at page 303ff.

Another interesting part of the appendix is the collection of all the coil system stability measurements prior to the calibration starting at page 258. Also in the appendix (page 325ff) helpful information of the temperature measurements during this calibration session can be found.

Finally the appendix gives an album of all the photos taken during the calibration. On page 333 a list of titles to the photos is given.

R O S E T T A		Document: RO-IGM-TR-0002
		Issue: 2
		Revision: 2
IGM	Institut für Geophysik und Meteorologie	Date: October 10, 2001
	Technische Universität Braunschweig	Page: 2

1.1 Related Documents

Some documents developed during the CLUSTER I and CLUSTER II investigations may be of help understanding the general topics also covered by this document related to ROSETTA mission. Some documents related to the calibration facility are referenced in the following table. The last CLUSTER II calibration report is mentioned for comparison. The documents are of special interest for understanding and interpreting the calibration data, as well as some documents issued for the Magnetsrode standard systems. The documents of special interest for understanding the calibration data and procedures are the following.

MR-IGM-TN-0004 MRode Software Manual & Configuration of attached hardware.	Description of the controlling software, the hardware devices and handling notes.
CL-IGM-TN-0008 Calibration Data Recording System	Description of the Data Formats, the ClusTerm program and the Utility programs for working on the CCD files.
CL-IGM-TN-0014 Methods of Analysis for Magnetometer Calibration.	Analysis methods for evaluating the various calibration measurements of the Cluster magnetometers are described in detail.
CL-IGM-TR-0440 Report on the Cluster F1 Calibration.	Calibration report.
CL-IGM-TR-0441 Results of the F1 Calibration.	Calibration analysis.
CL2-IGM-TR-0002 Report on the Cluster-II F7 Calibration.	Calibration report.
CL2-IGM-TR-0003 Results of the F7 Calibration.	Calibration analysis.
RO-IGM-TR-0003 Results of the ROSETTA Calibration.	Calibration analysis.
MR-IGM-TN-0005	Manual for the Thermal Test Box.
RO-IWF-TR-0001 (by IWF Graz)	ROSETTA sample rate and frequency response analysis.

R O S E T T A		Document: RO-IGM-TR-0002
		Issue: 2
		Revision: 2
IGM	Institut für Geophysik und Meteorologie	Date: October 10, 2001
	Technische Universität Braunschweig	Page: 3

1.2 Part Identification

The items listed below are combined to build up two complete FGM systems. These parts have been checked and calibrated in different configurations to ensure that, in case of a later on recognized failure, all parameters are known. Therefore, the FM sensors have been calibrated with the FM and FS DPU as well as the FS sensors have been checked with both DPUs.

Item	PTI	Serial	Cube Mirror
DPU	FM	FGM electronics FM	
FGM-OB	FM-MAG #1	FGM OB sensor FM	OB
FGM-IB	FM-MAG #2	FGM IB sensor FM	IB
DPU	FS	FGM electronics FS	
FGM-OB	FS-MAG #1	FGM OB sensor FS	OB
FGM-IB	FS-MAG #2	FGM IB sensor FS	IB

1.3 Key Personnel

IGM-Team:	Falko Kuhnke	Experiment Setup
	Carsten Othmer	DC-Analysis of the data.
	Matthias Rahm	Documentation: Overview Plots, ...
	Ingo Richter	Operating the MCF-System, the Calibration Data Recording System and the ROSETTA FGM during the whole calibration. Documentation, DC & Special Analysis.
IWF-Team:	Hans Eichelberger	AC-Analysis of the data.

R O S E T T A		Document: RO-IGM-TR-0002
		Issue: 2
		Revision: 2
IGM	Institut für Geophysik und Meteorologie Technische Universität Braunschweig	Date: October 10, 2001
		Page: 4



Figure 1: I010424A



Figure 2: I010423E

2 Monday March 19, 2001

2.1 Pre Calibration Residual Field Adjustment

Prior to the ROSETTA FGM calibration the status of the coil system concerning the residual field has been checked. For this purpose the Overhauser Magnetometer (OVH) was placed diagonally in space in the center of the coil system (CoC). The orientation of the sensor was from north-west-down to south-east-up. Fields have been applied with the S/W MCF_CTRL. The data output of the OVH was logged with HYPERTERM on a Laptop in House 1.

Initial measurement:

Component	Applied Field [nT]	Measured Modulus [nT]	Residual Field [nT]	Old PA-Offset
X	+50000	49998	+06	505
X	-50000	49987		
Y	+50000	49977	-20	390
Y	-50000	50016		
Z	+50000	50008	+10	690
Z	-50000	49988		

Status after adjustment:

Component	Applied Field [nT]	Measured Modulus [nT]	Residual Field [nT]	Old PA-Offset
X	+50000	49993	00	458
X	-50000	49993		
Y	+50000	49997	00	560
Y	-50000	50097		
Z	+50000	49998	00	600
Z	-50000	49998		

The measurement gave very stable results. The variation of the OVH output for a stable field configuration was in the order of a few tenth of a nanotesla.

R O S E T T A		Document: RO-IGM-TR-0002
		Issue: 2
		Revision: 2
IGM	Institut für Geophysik und Meteorologie	Date: October 10, 2001
	Technische Universität Braunschweig	Page: 6

2.2 Calibration Setup

After the described residual field adjustment to the real ROSETTA calibration session starts now with the system Setup.

The CDRS¹ is set up and configured in the standard way. All the coil facility devices work properly.

2.2.1 Hardware Setup

1. ROSETTA sensors unpacked and mounted on their aluminium support at house 2 mainroom.
2. The mirrors have been attached to the sensors (Mirror IB to the IB-sensor, mirror OB to the OB-Sensor).
3. DPU placed on the small desk in the southwest corner of the house 2 main room.
4. PIU-Simulator-Board installed at the house 2 anteroom.
5. PIU-Simulator output connected to CLUSTERM GSD-Port via RS-232 lines from house 2 to house 1.
6. S/C-Simulator connected to DPU.
7. DPU analog output: N/A
8. MAD-System. Only the ZOPFMAG actually connected.

Sensor	Line	MAD	Sensor	Line	MAD	Sensor	Line	MAD
Zopf-X _m	B1	Ch00		A1			A4	
Zopf-Y _m	B2	Ch01		A2			A5	
Zopf-Z _m	B3	Ch02		A3			B4	

9. The Zopfmagnetometer is placed at the lower central reference position in the coil system for the whole calibration. Actual sensitivity: 1000 nT/V.

The hardware setup is completed, so now the software has to be checked.

¹Calibration and Data Recording System

R O S E T T A		Document: RO-IGM-TR-0002
		Issue: 2
		Revision: 2
IGM	Institut für Geophysik und Meteorologie	Date: October 10, 2001
	Technische Universität Braunschweig	Page: 7

2.2.2 Software Setup

The following table lists the current versions of the used software packages.

Computer	Software	Version / Date	Remark
MRode	Mag_Out	28.0 / 20.10.1999	
	SimElnk		No Ops
	Mag_Sim	3.1a / 20.07.1998	
	Elnk2Cmd.def		No Ops
ClusTerm	RoseTerm	1.1! / 04.12.2000	
TempCtrl	TempCtrl	4.6 / 12.09.1997	
	Analyser		No Ops
MAD	MessAuf	1.4a / 10.04.1997	
any	CCD2T	4.6c / 17.11.1998	
	CCR2CCD	1.3 / 09.11.1998	
	CCD2ROS	1.1 / 16.11.2000	

The system starts without complications.

2.3 Offset Measurements — DPU: FM, Sensors FM-IB & FM-OB

To perform the offset measurements both sensors are mounted with their aluminium support at the stand on top of the green trolley. Figure 236 shows a photographic view of the setup in the normal position for the measurement of FGM-OB. The following figures show the turned positions according to the test procedure.

Purpose: Measure the FGM-IB & and FGM-OB offset.
MAD: Ch0 to Ch2 connected to ZopfMag x to z, 1 nT/mV;
Ch7 FSP pulse;
Timer 500, SumUp 100, Vector rate 1.00 Hz.

PREMA:
Files: OFF?_?1.SEQ
Start: 19.03.01 15:01
End: 19.03.01 16:10

R O S E T T A		Document: RO-IGM-TR-0002
		Issue: 2
		Revision: 2
IGM	Institut für Geophysik und Meteorologie Technische Universität Braunschweig	Date: October 10, 2001
		Page: 8

2.3.1 Data

Configuration File	CCD File	Position Picture
		Position 1: Normal OB @ CoC, height: 13cm, 010405A
ALI10.cfg	01-03-19\15_01_03.CCD	
OFFX_N1.cfg	01-03-19\15_08_30.CCD	

Configuration File	CCD File	Position Picture
		Position 2: Normal IB @ CoC, height: 13cm, 010405B
OFFX_N1.cfg	01-03-19\15_12_37.CCD	

Configuration File	CCD File	Position Picture
		Position 3: Turned @ \Zc OB @ CoC, height: 13cm, 010405C
ALI10.cfg	01-03-19\15_29_16.CCD	
OFFX_T1.cfg	01-03-19\15_36_45.CCD	

Configuration File	CCD File	Position Picture
		Position 4: Turned @ \Zc IB @ CoC, height: 13cm, 010405D
OFFX_T1.cfg	01-03-19\15_42_39.CCD	

Configuration File	CCD File	Position Picture
		Position 5: Turned @ \Yc OB @ CoC, height: 20cm, 010405E
ALI10.cfg	01-03-19\15_53_19.CCD	
OFFZ_T1.cfg	01-03-19\16_00_30.CCD	

Configuration File	CCD File	Position Picture
		Position 6: Turned @ \Yc IB @ CoC, height: 20cm, 010405F
OFFZ_T1.cfg	01-03-19\16_07_30.CCD	

R O S E T T A		Document: RO-IGM-TR-0002
		Issue: 2
		Revision: 2
IGM	Institut für Geophysik und Meteorologie Technische Universität Braunschweig	Date: October 10, 2001
		Page: 9

2.4 Linearity, Sensitivity and Cross Talk — DPU: FM, Sensors FM-IB & FM-OB

As a short test over night the system has been set up for linearity, sensitivity and cross talk measurements. The sensors were aligned geometrically using the aluminium support on top of the thermobox mounting plate. The OB sensor was in the north, IB in the south, the center of this double-sensor configuration at the CoC.

Purpose: Measure the linearity, sensitivity and cross talk data set
Conditions: Both sensors in geometrically aligned position.
CoC in center between FGM-OB and FGM-IB
MAD: Ch0 to Ch2 connected to ZopfMag x to z, 10 nT/mV;
Ch7 FSP pulse;
Timer 500, SumUp 100, Vectorrate 1.00 Hz.
Files: M010319.SEQ
Start: 19.03.01 16:23
End: 20.03.01 09:58

2.4.1 Data

Configuration File	CCD File	CCD File
ALI10.cfg	01-03-19\16_23_48.CCD	
14000XYZ.CFG	01-03-19\16_31_23.CCD	01-03-19\20_21_50.CCD
LX15.CFG	01-03-19\17_04_04.CCD	01-03-19\20_54_30.CCD
LY15.CFG	01-03-19\17_35_25.CCD	01-03-19\21_25_30.CCD
LZ15.CFG	01-03-19\18_06_26.CCD	01-03-19\21_56_30.CCD
SP15.CFG	01-03-19\18_37_27.CCD	01-03-19\22_27_31.CCD

2.5 Overview Plots: System Performance, Temperatures and Earthfield Variations.

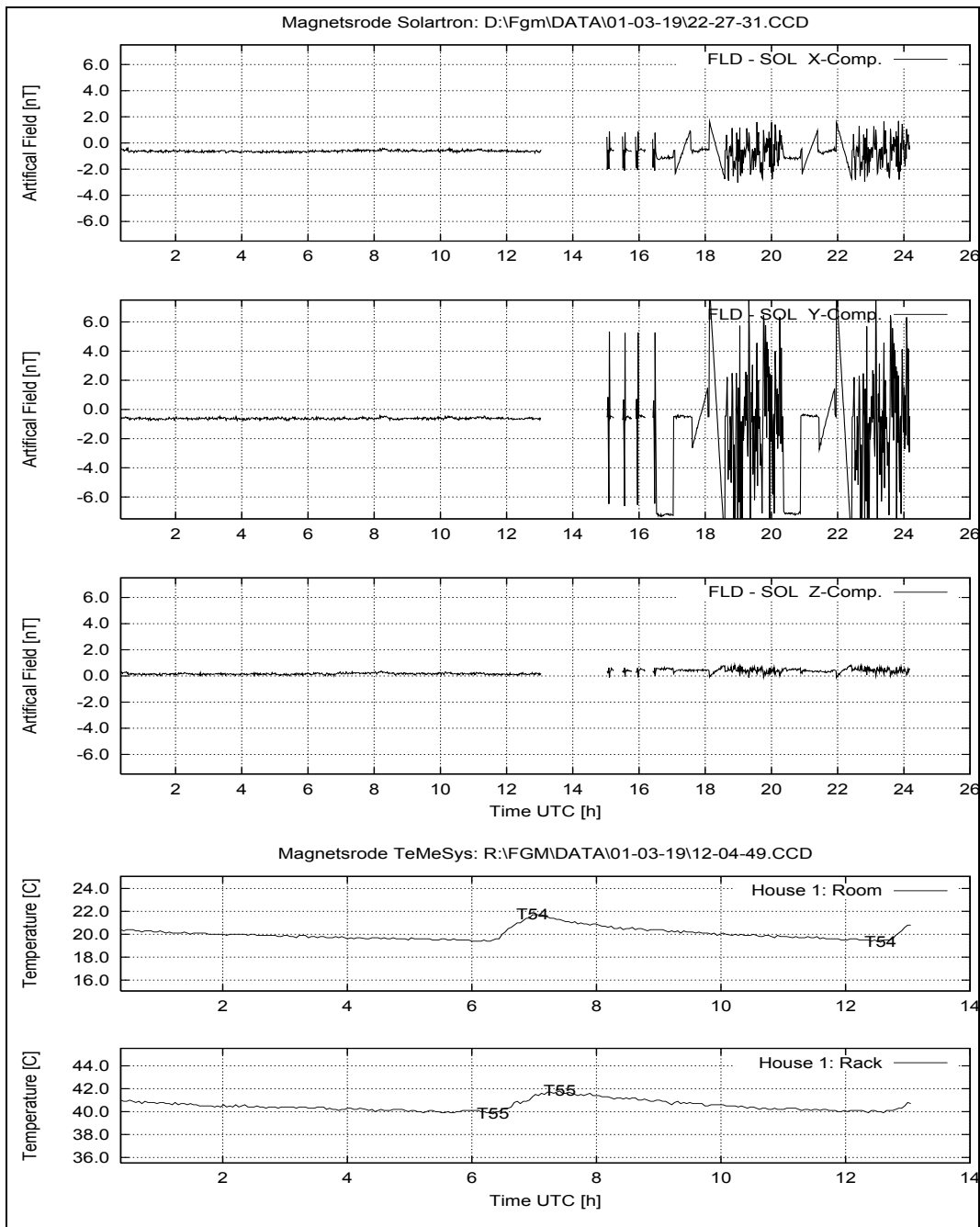

Figure 3: March 19, 2001: System Performance: FLD – SOL; Temperatures at House 1.

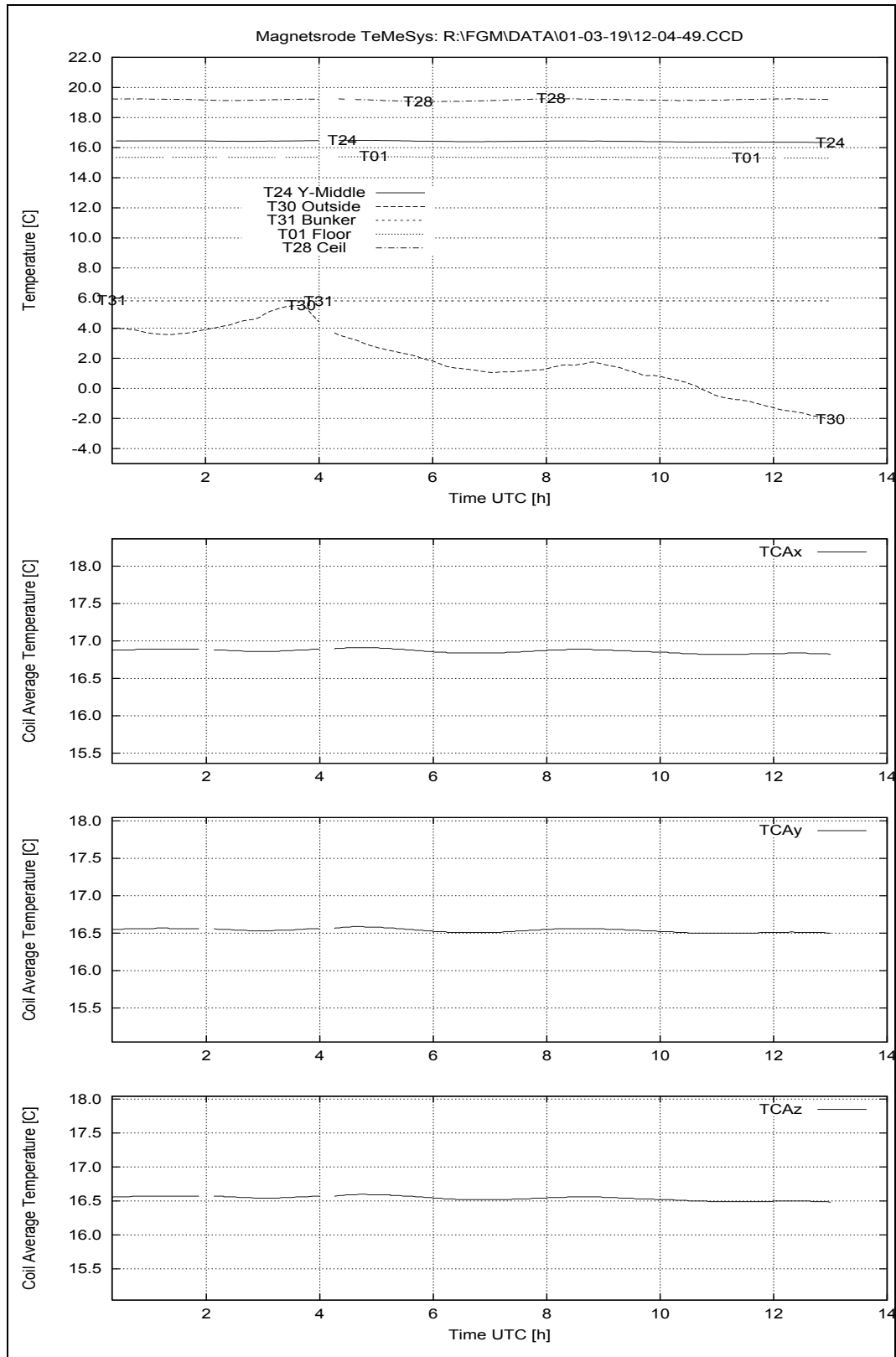

Figure 4: March 19, 2001: Temperatures House 2.

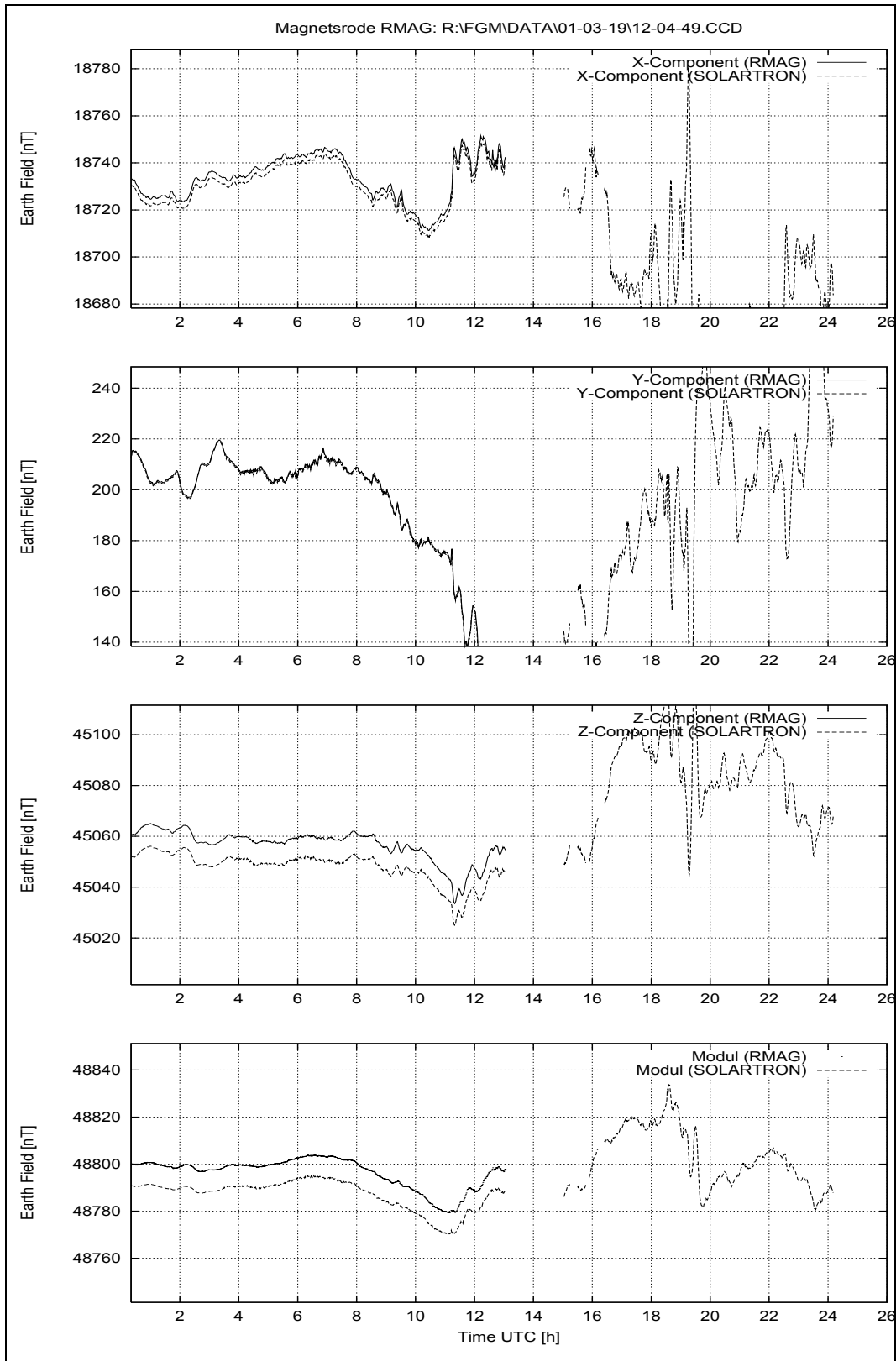

Figure 5: March 19, 2001: Earthfield variations.

R O S E T T A		Document: RO-IGM-TR-0002
IGM Institut für Geophysik und Meteorologie Technische Universität Braunschweig		Issue: 2
		Revision: 2
		Date: October 10, 2001
		Page: 13

3 Tuesday March 20, 2001

3.1 Linearity, Sensitivity and Cross Talk — DPU: FM, Sensors FM-IB & FM-OB — Continued

The linearity, sensitivity and cross talk measurements continued over night.

3.1.1 Data

Configuration File	CCD File
14000XYZ.CFG	01-03-20\00_11_53.CCD
LX15.CFG	01-03-20\00_44_33.CCD
LY15.CFG	01-03-20\01_15_51.CCD
LZ15.CFG	01-03-20\01_46_51.CCD
SP15.CFG	01-03-20\02_17_51.CCD
14000XYZ.CFG	01-03-20\04_02_13.CCD
LX15.CFG	01-03-20\04_34_53.CCD
LY15.CFG	01-03-20\05_05_52.CCD
LZ15.CFG	01-03-20\05_36_52.CCD
SP15.CFG	01-03-20\06_07_53.CCD
14000XYZ.CFG	01-03-20\07_52_14.CCD
LX15.CFG	01-03-20\08_25_24.CCD
LY15.CFG	01-03-20\08_56_24.CCD
LZ15.CFG	01-03-20\09_27_25.CCD
SP15.CFG	01-03-20\09_58_26.CCD

Afterwards the sensors have been dismantled for mechanical fine tuning.

3.2 Overview Plots: System Performance, Temperatures and Earthfield Variations.

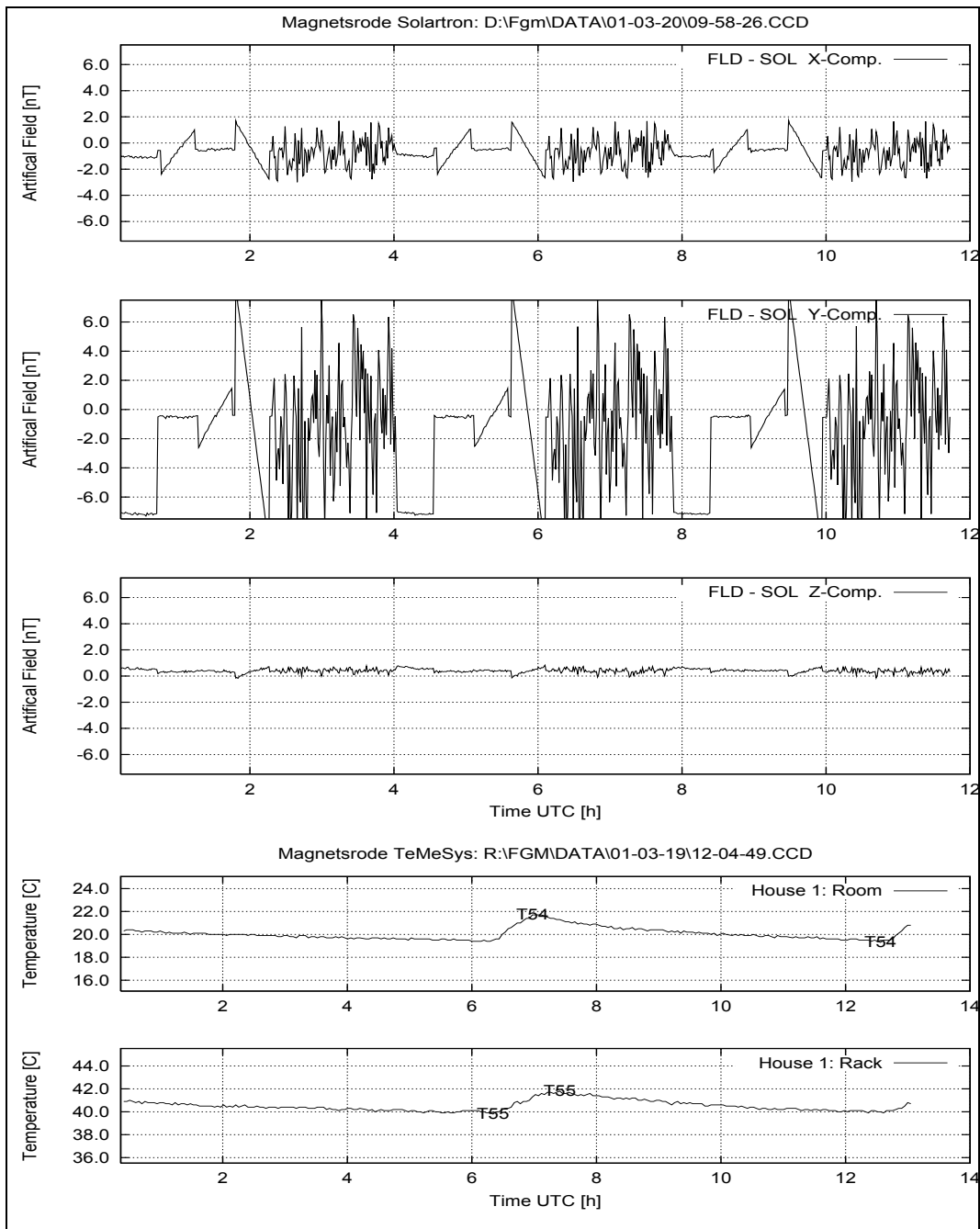

Figure 6: March 20, 2001: System Performance: FLD – SOL; Temperatures at House 1.

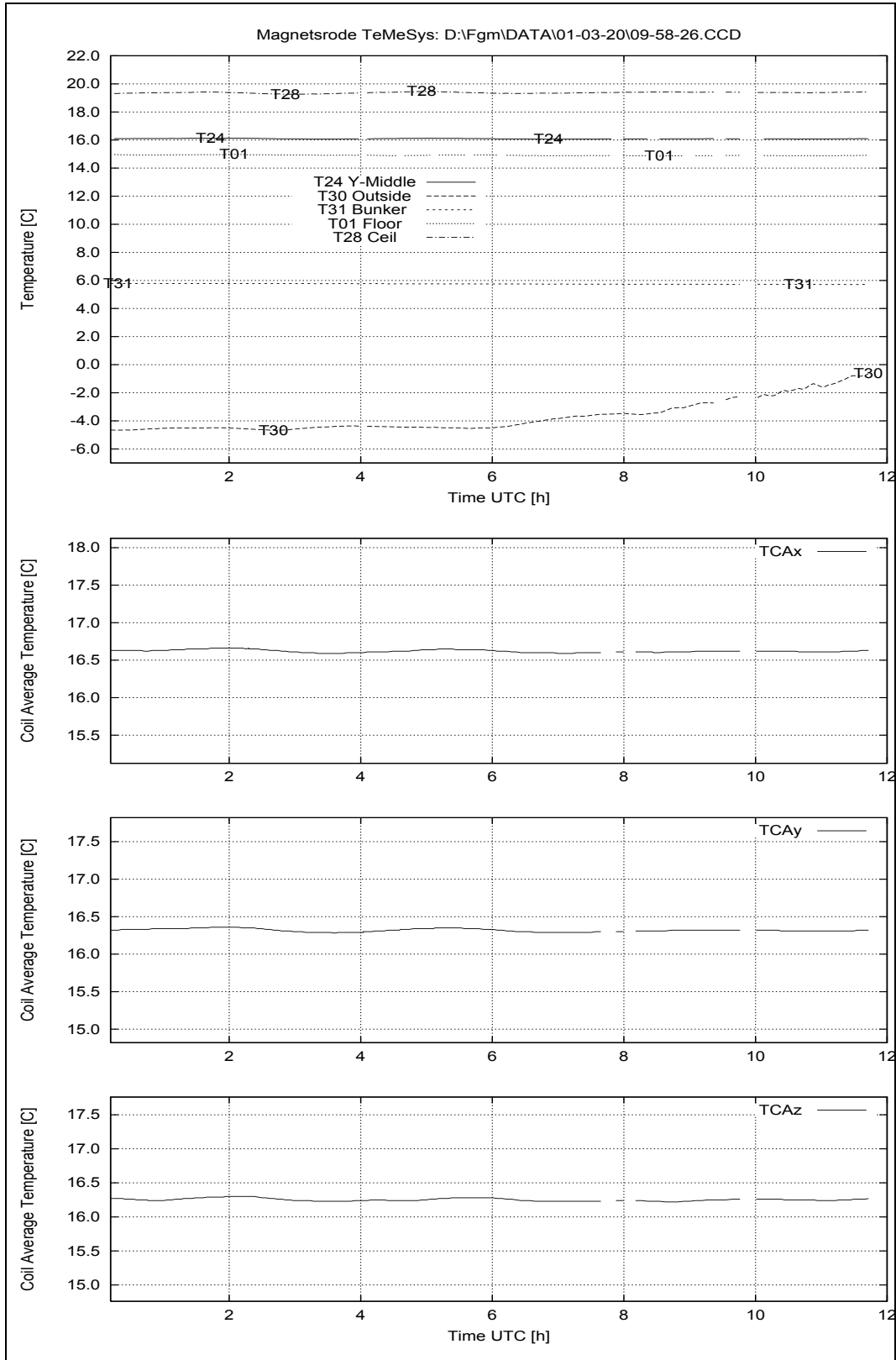

Figure 7: March 20, 2001: Temperatures House 2.

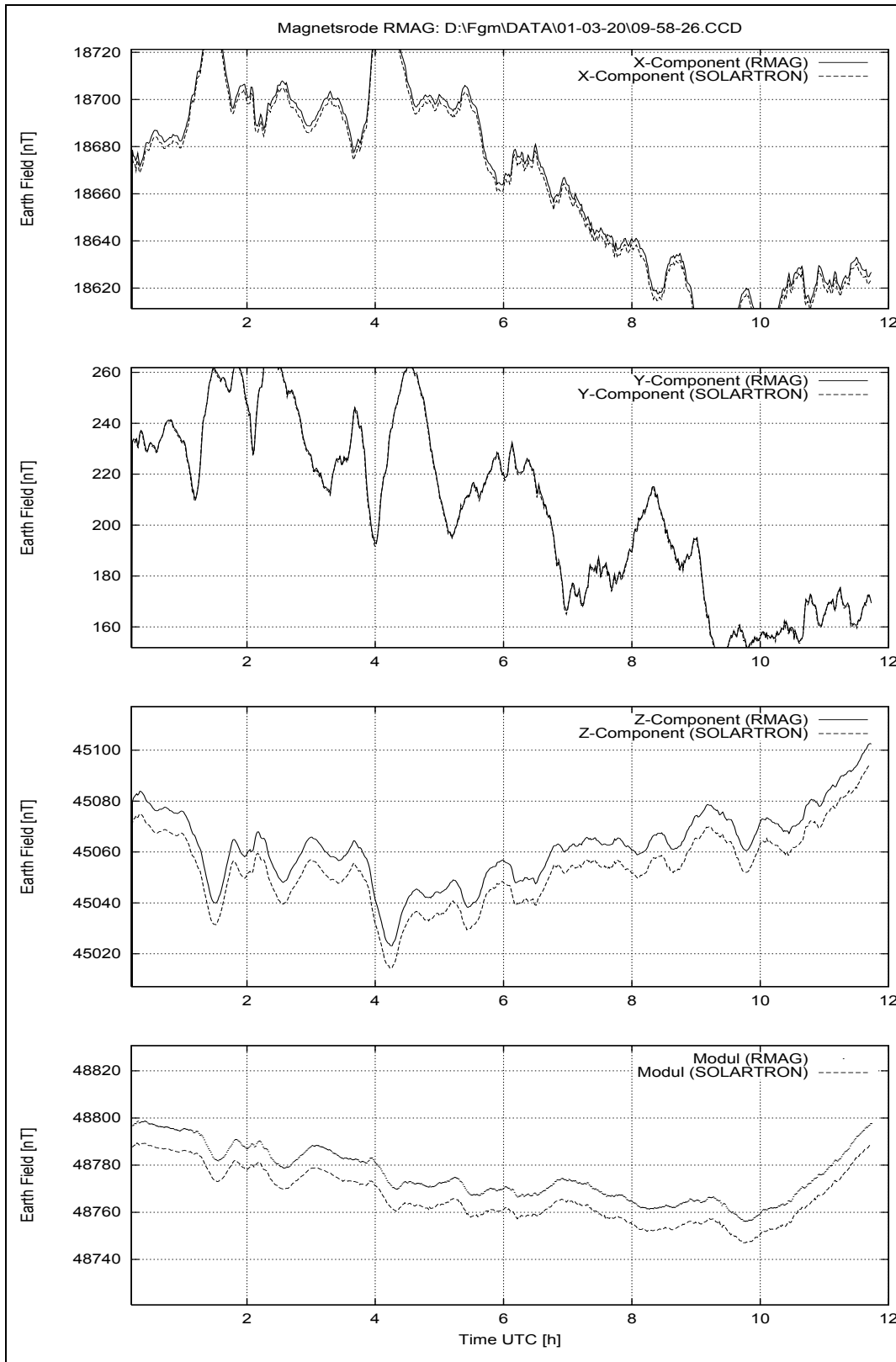

Figure 8: March 20, 2001: Earthfield variations.

R O S E T T A		Document: RO-IGM-TR-0002
IGM Institut für Geophysik und Meteorologie Technische Universität Braunschweig		Issue: 2
		Revision: 2
		Date: October 10, 2001
		Page: 17

4 Wednesday March 21, 2001

After the data collection the optical alignment took place for the FGM-OB sensor.

4.1 Optical Alignment System

The optical alignment system at Magnetsrode is shown in figure 9. The laser is mounted on a turntable. Its angular position is indicated in degrees and minutes. The angles between the reference mirror, the centerline of the coil system and the cross mirror are well known from a former calibration of this system. The crossing of centerline and cross mirror beam gives exactly the geometrical center of the coil system. The cube mirror of the magnetometer sensor is positioned at the center of the coil system in a way that the laser beam is nearly autocollimated. Figure 10 shows all the positions for the optical alignments of the FGM sensors.

4.2 FGM-OB: Optical Alignment

The standard procedure for the optical alignment of a sensor is performed. The results are shown in the following tables 1 and 2. The Thermal Test Box is used as stand for the sensor. The sensor is placed in the center of the Test Box mounting plate. As the alignment control axes of the box are not orthogonal, the alignment has to be repeated some times between the magnetometer position and the cross position of the laser to iterate to the best position. The remaining error is shifted to the cross position and noticed there (see tables 1 and 2).

Prior to the optical alignment the mirror #OB has been mounted on the northern OB sensor. Refer to picture 231. As parts of the laser tripod system should be used for the ROSETTA EMC Test at Alenia, the laser system had to be re-assembled and to be recalibrated before the real optical alignment procedure could be executed. This was done successfully in some hours work.

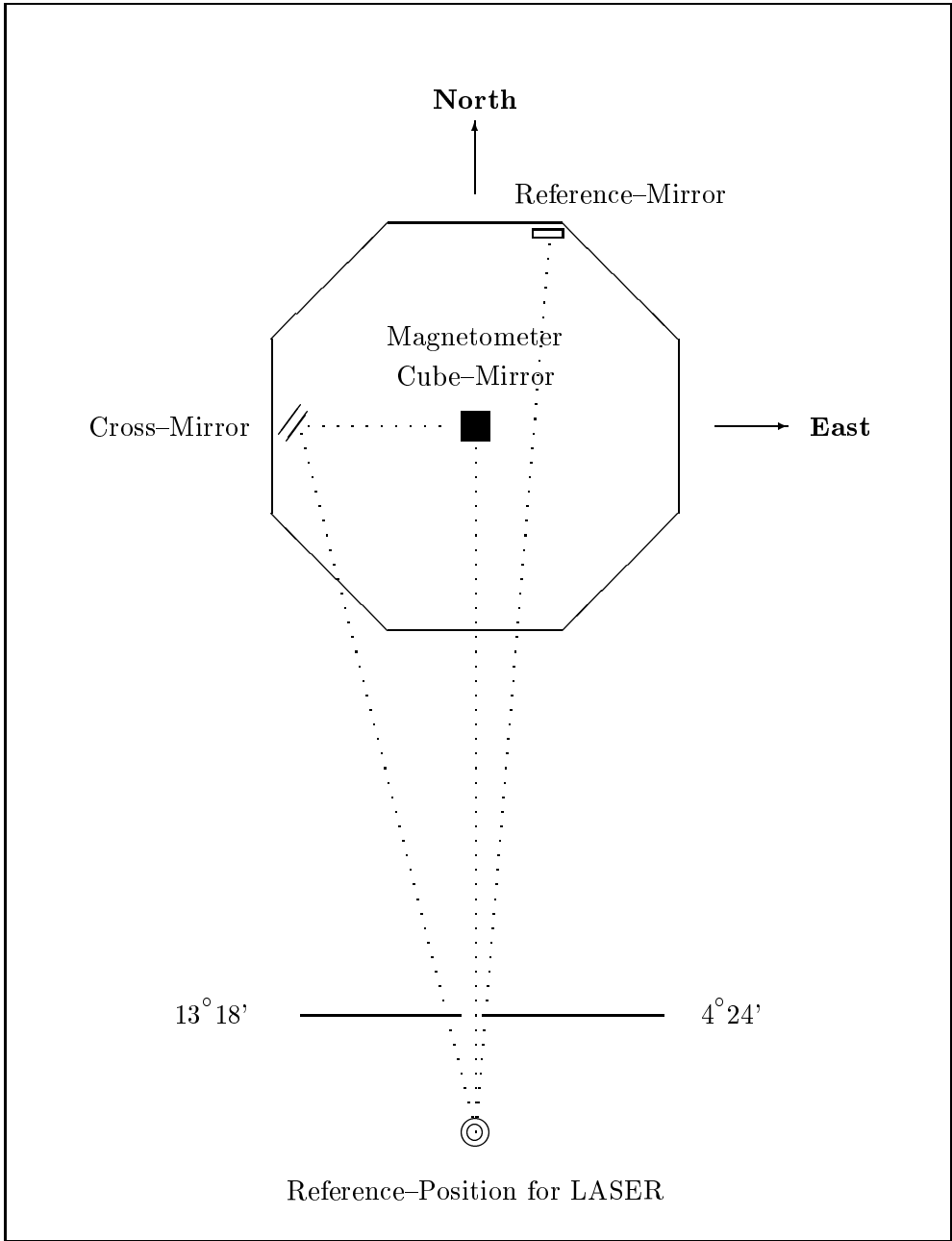

Figure 9: Sketch of the optical alignment system at Magnetsrode. (View from the top.)

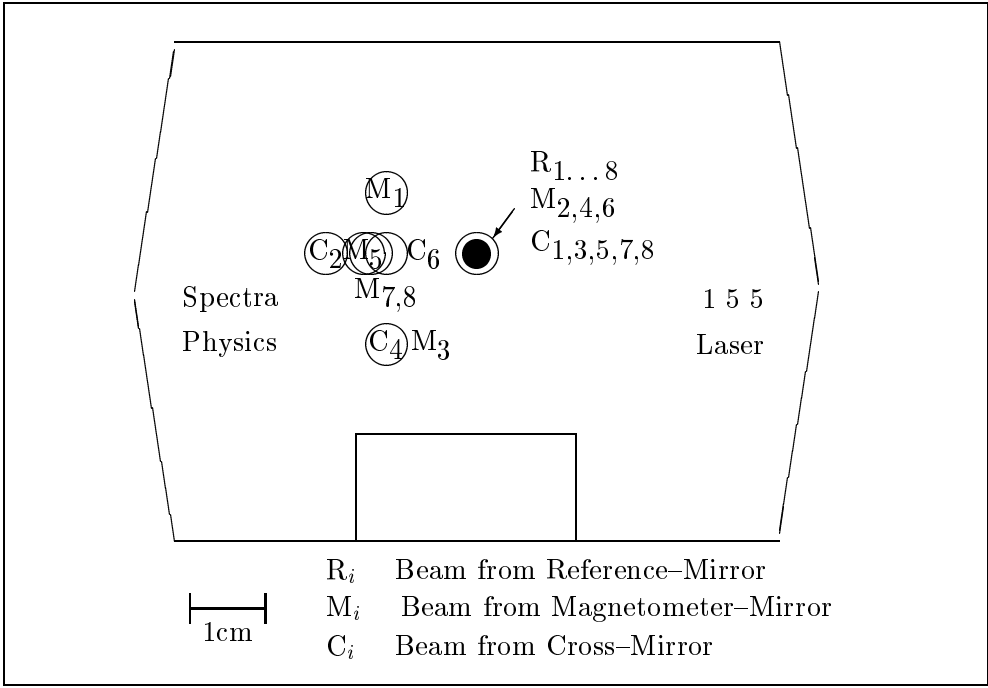

Figure 10: The Laser front plate with the reflected beams of the optical alignment.

R O S E T T A		Document: RO-IGM-TR-0002
IGM Institut für Geophysik und Meteorologie Technische Universität Braunschweig		Issue: 2
		Revision: 2
		Date: October 10, 2001
		Page: 20

Laser at	Turntable angles			
	FM-OB: 21.03.01	FM-IB: 22.03.01	FS-OB: 05.04.01	FS-IB: 06.04.01
Reference-Mirror	$R_1 = 328^\circ 01'$	$R_2 = 329^\circ 32'$	$R_3 = 328^\circ 12'$	$R_4 = 328^\circ 24'$
FGM	$M_1 = 323^\circ 37'$	$M_2 = 325^\circ 08'$	$M_3 = 323^\circ 48'$	$M_4 = 324^\circ 00'$
difference	$x = -12$ mm	$x = +00$ mm	$x = -12$ mm	$x = +00$ mm
	$y = +08$ mm	$y = +00$ mm	$y = -12$ mm	$y = +00$ mm
Cross-Mirror	$C_1 = 310^\circ 19'$	$C_2 = 311^\circ 50'$	$C_3 = 310^\circ 30'$	$C_4 = 310^\circ 42'$
difference	$x = +00$ mm	$x = -20$ mm	$x = +00$ mm	$x = -12$ mm
	$y = +00$ mm	$y = +00$ mm	$y = +00$ mm	$y = -12$ mm
Top-Laser	shadowed	shadowed	shadowed	shadowed

Table 1: Data of the optical alignment procedures performed during the calibration. Part 1

Laser at	Turntable angles			
	FS-IB: 20.04.01	FS-OB: 21.04.01	FS-IB: 23.04.01	FS-OB: 24.04.01
Reference-Mirror	$R_5 = 328^\circ 26'$	$R_6 = 328^\circ 20'$	$R_7 = 328^\circ 16'$	$R_8 = 328^\circ 26'$
FGM	$M_5 = 324^\circ 02'$	$M_6 = 323^\circ 56'$	$M_7 = 323^\circ 52'$	$M_8 = 324^\circ 02'$
difference	$x = -15$ mm	$x = +00$ mm	$x = -14$ mm	$x = -14$ mm
	$y = +00$ mm	$y = +00$ mm	$y = +00$ mm	$y = +00$ mm
Cross-Mirror	$C_5 = 310^\circ 44'$	$C_6 = 310^\circ 38'$	$C_7 = 310^\circ 34'$	$C_8 = 310^\circ 44'$
difference	$x = +00$ mm	$x = -12$ mm	$x = +00$ mm	$x = +00$ mm
	$y = +00$ mm	$y = +00$ mm	$y = +00$ mm	$y = +00$ mm
Top-Laser	shadowed	shadowed	shadowed	shadowed

Table 2: Data of the optical alignment procedures performed during the calibration. Part 2

R O S E T T A		Document: RO-IGM-TR-0002
		Issue: 2
		Revision: 2
IGM	Institut für Geophysik und Meteorologie Technische Universität Braunschweig	Date: October 10, 2001
		Page: 21

4.3 Linearity, Sensitivity and Cross Talk — DPU: FM, Sensors: FM-OB

After the optical alignment of the FM-OB sensor (refer to table 1 column #1) the linearity, sensitivity and cross talk measurements should be performed. Unluckily a power breakdown on the complete MRode Facility occurred at 11:00 and lasted until 12:20.

After a subsequent system setup and check we started the desired measurements.

Purpose: Measure the linearity, sensitivity and cross talk data set
Conditions: FM-OB in optical aligned position at CoC
FM-IB south of CoC on aluminium support.
Refer to picture 231.
MAD: Ch0 to Ch2 connected to ZopfMag x to z, 10 nT/mV;
Ch7 FSP pulse;
Timer 500, SumUp 100, Vectorrate 1.00 Hz.
Files: M010321.SEQ
Start: 21.03.01 12:58
End: 22.03.01 11:16

4.3.1 Data

Configuration File	CCD File
ALI10.cfg	01-03-21\12_58_42.CCD
STABTST.cfg	01-03-21\13_06_10.CCD
STABTST.cfg	01-03-21\14_06_50.CCD
STABTST.cfg	01-03-21\15_07_30.CCD
STABTST.cfg	01-03-21\16_08_10.CCD
STABTST.cfg	01-03-21\17_08_50.CCD
STABTST.cfg	01-03-21\18_09_30.CCD
LX15.CFG	01-03-21\19_10_11.CCD
LY15.CFG	01-03-21\19_41_11.CCD
LZ15.CFG	01-03-21\20_12_11.CCD
SP15spir.CFG	01-03-21\20_43_12.CCD

4.4 Overview Plots: System Performance, Temperatures and Earthfield Variations.

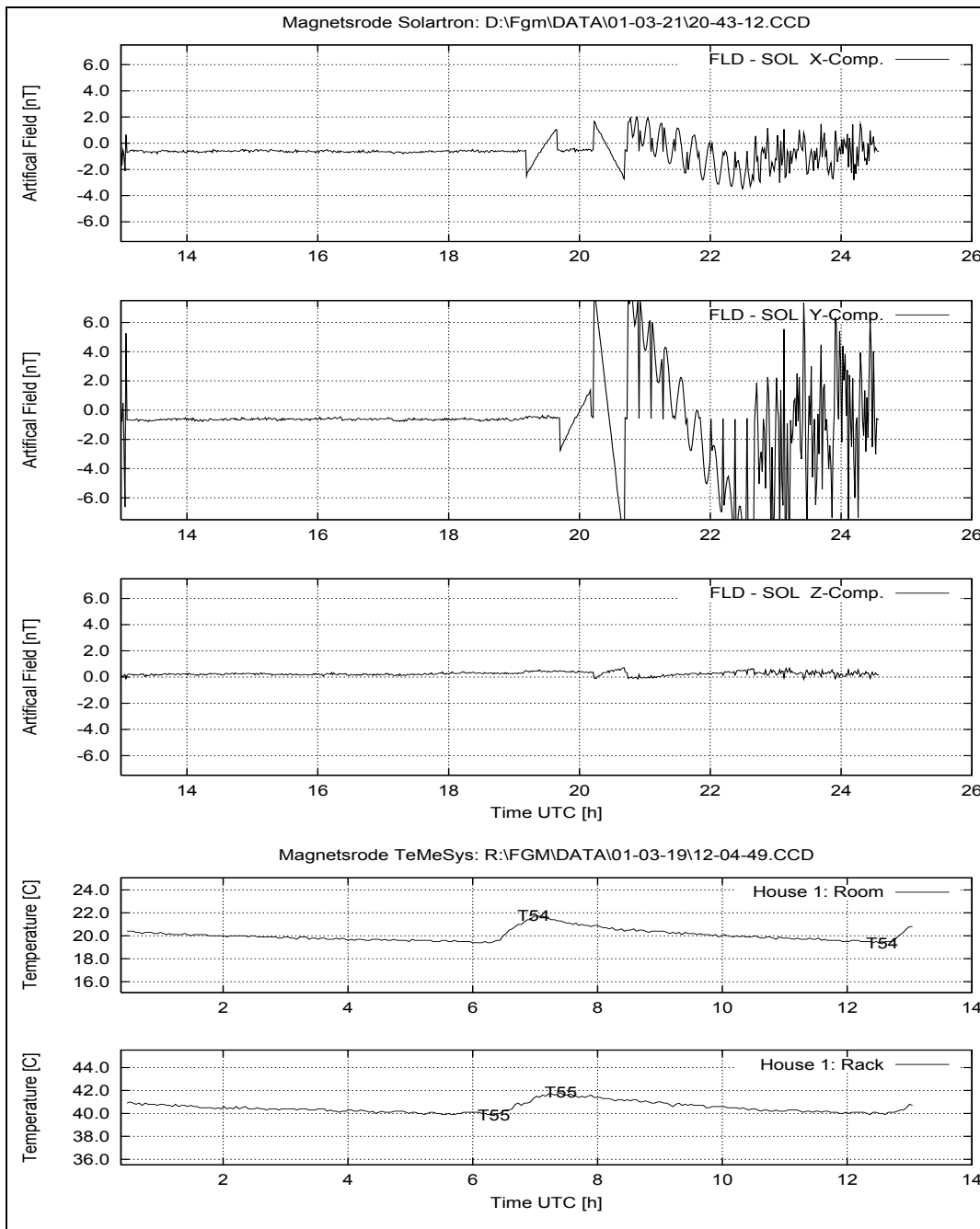

Figure 11: March 21, 2001: System Performance: FLD – SOL; Temperatures at House 1.

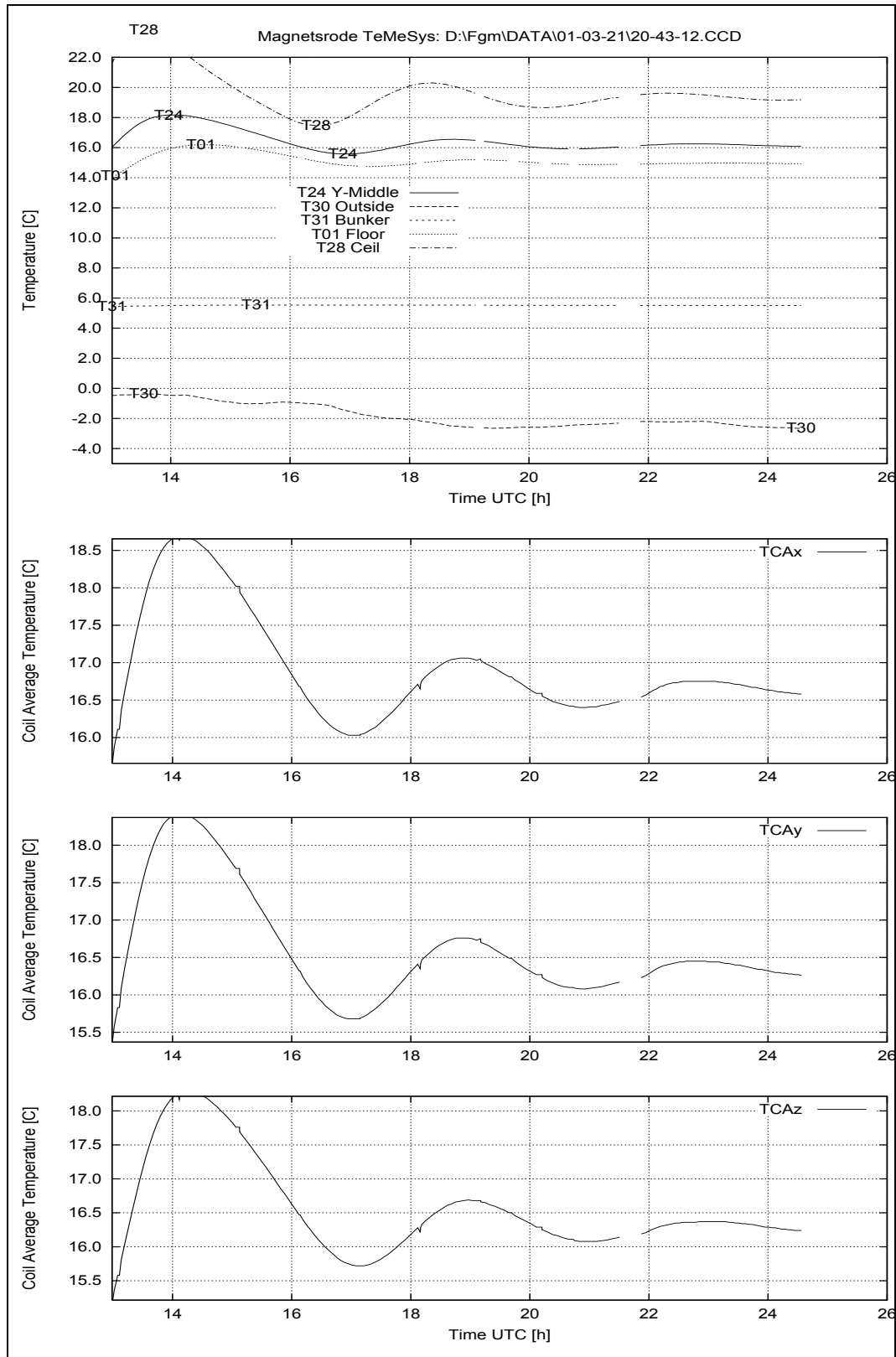

Figure 12: March 21, 2001: Temperatures House 2.

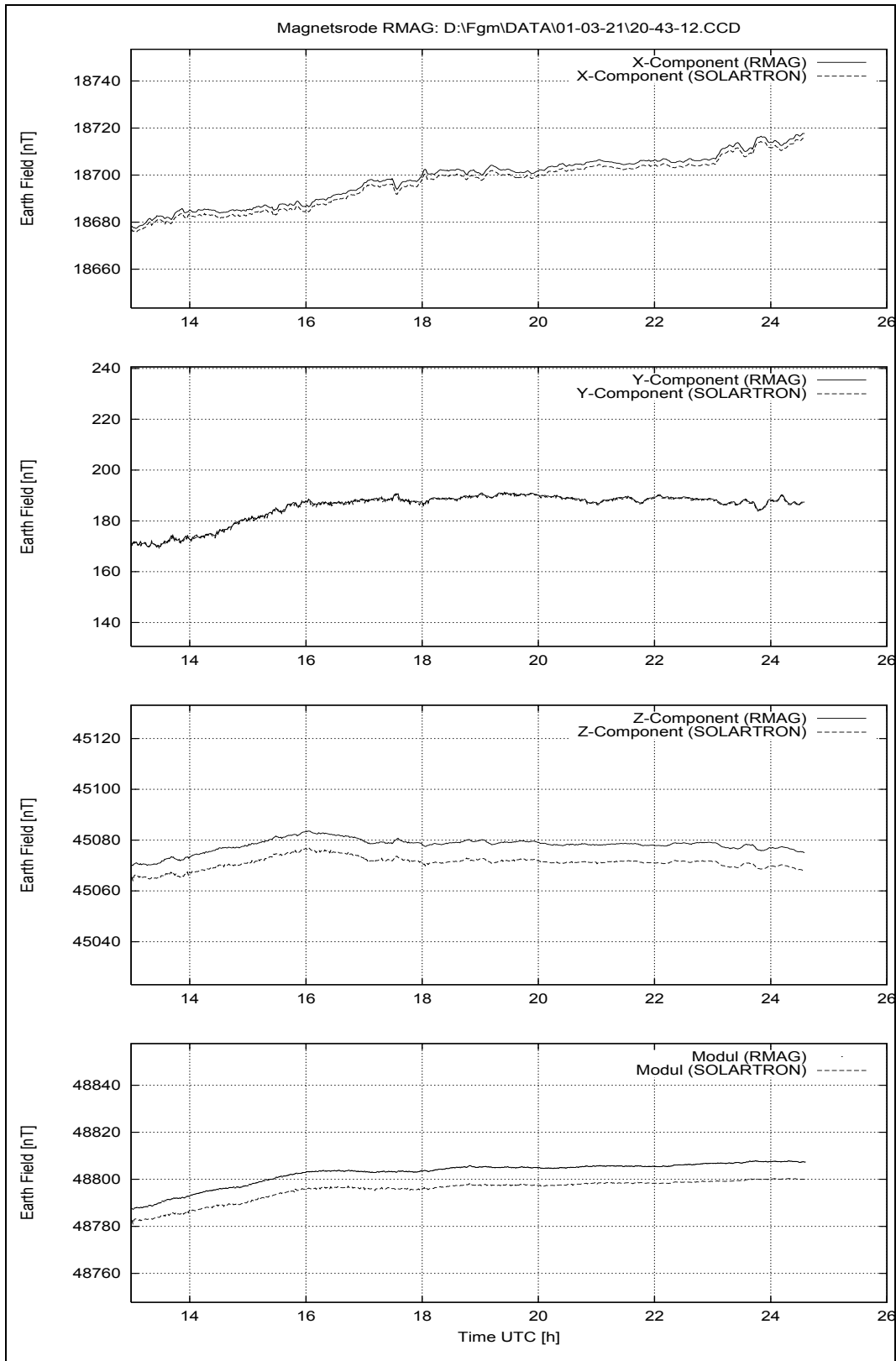

Figure 13: March 21, 2001: Earthfield variations.

R O S E T T A		Document: RO-IGM-TR-0002
		Issue: 2
		Revision: 2
IGM	Institut für Geophysik und Meteorologie	Date: October 10, 2001
	Technische Universität Braunschweig	Page: 25

5 Thursday March 22, 2001

5.1 Linearity, Sensitivity and Cross Talk — DPU: FM, Sensors: FM-OB — Continued

The linearity, sensitivity and cross talk measurements from yesterday were continued over night.

5.1.1 Data

Configuration File	CCD File
SP15sphe.CFG	01-03-22\00_35_57.CCD
LX15.CFG	01-03-22\05_08_37.CCD
LY15.CFG	01-03-22\05_39_37.CCD
LZ15.CFG	01-03-22\06_10_38.CCD
SP15sphe.CFG	01-03-22\06_41_38.CCD

After the data collection the setup was changed for the linearity measurements of the FM-IB sensor.

5.2 Linearity, Sensitivity and Cross Talk — DPU: FM, Sensors: FM-IB

The calibration mirror # IB was placed on the FM-IB sensor.
After the optical alignment of the FM-IB sensor (refer to table 1column #2) the linearity, sensitivity and cross talk measurements were initialised

Purpose: Measure the linearity, sensitivity and cross talk data set
Conditions: FM-IB in optical aligned position at CoC
FM-OB north of CoC on aluminium support.
Refer to picture 232 and picture 233.
MAD: Ch0 to Ch2 connected to ZopfMag x to z, 10 nT/mV;
Ch7 FSP pulse;
Timer 500, SumUp 100, Vectorrate 1.00 Hz.
Files: M010322.SEQ
Start: 22.03.01 12:44
End: 23.03.01 11:04

R O S E T T A		Document: RO-IGM-TR-0002
		Issue: 2
		Revision: 2
IGM	Institut für Geophysik und Meteorologie	Date: October 10, 2001
	Technische Universität Braunschweig	Page: 26

5.2.1 Data

Configuration File	CCD File
ALI10.cfg	01-03-22\12_44_38.CCD
STABTST.cfg	01-03-22\12_52_04.CCD
STABTST.cfg	01-03-22\13_52_45.CCD
STABTST.cfg	01-03-22\14_53_26.CCD
STABTST.cfg	01-03-22\15_54_07.CCD
STABTST.cfg	01-03-22\16_54_49.CCD
STABTST.cfg	01-03-22\17_55_30.CCD
LX15.CFG	01-03-22\18_56_10.CCD
LY15.CFG	01-03-22\19_27_12.CCD
LZ15.CFG	01-03-22\19_58_13.CCD
SP15spir.CFG	01-03-22\20_29_13.CCD

5.3 Overview Plots: System Performance, Temperatures and Earthfield Variations.

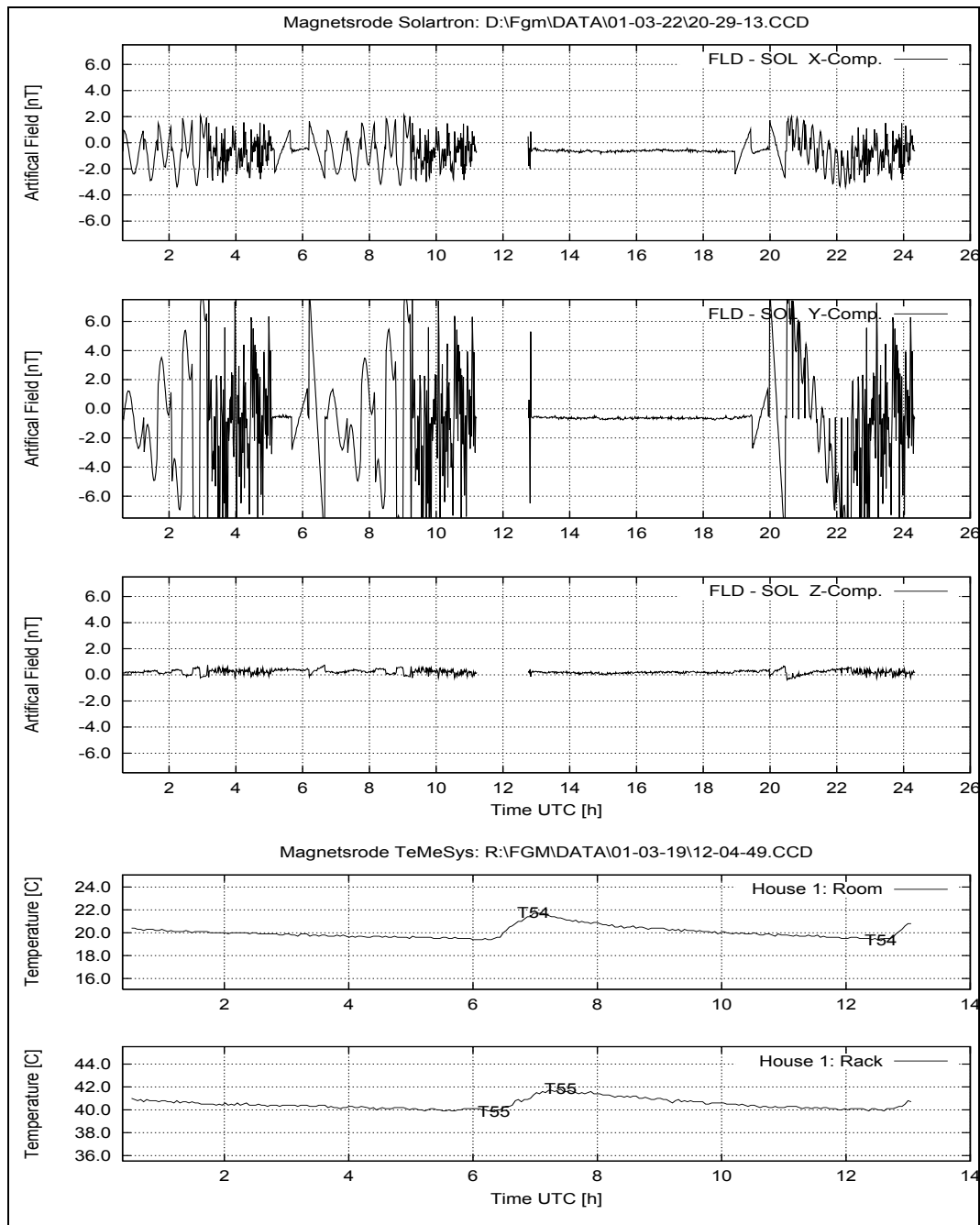

Figure 14: March 22, 2001: System Performance: FLD – SOL; Temperatures at House 1.

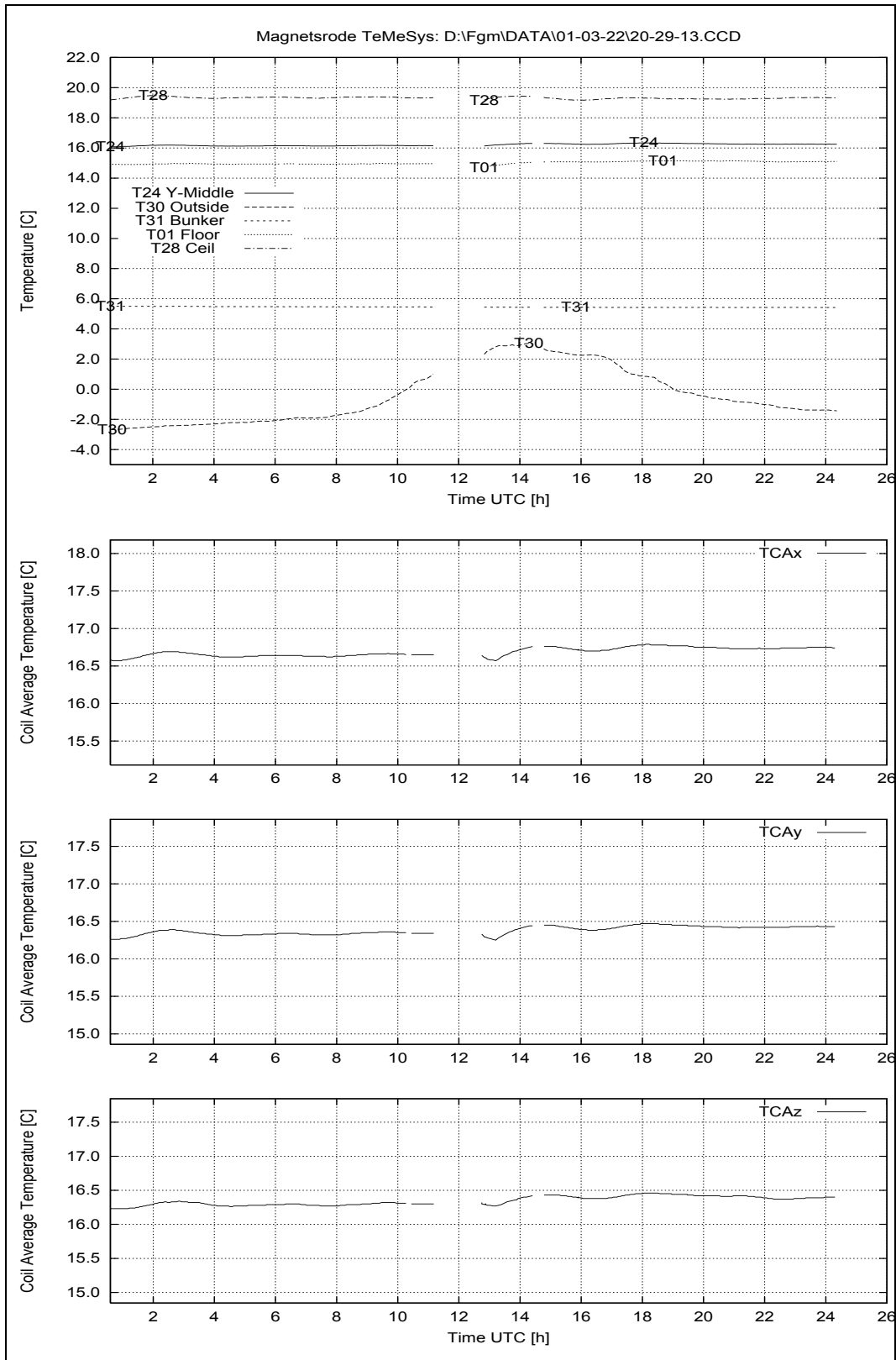

Figure 15: March 22, 2001: Temperatures House 2.

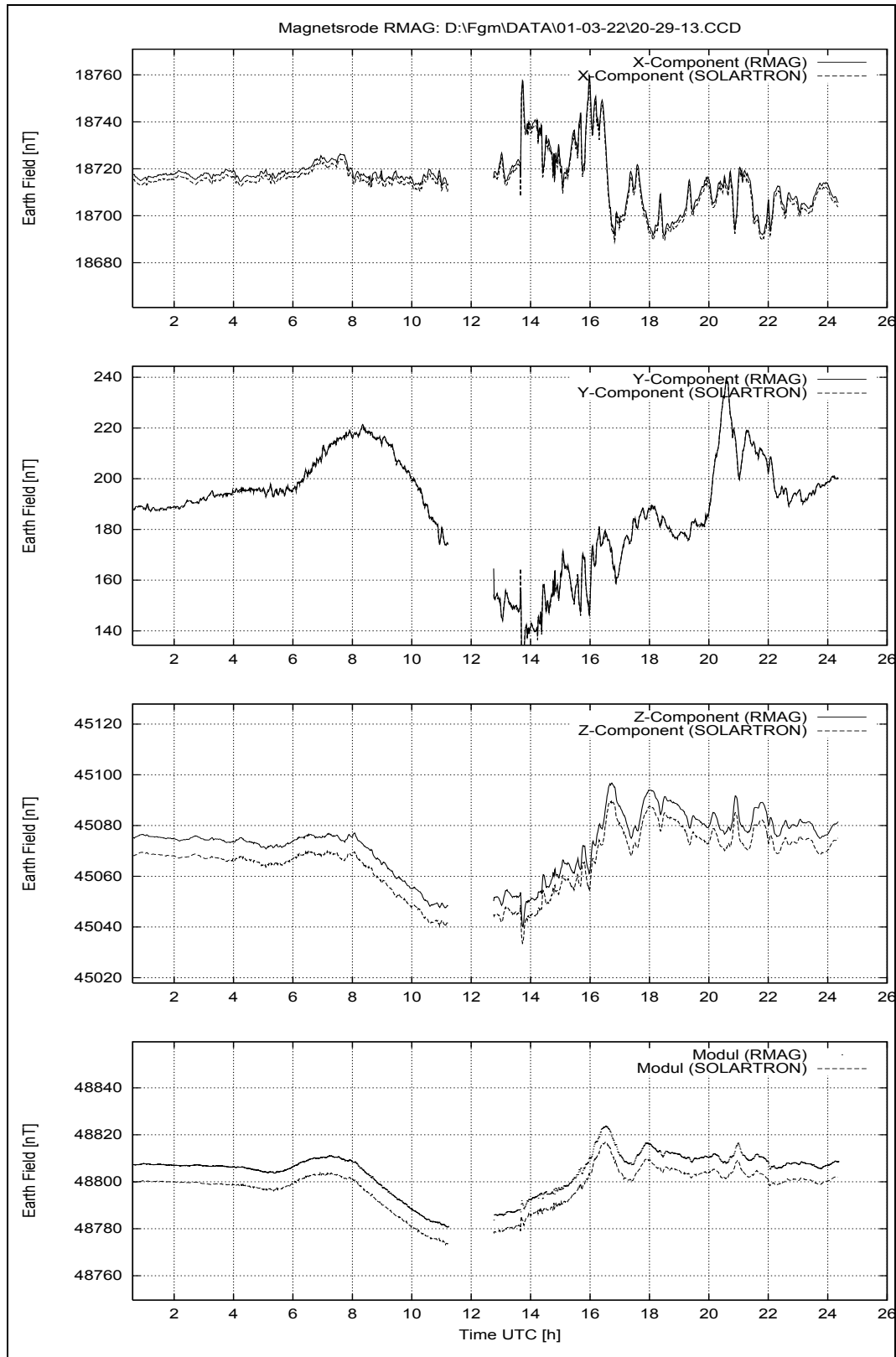

Figure 16: March 22, 2001: Earthfield variations.

R O S E T T A		Document: RO-IGM-TR-0002
		Issue: 2
		Revision: 2
IGM	Institut für Geophysik und Meteorologie	Date: October 10, 2001
	Technische Universität Braunschweig	Page: 30

6 Friday March 23, 2001

6.1 Linearity, Sensitivity and Cross Talk — DPU: FM, Sensors: FM-IB — Continued

The overnight measurement sequence was executed properly until noon.

6.1.1 Data

Configuration File	CCD File
SP15sphe.CFG	01-03-23\00_21_58.CCD
LX15.CFG	01-03-23\04_54_38.CCD
LY15.CFG	01-03-23\05_25_39.CCD
LZ15.CFG	01-03-23\05_58_17.CCD
SP15sphe.CFG	01-03-23\06_29_17.CCD

6.2 Setup for the Temperature Calibration

Both sensors, mounted together on their aluminium support, are fixed on the mounting plate of the Thermal Test Box. See figure 115 for details. Also a photographic view (figures 235 and 235) will help.

The FM-OB is on the northern side, FM-IB on the southern side. The temperature sensors of the TEMESYS-B system T₅₆ to T₆₃ are placed in the box. The positions are given in table 5.

Sensor	Position
T ₅₇	under FGM-OB sensor
T ₅₉	under FGM-IB sensor
T ₅₆	mounting plate, upper side, western edge, central
T ₅₈	mounting plate, upper side, south west corner
T ₂₉	outside thermal box at the northern side of the Coil System
T ₆₀	ground plate, north middle
T ₆₁	mounting plate, eastern side, central
T ₆₂	ground plate, south west
T ₆₃	ground plate, south east

Table 3: The TEMESYS-B sensors in the Thermal Test Box.

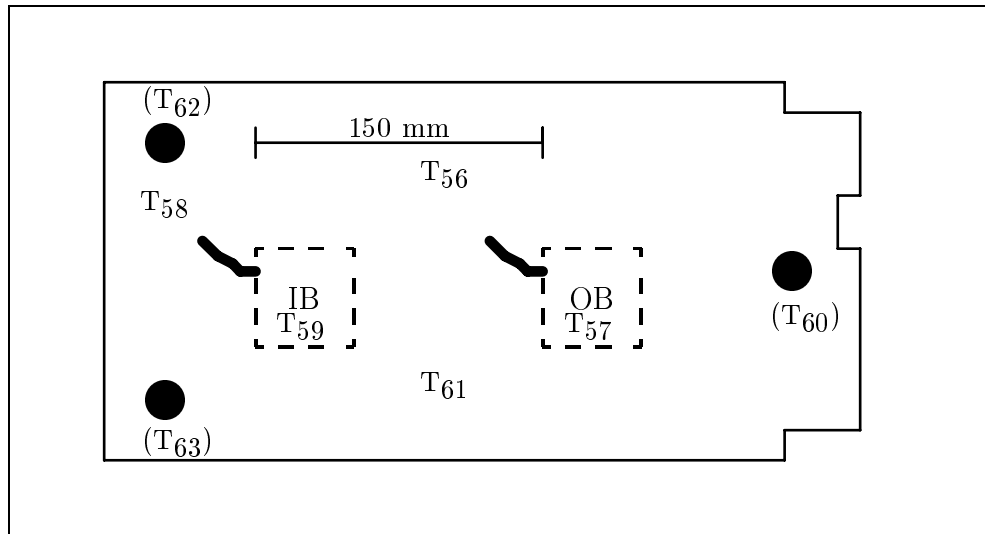

Figure 17: The temperature sensors at the Thermal Test Box mounting plate. The draft shows the top view. Sensors in brackets are mounted near the Thermal Test Box ground plate, not on the mounting plate.

The software `TEMPCTRL` is used to control the heating process. This software switches on the electrical heater during the `SOLARTRON` measurement cycle. This was done, because during the `SOLARTRON` measurements the data should not be used and so they may be disturbed anyway. For details on the heater and the control software see the related document *MR-IGM-TN0005*. The appendix E gives details on the measurements and shows an overview on the complete cooling and heating cycle.

6.3 Temperature Cycle, Linearities, FM Sensors

Before the temperature calibration will be performed some linearity measurements should be executed in the chosen setup for the temperature cycle. The sensors are fixed, but the box is still open for filling in the dry ice after these measurements.

Purpose: Measure the linearity of the FGM sensors.
Conditions: FM-OB and FM-IB placed in the Thermal Test Box on the aluminium support. The distance between them is 150 mm.
MAD: Ch0 to Ch2 connected to Zopfmag x to z, 10 nT/mV;
Ch7 FSP;
Timer 500, SumUp 100, Vectorrate 1.00 Hz.
Files: T_LIN.SEQ
Start: 23.03.01 12:21
End: 23.03.01 13:20

R O S E T T A		Document: RO-IGM-TR-0002
		Issue: 2
		Revision: 2
IGM	Institut für Geophysik und Meteorologie Technische Universität Braunschweig	Date: October 10, 2001
		Page: 32

6.3.1 Data

Configuration File	CCD File
ALI10.cfg	01-03-23\12_21_23.CCD
TX15.CFG	01-03-23\12_40_29.CCD
TY15.CFG	01-03-23\12_53_30.CCD
TZ15.CFG	01-03-23\13_06_31.CCD

6.4 Temperature Calibration, Cooling Cycle, FM Sensors

Purpose: Measure the temperature behaviour of the FM sensors.
Conditions: FM-OB and FM-IB placed in the Thermal Test Box on the aluminium support. The distance between them is 150 mm.
MAD: Ch0 to Ch2 connected to Zopfmag x to z, 10 nT/mV;
Ch7 FSP;
Timer 500, SumUp 100, Vectorrate 1.00 Hz.
Files: TEMP.SEQ
Temperature
File: ROSETTA1.CUR
Start: 23.03.01 13:26
End: 29.03.01 17:00 ESC.
Remark: 10 kg of broken dry ice are filled in during the first measurement.
Dry ice fill in completed at about 13:33

6.4.1 Data

Configuration File	CCD File	Remark
14000XYZ.CFG	01-03-23\13_26_01.CCD	Dry Ice filled in
ali10.CFG	01-03-23\13_58_41.CCD	
TEMP.CFG	01-03-23\14_05_56.CCD	
TEMP.CFG	01-03-23\15_13_37.CCD	
TEMP.CFG	01-03-23\16_21_17.CCD	
TEMP.CFG	01-03-23\17_28_58.CCD	
TEMP.CFG	01-03-23\18_36_39.CCD	
TEMP.CFG	01-03-23\19_44_20.CCD	
TEMP.CFG	01-03-23\20_52_00.CCD	
TEMP.CFG	01-03-23\21_59_40.CCD	
TEMP.CFG	01-03-23\23_07_21.CCD	

6.5 Overview Plots: System Performance, Temperatures and Earthfield Variations.

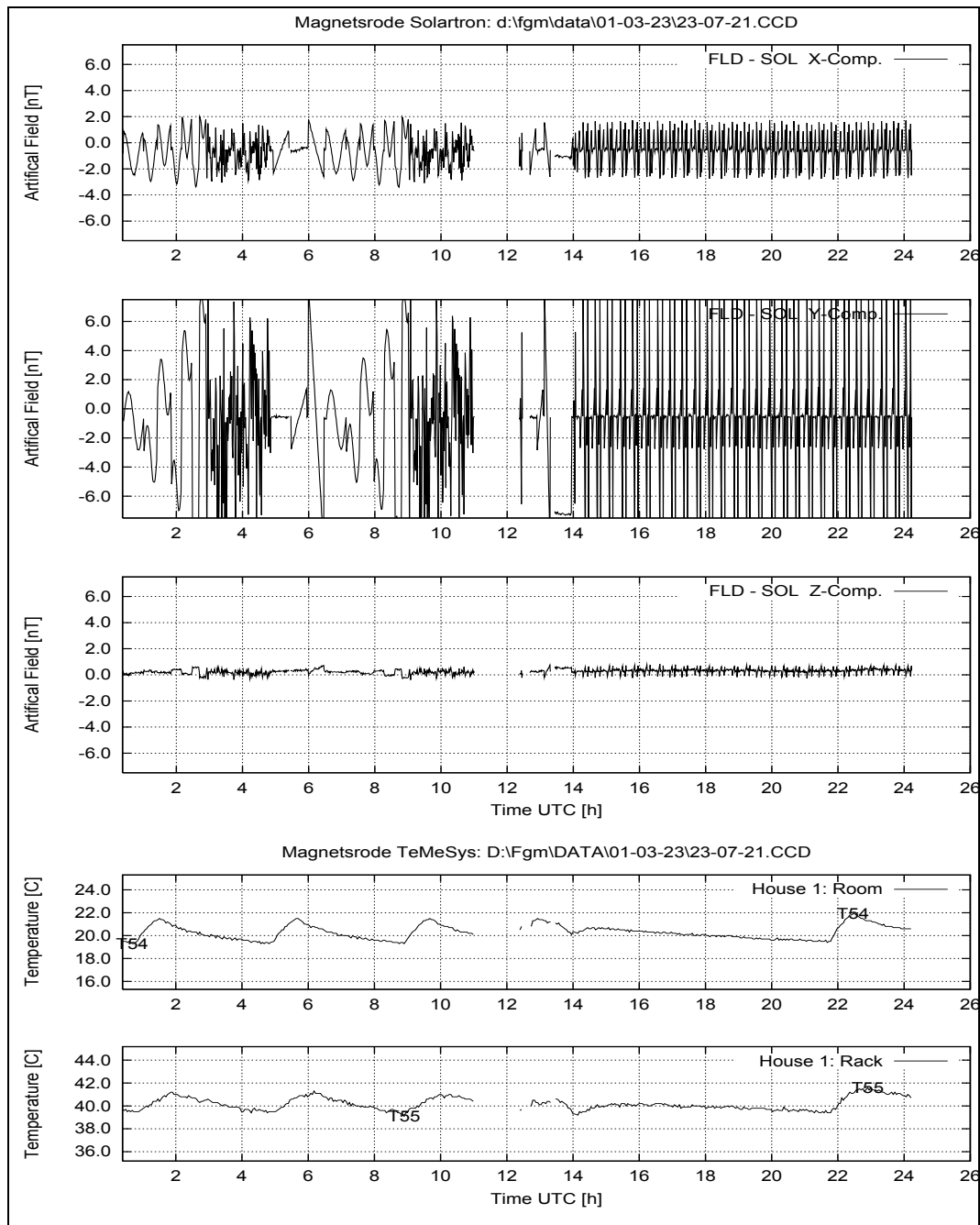

Figure 18: March 23, 2001: System Performance: FLD – SOL; Temperatures at House 1.

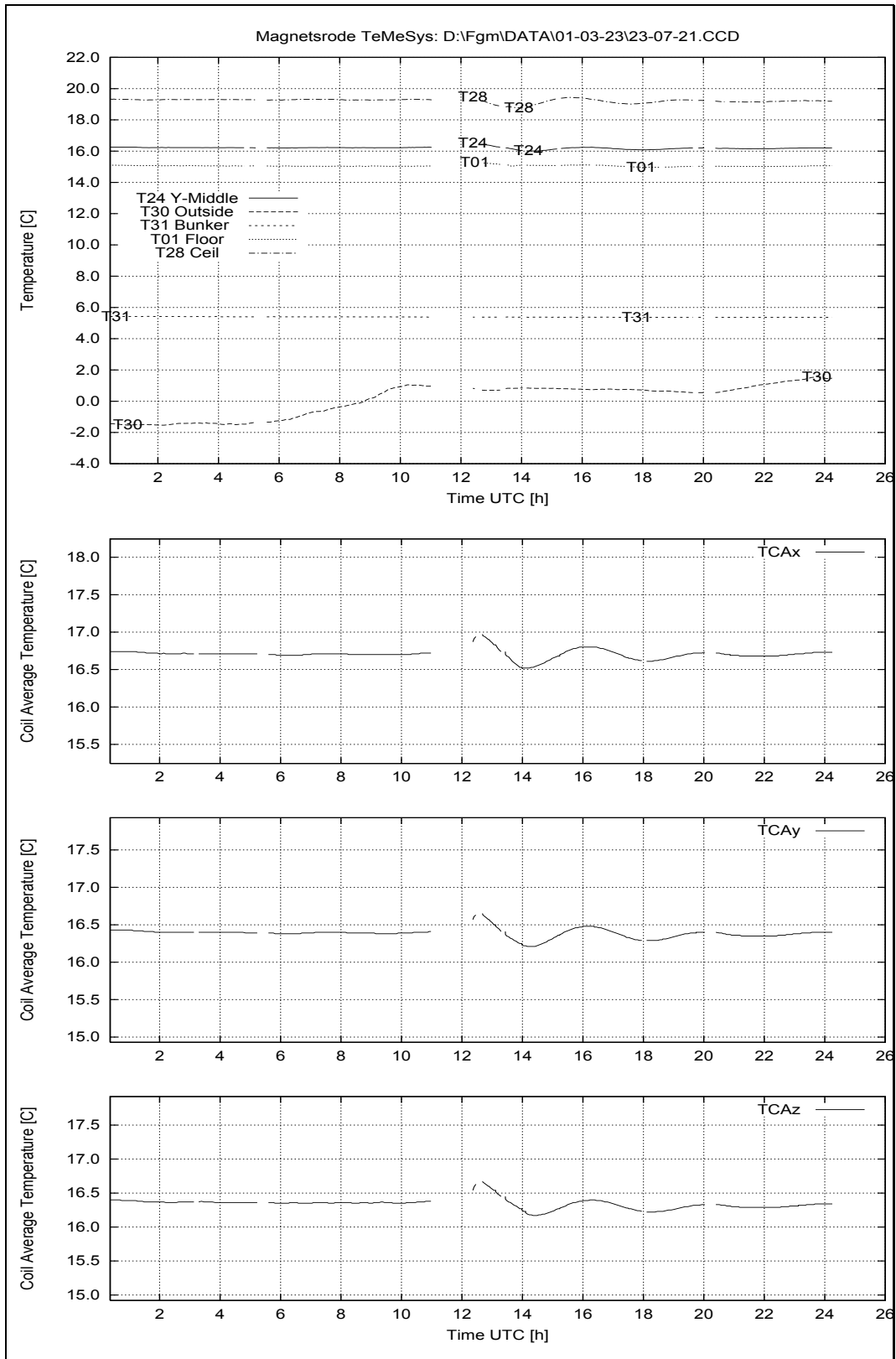

Figure 19: March 23, 2001: Temperatures House 2.

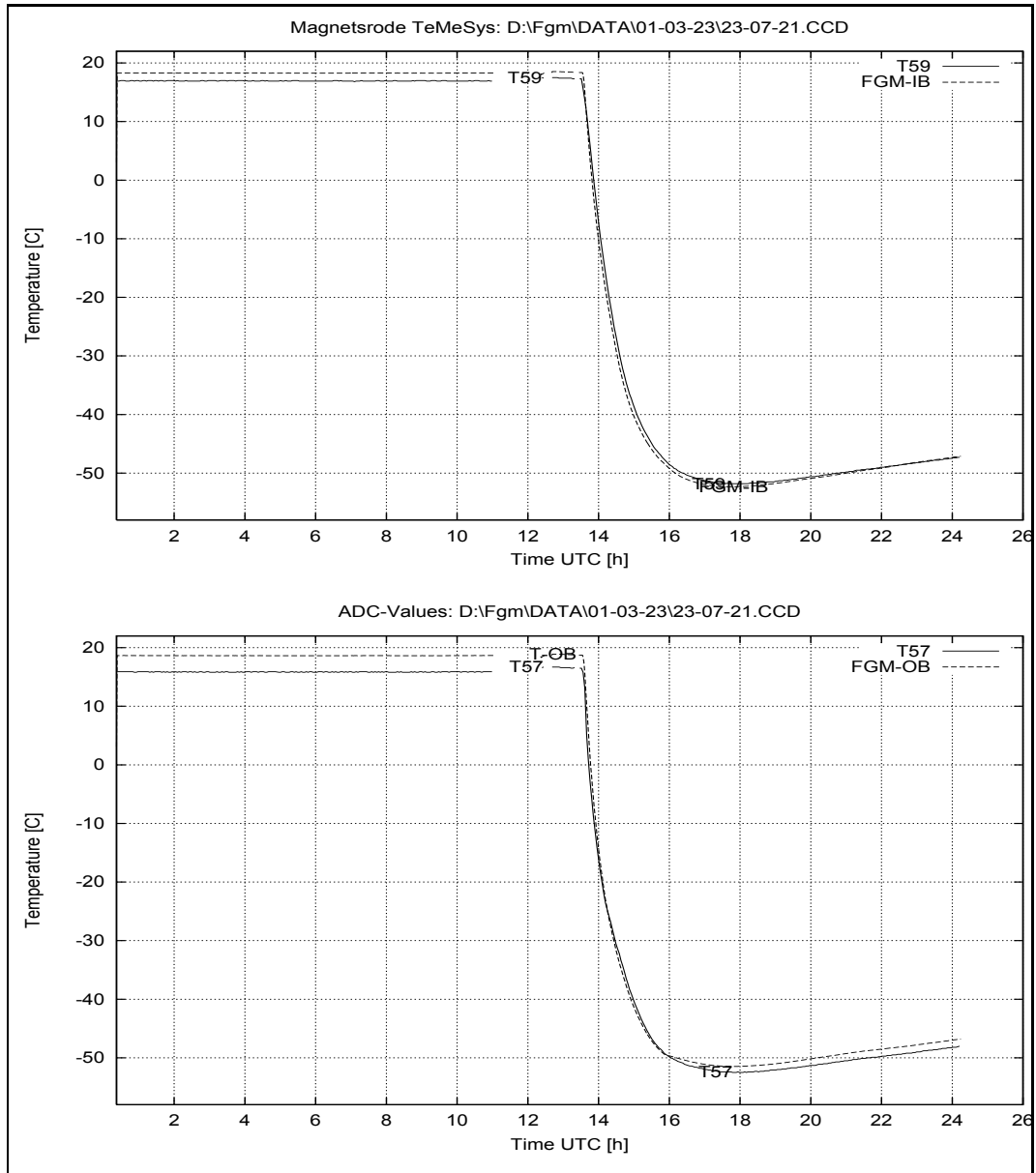

Figure 20: March 23, 2001: Sensor Temperatures at House 2.

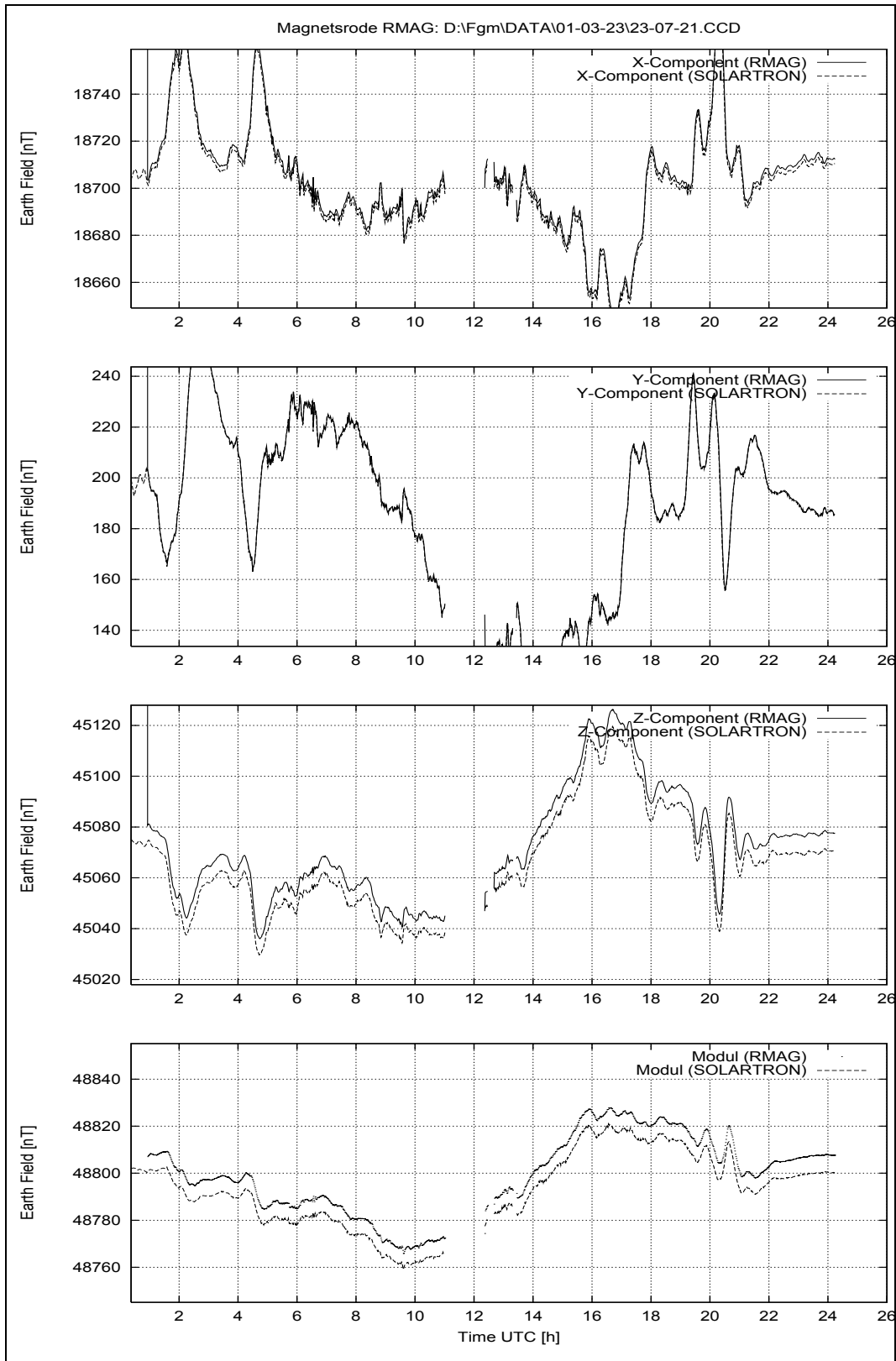

Figure 21: March 23, 2001: Earthfield variations.

R O S E T T A		Document: RO-IGM-TR-0002
		Issue: 2
		Revision: 2
IGM	Institut für Geophysik und Meteorologie	Date: October 10, 2001
	Technische Universität Braunschweig	Page: 37

7 Saturday March 24, 2001

7.1 Temperature Calibration, Cooling Cycle, FM Sensors, Continued

The cooling cycle goes on today without any problem. No personnel around today.

7.1.1 Data

Configuration File	CCD File	CCD File	Remark
TEMP.CFG	01-03-24\00_15_02.CCD	01-03-24\12_40_17.CCD	
TEMP.CFG	01-03-24\01_22_43.CCD	01-03-24\13_47_57.CCD	
TEMP.CFG	01-03-24\02_30_23.CCD	01-03-24\14_55_38.CCD	
TEMP.CFG	01-03-24\03_38_04.CCD	01-03-24\16_03_18.CCD	
TEMP.CFG	01-03-24\04_45_45.CCD	01-03-24\17_10_59.CCD	
TEMP.CFG	01-03-24\05_53_25.CCD	01-03-24\18_18_38.CCD	
TEMP.CFG	01-03-24\07_01_06.CCD	01-03-24\19_26_18.CCD	
TEMP.CFG	01-03-24\08_08_46.CCD	01-03-24\20_33_59.CCD	
TEMP.CFG	01-03-24\09_16_46.CCD	01-03-24\21_41_40.CCD	
TEMP.CFG	01-03-24\10_24_56.CCD	01-03-24\22_49_20.CCD	
TEMP.CFG	01-03-24\11_32_36.CCD	01-03-24\23_57_00.CCD	

7.2 Overview Plots: System Performance, Temperatures and Earthfield Variations.

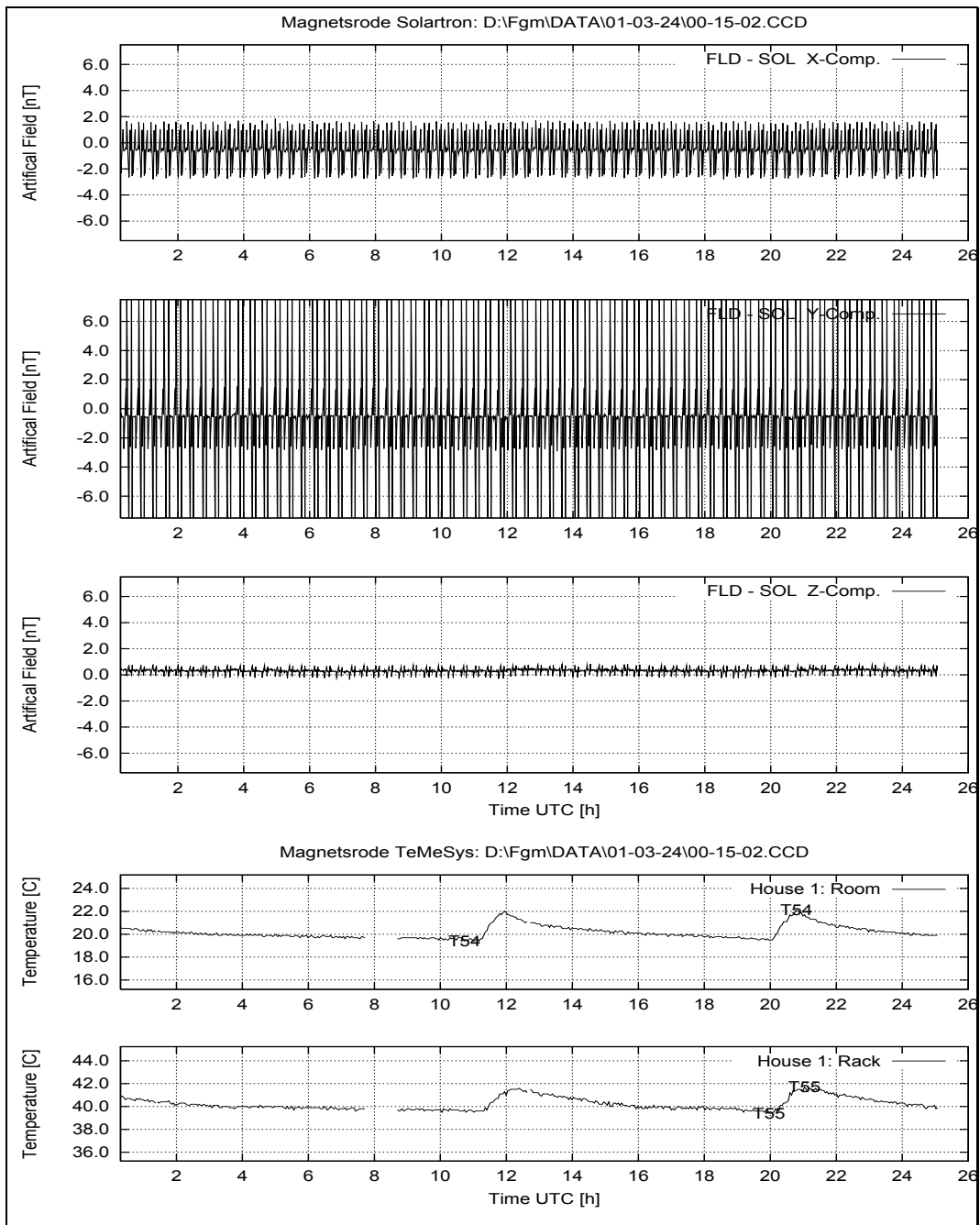

Figure 22: March 24, 2001: System Performance: FLD – SOL; Temperatures at House 1.

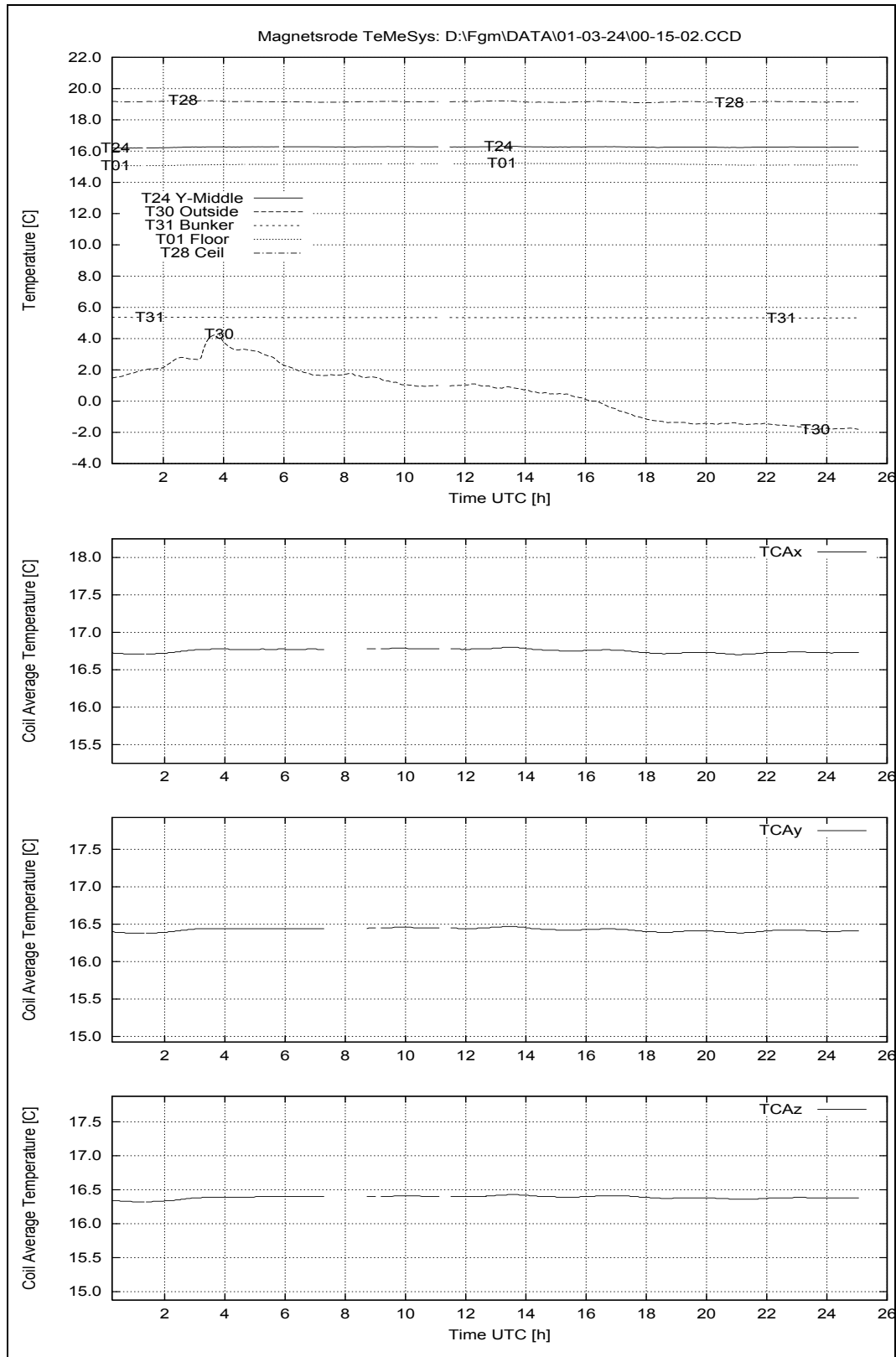

Figure 23: March 24, 2001: Temperatures House 2.

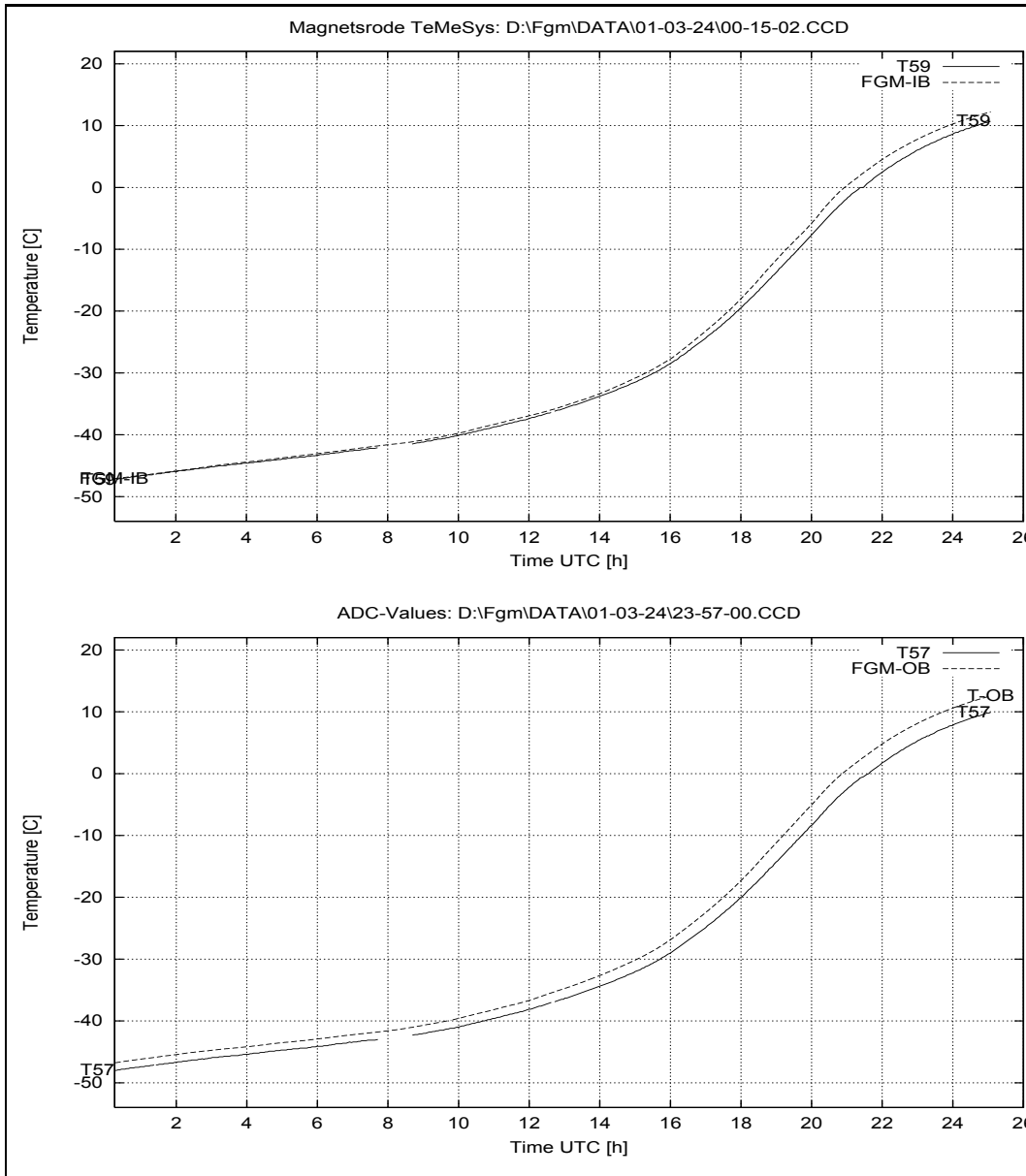

Figure 24: March 23, 2001: Sensor Temperatures at House 2.

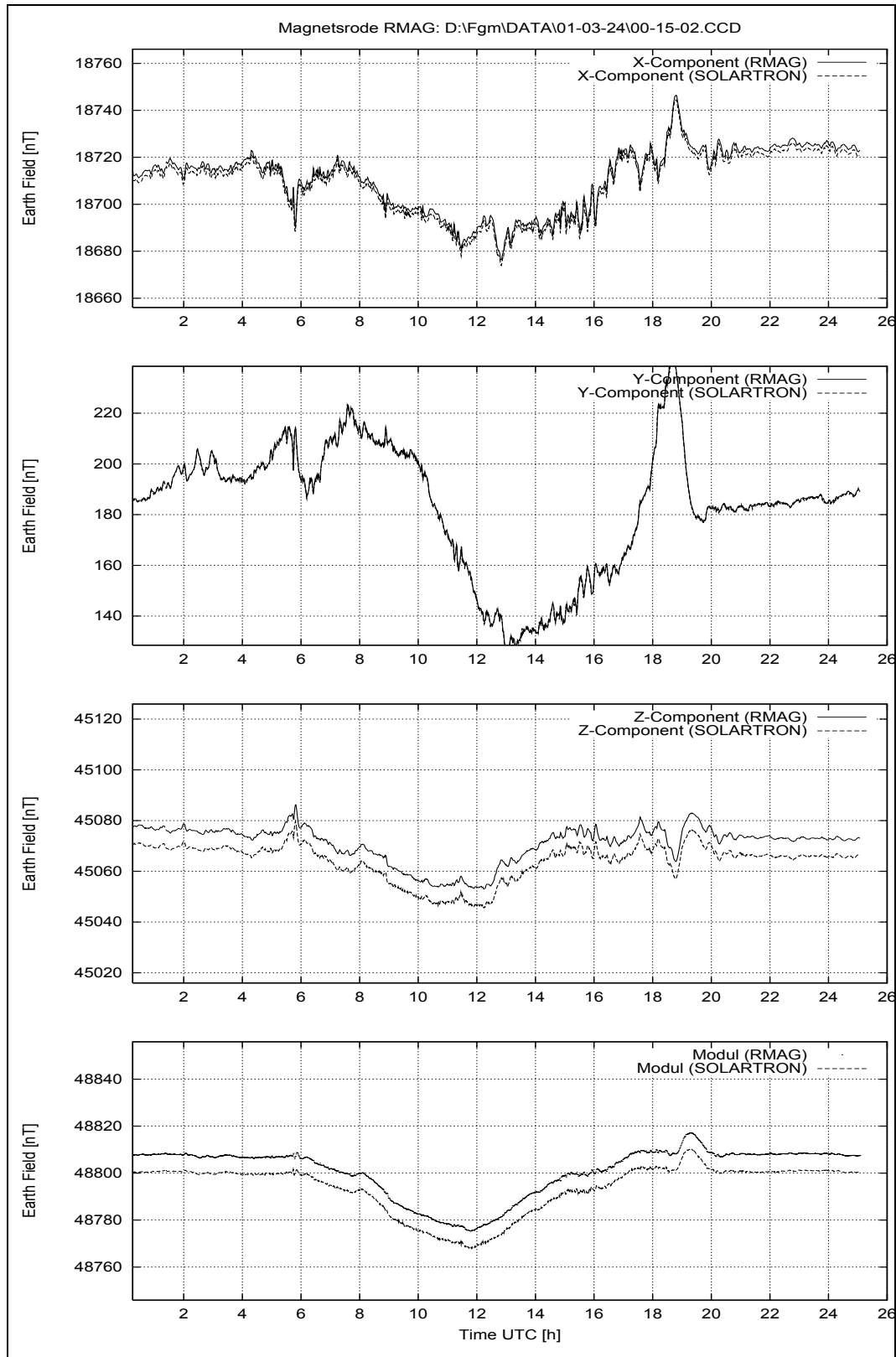

Figure 25: March 24, 2001: Earthfield variations.

R O S E T T A		Document: RO-IGM-TR-0002
		Issue: 2
		Revision: 2
IGM	Institut für Geophysik und Meteorologie Technische Universität Braunschweig	Date: October 10, 2001
		Page: 42

8 Sunday March 25, 2001

8.1 Temperature Calibration, Heating Cycle, FM Sensors

The cooling cycle ended in the early morning hours. At reaching +10° the heating cycle started automatically as TEMPCTRL was in AUTOMATIC running mode. The processed temperature profil was ROSSETTA1.CUR

Due to a loose contact at the heating foils inside the thermobox the system did not heat up although the TEMPCTRL s/w worked properly. The failure was detected in the afternoon. Therefore the system was stopped at 14:36. After the successful executed contingency recovery procedure (connecting the loose heater power line to the heater foil) the heating cycle ran without any problems. Also TEMPCTRL was restarted.

File: T_2.SEQ

Restart : 14:45:21

8.1.1 Data

Configuration File	CCD File	CCD File	Remark
TEMP.CFG	01-03-25\01_04_41.CCD	01-03-25\12_21_25.CCD	
TEMP.CFG	01-03-25\02_12_20.CCD	01-03-25\13_29_06.CCD	
TEMP.CFG	01-03-25\03_20_02.CCD	01-03-25\14_45_21.CCD	
TEMP.CFG	01-03-25\04_27_43.CCD	01-03-25\15_53_01.CCD	
TEMP.CFG	01-03-25\05_35_23.CCD	01-03-25\17_00_41.CCD	
TEMP.CFG	01-03-25\06_43_03.CCD	01-03-25\18_08_22.CCD	
TEMP.CFG	01-03-25\07_50_44.CCD	01-03-25\19_16_02.CCD	
TEMP.CFG	01-03-25\08_58_24.CCD	01-03-25\20_23_42.CCD	
TEMP.CFG	01-03-25\10_06_05.CCD	01-03-25\21_31_23.CCD	
TEMP.CFG	01-03-25\11_13_44.CCD	01-03-25\22_39_04.CCD	
TEMP.CFG		01-03-25\23_46_45.CCD	

8.2 Overview Plots: System Performance, Temperatures and Earthfield Variations.

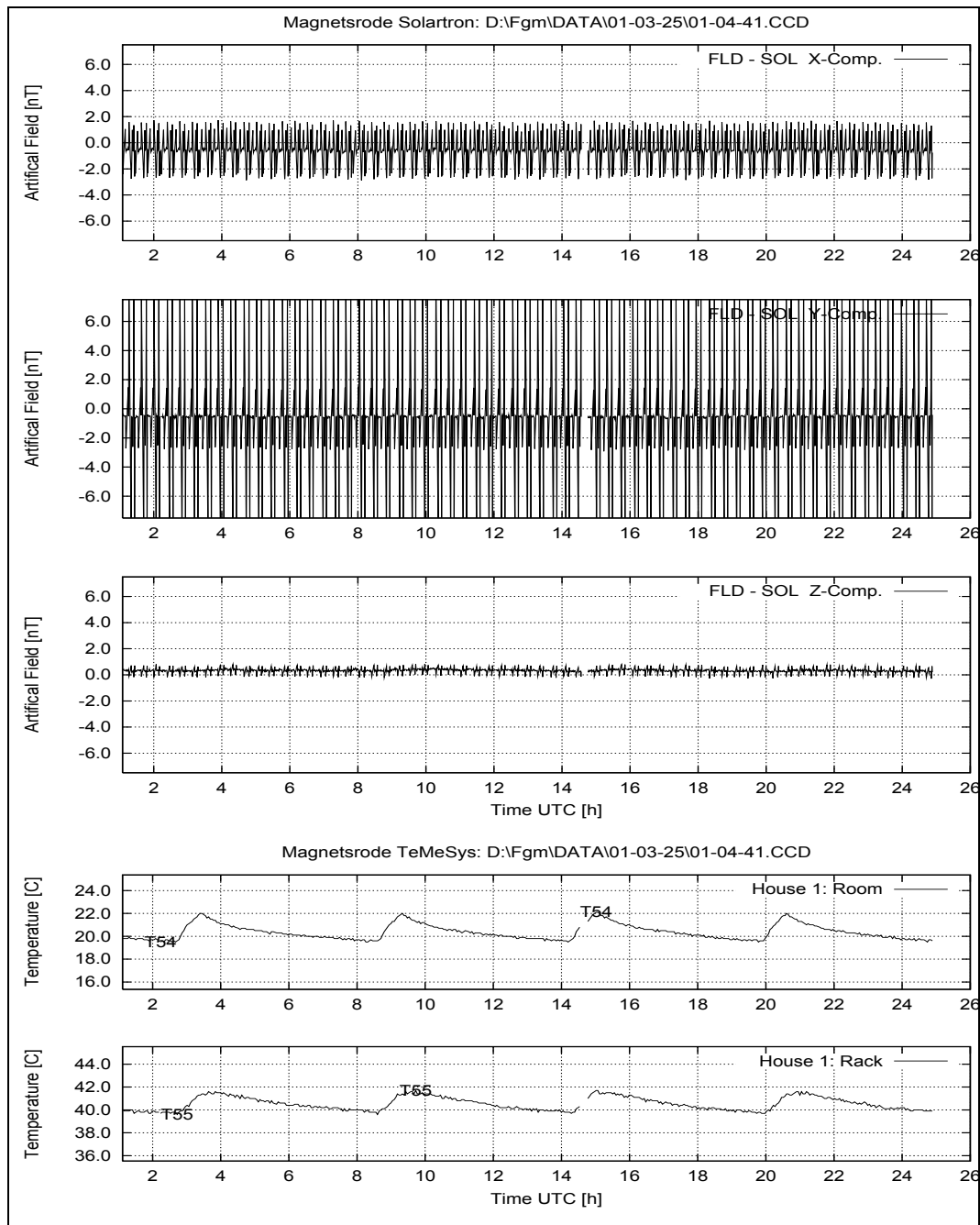

Figure 26: March 25, 2001: System Performance: FLD – SOL; Temperatures at House 1.

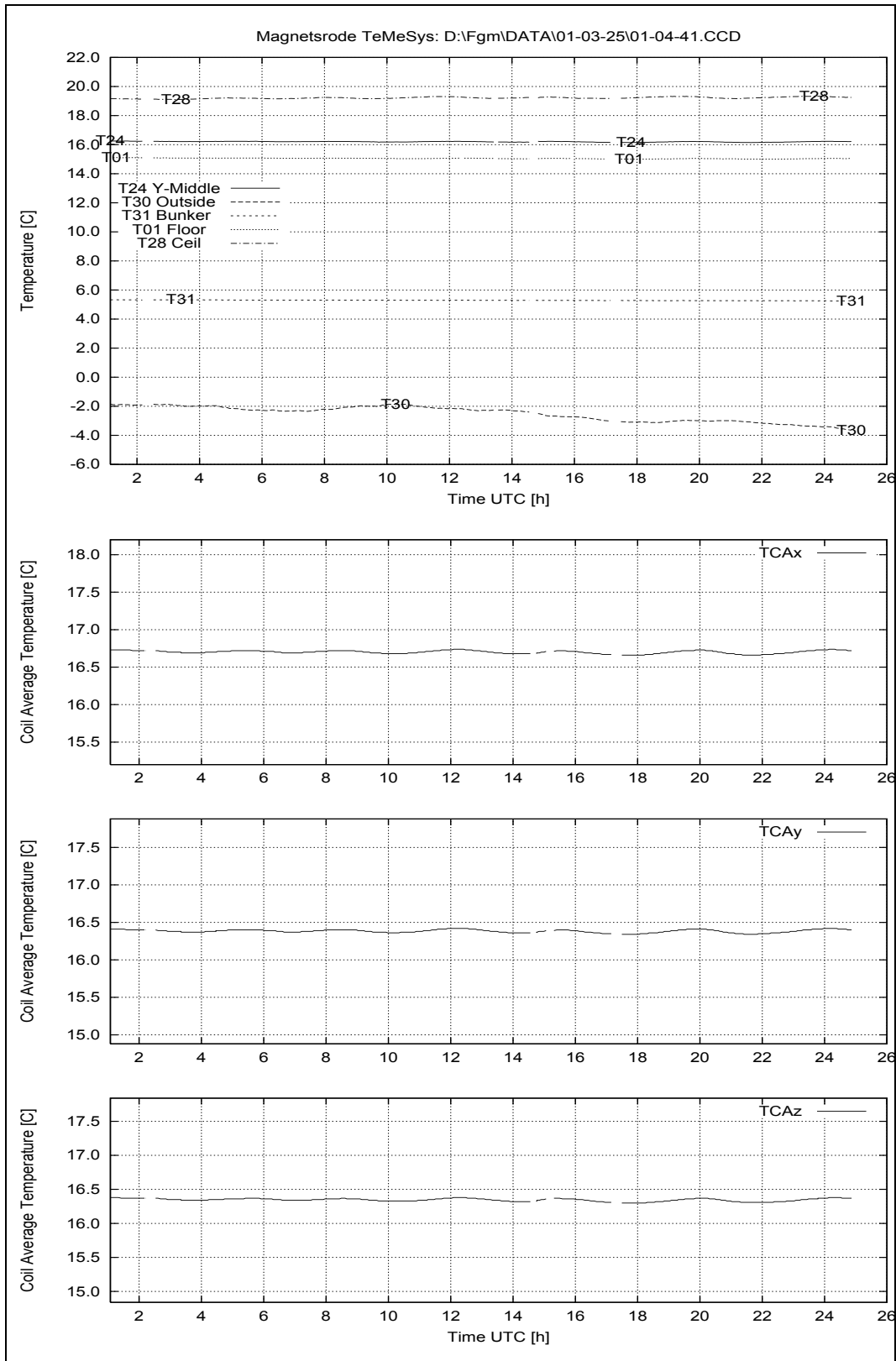

Figure 27: March 25, 2001: Temperatures House 2.

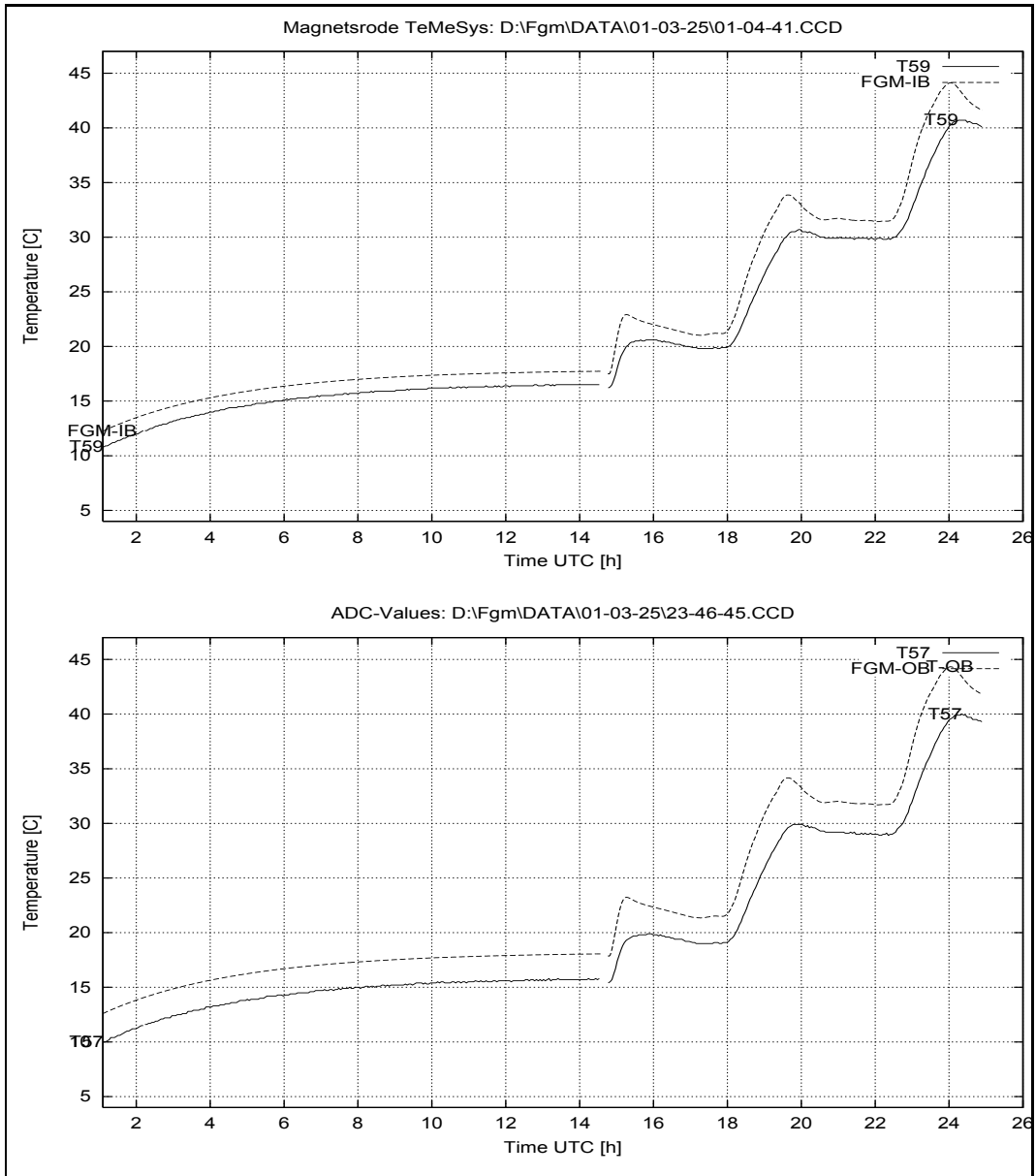

Figure 28: March 25, 2001: Sensor Temperatures at House 2.

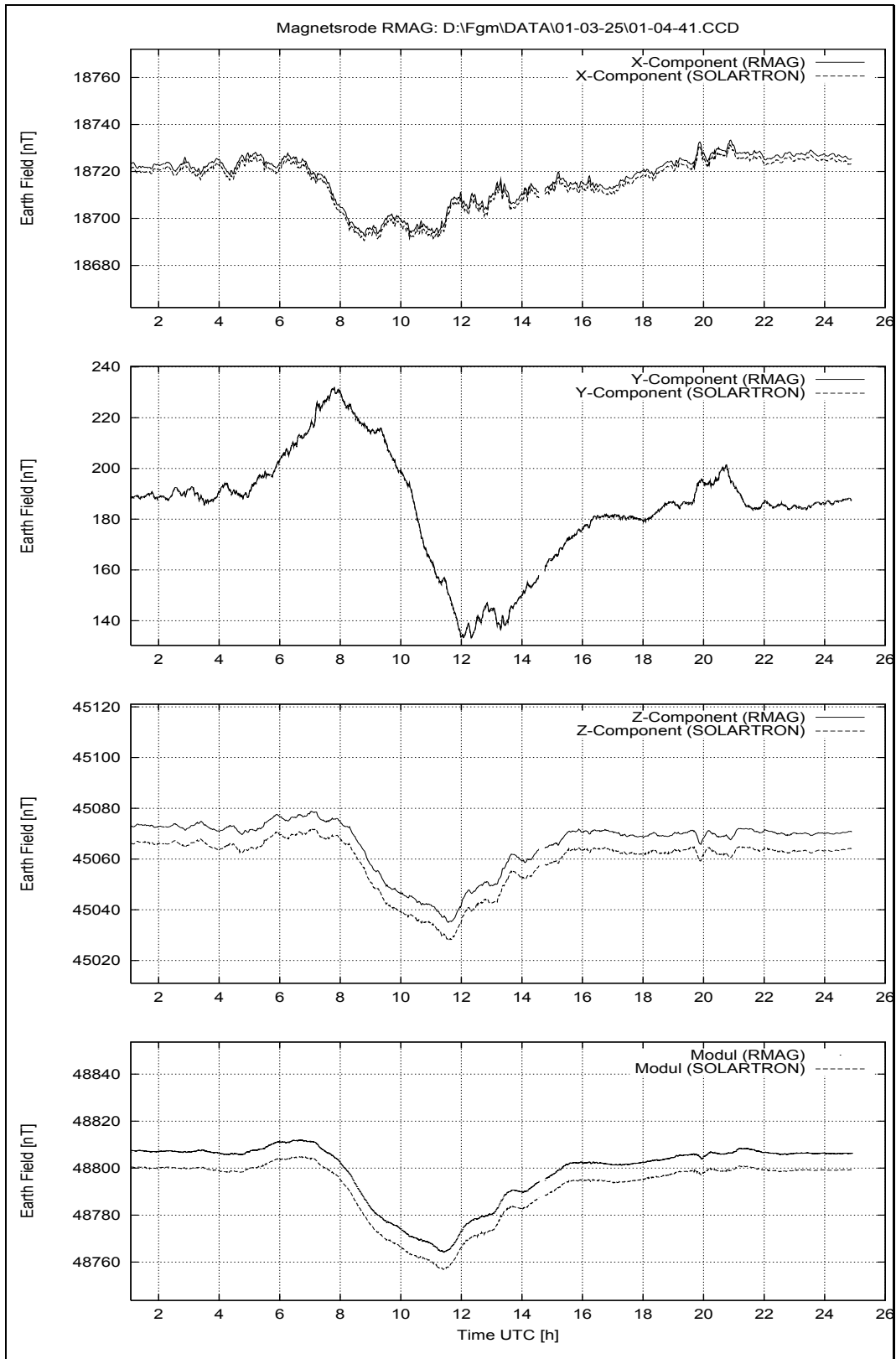

Figure 29: March 25, 2001: Earthfield variations.

R O S E T T A		Document: RO-IGM-TR-0002
IGM Institut für Geophysik und Meteorologie Technische Universität Braunschweig		Issue: 2
		Revision: 2
		Date: October 10, 2001
		Page: 47

9 Monday March 26, 2001

9.1 Temperature Calibration, Heating Cycle, FM Sensors, Continued

The heating cycle did go on without any problems. No personnel around on this day.

9.1.1 Data

Configuration File	CCD File	CCD File	Remark
TEMP.CFG	01-03-26\00_54_26.CCD	01-03-26\13_19_10.CCD	
TEMP.CFG	01-03-26\02_02_06.CCD	01-03-26\14_26_51.CCD	
TEMP.CFG	01-03-26\03_09_46.CCD	01-03-26\15_34_32.CCD	
TEMP.CFG	01-03-26\04_17_27.CCD	01-03-26\16_42_12.CCD	
TEMP.CFG	01-03-26\05_25_28.CCD	01-03-26\17_49_53.CCD	
TEMP.CFG	01-03-26\06_33_08.CCD	01-03-26\18_57_34.CCD	
TEMP.CFG	01-03-26\07_40_49.CCD	01-03-26\20_05_15.CCD	
TEMP.CFG	01-03-26\08_48_29.CCD	01-03-26\21_12_54.CCD	
TEMP.CFG	01-03-26\09_56_08.CCD	01-03-26\22_20_35.CCD	
TEMP.CFG	01-03-26\11_03_49.CCD	01-03-26\23_28_15.CCD	
TEMP.CFG	01-03-26\12_11_29.CCD		

9.2 Overview Plots: System Performance, Temperatures and Earthfield Variations.

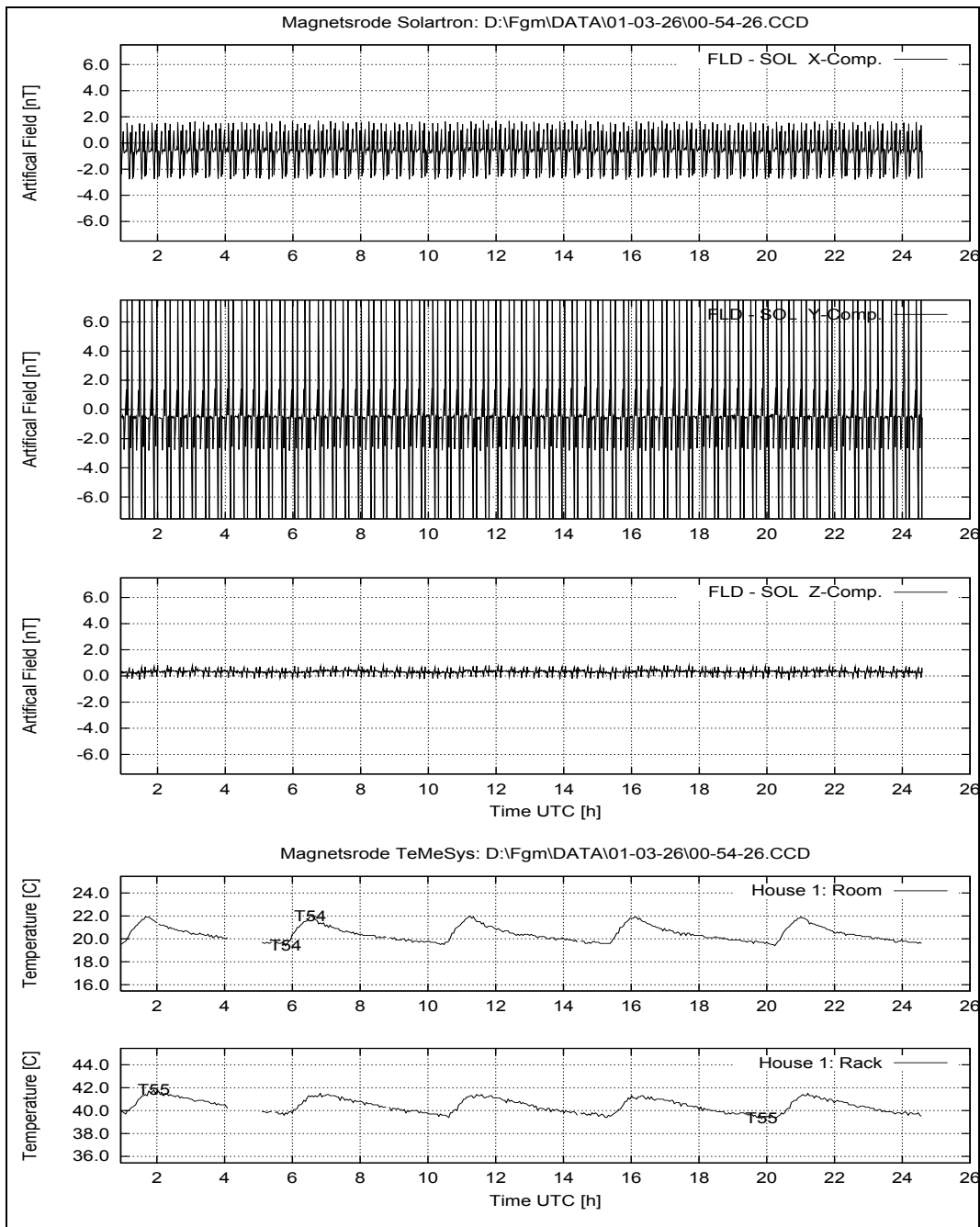

Figure 30: March 26, 2001: System Performance: FLD – SOL; Temperatures at House 1.

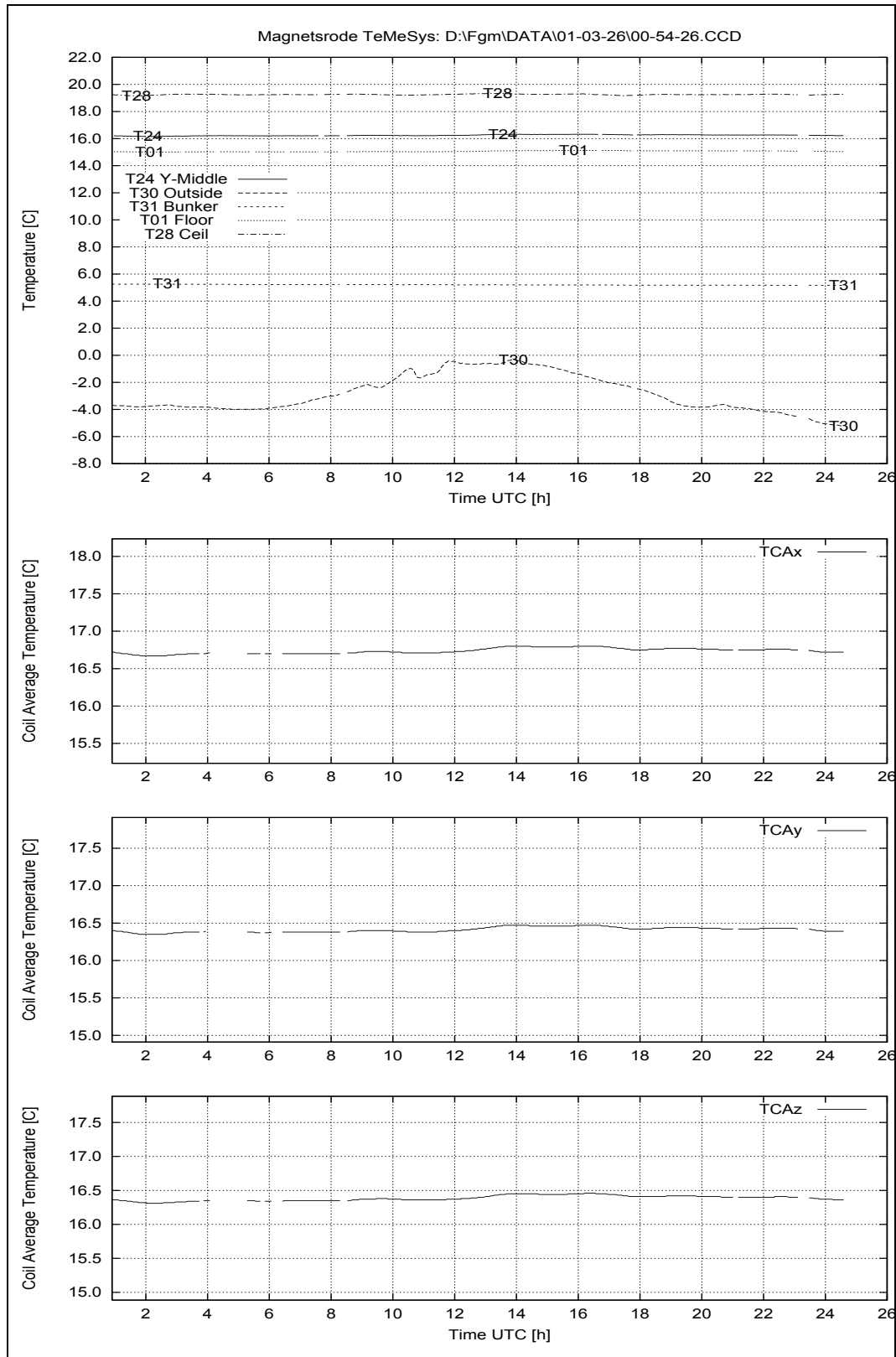

Figure 31: March 26, 2001: Temperatures House 2.

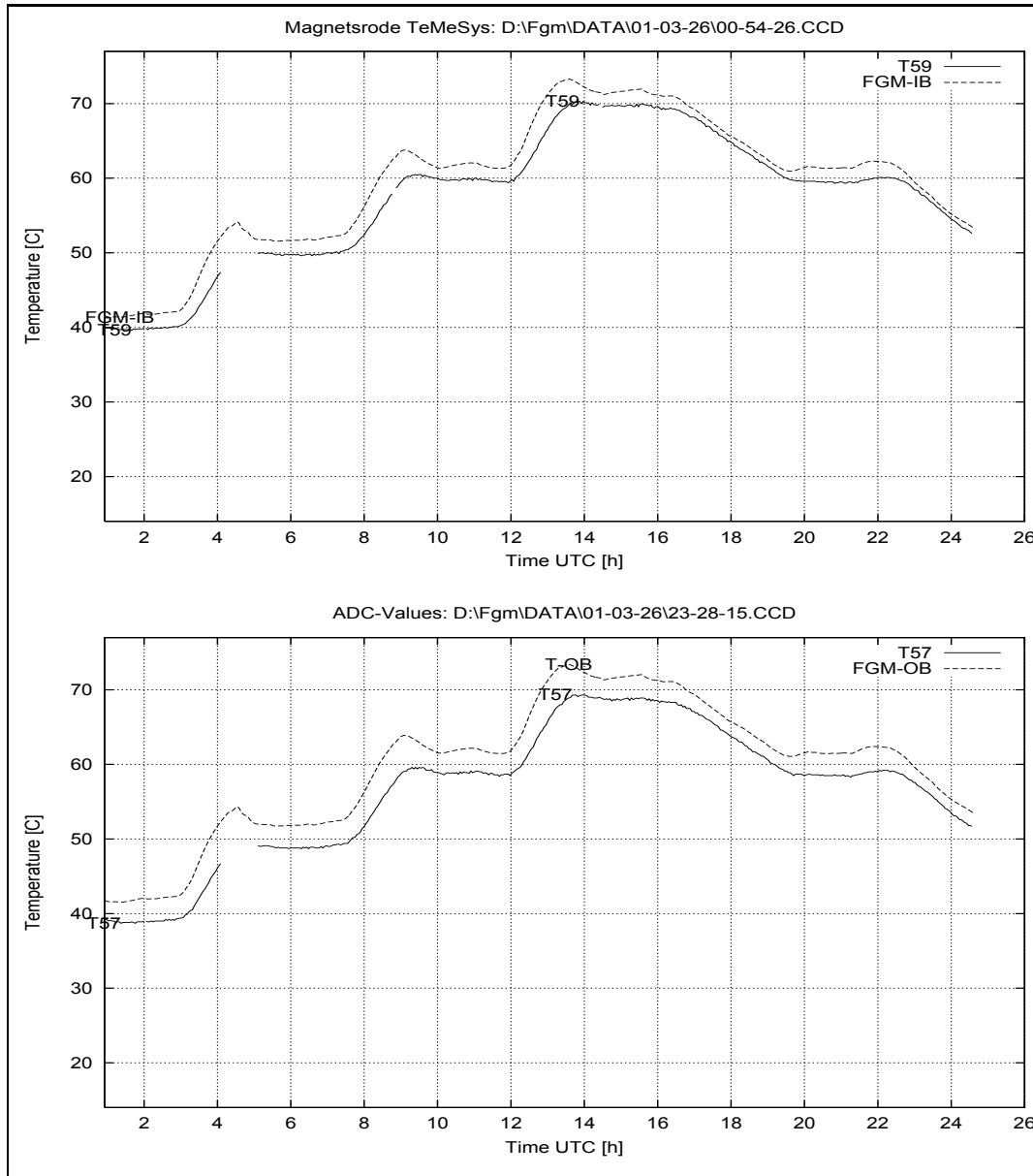

Figure 32: March 26, 2001: Sensor Temperatures at House 2.

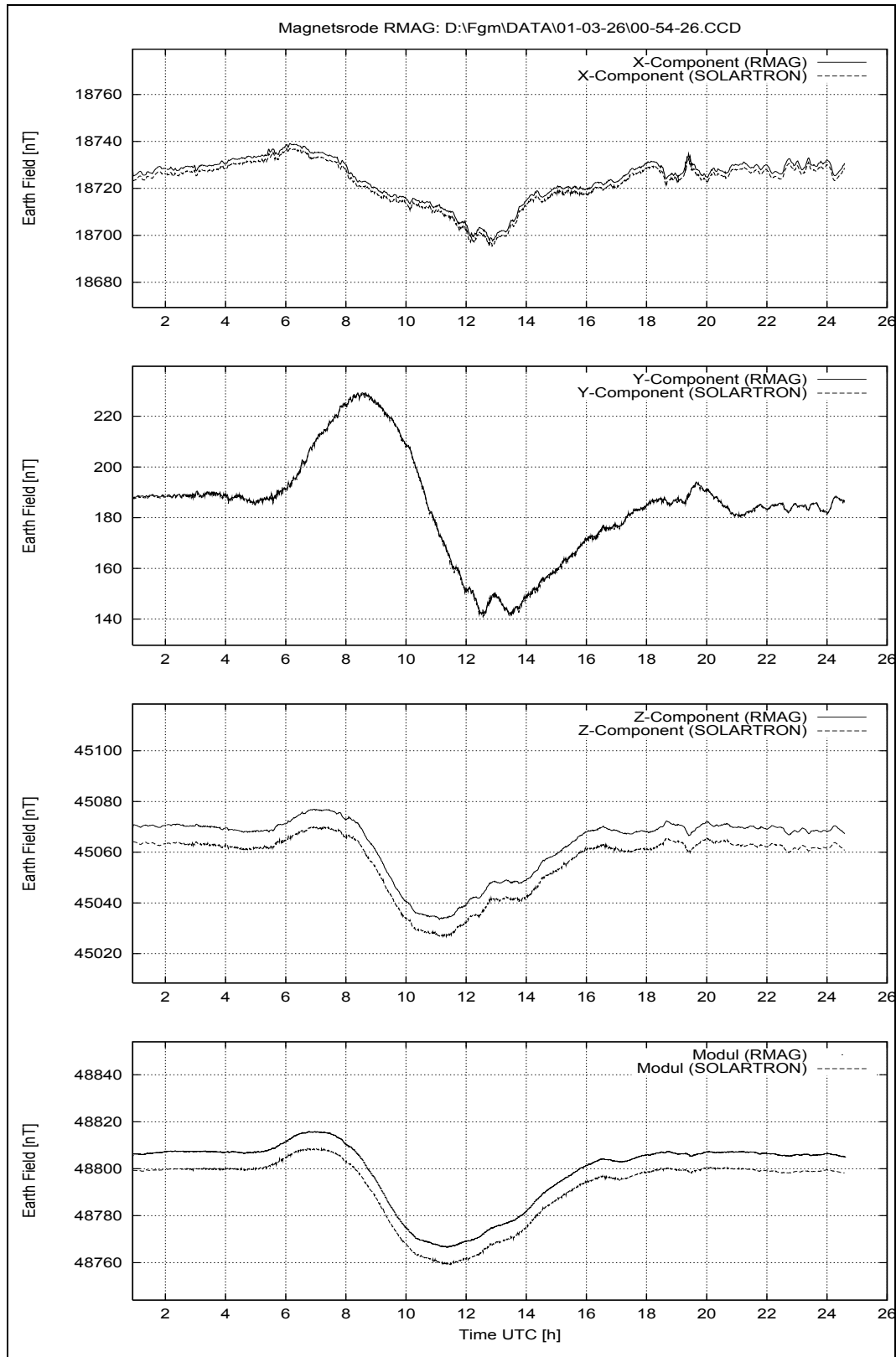

Figure 33: March 26, 2001: Earthfield variations.

R O S E T T A		Document: RO-IGM-TR-0002
		Issue: 2
		Revision: 2
IGM	Institut für Geophysik und Meteorologie	Date: October 10, 2001
	Technische Universität Braunschweig	Page: 52

10 Tuesday March 27, 2001

10.1 Temperature Calibration, Heating Cycle, FM Sensors, Continued

The heating cycle did go on without any problems. No personnel around on this day.

10.1.1 Data

Configuration File	CCD File	CCD File	Remark
TEMP.CFG	01-03-27\00_36_28.CCD	01-03-27\13_00_55.CCD	
TEMP.CFG	01-03-27\01_44_09.CCD	01-03-27\14_08_35.CCD	
TEMP.CFG	01-03-27\02_51_49.CCD	01-03-27\15_16_15.CCD	
TEMP.CFG	01-03-27\03_59_29.CCD	01-03-27\16_23_55.CCD	
TEMP.CFG	01-03-27\05_07_10.CCD	01-03-27\17_31_36.CCD	
TEMP.CFG	01-03-27\06_14_51.CCD	01-03-27\18_39_17.CCD	
TEMP.CFG	01-03-27\07_22_32.CCD	01-03-27\19_46_57.CCD	
TEMP.CFG	01-03-27\08_30_12.CCD	01-03-27\20_54_36.CCD	
TEMP.CFG	01-03-27\09_37_52.CCD	01-03-27\22_02_17.CCD	
TEMP.CFG	01-03-27\10_45_33.CCD	01-03-27\23_09_57.CCD	
TEMP.CFG	01-03-27\11_53_14.CCD		

10.2 Overview Plots: System Performance, Temperatures and Earth-field Variations.

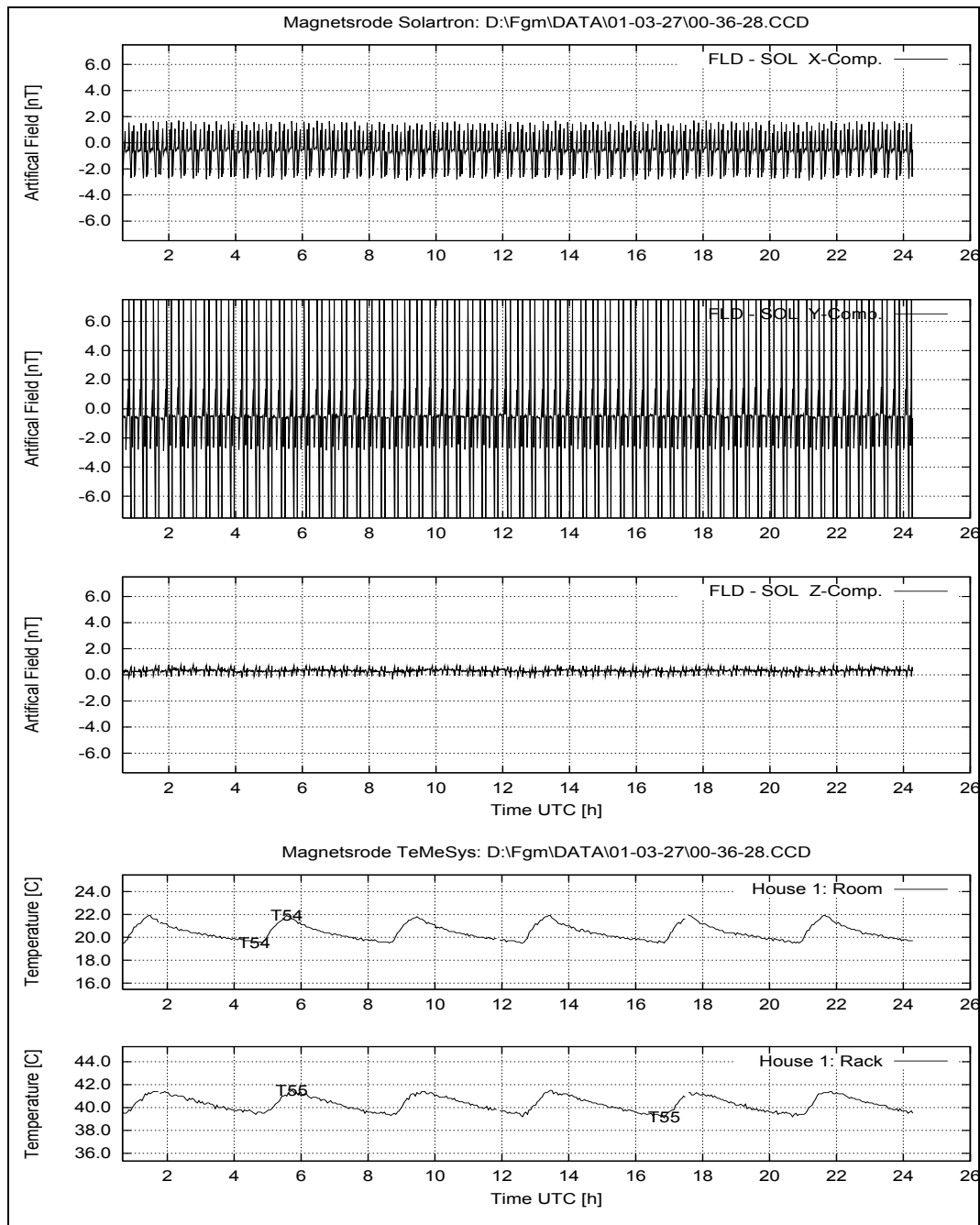

Figure 34: March 27, 2001: System Performance: FLD – SOL; Temperatures at House 1.

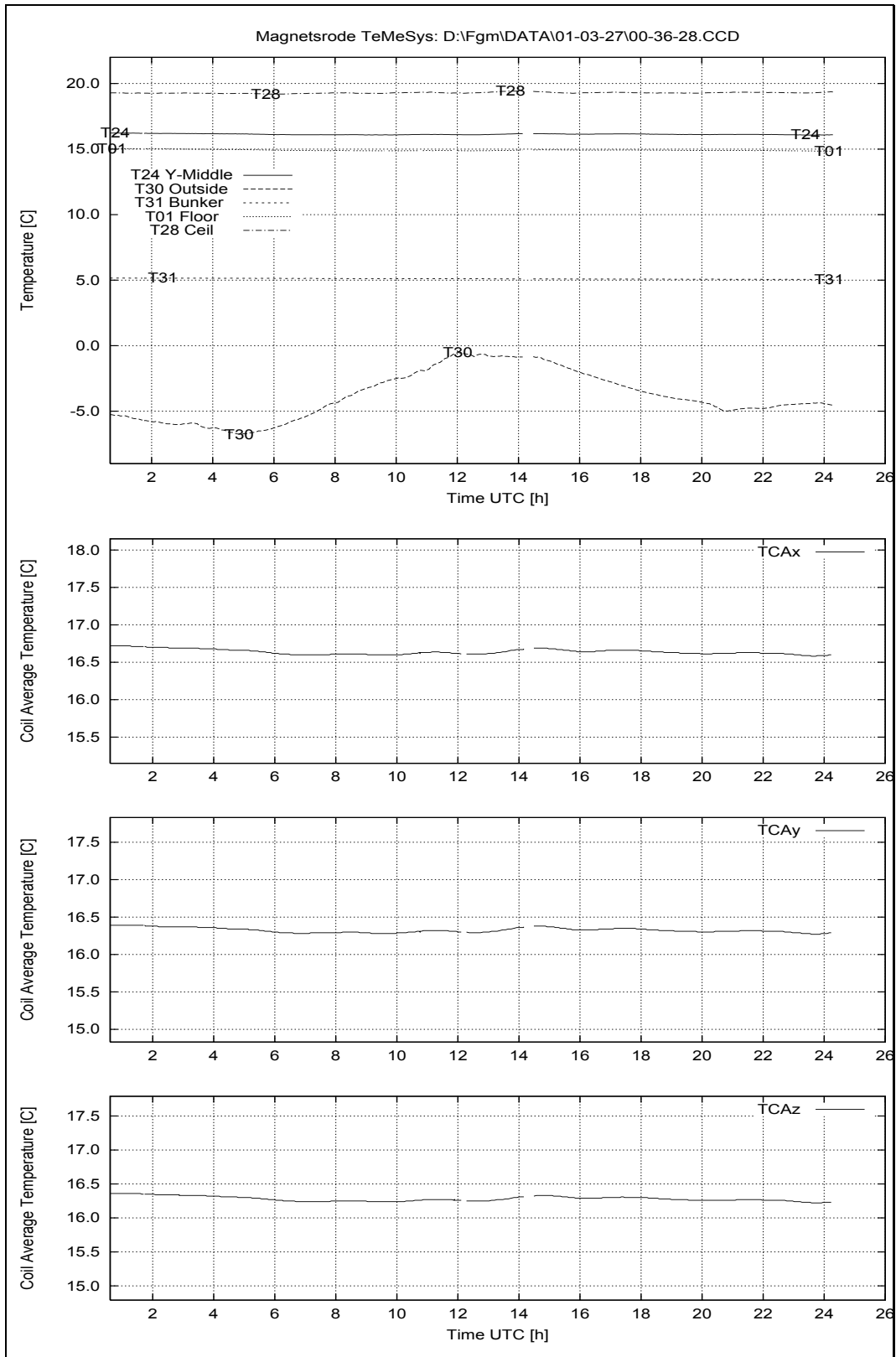

Figure 35: March 27, 2001: Temperatures House 2.

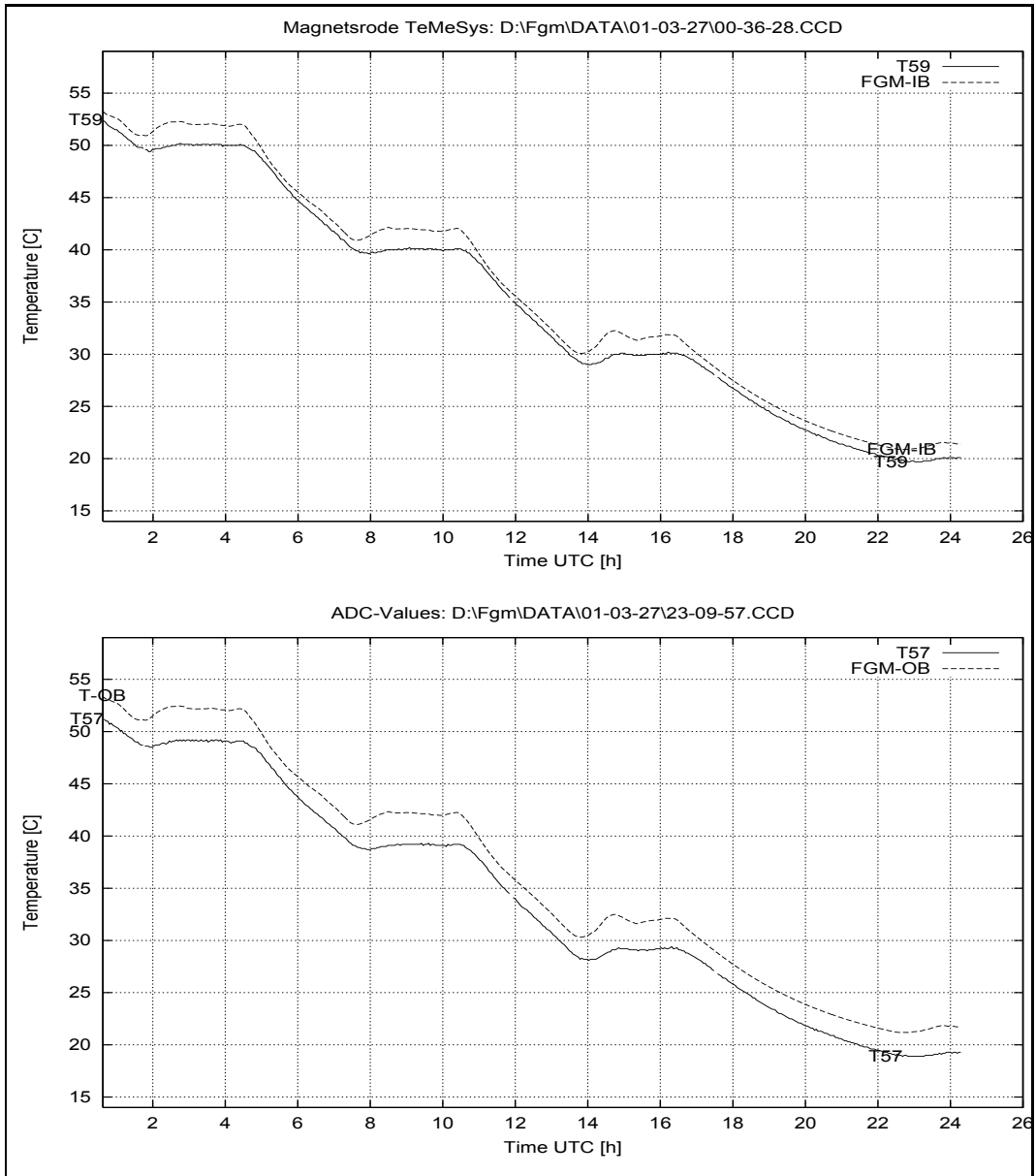

Figure 36: March 27, 2001: Sensor Temperatures at House 2.

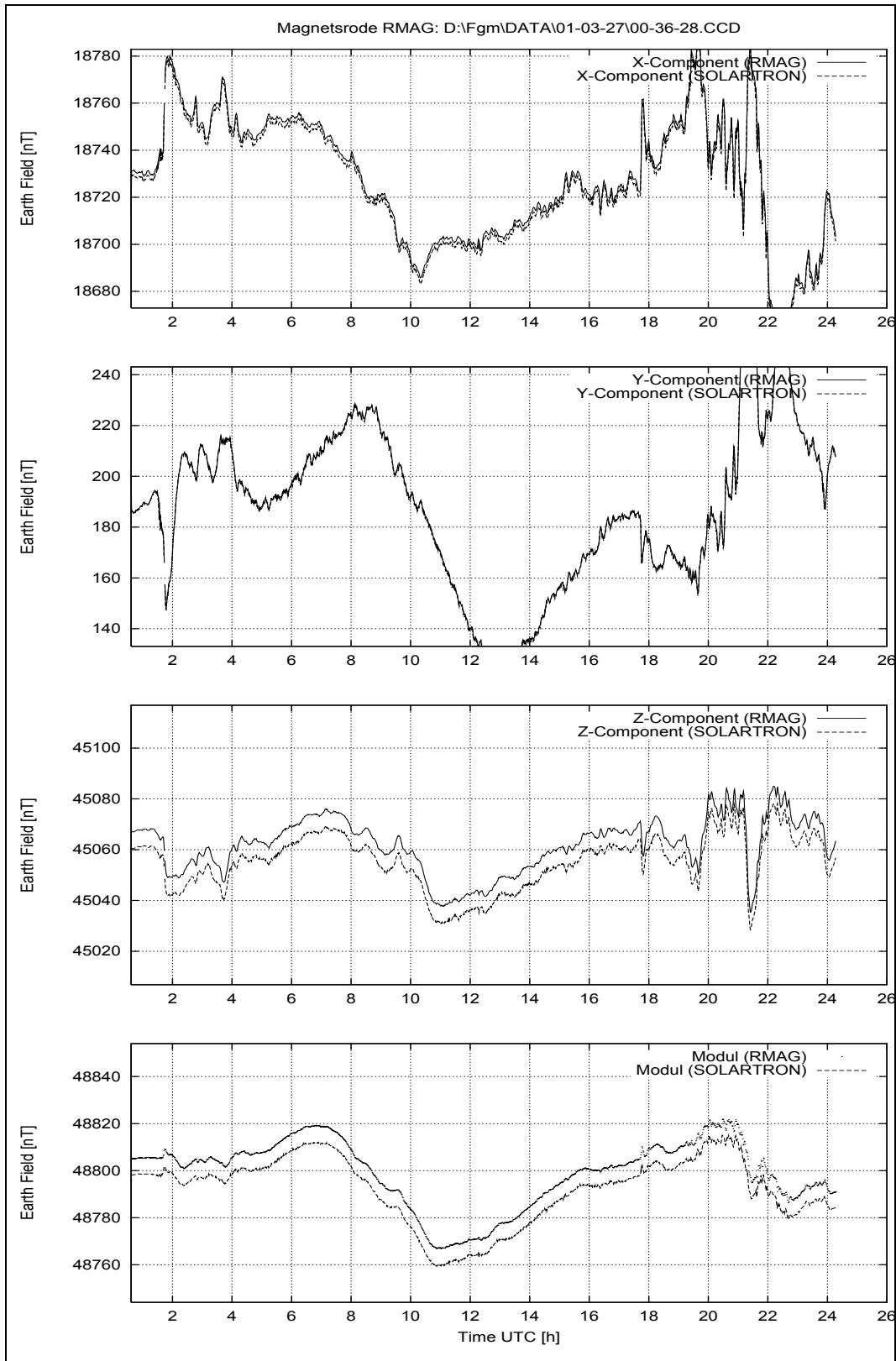

Figure 37: March 27, 2001: Earthfield variations.

R O S E T T A		Document: RO-IGM-TR-0002
		Issue: 2
		Revision: 2
IGM	Institut für Geophysik und Meteorologie	Date: October 10, 2001
	Technische Universität Braunschweig	Page: 57

11 Wednesday March 28, 2001

11.1 Temperature Calibration, Heating Cycle, FM Sensors, Continued

The heating cycle has been finished in the morning hours. The measurements have been stopped with ESC on the MR0DE controller.

Afterwards the linearity measurements after the T-Cycle have been performed.

11.1.1 Data

Configuration File	CCD File	CCD File	Remark
TEMP.CFG	01-03-28\00_17_38.CCD	01-03-28\04_48_44.CCD	
TEMP.CFG	01-03-28\01_25_17.CCD	01-03-28\05_56_26.CCD	
TEMP.CFG	01-03-28\02_32_59.CCD	01-03-28\07_04_05.CCD	
TEMP.CFG	01-03-28\03_40_40.CCD	01-03-28\08_11_46.CCD	

11.2 Temperature Cycle, Linearities, FM Sensors

After the temperature calibration has finished some linearity measurements should be executed in the chosen setup of the temperature cycle. The sensors are still fixed and the box has not been touched.

Purpose: Measure the linearity of the FGM sensors.
Conditions: FM-OB and FM-IB placed in the Thermal Test Box on the aluminium support. The distance between them is 150 mm.
MAD: Ch0 to Ch2 connected to Zopfmag x to z, 10 nT/mV;
Ch7 FSP;
Timer 500, SumUp 100, Vectorrate 1.00 Hz.
Files: T_LIN.SEQ
Start: 28.03.01 08:56
End: 28.03.01 09:45

11.2.1 Data

Configuration File	CCD File
ali10.CFG	01-03-28\08_56_45.CCD
TX15.CFG	01-03-28\09_03_55.CCD
TY15.CFG	01-03-28\09_16_55.CCD
TZ15.CFG	01-03-28\09_29_55.CCD

R O S E T T A		Document: RO-IGM-TR-0002
		Issue: 2
		Revision: 2
IGM	Institut für Geophysik und Meteorologie Technische Universität Braunschweig	Date: October 10, 2001
		Page: 58

11.3 Earth Field Variation Check. DPU: FM, Sensors: FM-IB & FM-OB

The check is designed to investigate the regular registration of the two FGM sensors. The sensors are placed and fixed on the aluminium support inside the thermal test box (They have not been touched since closing the box after filling in the dry ice on Friday, 23rd. The distance between them is 15 cm.

Purpose: Earth field variation check.
Conditions: FM-OB and FM-IB placed in the Thermal Test Box on the aluminium support. The distance between them is 150 mm.
MAD: Ch0 to Ch2 connected to Zopfmag x to z, 10 nT/mV;
Ch7 FSP;
File: VAR_SEQ.CFG
Start: 28.03.01 18:21
End: 29.03.01 15:17 ESC

11.3.1 Data

Configuration File	CCD File	CCD File	Remarks
ali10.CFG	01-03-28\09_51_44.CCD		
VAR.CFG	01-03-28\09_58_54.CCD	01-03-28\17_03_42.CCD	
VAR.CFG	01-03-28\10_59_36.CCD	01-03-28\18_04_22.CCD	
VAR.CFG	01-03-28\12_00_18.CCD	01-03-28\19_05_03.CCD	
VAR.CFG	01-03-28\13_00_59.CCD	01-03-28\20_05_44.CCD	
VAR.CFG	01-03-28\14_01_40.CCD	01-03-28\21_06_24.CCD	
VAR.CFG	01-03-28\15_02_20.CCD	01-03-28\22_07_05.CCD	
VAR.CFG	01-03-28\16_03_01.CCD	01-03-28\23_07_46.CCD	

11.4 Overview Plots: System Performance, Temperatures and Earth-field Variations.

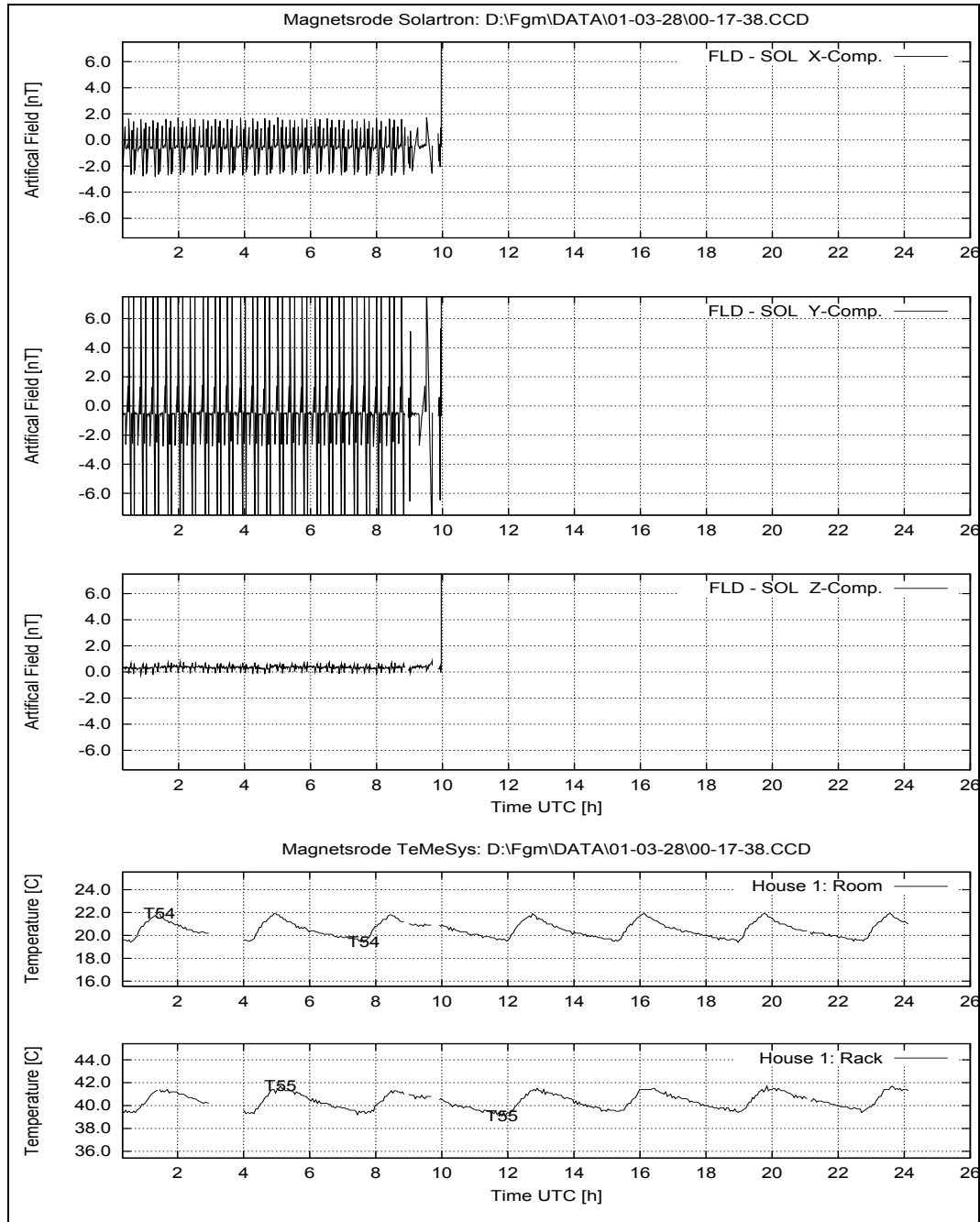

Figure 38: March 28, 2001: System Performance: FLD – SOL; Temperatures at House 1.

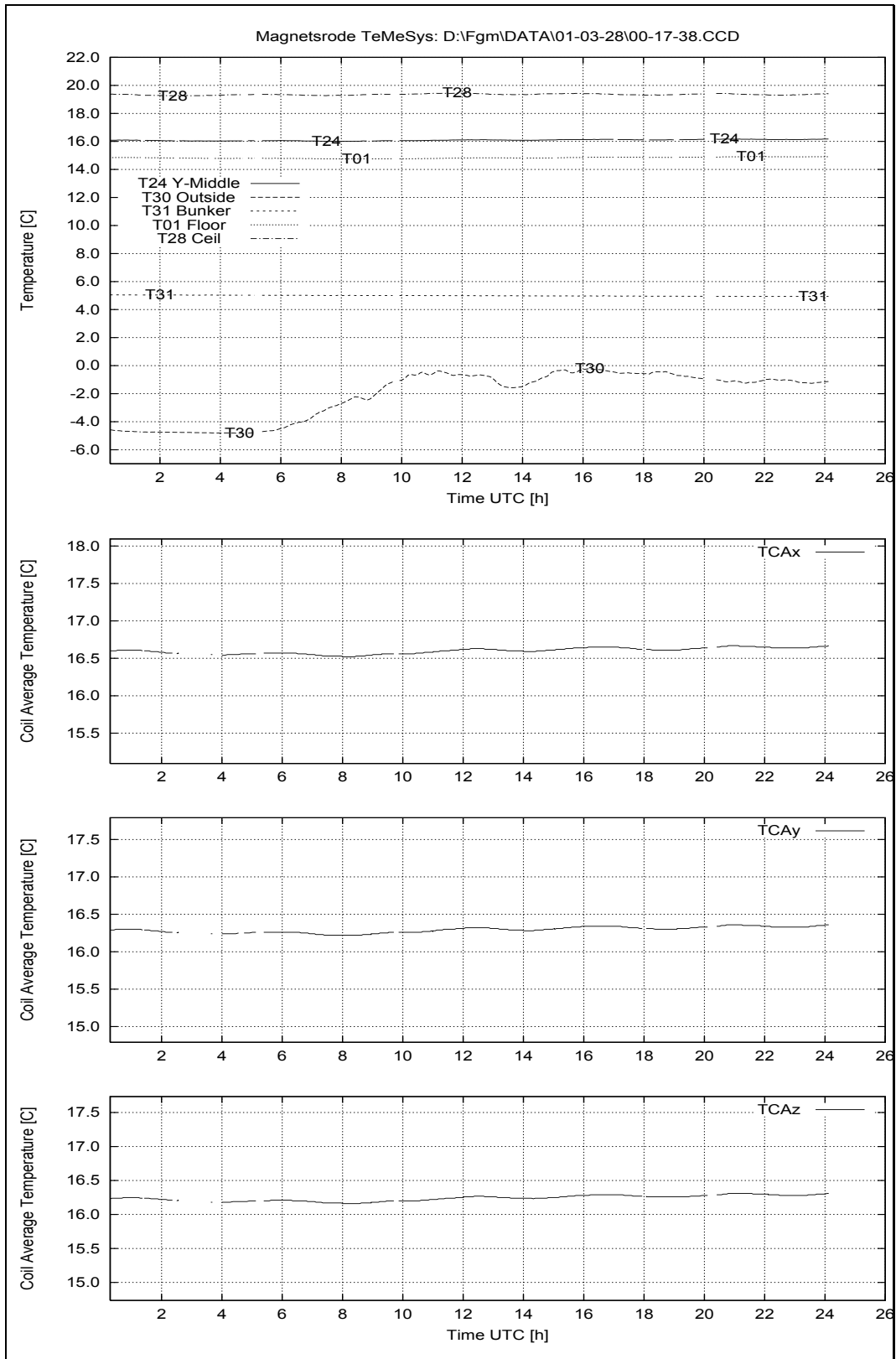

Figure 39: March 28, 2001: Temperatures House 2.

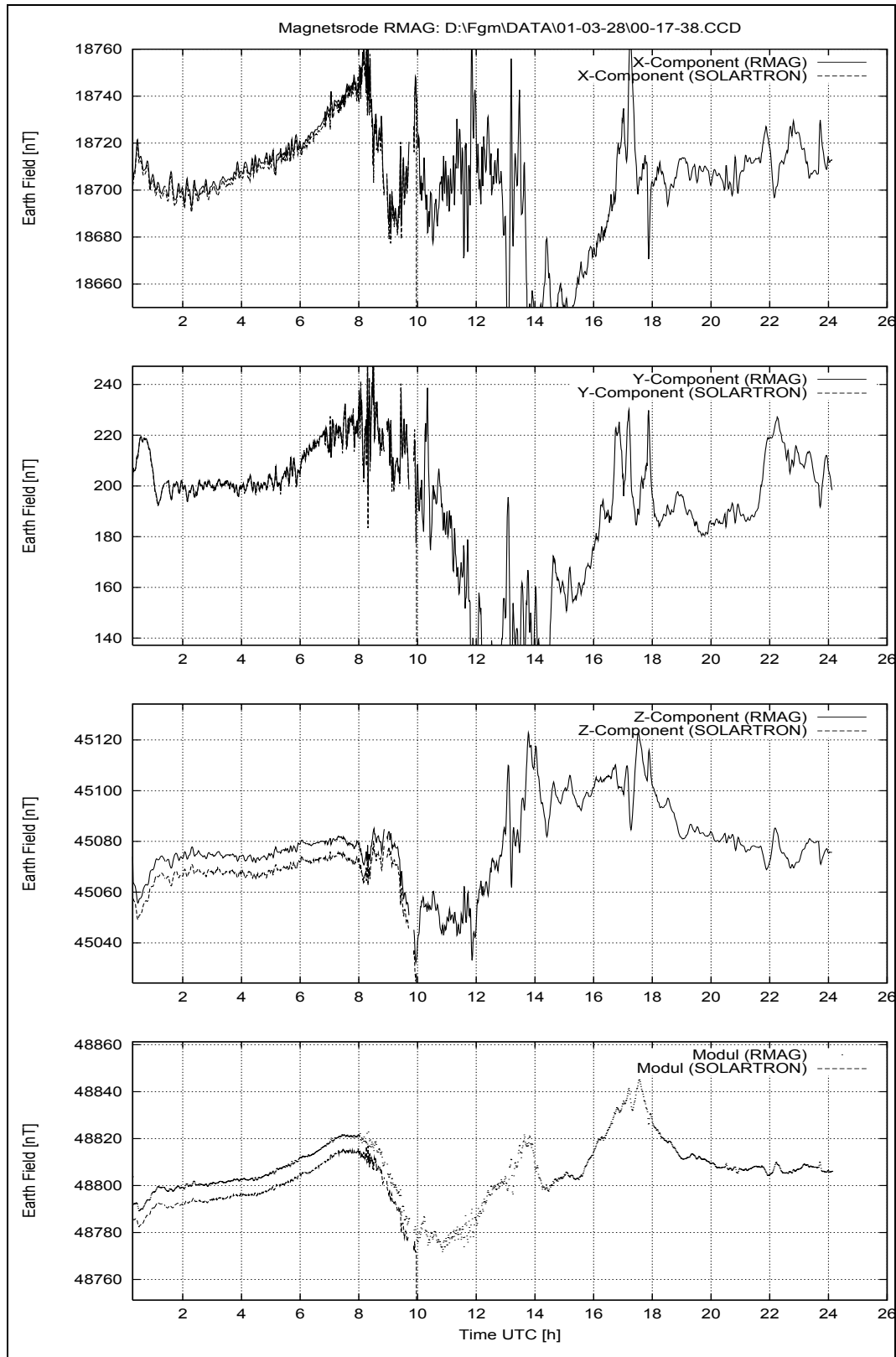

Figure 40: March 28, 2001: Earthfield variations.

R O S E T T A		Document: RO-IGM-TR-0002
		Issue: 2
		Revision: 2
IGM	Institut für Geophysik und Meteorologie Technische Universität Braunschweig	Date: October 10, 2001
		Page: 62

12 Thursday March 29, 2001

12.1 Earth Field Variation Check. DPU: FM, Sensors: FM-IB & FM-OB, Continued

The measurements with a suppressed constant earth field continued over night until the afternoon.

12.1.1 Data

Configuration File	CCD File	CCD File	Remarks
VAR.CFG	01-03-29\00_08_26.CCD		
VAR.CFG	01-03-29\01_09_06.CCD		
VAR.CFG	01-03-29\02_09_48.CCD		
VAR.CFG	01-03-29\03_10_29.CCD		
VAR.CFG	01-03-29\04_11_11.CCD		
VAR.CFG	01-03-29\05_11_52.CCD		
VAR.CFG	01-03-29\06_12_33.CCD		
VAR.CFG	01-03-29\07_13_14.CCD		
VAR.CFG	01-03-29\08_13_54.CCD		
VAR.CFG	01-03-29\09_14_35.CCD		
VAR.CFG	01-03-29\10_15_16.CCD		
VAR.CFG	01-03-29\11_15_56.CCD		
VAR.CFG	01-03-29\12_16_37.CCD		
VAR.CFG	01-03-29\13_17_17.CCD		
VAR.CFG	01-03-29\14_17_58.CCD		

Afterwards the complete ROSETTA system (DPU & Sensors, Power supply & cables, PIU-SIM) has been removed from the facility and shipped to Pfeil in Hildesheim for coating etc. Due to this circumstance the calibration was interrupted until April, 5th.

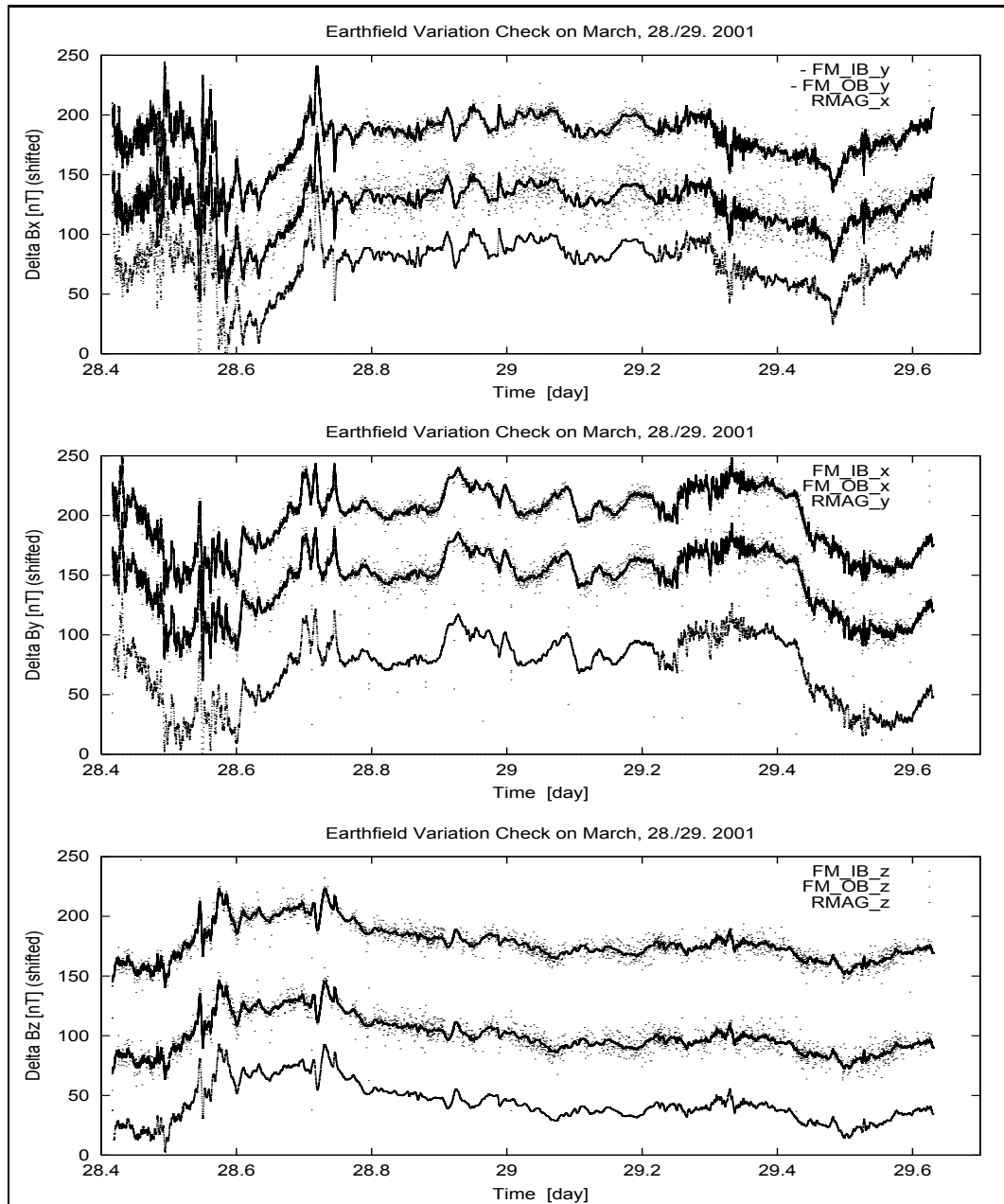

Figure 41: March, 28./29. 2001: Earth field variation Check

12.2 Overview Plots: System Performance, Temperatures and Earth-field Variations.

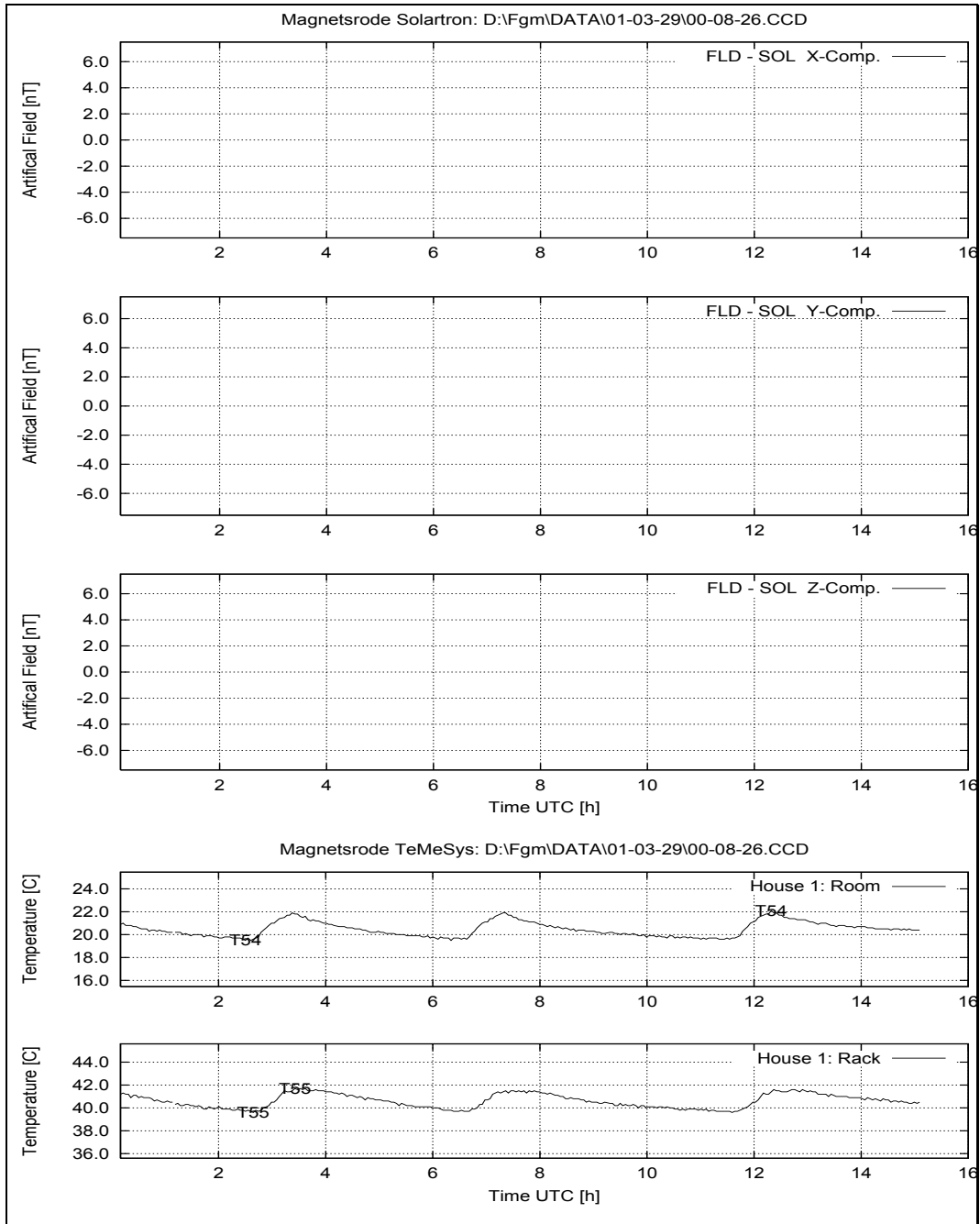

Figure 42: March 29, 2001: System Performance: FLD – SOL; Temperatures at House 1.

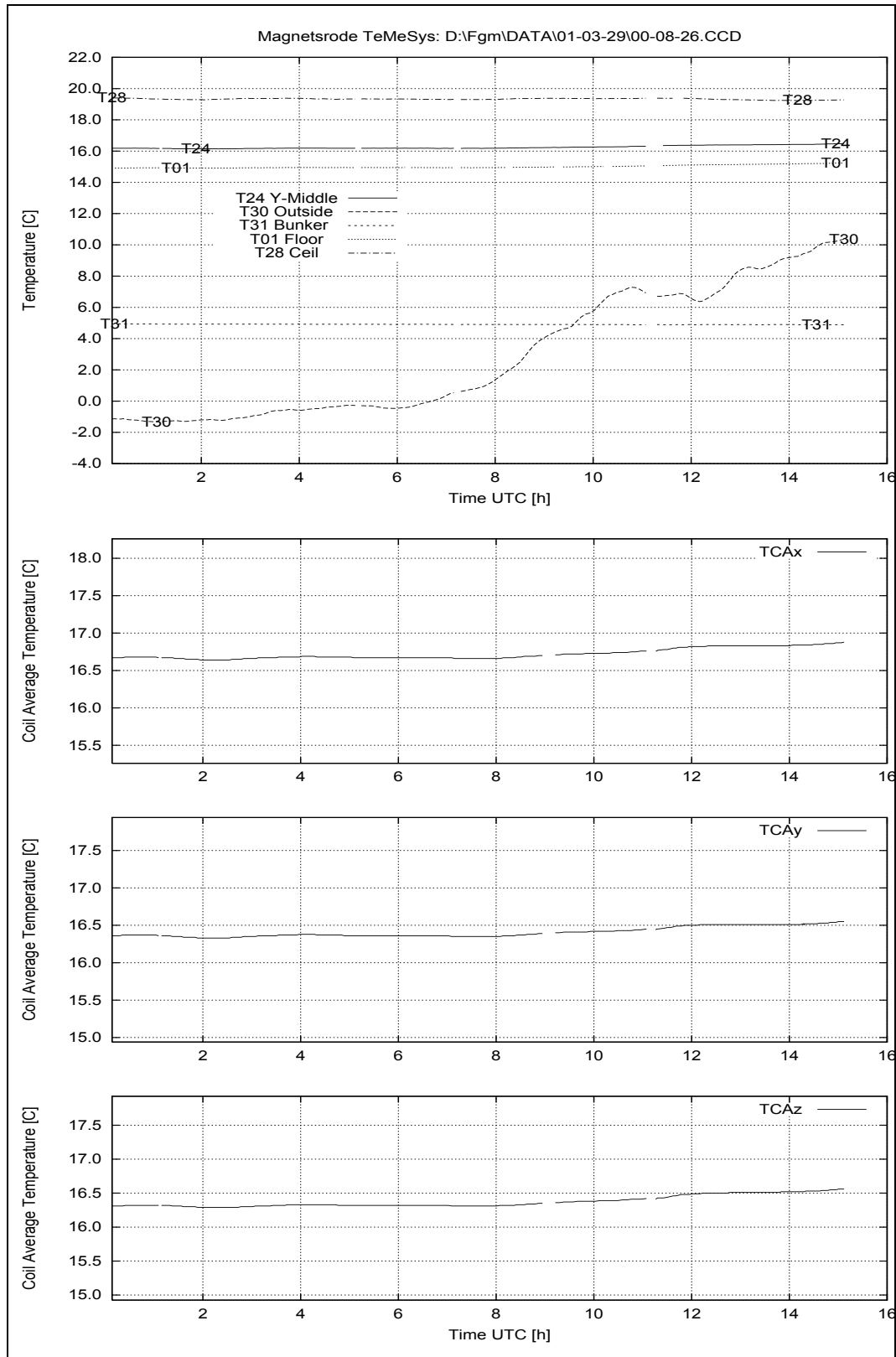

Figure 43: March 29, 2001: Temperatures House 2.

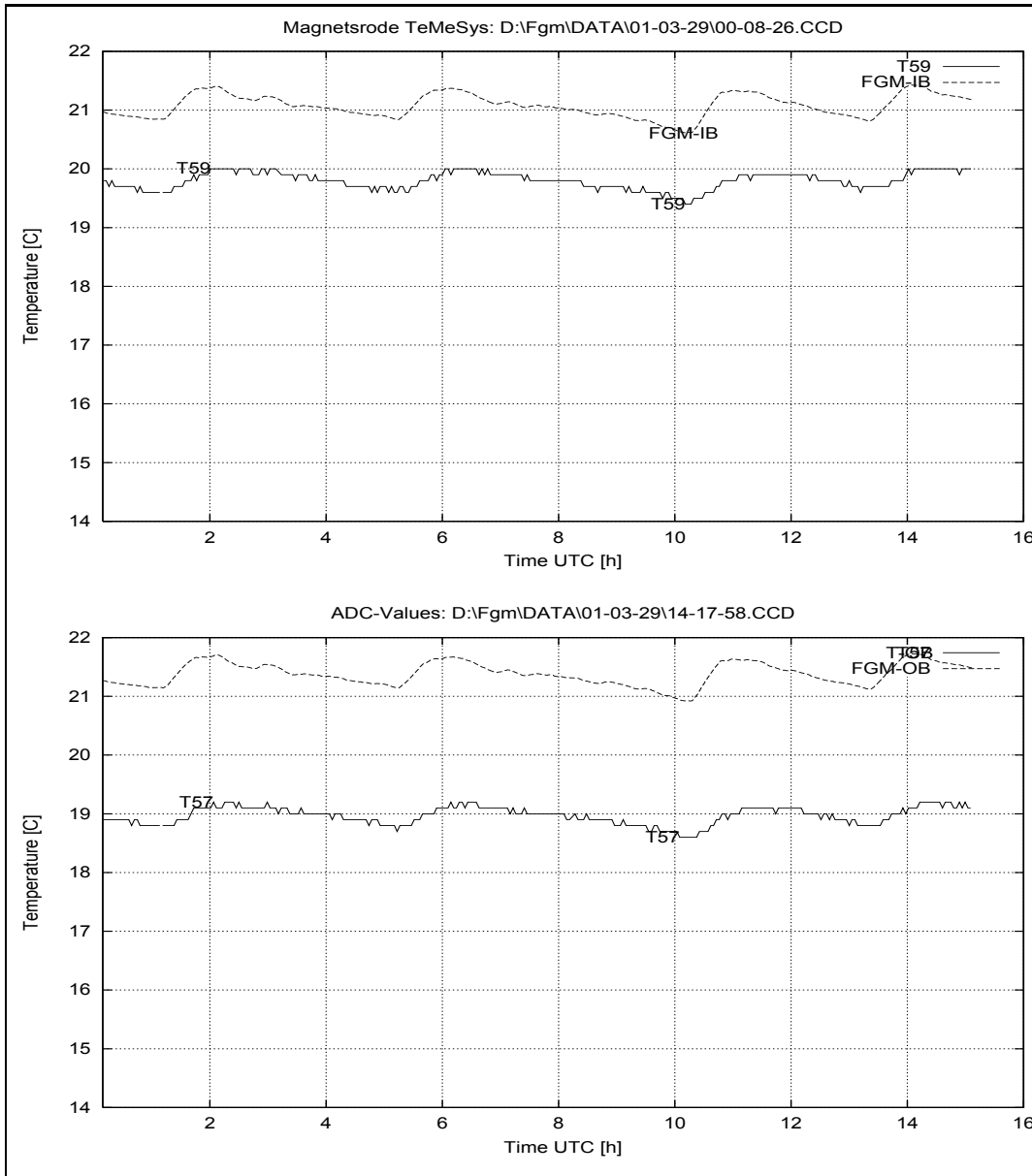

Figure 44: March 29, 2001: Sensor Temperatures at House 2.

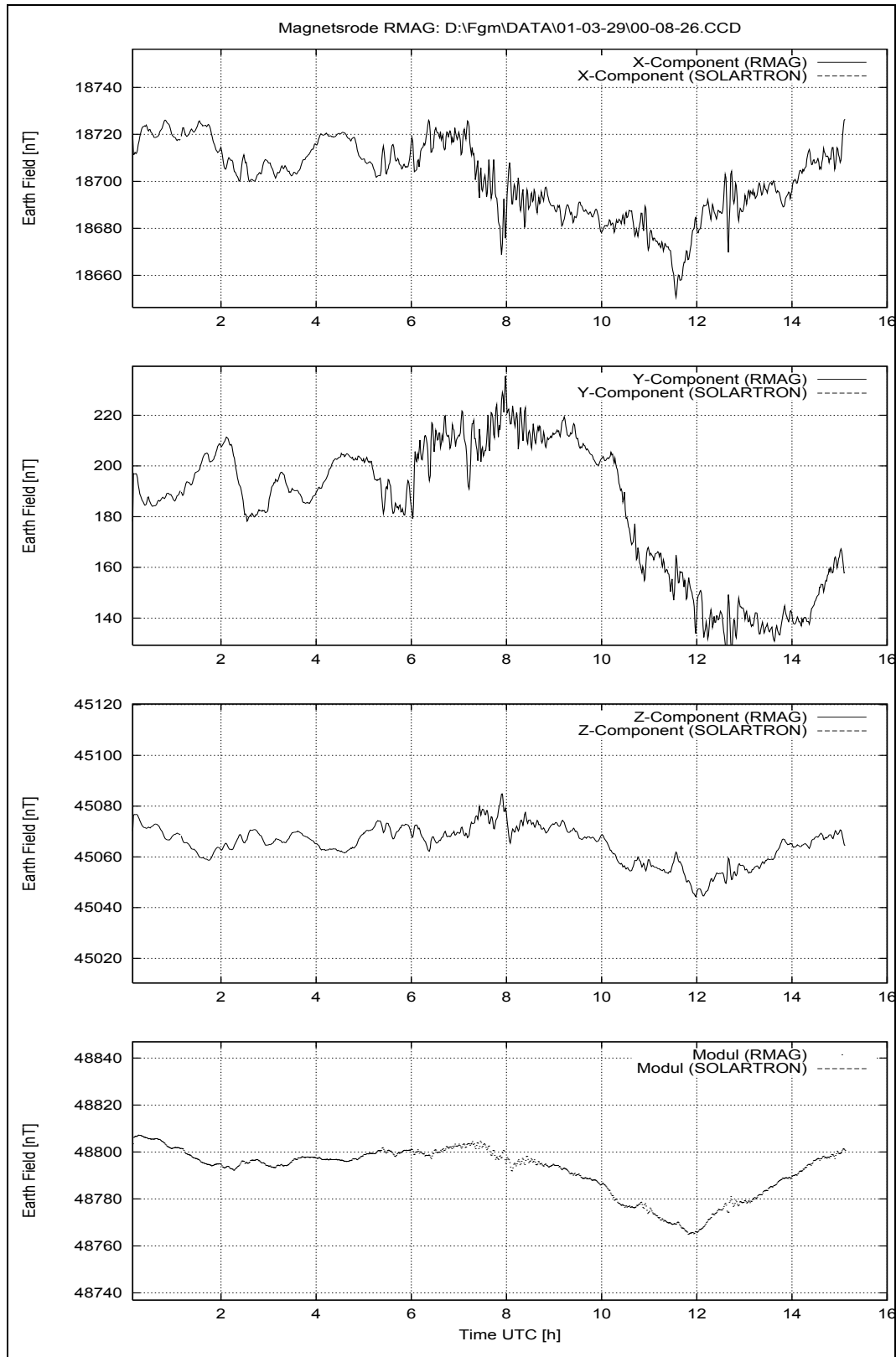

Figure 45: March 29, 2001: Earthfield variations.

R O S E T T A		Document: RO-IGM-TR-0002
		Issue: 2
		Revision: 2
IGM	Institut für Geophysik und Meteorologie Technische Universität Braunschweig	Date: October 10, 2001
		Page: 68

13 Thursday April 5, 2001

Until now the **FM DPU** connected to the **FM Sensors** has been checked. For the following measurements we switch over to the **FS DPU**, however, connected to the **FM sensors**.

We start with the Offset measurements.

13.1 Offset Measurements — DPU: FS, Sensors FM-IB & FM-OB

To perform the offset measurements both sensors are mounted with their aluminium support at the stand on top of the green trolley. Figure 236 shows a photographic view of the setup in the normal position for the measurement of FM-OB. The following figures show the turned positions according to the test procedure.

Purpose: Measure the FM-IB & and FM-OB offset.
MAD: Ch0 to Ch2 connected to ZopfMag x to z, 10 nT/mV;
Ch7 FSP pulse;
Timer 500, SumUp 100, Vector rate 1.00 Hz.

PREMA:
Files: OFF?_?1.SEQ
Start: 05.04.01 09:34
End: 05.04.01 10:35

13.1.1 Data

Configuration File	CCD File	Position Picture
		Position 1: Normal
ali10.CFG	01-04-05\09_34_37.CCD	OB @ CoC, height: 13cm, 010405A
offx_N1.CFG	01-04-05\09_42_17.CCD	
Configuration File	CCD File	Position Picture
		Position 2: Normal
offx_N1.CFG	01-04-05\09_46_47.CCD	IB @ CoC, height: 13cm, 010405B
Configuration File	CCD File	Position Picture
		Position 3: Turned @ \Zc
ALI10.CFG	01-04-05\09_51_50.CCD	OB @ CoC, height: 13cm, 010405C
offx_t1.CFG	01-04-05\09_59_00.CCD	

R O S E T T A		Document: RO-IGM-TR-0002
		Issue: 2
		Revision: 2
IGM	Institut für Geophysik und Meteorologie Technische Universität Braunschweig	Date: October 10, 2001
		Page: 69

Configuration File	CCD File	Position Picture
offx_t1.CFG	01-04-05\10_06_02.CCD	Position 4: Turned @ \Zc IB @ CoC, height: 13cm, 010405D

Configuration File	CCD File	Position Picture
ali10.CFG	01-04-05\10_15_05.CCD	Position 5: Turned @ \Yc OB @ CoC, height: 20cm, 010405E
offz_t1.CFG	01-04-05\10_22_15.CCD	

Configuration File	CCD File	Position Picture
offz_t1.CFG	01-04-05\10_29_10.CCD	Position 6: Turned @ \Yc IB @ CoC, height: 20cm, 010405F

After these measurements the setup was changed for the frequency measurements.

13.2 Digital Frequency Response — DPU: FS, Sensors FM-IB & FM-OB

The digital frequency response function will be measured with two different amplitudes. For these chosen amplitudes the frequency will be discretely swept from 1000 Hz down to 100 mHz. The sensors were placed diagonal in space on the open Thermal Test Box mounting plate (refer to picture 242). The aluminium sensor support is elevated by 45° from the X_C - Y_C plane using the gray diagonal stand which is turned around Z_C by 54° . This is to get equal signals on all sensor components from the fields applied on the Y_C component. The measurements are performed for both sensors in parallel.

Purpose: Measure the digital frequency response
Conditions: FM-IB & FM-OB placed diagonal in space in the coil system center.
FM-OB is the upper, FM-IB the lower one
AC-Generator signal (AC2) applied to Y_C without attenuator.
MAD: Ch0 to Ch2 connected to Zopfmag x to z, 10 nT/mV;
Ch6 Generator signal (AC2) direct (no attenuation);
Ch7 FSP pulse;
Timer 500, SumUp 6, Vector Rate 16.67 Hz.
Files: F.SEQ
Start: 05.04.01 10:45
End: 05.04.01 12:46

R O S E T T A		Document: RO-IGM-TR-0002
		Issue: 2
		Revision: 2
IGM Institut für Geophysik und Meteorologie Technische Universität Braunschweig		Date: October 10, 2001
		Page: 70

13.2.1 Data

Configuration File	CCD File
ali10.CFG	01-04-05\10_45_49.CCD
fd_H.CFG	01-04-05\10_53_16.CCD
fd_L.CFG	01-04-05\11_40_37.CCD

After the data collection the setup was changed for the linearity measurements of the FM-OB sensor.

13.3 Linearity, Sensitivity and Cross Talk — DPU: FS, Sensors: FM-OB

The calibration mirror #OB was placed on the FM-OB sensor. After the optical alignment of the FM-OB sensor (refer to table 1 column #3) the linearity, sensitivity and cross talk measurements were initialised.

Purpose: Measure the linearity, sensitivity and cross talk data set
Conditions: FM-OB in optical aligned position at CoC
FM-IB south of CoC on aluminium support.
Refer to picture 243.
MAD: Ch0 to Ch2 connected to ZopfMag x to z, 10 nT/mV;
Ch7 FSP pulse;
Timer 500, SumUp 100, Vectorrate 1.00 Hz.
Files: M010405.SEQ
Start: 05.04.01 12:59
End: 06.04.01 05:14

13.3.1 Data

Configuration File	CCD File
ALI10.cfg	01-04-05\12_59_59.CCD
LX15.CFG	01-04-05\13_08_09.CCD
LY15.CFG	01-04-05\13_39_12.CCD
LZ15.CFG	01-04-05\14_10_13.CCD
SP15spir.CFG	01-04-05\14_41_13.CCD
SP15sphe.CFG	01-04-05\18_33_57.CCD
LX15.CFG	01-04-05\23_06_37.CCD
LY15.CFG	01-04-05\23_37_38.CCD

13.4 Overview Plots: System Performance, Temperatures and Earth-field Variations.

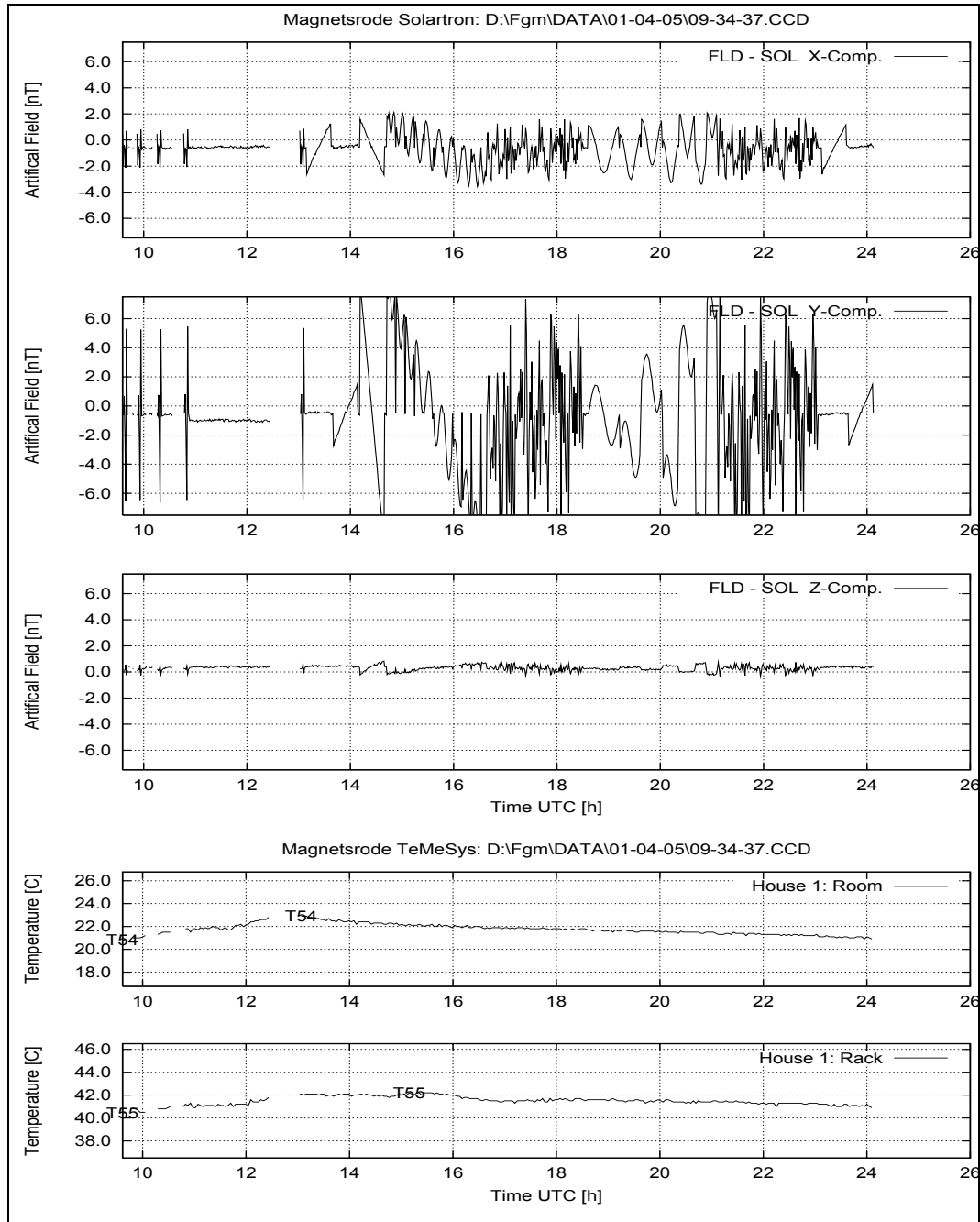

Figure 46: April 5, 2001: System Performance: FLD – SOL; Temperatures at House 1.

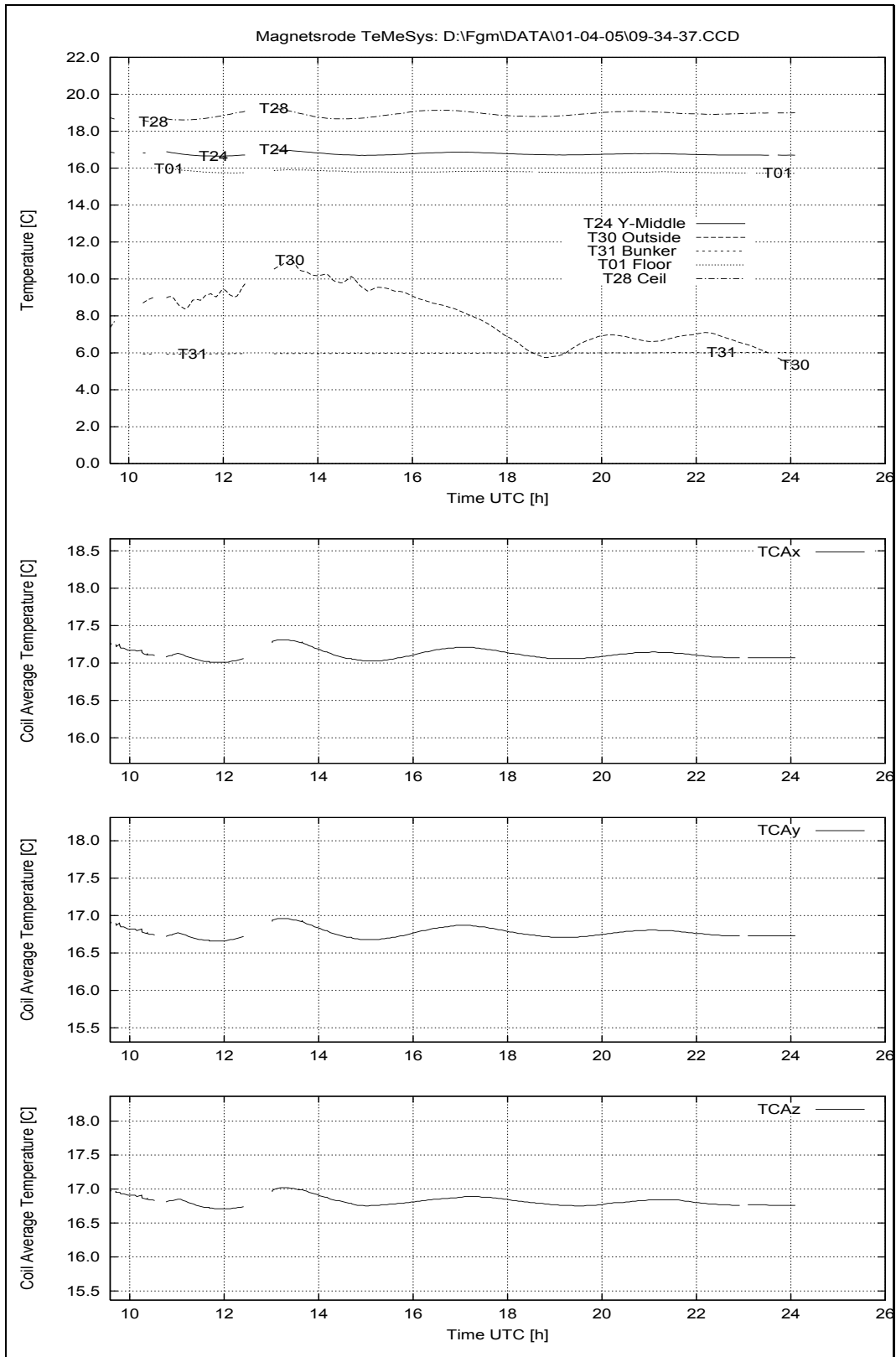

Figure 47: April 5, 2001: Temperatures House 2.

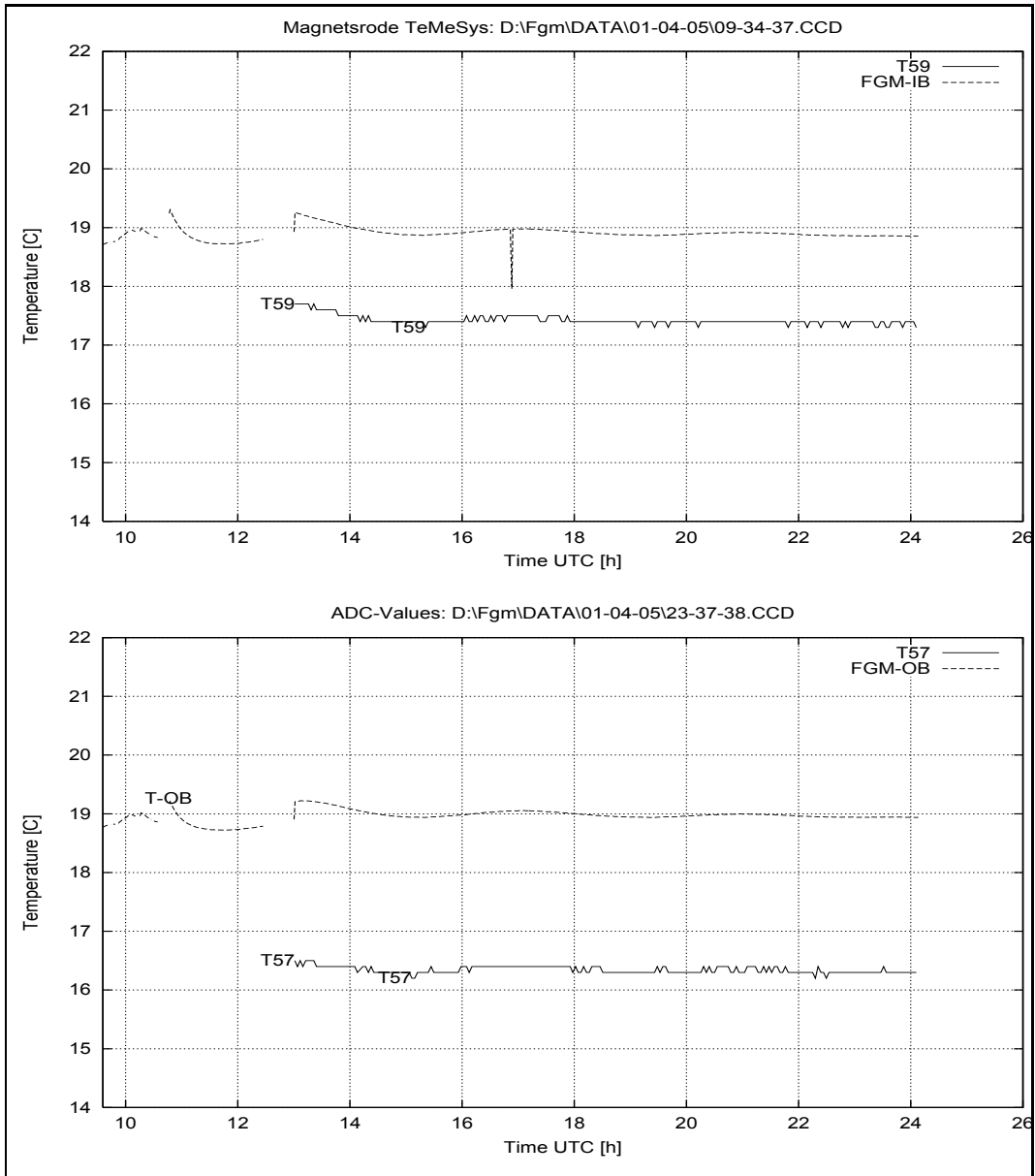

Figure 48: April 5, 2001: Sensor Temperatures at House 2.

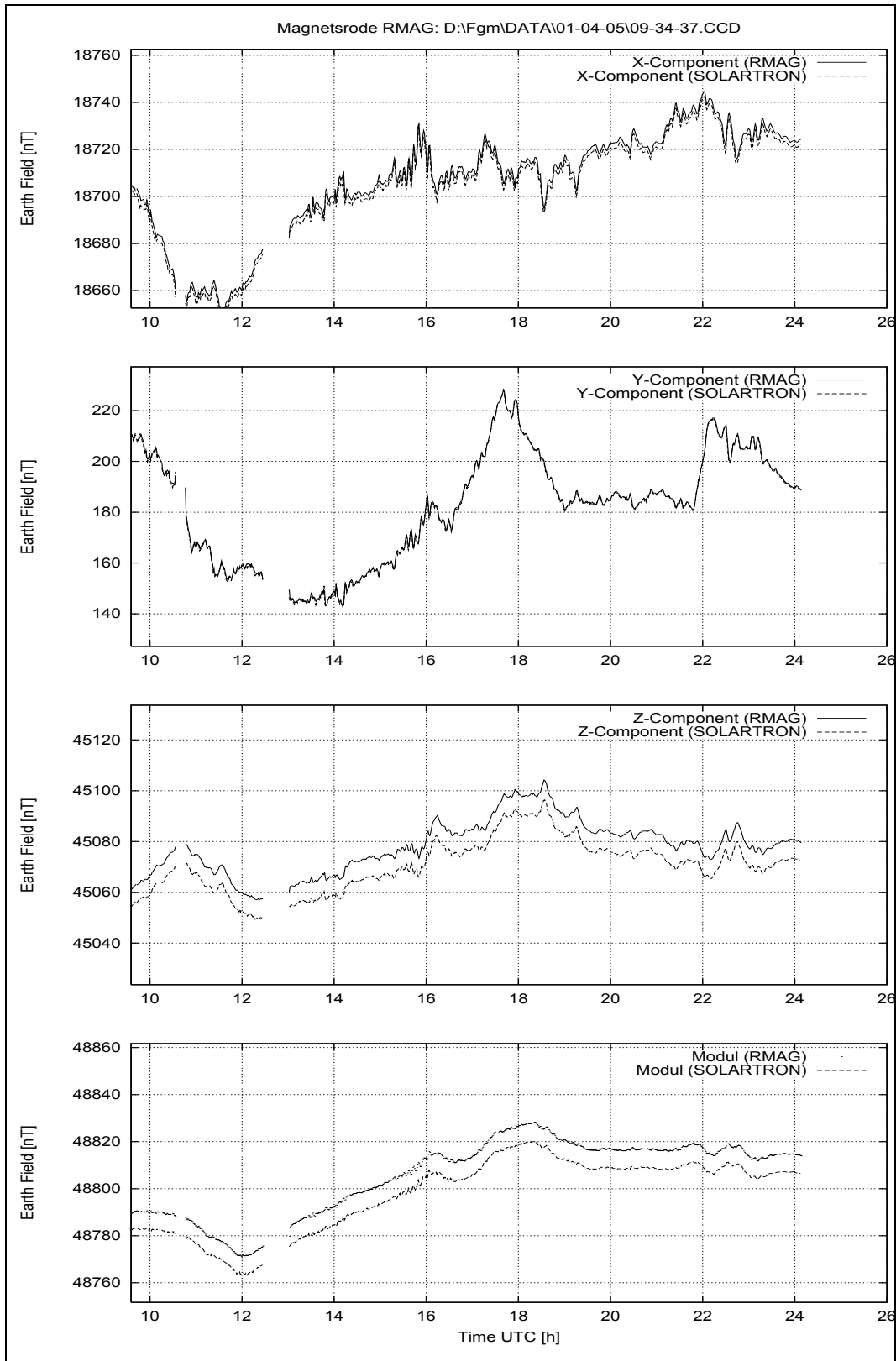

Figure 49: April 5, 2001: Earthfield variations.

R O S E T T A		Document: RO-IGM-TR-0002
		Issue: 2
		Revision: 2
IGM	Institut für Geophysik und Meteorologie Technische Universität Braunschweig	Date: October 10, 2001
		Page: 75

14 Friday April 6, 2001

14.1 Linearity, Sensitivity and Cross Talk — DPU: FS, Sensors: FM-OB, Continued

The linearity, sensitivity and cross talk measurements did go on until the early morning. The investigations were finished at 05:14.

14.1.1 Data

Configuration File	CCD File
LZ15.CFG	01-04-06\00_08_38.CCD
SP15s _s phe.CFG	01-04-06\00_39_39.CCD

After the data collection the setup was changed for the linearity measurements of the FM-IB sensor.

14.2 Linearity, Sensitivity and Cross Talk — DPU: FS, Sensors: FM-IB

The calibration mirror # IB was placed on the FM-IB sensor. After the optical alignment of the FM-IB sensor (refer to table 1 column #4) the linearity, sensitivity and cross talk measurements were initialised.

Purpose: Measure the linearity, sensitivity and cross talk data set
Conditions: FM-IB in optical aligned position at CoC
FM-OB north of CoC on aluminium support.
Refer to picture 244.
MAD: Ch0 to Ch2 connected to ZopfMag x to z, 10 nT/mV;
Ch7 FSP pulse;
Timer 500, SumUp 100, Vectorrate 1.00 Hz.
Files: M010406.SEQ
Start: 06.04.01 07:18
End: 06.04.01 12:53

R O S E T T A		Document: RO-IGM-TR-0002
		Issue: 2
		Revision: 2
IGM	Institut für Geophysik und Meteorologie Technische Universität Braunschweig	Date: October 10, 2001
		Page: 76

14.2.1 Data

Configuration File	CCD File
ALI10.cfg	01-04-06\07_18_23.CCD
LX15.CFG	01-04-06\07_25_45.CCD
LY15.CFG	01-04-06\07_56_49.CCD
LZ15.CFG	01-04-06\08_27_52.CCD
SP15spir.CFG	01-04-06\08_58_51.CCD

After these measurements the units were shipped temporarily to IC / London.

14.3 Overview Plots: System Performance, Temperatures and Earth-field Variations.

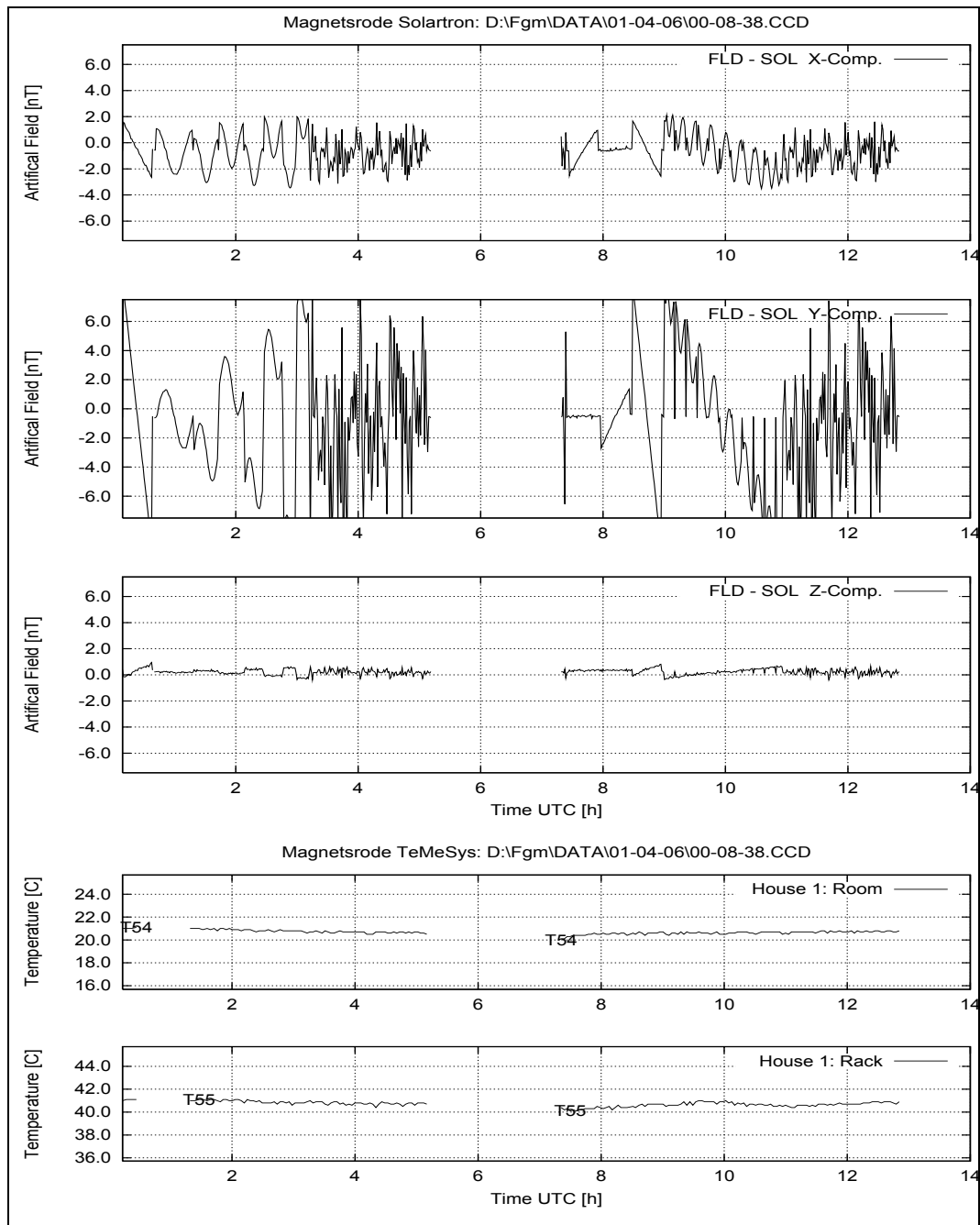

Figure 50: April 6, 2001: System Performance: FLD – SOL; Temperatures at House 1.

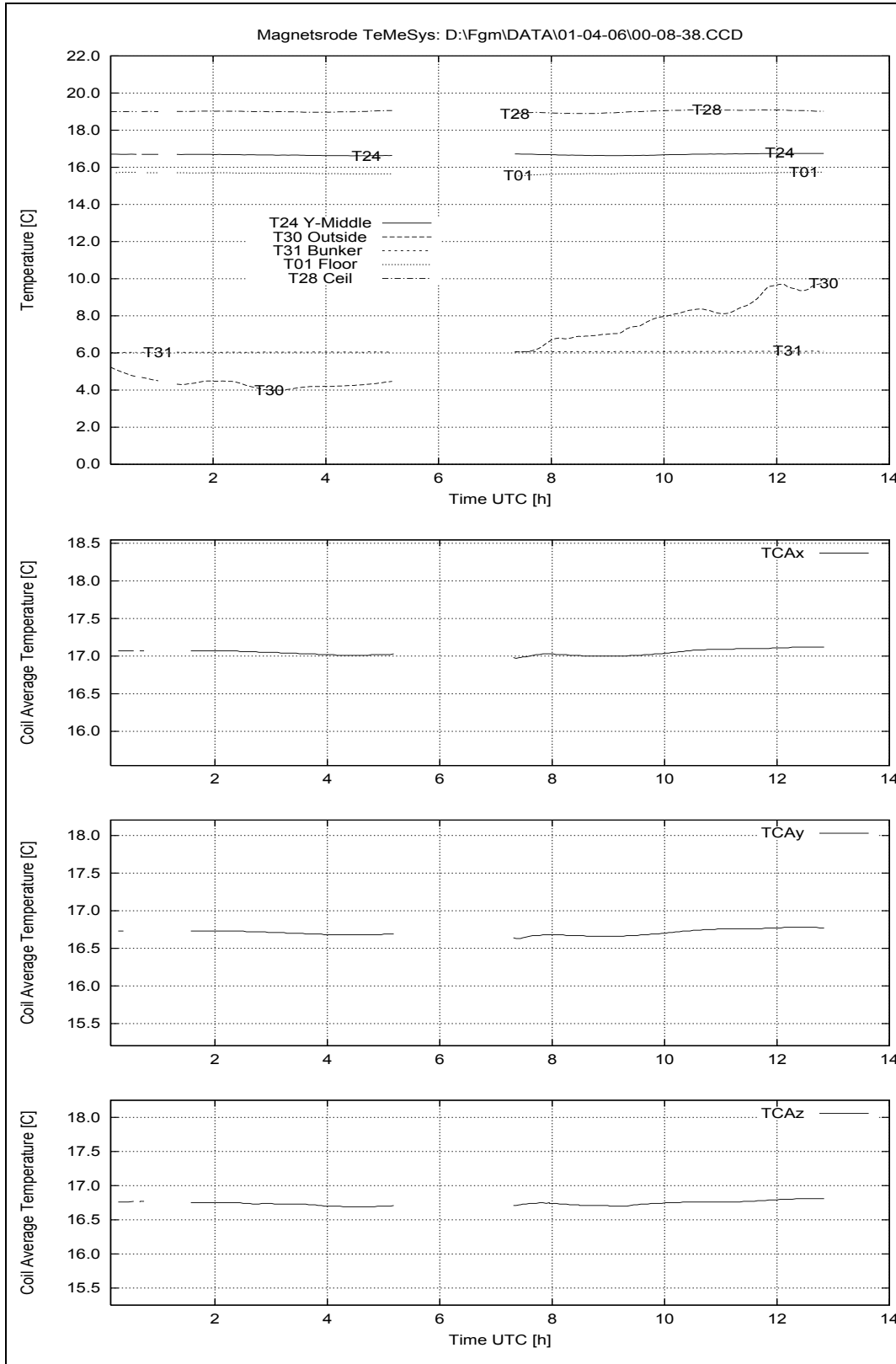

Figure 51: April 6, 2001: Temperatures House 2.

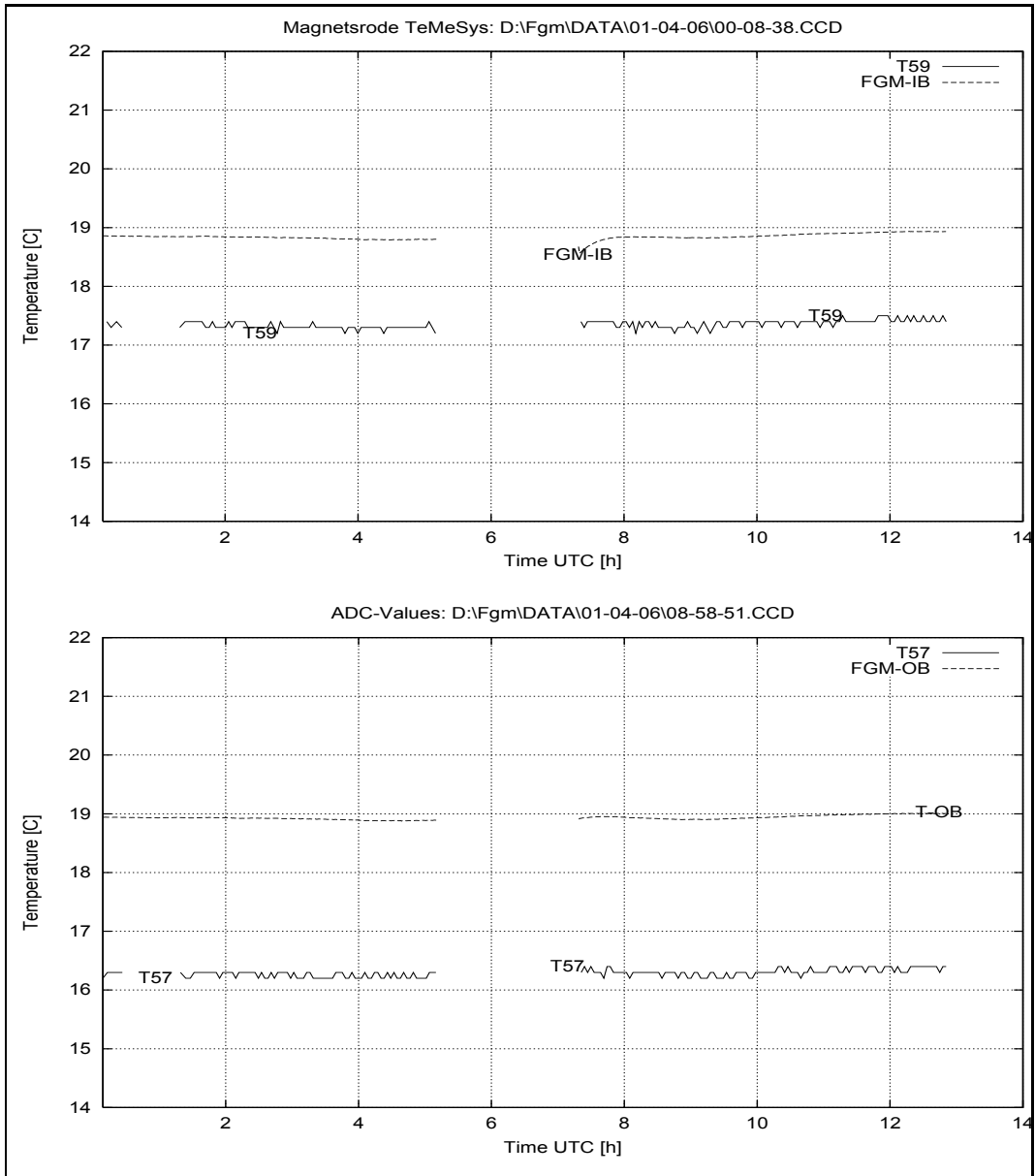

Figure 52: April 6, 2001: Sensor Temperatures at House 2.

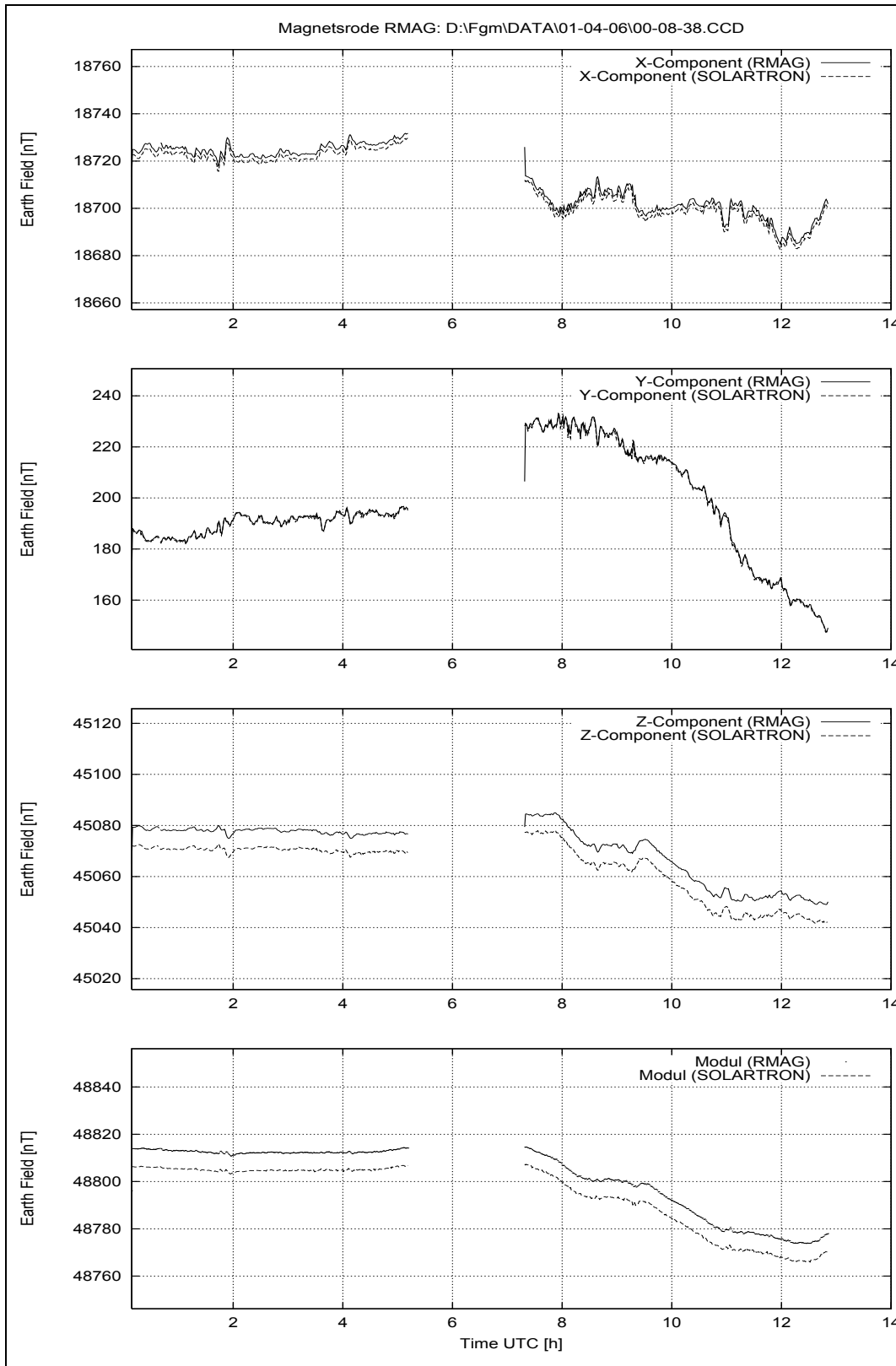

Figure 53: April 6, 2001: Earthfield variations.

R O S E T T A		Document: RO-IGM-TR-0002
		Issue: 2
		Revision: 2
IGM	Institut für Geophysik und Meteorologie	Date: October 10, 2001
	Technische Universität Braunschweig	Page: 81

15 Friday April 20, 2001

The recently performed measurements dealt with the **FS DPU** in connection with the **FM Sensors**. As there are still some measurements missing for the combination **FM DPU / FM Sensors** we now switch again back to the latter DUT to perform frequency measurements and the power variation check.

15.1 Digital Frequency Response — DPU: FM, Sensors FM-IB & FM-OB

The digital frequency response function will be measured with two different amplitudes. For these chosen amplitudes the frequency will be discretely swept from 1000 Hz down to 100 mHz. The sensors were placed diagonal in space on the open Thermal Test Box mounting plate (refer to picture 245). As the aluminium support is N/A (shipped to Pfeil) today, the sensors were placed and fixed on the small green mounting plate of the EMC Gradiometer System. Mounting scheme as follows:

1. Sensor (top) Gradiometer Sensor 1
2. Sensor FM-OB
3. Sensor Gradiometer Sensor 2
4. Sensor (bottom) FM-IB

The temperature sensors T₅₆, T₅₈, T₅₉, and T₆₀ are placed on the green thermobox mounting plate below the MAG sensors.

The aluminium sensor support is elevated by 45° from the X_c-Y_c plane using the gray diagonal stand which is turned around Z_c by 54°. This is to get equal signals on all sensor components from the fields applied on the Y_c component. The measurements are performed for both sensors in parallel.

Purpose: Measure the digital frequency response
Conditions: FM-IB & FM-OB placed diagonal in space in the coil system center.
 FM-OB is the upper, FM-IB the lower one
 AC-Generator signal (AC2) applied to Y_c without attenuator.
MAD: Ch0 to Ch2 connected to Zopfmag x to z, 10 nT/mV;
 Ch6 Generator signal (AC2) direct (no attenuation);
 Ch7 FSP pulse;
 Timer 500, SumUp 6, Vector Rate 16.67 Hz.
Files: F.SEQ
Start: 20.04.01 08:53
End: 20.04.01 10:35

15.1.1 Data

Configuration File	CCD File
ALI10.cfg	01-04-20\08_53_39.CCD
fd_h.CFG	01-04-20\09_01_12.CCD
fd_l.CFG	01-04-20\09_48_34.CCD

Afterwards the setup for the voltage variation check was prepared.

15.2 Supply Voltage Dependence — DPU: FM, Sensors FM-IB & FM-OB

With this check it should be tested whether the digital readings are influenced by the supply voltage. Therefore, the supply voltages generated by the instrument power supply are varied in discrete steps. The needed positive and negative supply voltages are changed in parallel at the same time.

The used voltages are:

Step	Voltage [V]	%-Variation
1	±5.00	abs(Nominal)
2	±4.90	abs(Nominal) -2%
3	±4.75	abs(Nominal) -5%
4	±4.50	abs(Nominal) -10%
5	±5.10	abs(Nominal) +2%
6	±5.25	abs(Nominal) +5%
7	±5.50	abs(Nominal) +10%

The test is done for both, FM-OB and FM-IB, sensors. The sensors are placed in diagonal in space position. Unchanged since the recent frequency measurements. Refer to picture 245.

Purpose: Measure supply voltage dependence of the digital data readings.
 Conditions: FM-IB & FM-OB placed diagonal in space in the coil system center.
 FM-OB is the upper, FM-IB the lower one
 MAD: Ch0 to Ch2 connected to Zopfmag x to z, 10 nT/mV;
 Ch7 FSP pulse;
 Timer 500, SumUp 6, Vector Rate 16.67 Hz.
 Files: PWR_VAR.*
 Start: 20.04.01 10:49:54
 End: 20.04.01 11:27

R O S E T T A		Document: RO-IGM-TR-0002
IGM Institut für Geophysik und Meteorologie Technische Universität Braunschweig		Issue: 2
		Revision: 2
		Date: October 10, 2001
		Page: 83

15.2.1 Data

Configuration File	CCD File ADC1
PWR_VAR.cfg	01-04-20\10_49_54.CCD
PWR_VAR.cfg	01-04-20\10_58_12.CCD
PWR_VAR.cfg	01-04-20\11_03_07.CCD
PWR_VAR.cfg	01-04-20\11_07_39.CCD
PWR_VAR.cfg	01-04-20\11_12_51.CCD
PWR_VAR.cfg	01-04-20\11_17_23.CCD
PWR_VAR.cfg	01-04-20\11_22_01.CCD

15.2.2 Results

The following plots show the results of the supply voltage variation check. As visible in the first diagram of figure 54 and 55 the applied field structure was 0 nT, +20000 nT, -20000 nT, 0 nT for every pair of supply voltages. For a better visibility the y -component has been plotted with an inverted sign. Additionally the single traces have been shifted by convenient offsets for a maximum of clarity.

The analysis of the plots reveals that the y - and the z -component are nearly constant, the x -component, however, shows significant changes in dependency of the supply voltage. Figure 56 shows the result in the most clear way, as the output signals of both, the FM-OB and the FM-IB sensors, are plotted versus the deviation of the supply voltage.

As the power supply onboard the ROSETTA s/c will keep the voltages constant in the order of 1 %, the performance of the instrument is acceptable.

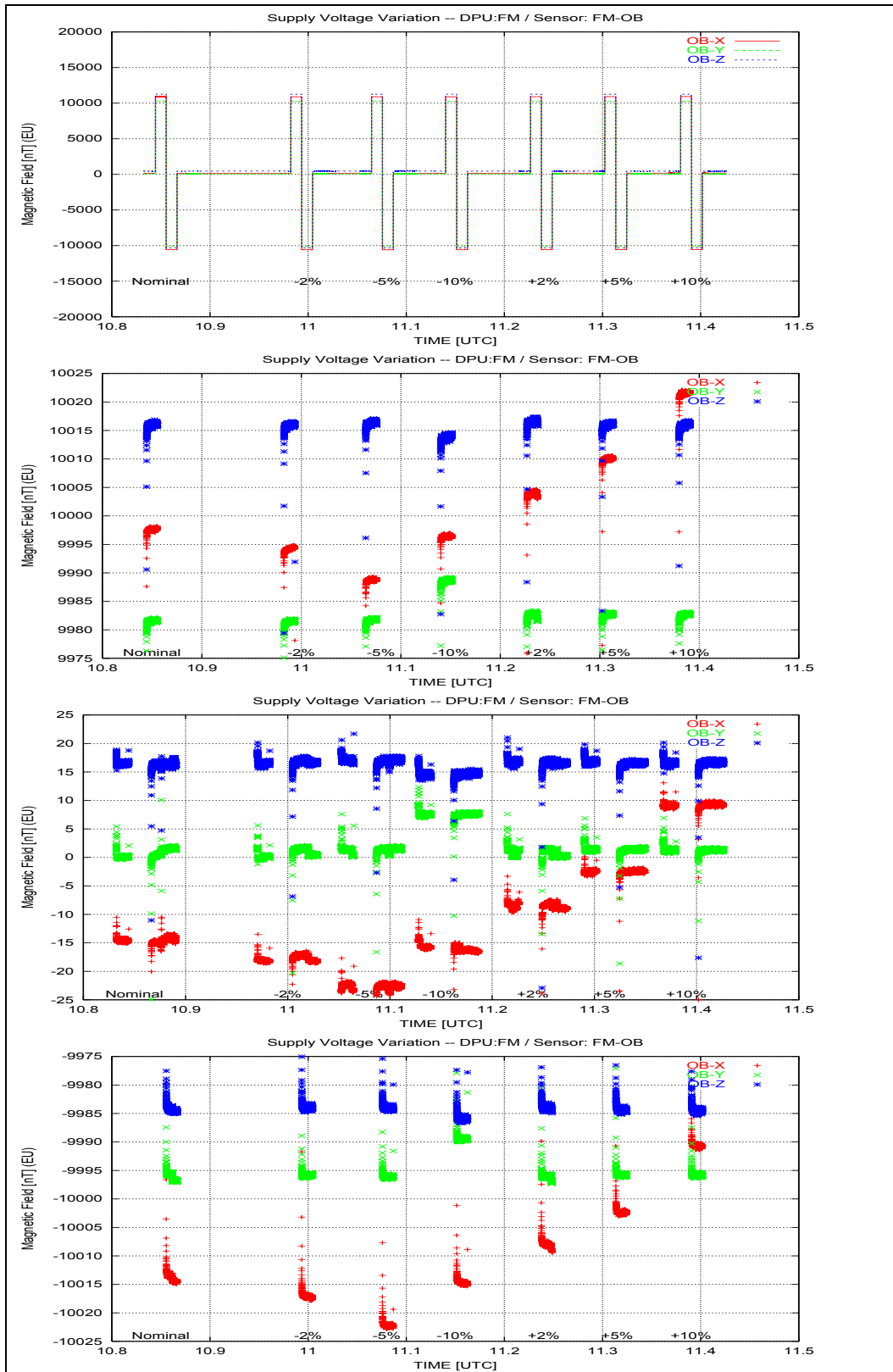

Figure 54: Supply voltage dependence results: FM – OB.

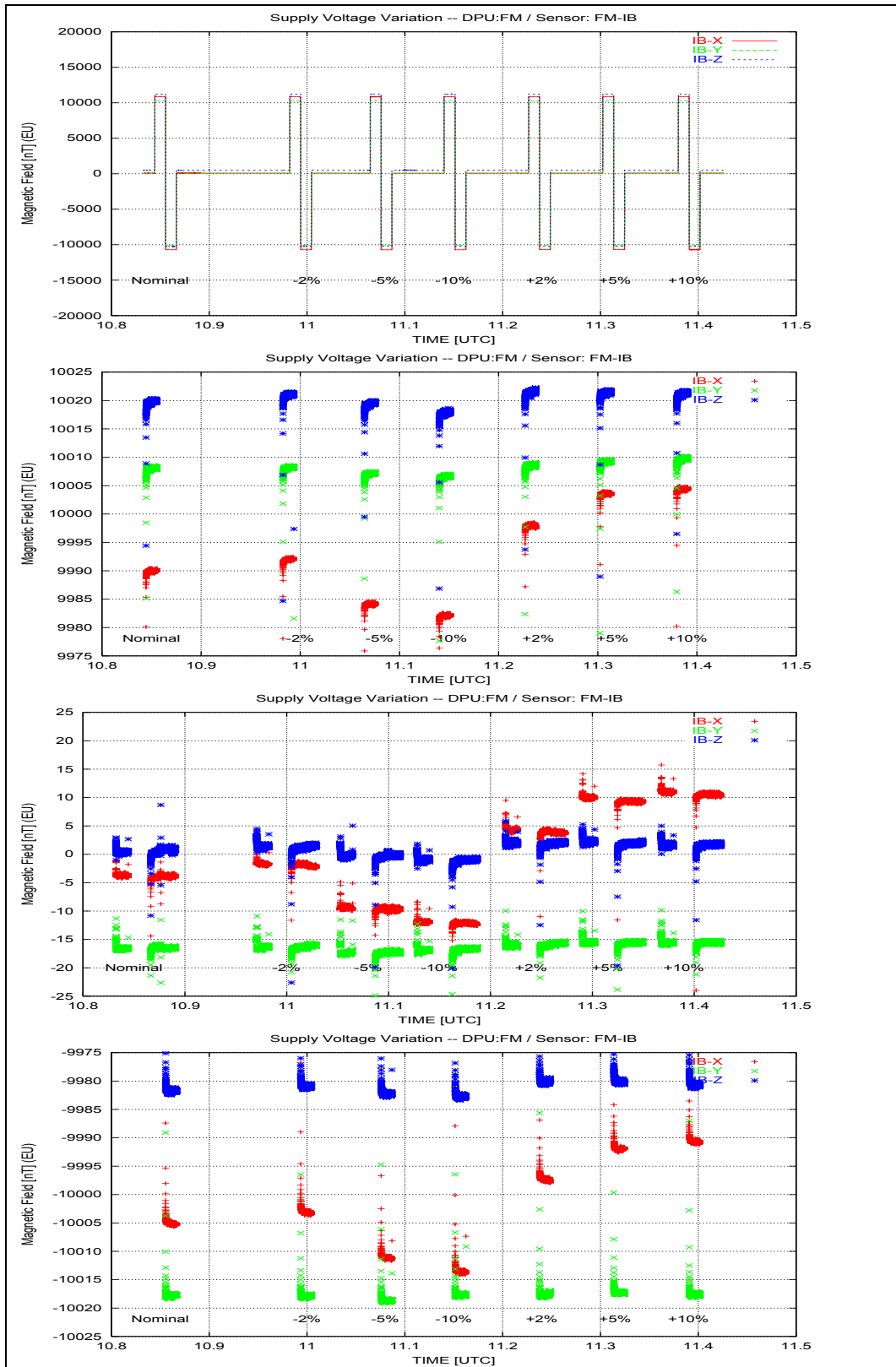

Figure 55: Supply voltage dependence results: FM – IB.

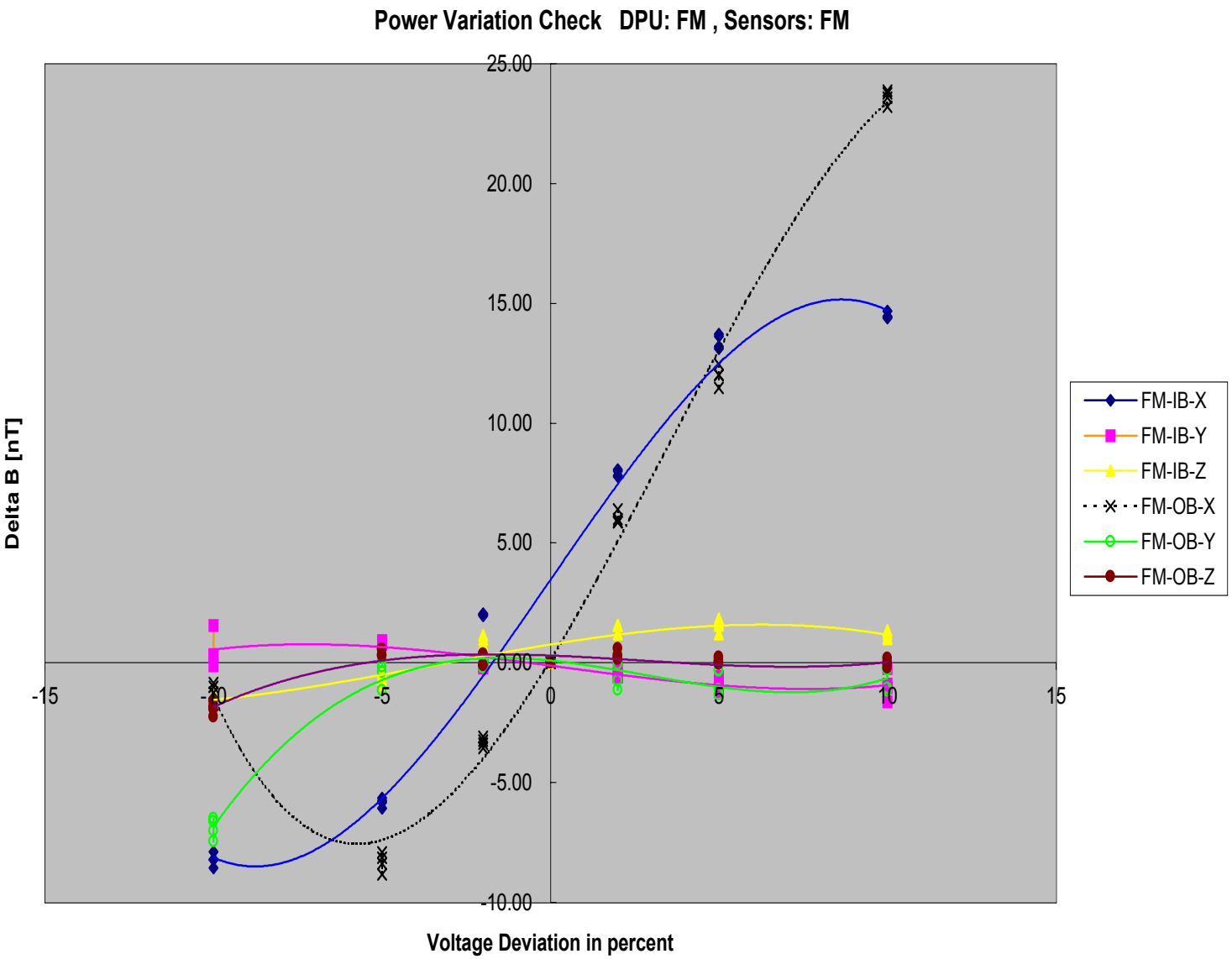

Figure 56: Supply voltage dependence results: DPU: FM, Sensors: FM.

R O S E T T A		Document: RO-IGM-TR-0002
IGM Institut für Geophysik und Meteorologie Technische Universität Braunschweig		Issue: 2
		Revision: 2
		Date: October 10, 2001
		Page: 87

After these measurements the DUT was changed from the FM-DPU and the FM-Sensors to the **FM-DPU connected to the FS-Sensors**.

15.3 Linearity, Sensitivity and Cross Talk — DPU: FM, Sensors: FS-IB

The calibration mirror #IB was placed on the FS-IB sensor.
After the optical alignment of the FS-IB sensor (refer to table 2 column #1) the linearity, sensitivity and cross talk measurements were initialised.

Purpose: Measure the linearity, sensitivity and cross talk data set
Conditions: FS-IB in optical aligned position at CoC
FS-OB north of CoC on aluminium support.
Refer to picture 246.
MAD: Ch0 to Ch2 connected to ZopfMag x to z, 10 nT/mV;
Ch7 FSP pulse;
Timer 500, SumUp 100, Vectorrate 1.00 Hz.
Files: M010420.SEQ
Start: 20.04.01 12:00
End: 21.04.01 10:08

15.3.1 Data

Configuration File	CCD File
ALI10.cfg	01-04-20\12_00_24.CCD
STABTST.cfg	01-04-20\12_07_49.CCD
STABTST.cfg	01-04-20\13_08_30.CCD
LX15.CFG	01-04-20\14_09_12.CCD
LY15.CFG	01-04-20\14_40_13.CCD
LZ15.CFG	01-04-20\15_11_14.CCD
SP15spir.CFG	01-04-20\15_42_14.CCD
SP15sphe.CFG	01-04-20\19_34_58.CCD

15.4 Overview Plots: System Performance, Temperatures and Earth-field Variations.

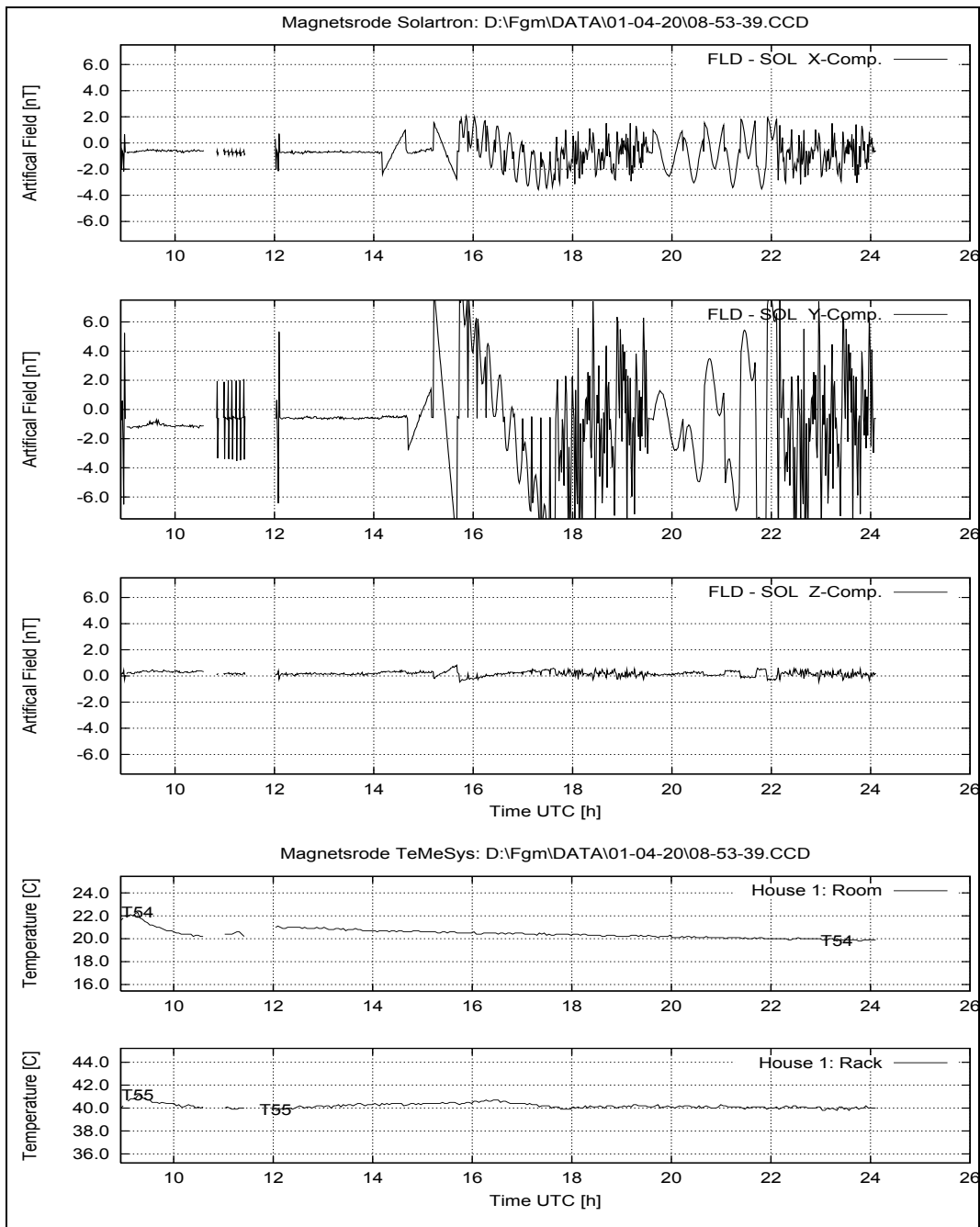

Figure 57: April 20, 2001: System Performance: FLD – SOL; Temperatures at House 1.

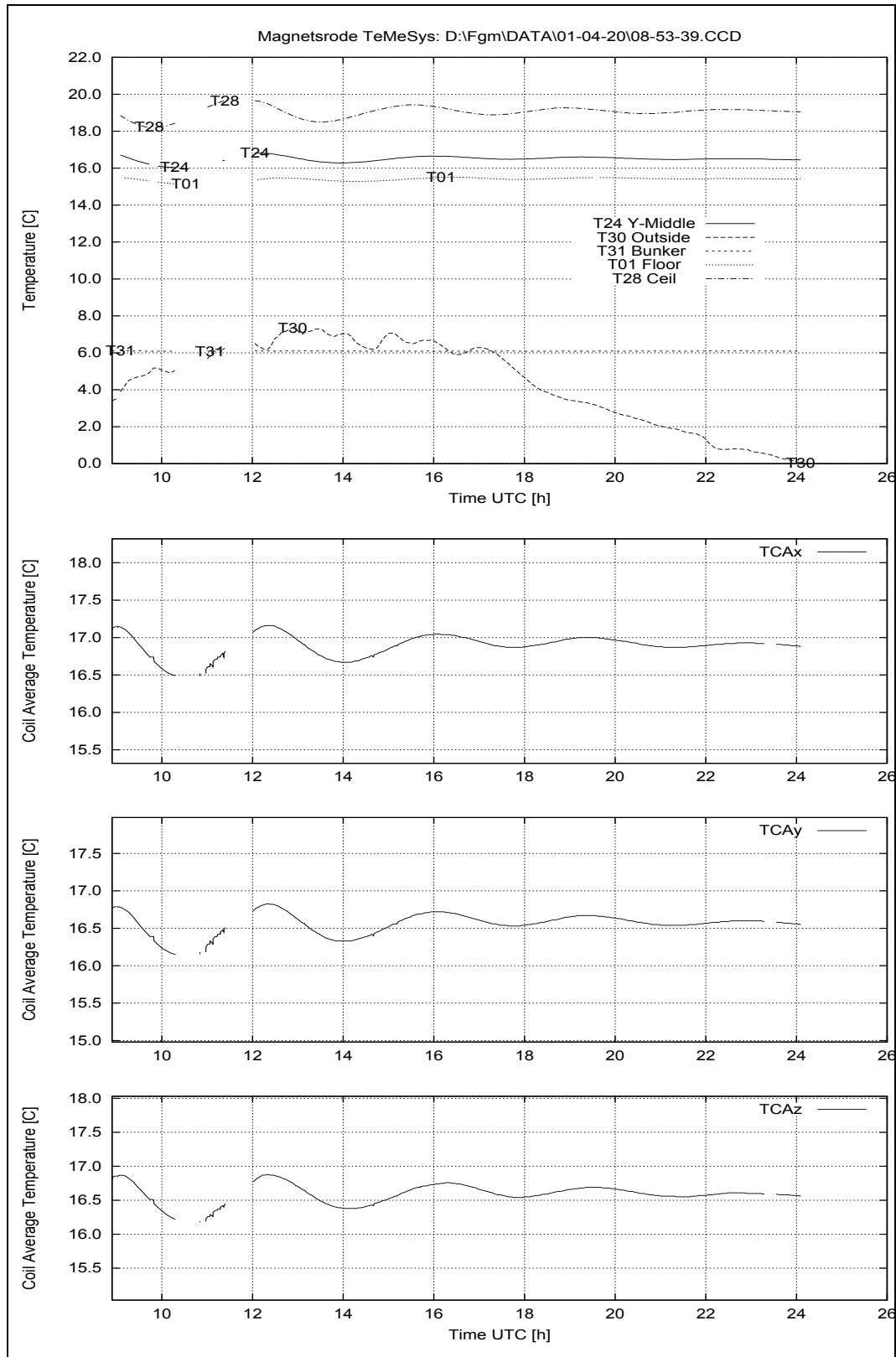

Figure 58: April 20, 2001: Temperatures House 2.

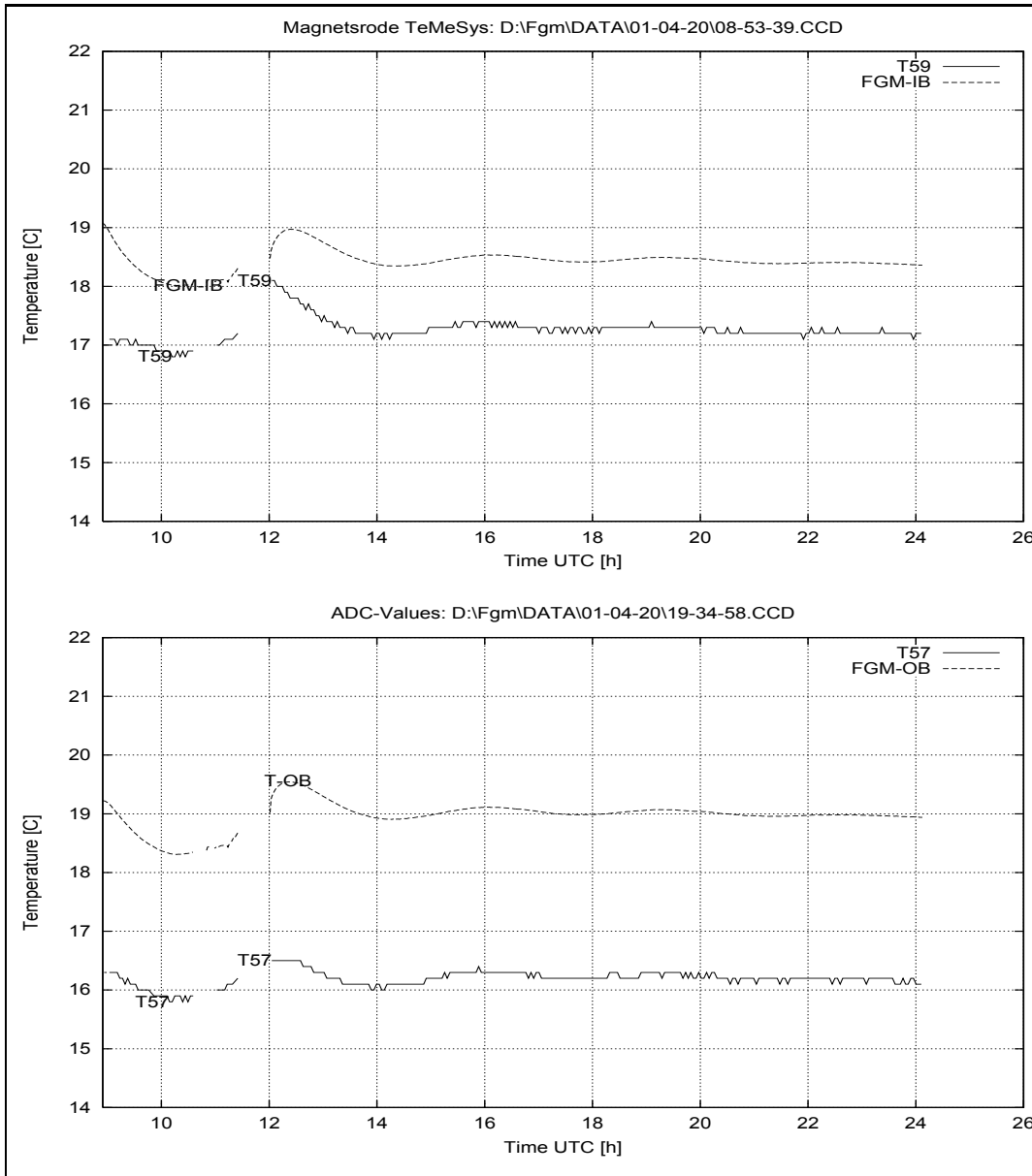

Figure 59: April 20, 2001: Sensor Temperatures at House 2.

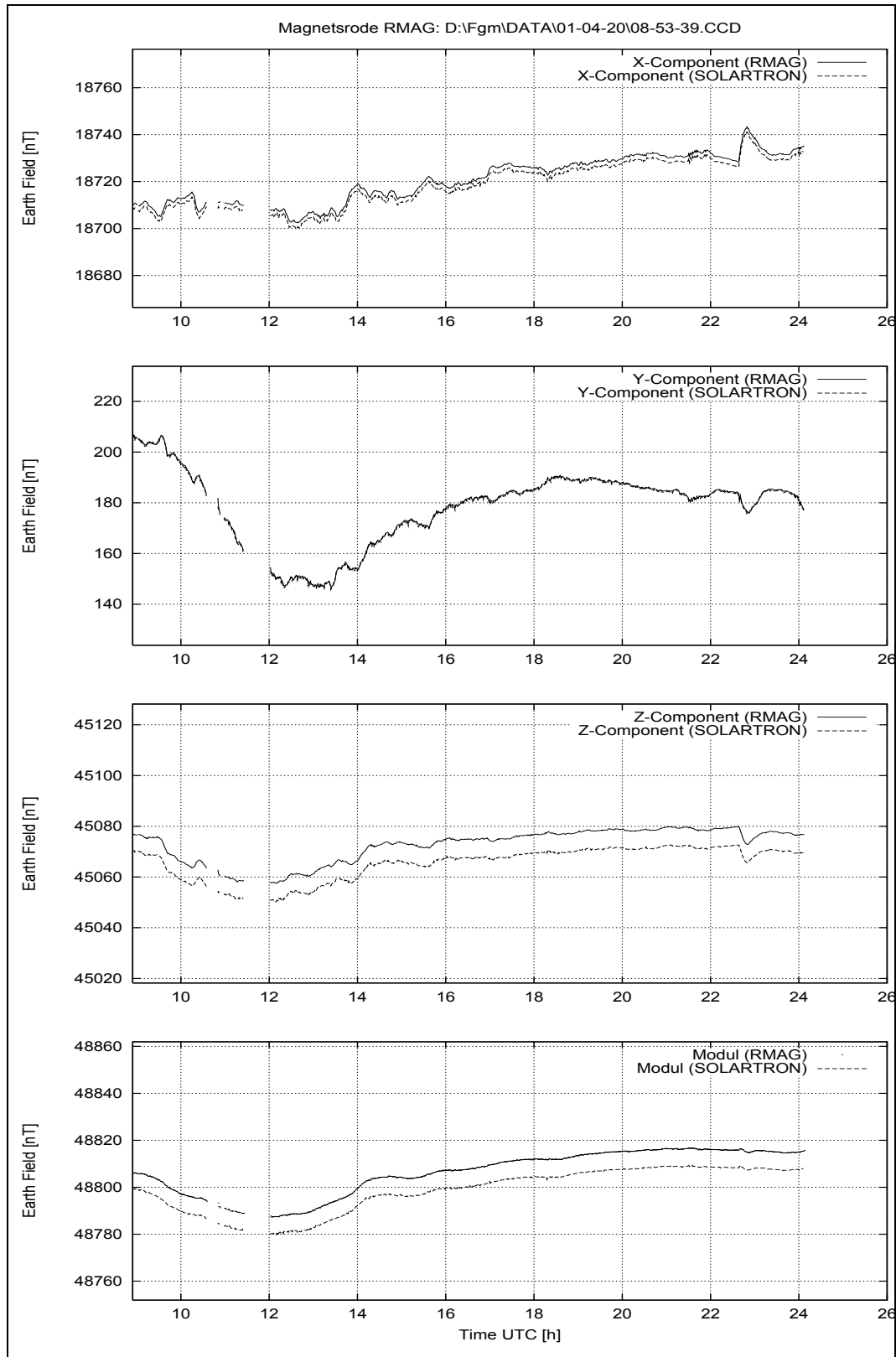

Figure 60: April 20, 2001: Earthfield variations.

R O S E T T A		Document: RO-IGM-TR-0002
		Issue: 2
		Revision: 2
IGM	Institut für Geophysik und Meteorologie Technische Universität Braunschweig	Date: October 10, 2001
		Page: 92

16 Saturday April 21, 2001

16.1 Linearity, Sensitivity and Cross Talk — DPU: FM, Sensors: FS-IB, Continued

The measurements in the optical aligned position proceeded over night and ended at 10:08.

16.1.1 Data

Configuration File	CCD File
LX15.CFG	01-04-21\00-07-39.CCD
LY15.CFG	01-04-21\00-38-39.CCD
LZ15.CFG	01-04-21\01-09-40.CCD
SP15spir.CFG	01-04-21\01-40-40.CCD
SP15sphe.CFG	01-04-21\05-33-42.CCD

After the data collection the setup was changed for the linearity measurements of the FS-OB sensor.

16.2 Linearity, Sensitivity and Cross Talk — DPU: FM, Sensors: FS-OB

The calibration mirror # OB was placed on the FS-OB sensor. After the optical alignment of the FS-OB sensor (refer to table 2 column #2) the linearity, sensitivity and cross talk measurements were initialised.

Purpose: Measure the linearity, sensitivity and cross talk data set
Conditions: FS-OB in optical aligned position at CoC
FS-IB south of CoC on aluminium support.
Refer to picture 247.
MAD: Ch0 to Ch2 connected to ZopfMag x to z, 10 nT/mV;
Ch7 FSP pulse;
Timer 500, SumUp 100, Vectorrate 1.00 Hz.
Files: M010421.SEQ
Start: 21.04.01 11:21
End: 23.04.01 06:36

R O S E T T A		Document: RO-IGM-TR-0002
		Issue: 2
		Revision: 2
IGM	Institut für Geophysik und Meteorologie Technische Universität Braunschweig	Date: October 10, 2001
		Page: 93

16.2.1 Data

Configuration File	CCD File
ALI10.cfg	01-04-21\11-21-57.CCD
LX15.CFG	01-04-21\11-29-19.CCD
LY15.CFG	01-04-21\12-00-20.CCD
LZ15.CFG	01-04-21\12-31-22.CCD
SP15spir.CFG	01-04-21\13-02-23.CCD
SP15sphe.CFG	01-04-21\16-55-08.CCD
LX15.CFG	01-04-21\21-27-48.CCD
LY15.CFG	01-04-21\21-58-48.CCD
LZ15.CFG	01-04-21\22-29-49.CCD
SP15spir.CFG	01-04-21\23-00-49.CCD

16.3 Overview Plots: System Performance, Temperatures and Earth-field Variations.

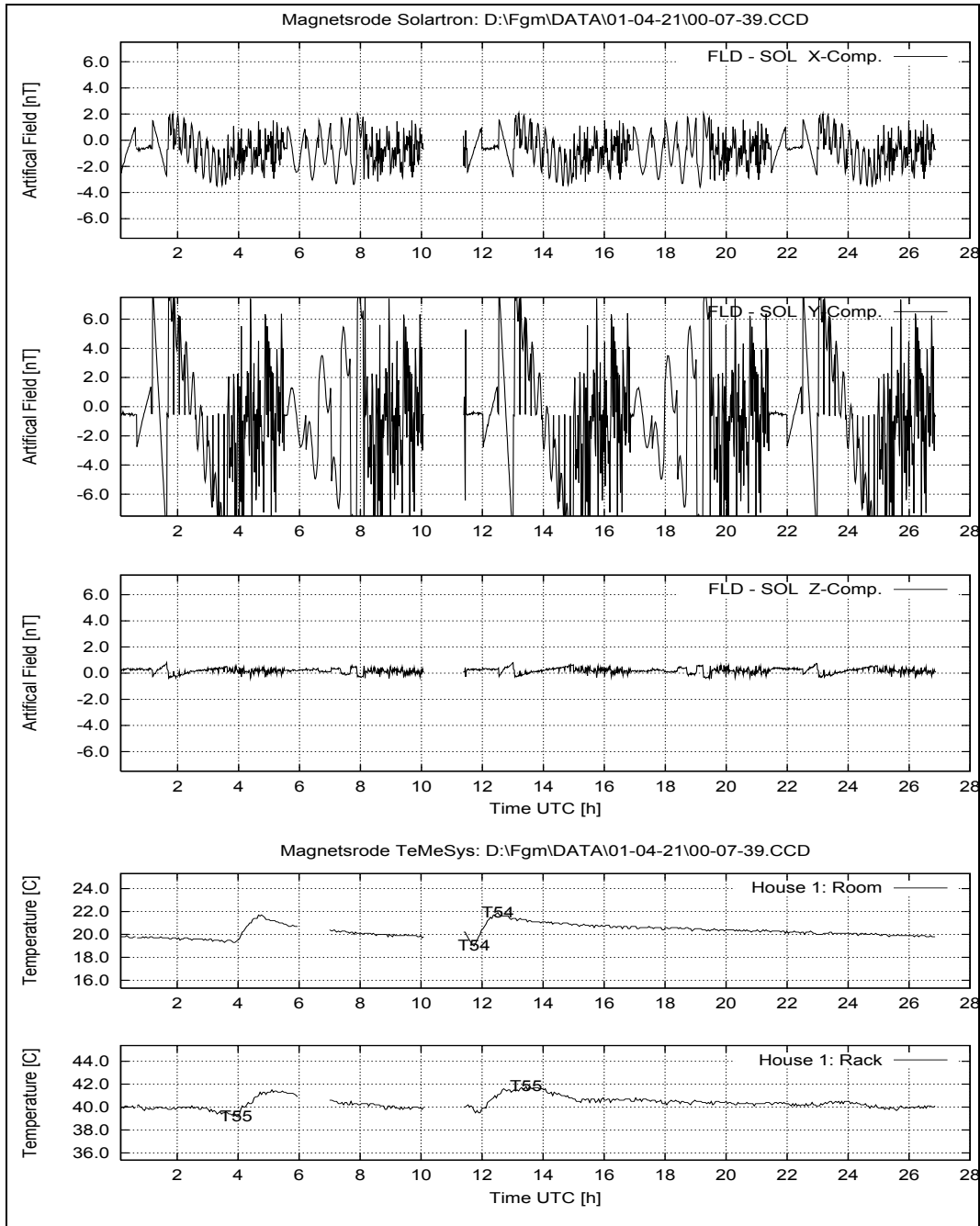

Figure 61: April 21, 2001: System Performance: FLD – SOL; Temperatures at House 1.

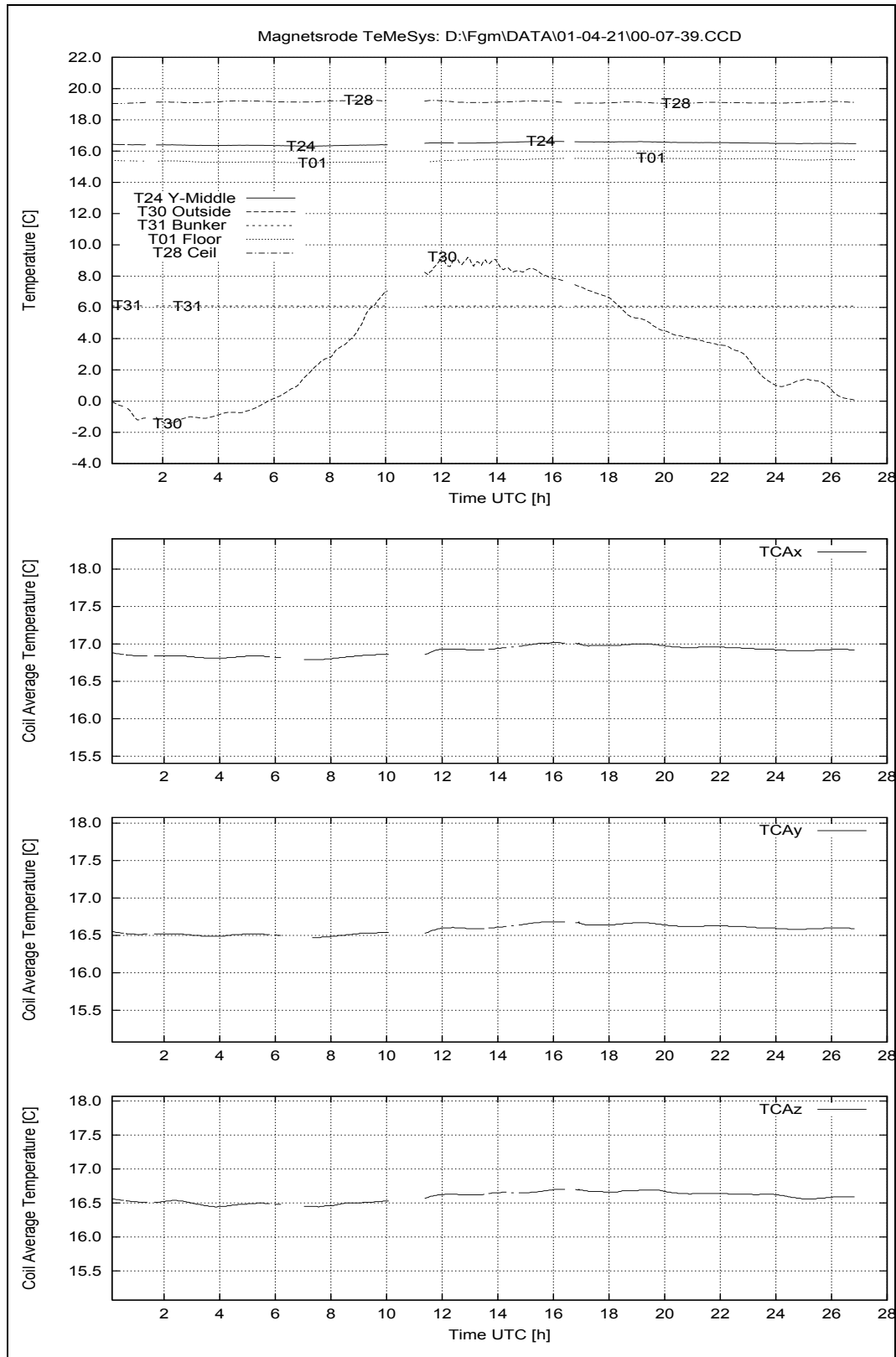

Figure 62: April 21, 2001: Temperatures House 2.

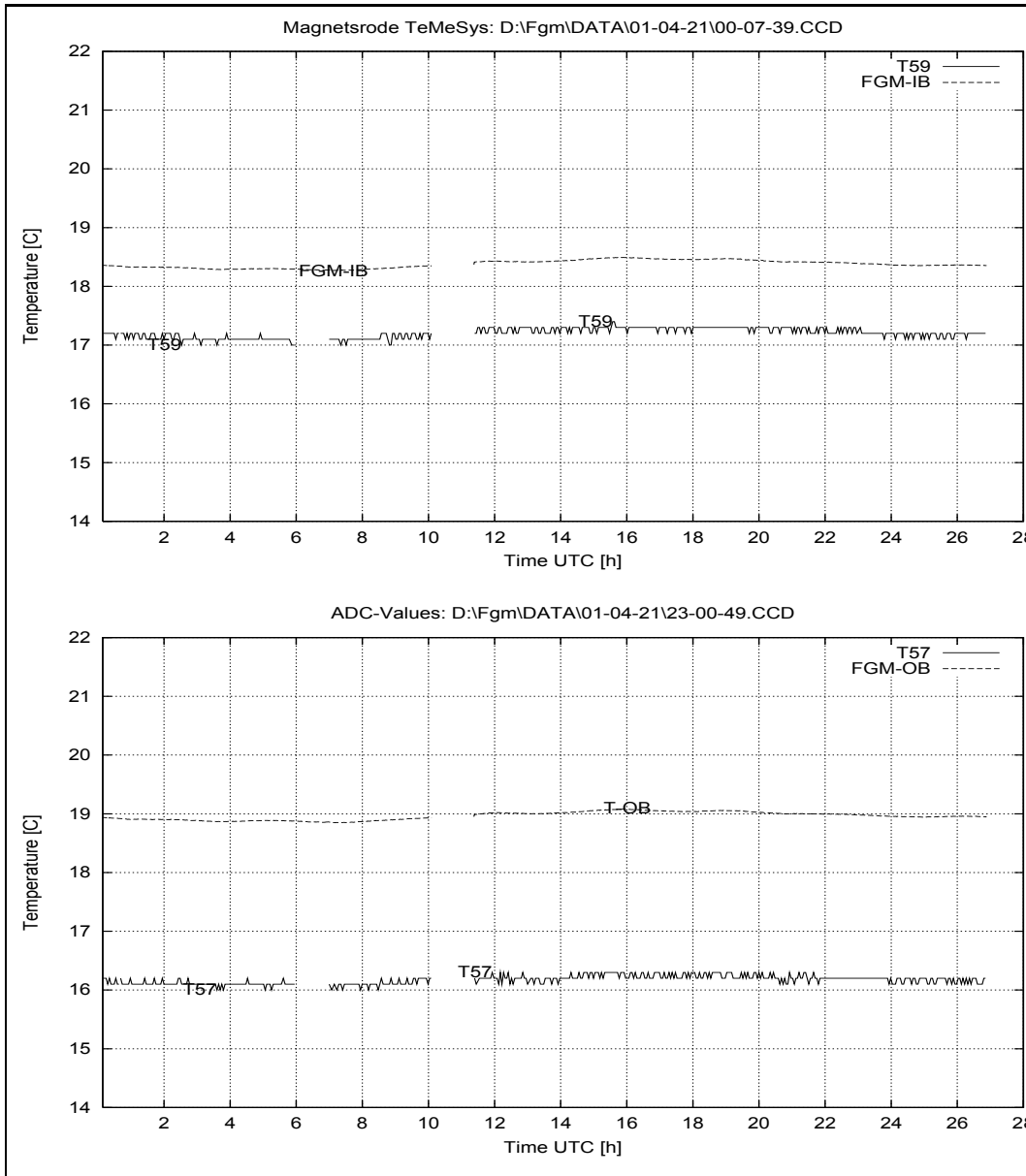

Figure 63: April 21, 2001: Sensor Temperatures at House 2.

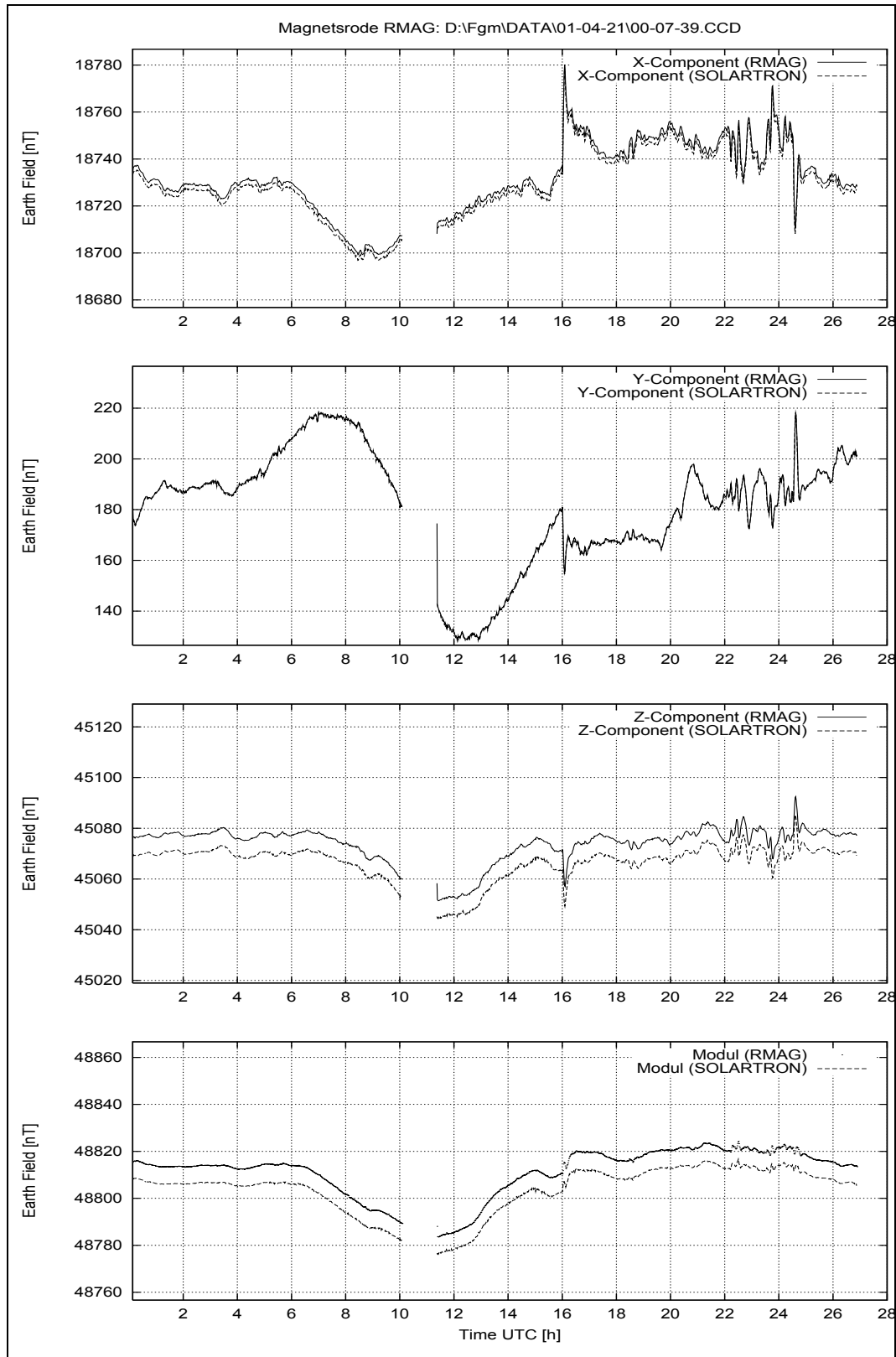

Figure 64: April 21, 2001: Earthfield variations.

R O S E T T A		Document: RO-IGM-TR-0002
		Issue: 2
		Revision: 2
IGM	Institut für Geophysik und Meteorologie	Date: October 10, 2001
	Technische Universität Braunschweig	Page: 98

17 Sunday April 22, 2001

The measurements on the OB sensor were executed automatically on this sunday. No personnel around today.

17.1 Linearity, Sensitivity and Cross Talk — DPU: FM, Sensors: FS-OB,Continued

In the early morning a spike sphere measurement was executed.

17.1.1 Data

Configuration File	CCD File
SP15sphe.CFG	01-04-22\02_53_34.CCD

Afterwards some earth field variation measurements were performed.

17.2 Earth Field Variation Check. DPU: FM, Sensors: FS-IB & FS-OB

The check is designed to investigate the regular registration of the two FGM sensors. The sensors are placed and fixed on the aluminium support on the open thermal test box plate (They have not been touched since the optical alignment of the FS-OB on Saturday.). The distance between them is 15 cm. The test has been performed with a fixed suppressed earth field.

Purpose: Earth field variation check.
Conditions: FS-OB and FS-IB placed in the Thermal Test Box on the aluminium support. The distance between them is 150 mm.
FS-OB optical aligned at CoC. FS-IB south of CoC.
MAD: Ch0 to Ch2 connected to Zopfmag x to z, 10 nT/mV;
Ch7 FSP;
File: Running M010422.CFG
Start: 22.04.01 07:26
End: 22.04.01 20:34

R O S E T T A		Document: RO-IGM-TR-0002
IGM Institut für Geophysik und Meteorologie Technische Universität Braunschweig		Issue: 2
		Revision: 2
		Date: October 10, 2001
		Page: 99

17.2.1 Data

Configuration File	CCD File	CCD File	Remarks
var.CFG	01-04-22\07_26_14.CCD		
var.CFG	01-04-22\08_26_55.CCD		
var.CFG	01-04-22\09_27_35.CCD		
var.CFG	01-04-22\10_28_16.CCD		
var.CFG	01-04-22\11_28_56.CCD		
var.CFG	01-04-22\12_29_37.CCD		
var.CFG	01-04-22\13_30_37.CCD		
var.CFG	01-04-22\14_31_17.CCD		
var.CFG	01-04-22\15_31_57.CCD		
var.CFG	01-04-22\16_32_38.CCD		
var.CFG	01-04-22\17_33_19.CCD		
var.CFG	01-04-22\18_34_00.CCD		
var.CFG	01-04-22\19_34_40.CCD		

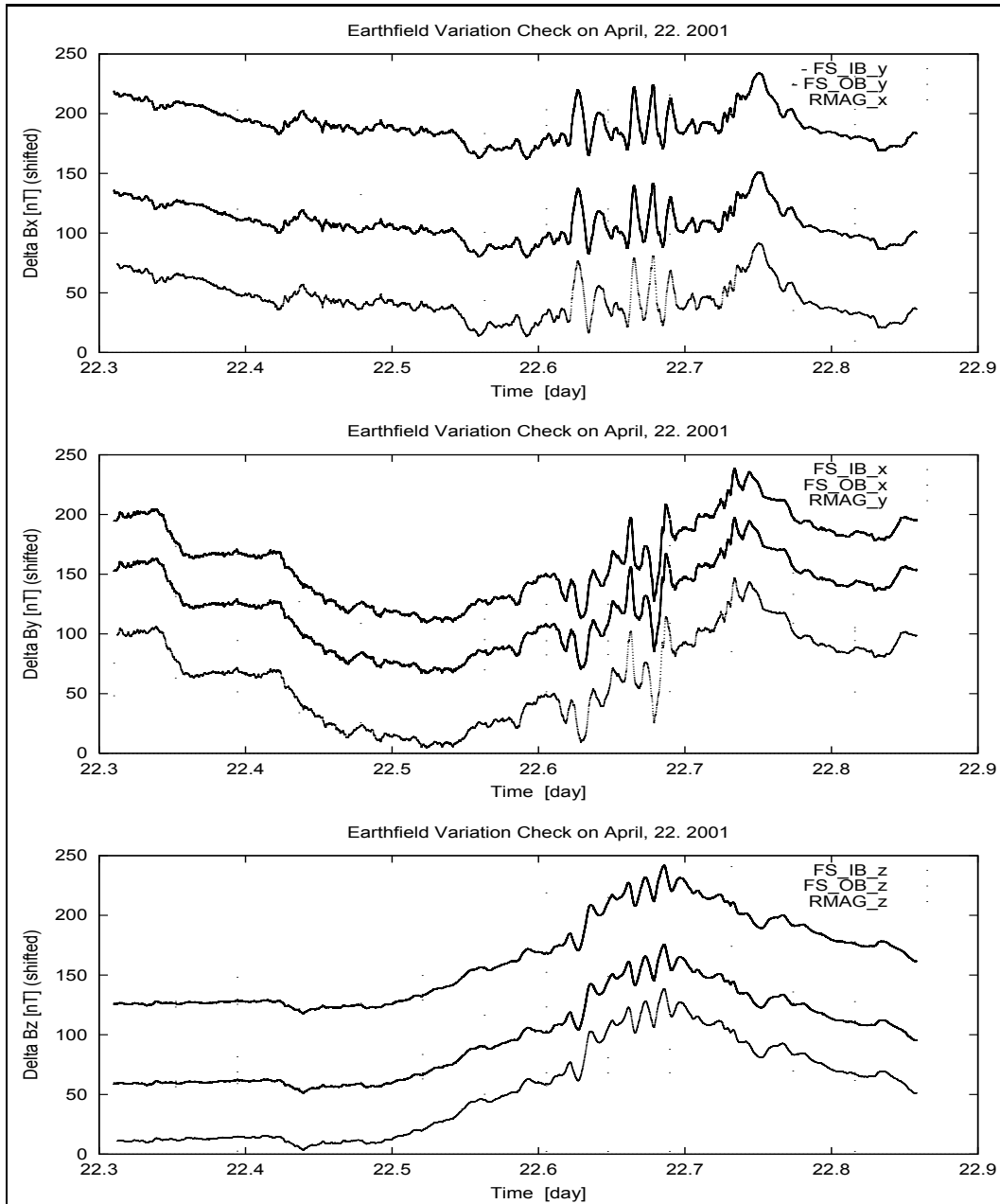

Figure 65: April, 22. 2001: Earth field variation Check

R O S E T T A		Document: RO-IGM-TR-0002
IGM Institut für Geophysik und Meteorologie Technische Universität Braunschweig		Issue: 2
		Revision: 2
		Date: October 10, 2001
		Page: 101

17.3 Linearity, Sensitivity and Cross Talk — DPU: FM, Sensors: FS-OB,Continued

After the earth field variation measurements have been finished the generated sequence continued and some linearity measurements were executed. The sensor setup is still unchanged. No personnel around.

17.3.1 Data

Configuration File	CCD File
LX15.CFG	01-04-22\20_35_21.CCD
LY15.CFG	01-04-22\21_06_22.CCD
LZ15.CFG	01-04-22\21_37_22.CCD
SP15spir.CFG	01-04-22\22_08_23.CCD

17.4 Overview Plots: System Performance, Temperatures and Earth-field Variations.

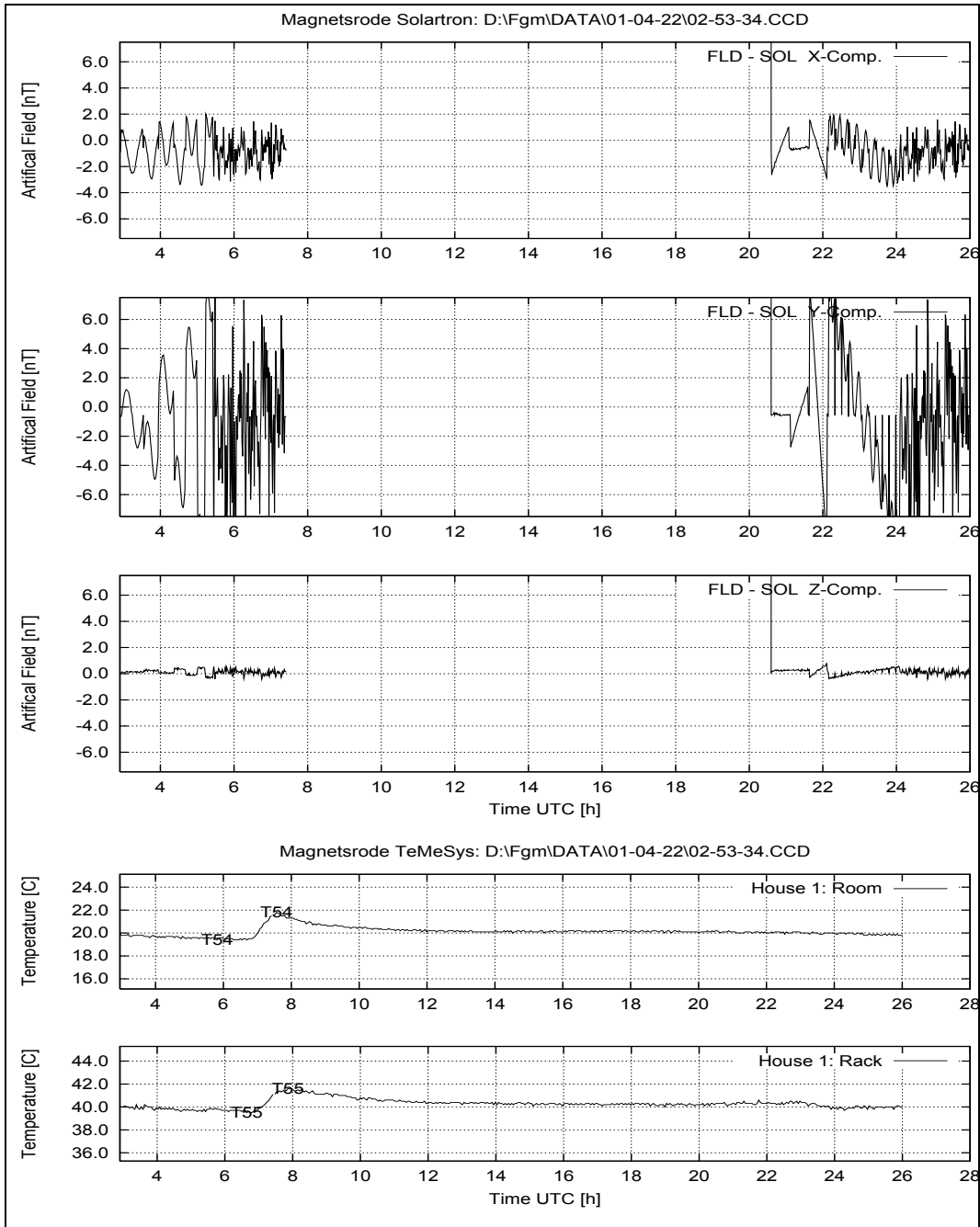

Figure 66: April 22, 2001: System Performance: FLD – SOL; Temperatures at House 1.

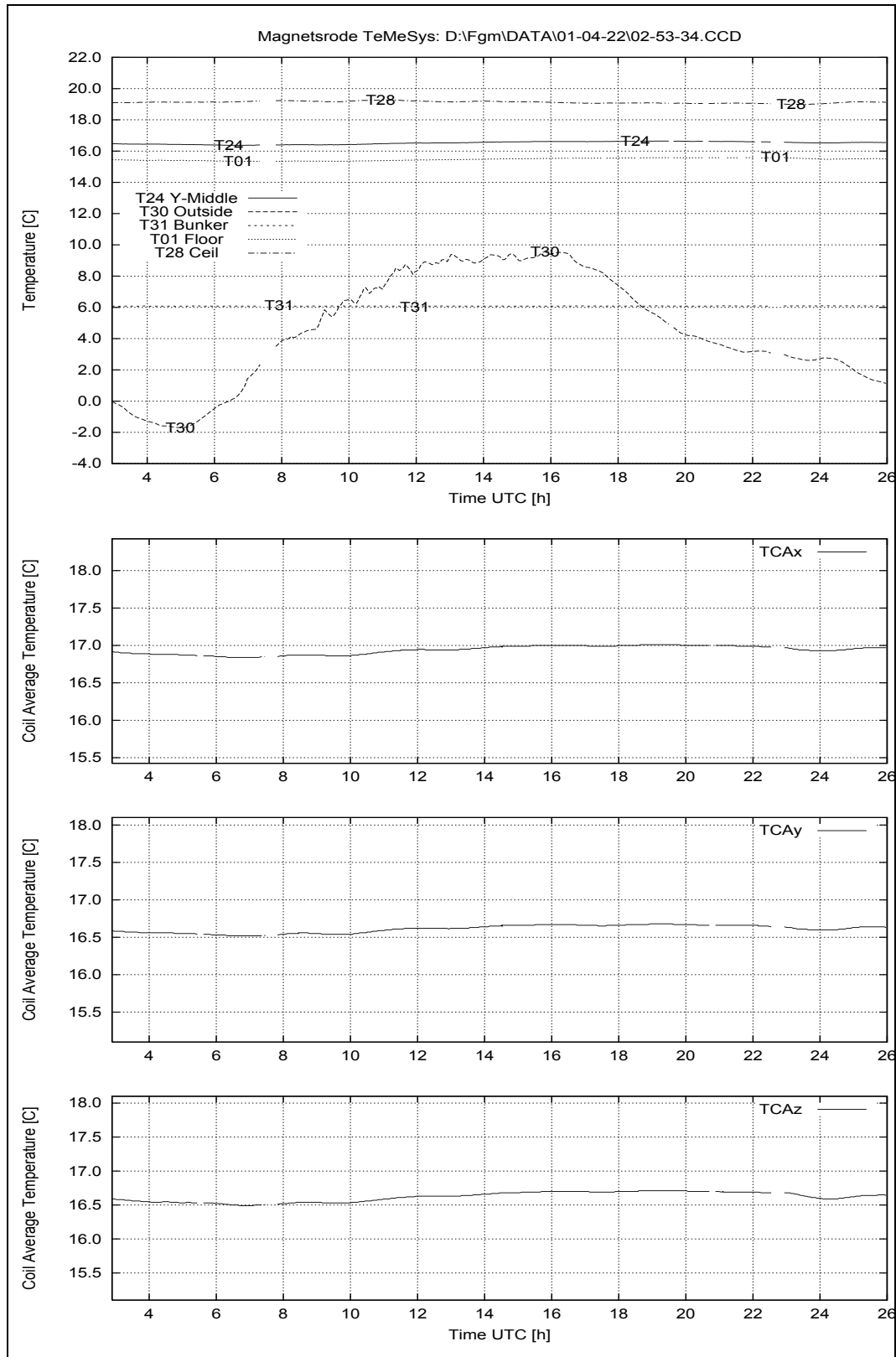

Figure 67: April 22, 2001: Temperatures House 2.

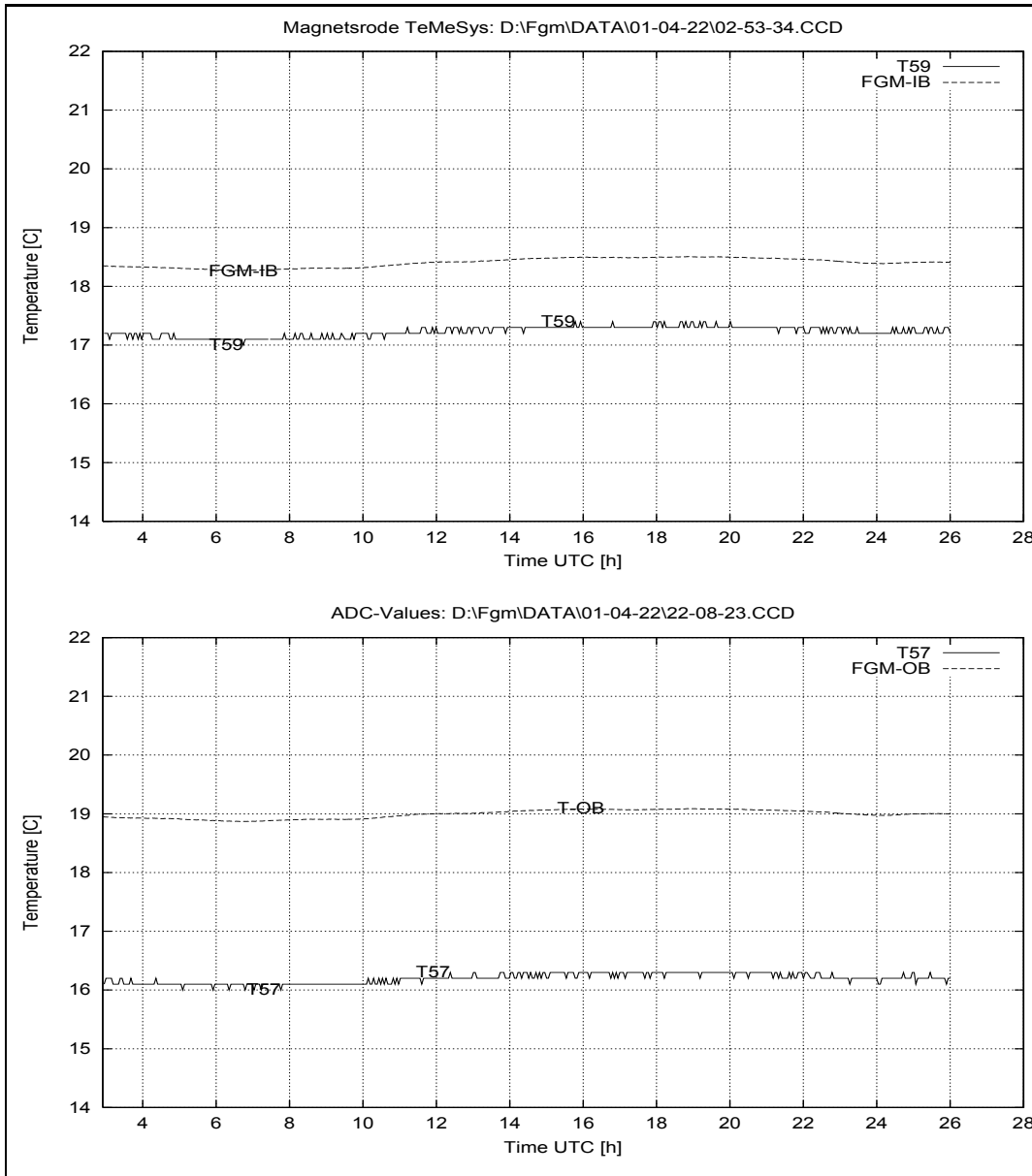

Figure 68: April 22, 2001: Sensor Temperatures at House 2.

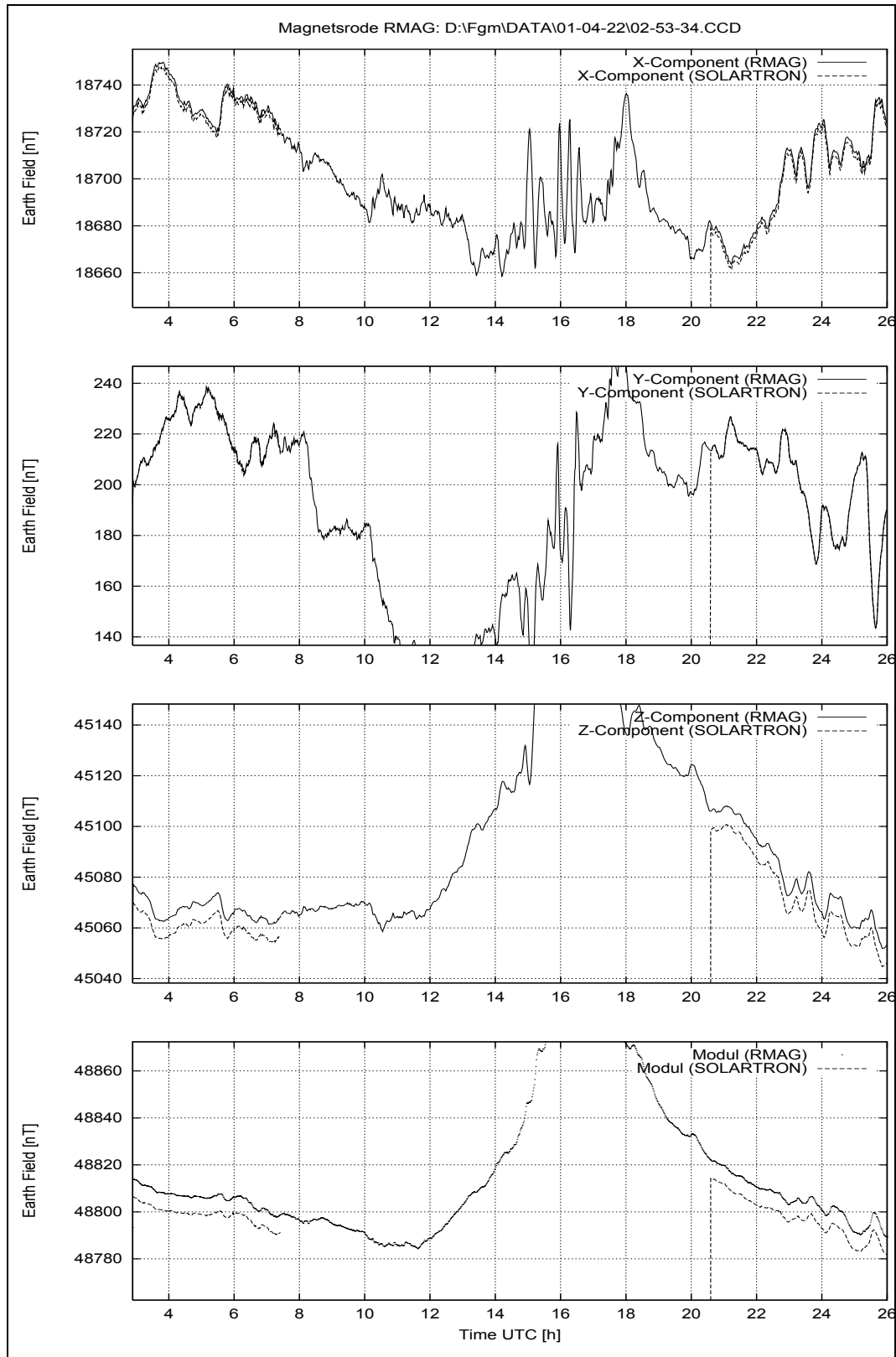

Figure 69: April 22, 2001: Earthfield variations.

R O S E T T A		Document: RO-IGM-TR-0002
		Issue: 2
		Revision: 2
IGM	Institut für Geophysik und Meteorologie	Date: October 10, 2001
	Technische Universität Braunschweig	Page: 106

18 Monday April 23, 2001

18.1 Linearity, Sensitivity and Cross Talk — DPU: FM, Sensors: FS-OB, Continued

The linearity measurements finished in the early morning hours.

18.1.1 Data

Configuration File	CCD File
SP15sphe.CFG	01-04-23\02_01_04.CCD

After these measurements the setup was changed for the frequency measurements.

18.2 Digital Frequency Response — DPU: FM, Sensors FS-IB & FS-OB

The digital frequency response function will be measured with two different amplitudes. For these chosen amplitudes the frequency will be discretely swept from 1000 Hz down to 100 mHz. The sensors were placed diagonal in space on the open Thermal Test Box mounting plate (refer to picture 248). The aluminium sensor support is elevated by 45° from the X_c - Y_c plane using the gray diagonal stand which is turned around Z_c by 54° . This is to get equal signals on all sensor components from the fields applied on the Y_c component. The measurements have been performed for both sensors in parallel.

Purpose: Measure the digital frequency response
Conditions: FS-IB & FS-OB placed diagonal in space in the coil system center.
FS-IB is the upper, FS-OB the lower one.
AC-Generator signal (AC2) applied to Y_c without attenuator.
MAD: Ch0 to Ch2 connected to Zopfmag x to z, 10 nT/mV;
Ch6 Generator signal (AC2) direct (no attenuation);
Ch7 FSP pulse;
Timer 500, SumUp 6, Vector Rate 16.67 Hz.
Files: F.SEQ
Start: 23.04.01 07:00
End: 23.04.01 08:41

R O S E T T A		Document: RO-IGM-TR-0002
		Issue: 2
		Revision: 2
IGM	Institut für Geophysik und Meteorologie	Date: October 10, 2001
	Technische Universität Braunschweig	Page: 107

18.2.1 Data

Configuration File	CCD File
ALI10.cfg	01-04-23\07_00_01.CCD
fd_h.CFG	01-04-23\07_07_33.CCD
fd_l.CFG	01-04-23\07_54_55.CCD

After the frequency measurements have been finished, the setup was changed to perform the offset measurements on the FS sensor connected to the FM DPU.

18.3 Offset Measurements — DPU: FM, Sensors FS-IB & FS-OB

To perform the offset measurements both sensors are mounted with their aluminium support at the stand on top of the green trolley. Figure 249 shows a photographic view of the setup in the normal position for the measurement of FS-OB. The following figures show the turned positions according to the test procedure.

Purpose: Measure the FS-IB & and FS-OB offset.
MAD: Ch0 to Ch2 connected to ZopfMag x to z, 10 nT/mV;
Ch7 FSP pulse;
Timer 500, SumUp 100, Vector rate 1.00 Hz.

PREMA:
Files: OFF?_?1.SEQ
Start: 23.04.01 08:53
End: 23.04.01 09:55

18.3.1 Data

Configuration File	CCD File	Position Picture
		Position 1: Normal OB @ CoC, height: 13cm, 010423B
ALI10.cfg	01-04-23\08_53_30.CCD	
offx_n1.CFG	01-04-23\09_01_01.CCD	
Configuration File	CCD File	Position Picture
		Position 2: Normal IB @ CoC, height: 13cm, No Photo
offx_n1.CFG	01-04-23\09_04_58.CCD	

R O S E T T A		Document: RO-IGM-TR-0002
		Issue: 2
		Revision: 2
IGM	Institut für Geophysik und Meteorologie Technische Universität Braunschweig	Date: October 10, 2001
		Page: 108

Configuration File	CCD File	Position Picture
		Position 3: Turned @ \Zc 0B @ CoC, height: 13cm, 010423C
ALI10.cfg	01-04-23\09_10_36.CCD	
offx_t1.CFG	01-04-23\09_17_46.CCD	

Configuration File	CCD File	Position Picture
		Position 4: Turned @ \Zc IB @ CoC, height: 13cm, No Photo
offx_t1.CFG	01-04-23\09_24_30.CCD	

Configuration File	CCD File	Position Picture
		Position 5: Turned @ \Yc 0B @ CoC, height: 20cm, 010423D
ALI10.cfg	01-04-23\09_34_59.CCD	
offz_t1.CFG	01-04-23\09_42_09.CCD	

Configuration File	CCD File	Position Picture
		Position 6: Turned @ \Yc IB @ CoC, height: 20cm, No Photo
offz_t1.CFG	01-04-23\09_49_30.CCD	

After the successful executed offset measurement of the FS sensor with the FM DPU we changed the setup to perform linearity measurements in the combination **FS DPU with the FS Sensors**.

18.4 Linearity, Sensitivity and Cross Talk — DPU: FS, Sensors: FS-IB

The calibration mirror #IB was placed on the FS-IB sensor. After the optical alignment of the FS-IB sensor (refer to table 2 column #3) the linearity, sensitivity and cross talk measurements were initialised.

Purpose: Measure the linearity, sensitivity and cross talk data set
Conditions: FS-IB in optical aligned position at CoC
FS-OB north of CoC on aluminium support.
Refer to picture 253.
MAD: Ch0 to Ch2 connected to ZopfMag x to z, 10 nT/mV;
Ch7 FSP pulse;
Timer 500, SumUp 100, Vectorrate 1.00 Hz.
Files: M010423.SEQ
Start: 23.04.01 10:25
End: 24.04.01 08:36

18.4.1 Data

Configuration File	CCD File
ALI10.cfg	01-04-23\10_25_59.CCD
STABTST.cfg	01-04-23\10_33_31.CCD
STABTST.cfg	01-04-23\11_34_11.CCD
LX15.CFG	01-04-23\12_34_52.CCD
LY15.CFG	01-04-23\13_06_15.CCD
LZ15.CFG	01-04-23\13_37_46.CCD
SP15spir.CFG	01-04-23\14_09_10.CCD
SP15sphe.CFG	01-04-23\18_01_54.CCD
LX15.CFG	01-04-23\22_34_36.CCD
LY15.CFG	01-04-23\23_05_35.CCD
LZ15.CFG	01-04-23\23_36_35.CCD

18.5 Overview Plots: System Performance, Temperatures and Earth-field Variations.

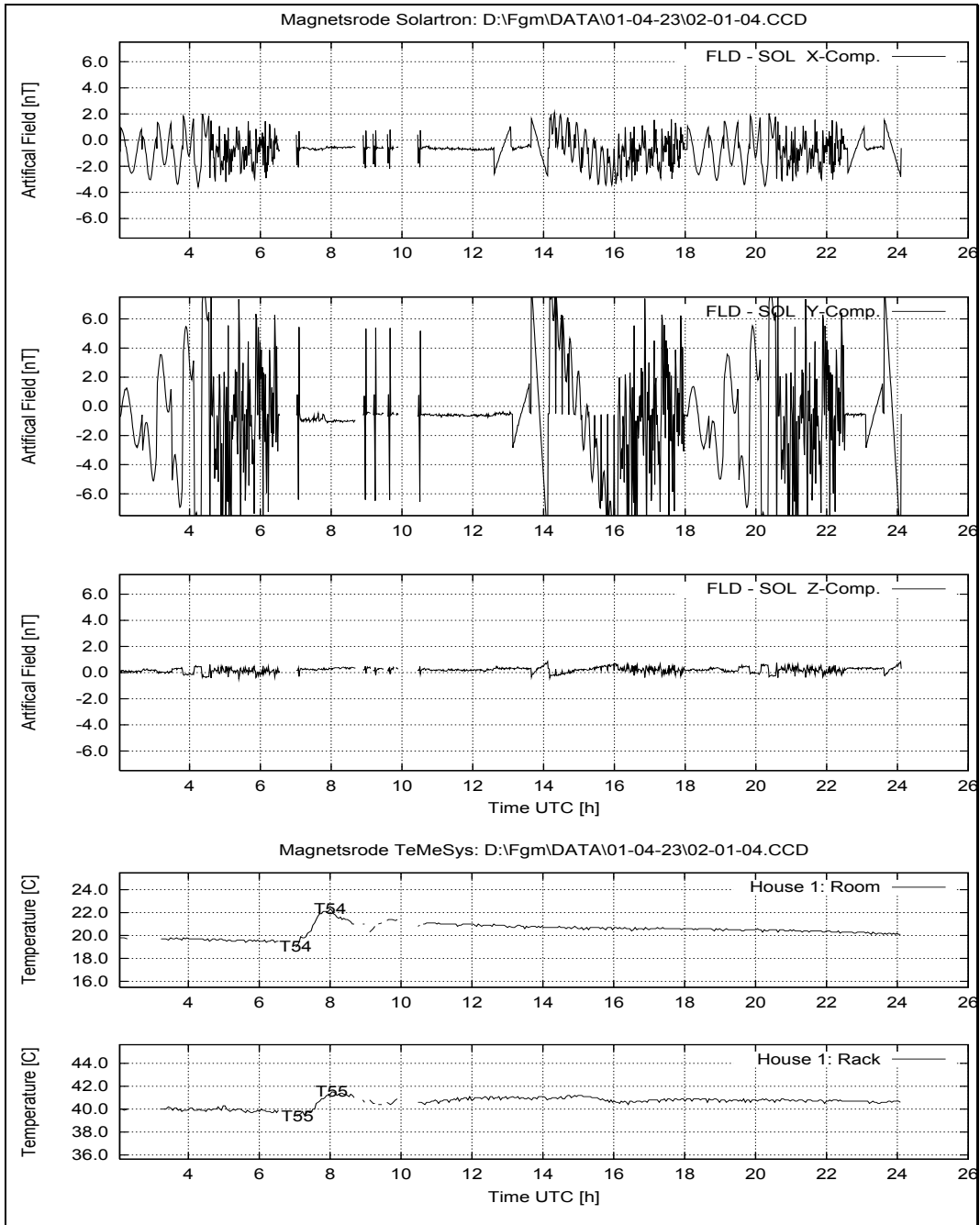

Figure 70: April 23, 2001: System Performance: FLD – SOL; Temperatures at House 1.

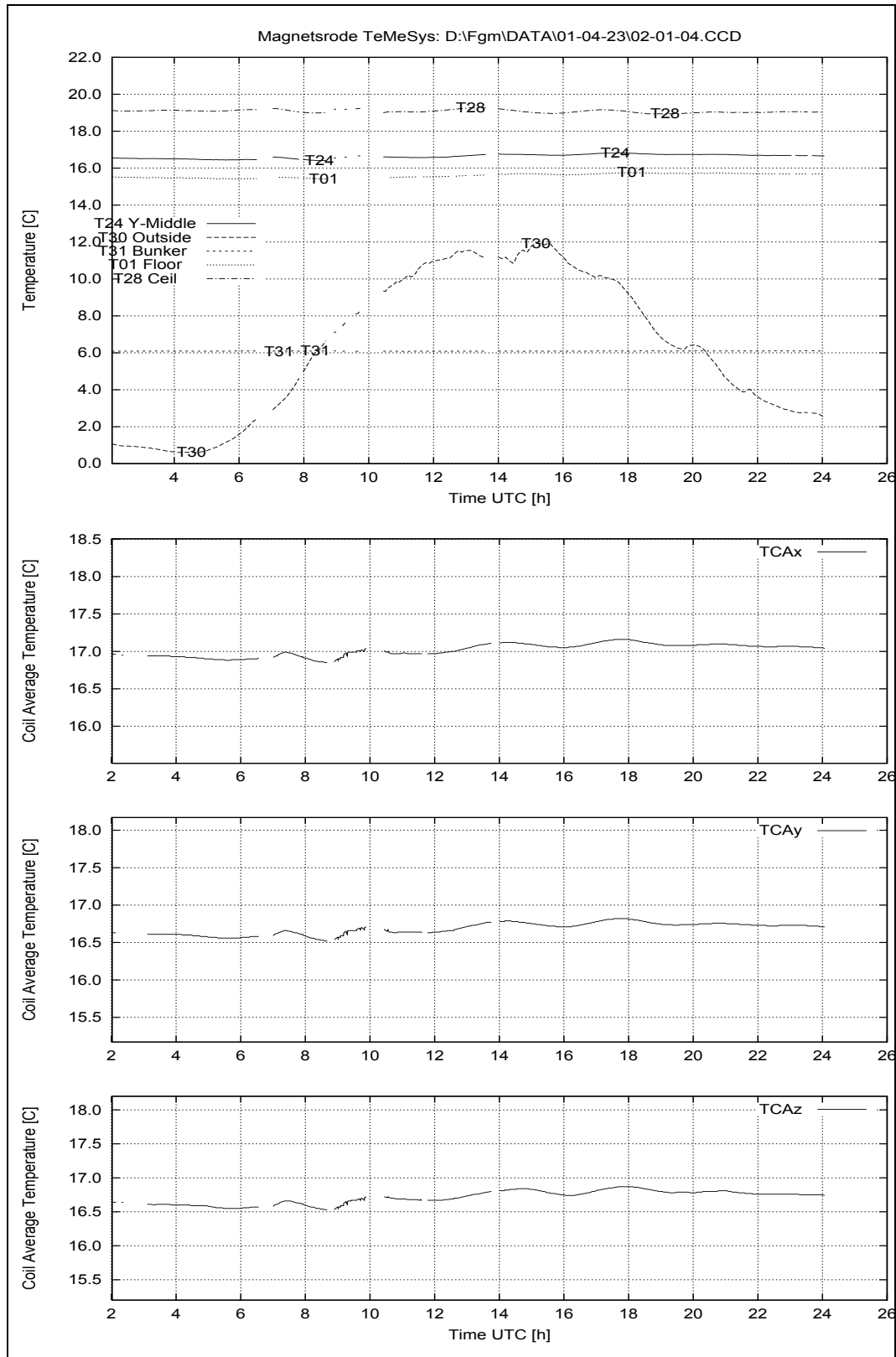

Figure 71: April 23, 2001: Temperatures House 2.

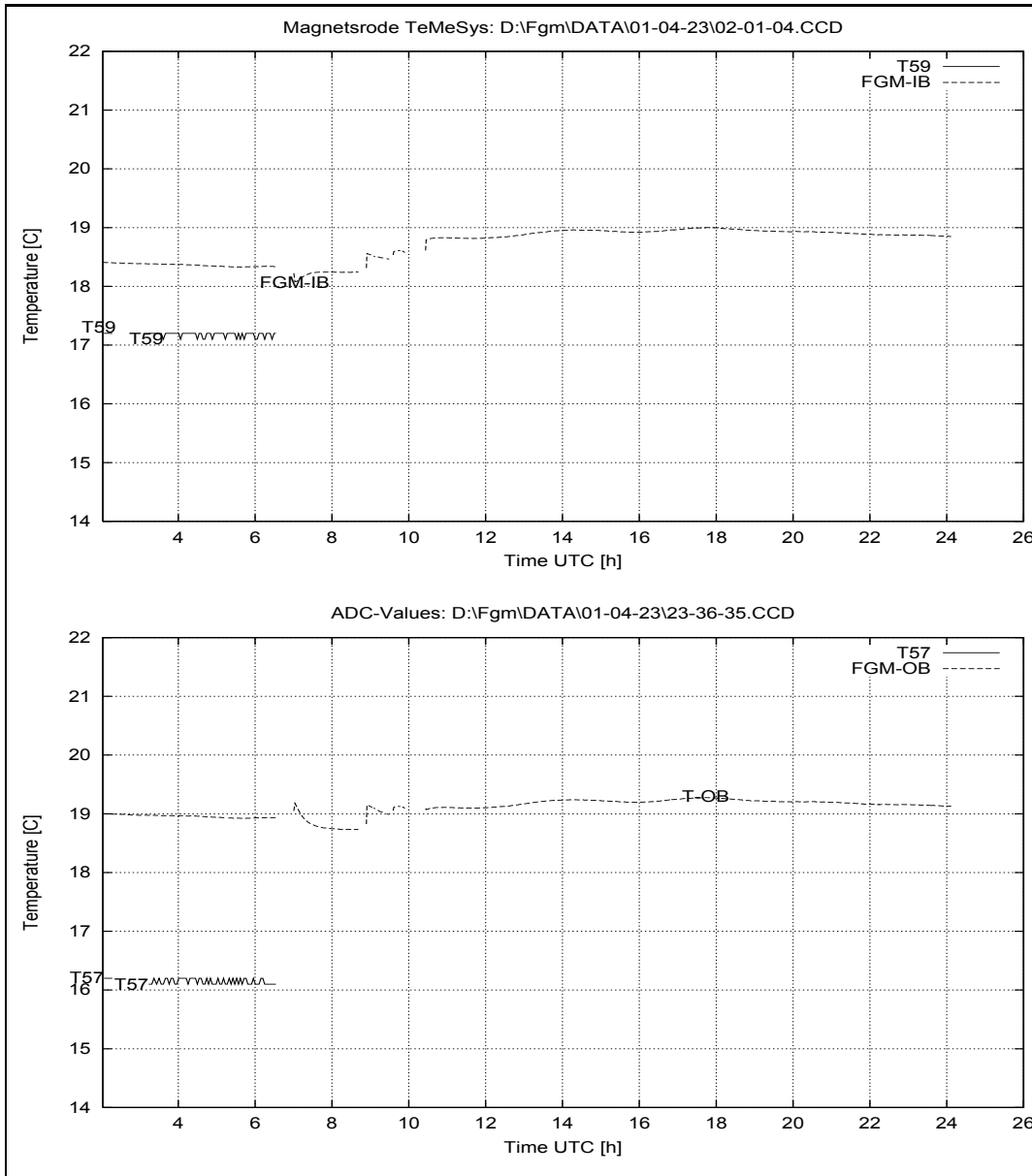

Figure 72: April 23, 2001: Sensor Temperatures at House 2.

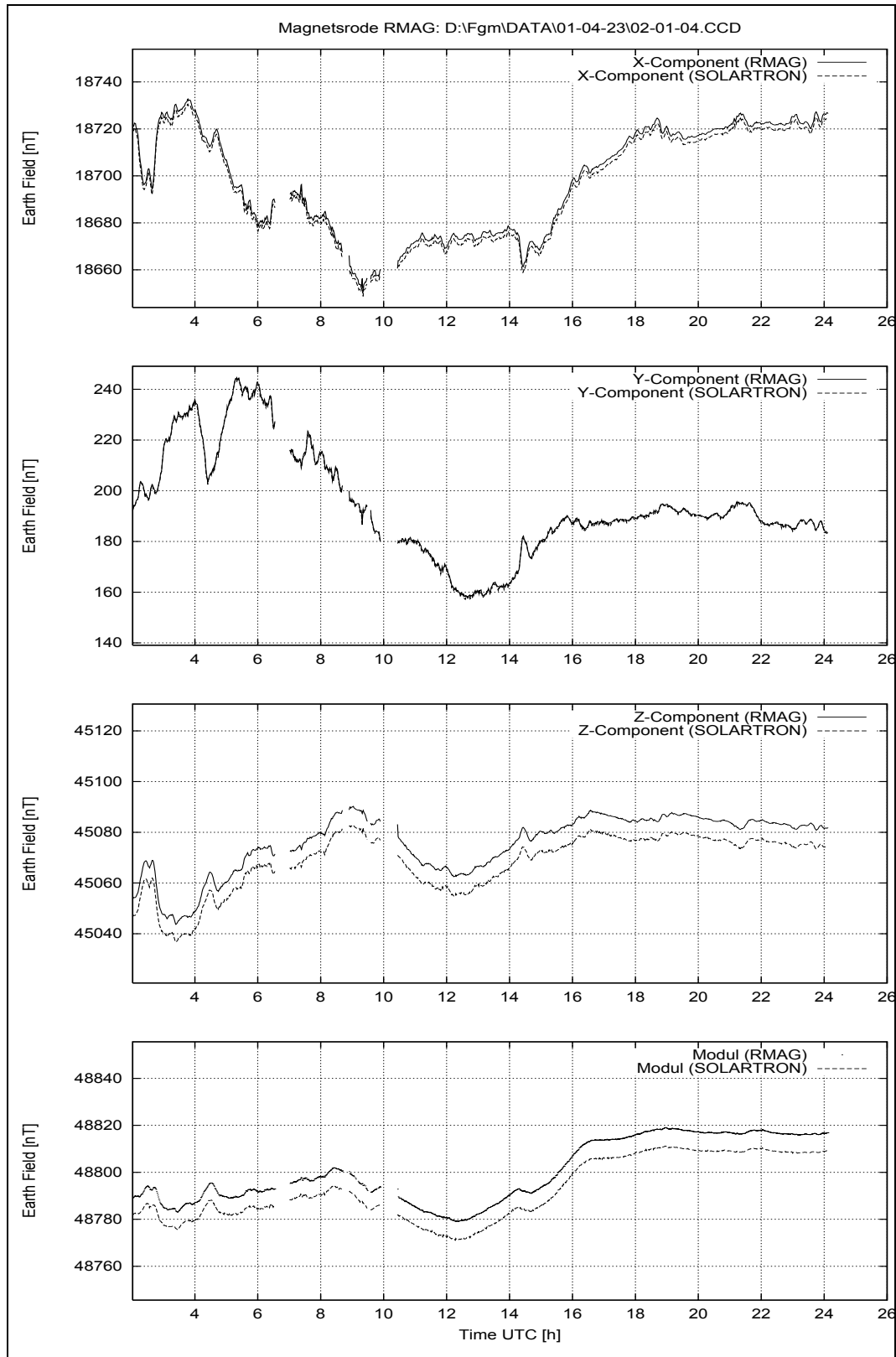

Figure 73: April 23, 2001: Earthfield variations.

R O S E T T A		Document: RO-IGM-TR-0002
		Issue: 2
		Revision: 2
IGM	Institut für Geophysik und Meteorologie	Date: October 10, 2001
	Technische Universität Braunschweig	Page: 114

19 Tuesday April 24, 2001

19.1 Linearity, Sensitivity and Cross Talk — DPU: FS, Sensors: FS-IB, Continued

The missing two measurements of the actual linearity sequence were performed in the early morning hours.

19.1.1 Data

Configuration File	CCD File
SP15spir.CFG	01-04-24\00_07_37.CCD
SP15sphe.CFG	01-04-24\04_00_21.CCD

After the IB measurements the missing OB measurements were performed.

19.2 Linearity, Sensitivity and Cross Talk — DPU: FS, Sensors: FS-OB

The calibration mirror #OB was placed on the FS-OB sensor. After the optical alignment of the FS-OB sensor (refer to table 2 column #4) the linearity, sensitivity and cross talk measurements were initialised.

Purpose: Measure the linearity, sensitivity and cross talk data set
Conditions: FS-OB in optical aligned position at CoC
FS-IB south of CoC on aluminium support.
Refer to picture 255.
MAD: Ch0 to Ch2 connected to ZopfMag x to z, 10 nT/mV;
Ch7 FSP pulse;
Timer 500, SumUp 100, Vectorrate 1.00 Hz.
Files: M010424.SEQ
Start: 24.04.01 11:22
End: 25.04.01 09:32

19.2.1 Data

Configuration File	CCD File
ALI10.cfg	01-04-24\11_22_15.CCD
STABTST.cfg	01-04-24\11_29_38.CCD
STABTST.cfg	01-04-24\12_30_17.CCD
LX15.CFG	01-04-24\13_30_57.CCD
LY15.CFG	01-04-24\14_01_58.CCD
LZ15.CFG	01-04-24\14_32_59.CCD
SP15spir.CFG	01-04-24\15_03_59.CCD
SP15sphe.CFG	01-04-24\18_56_42.CCD
LX15.CFG	01-04-24\23_29_22.CCD

19.3 Overview Plots: System Performance, Temperatures and Earth-field Variations.

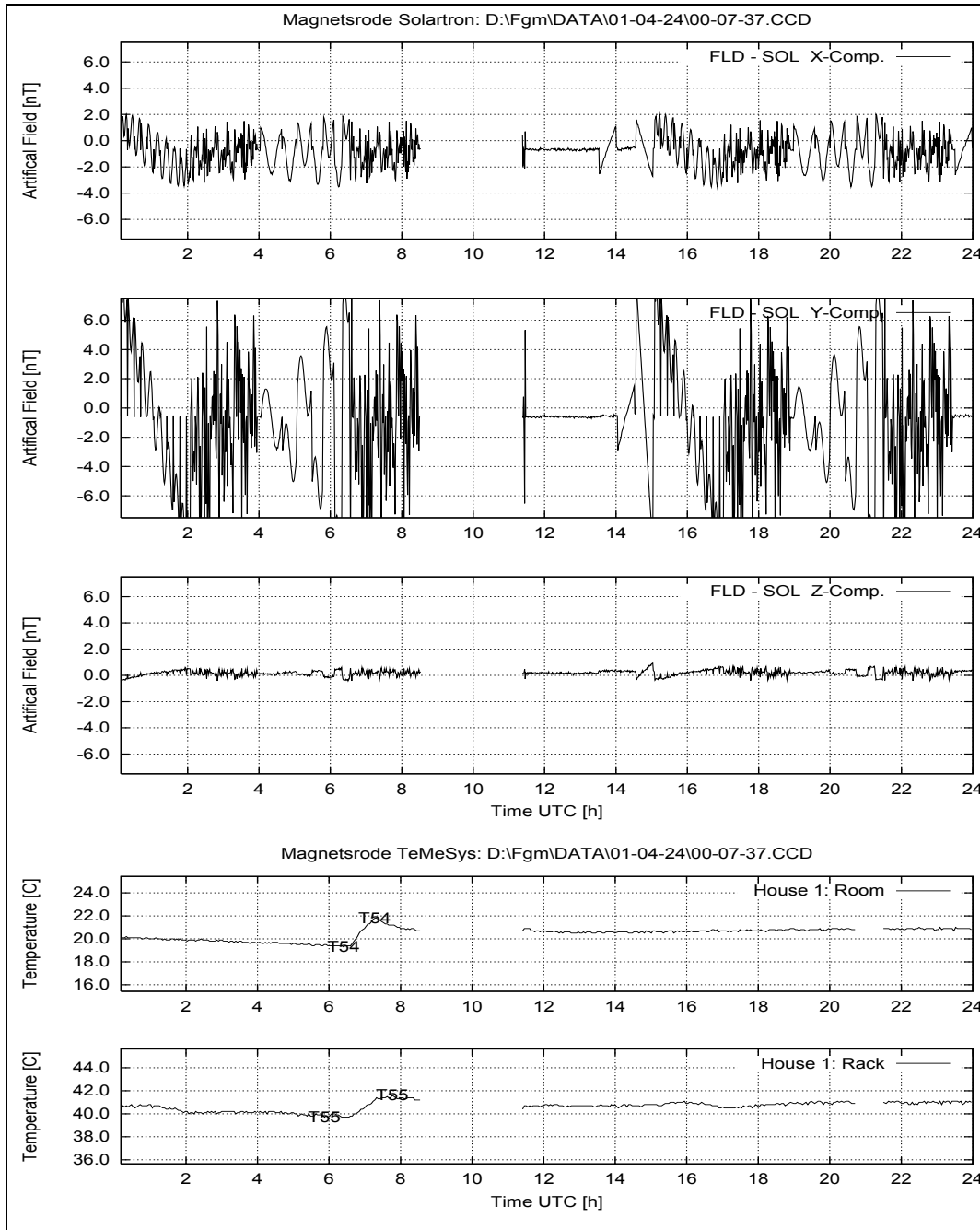

Figure 74: April 24, 2001: System Performance: FLD – SOL; Temperatures at House 1.

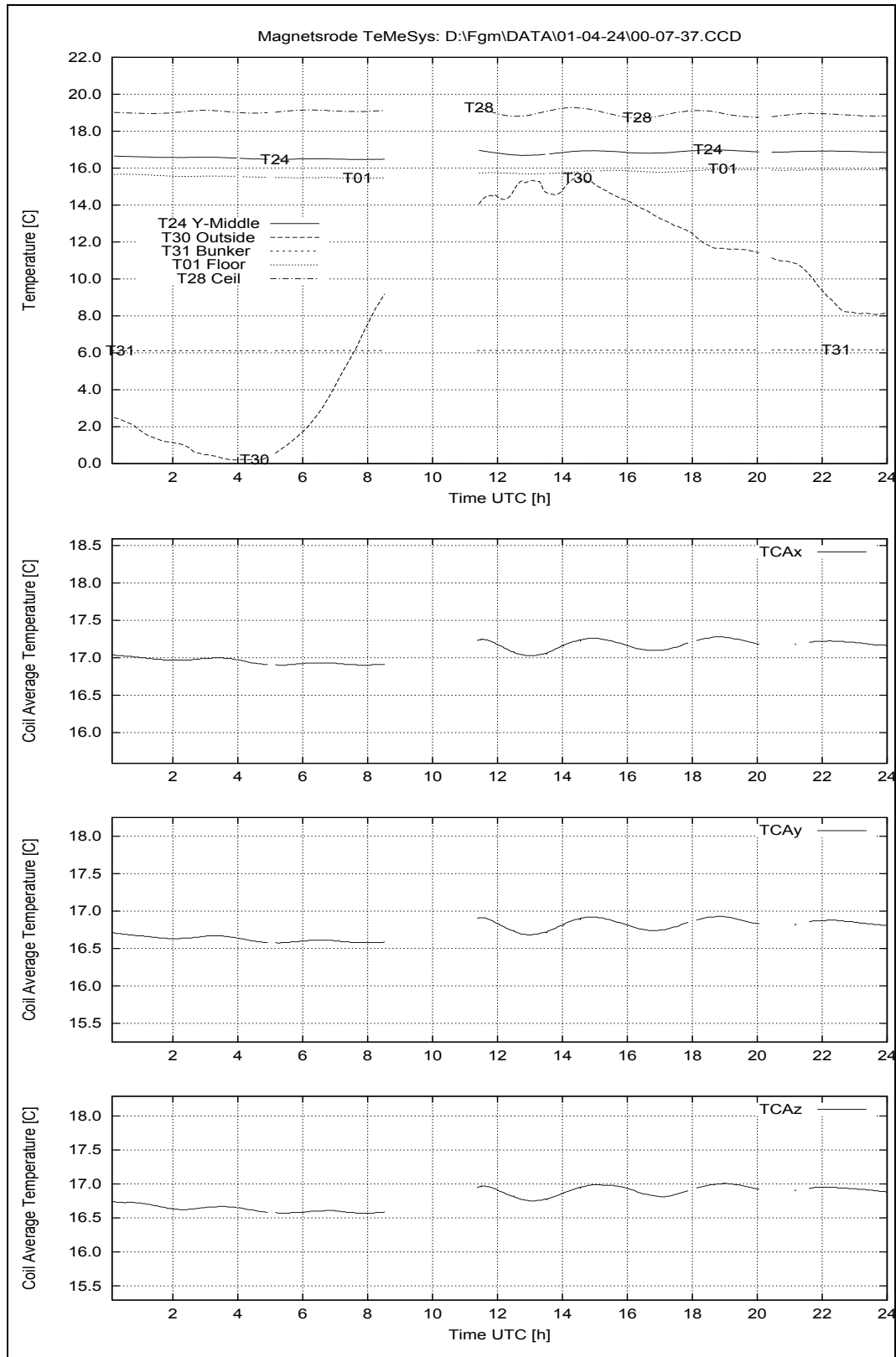

Figure 75: April 24, 2001: Temperatures House 2.

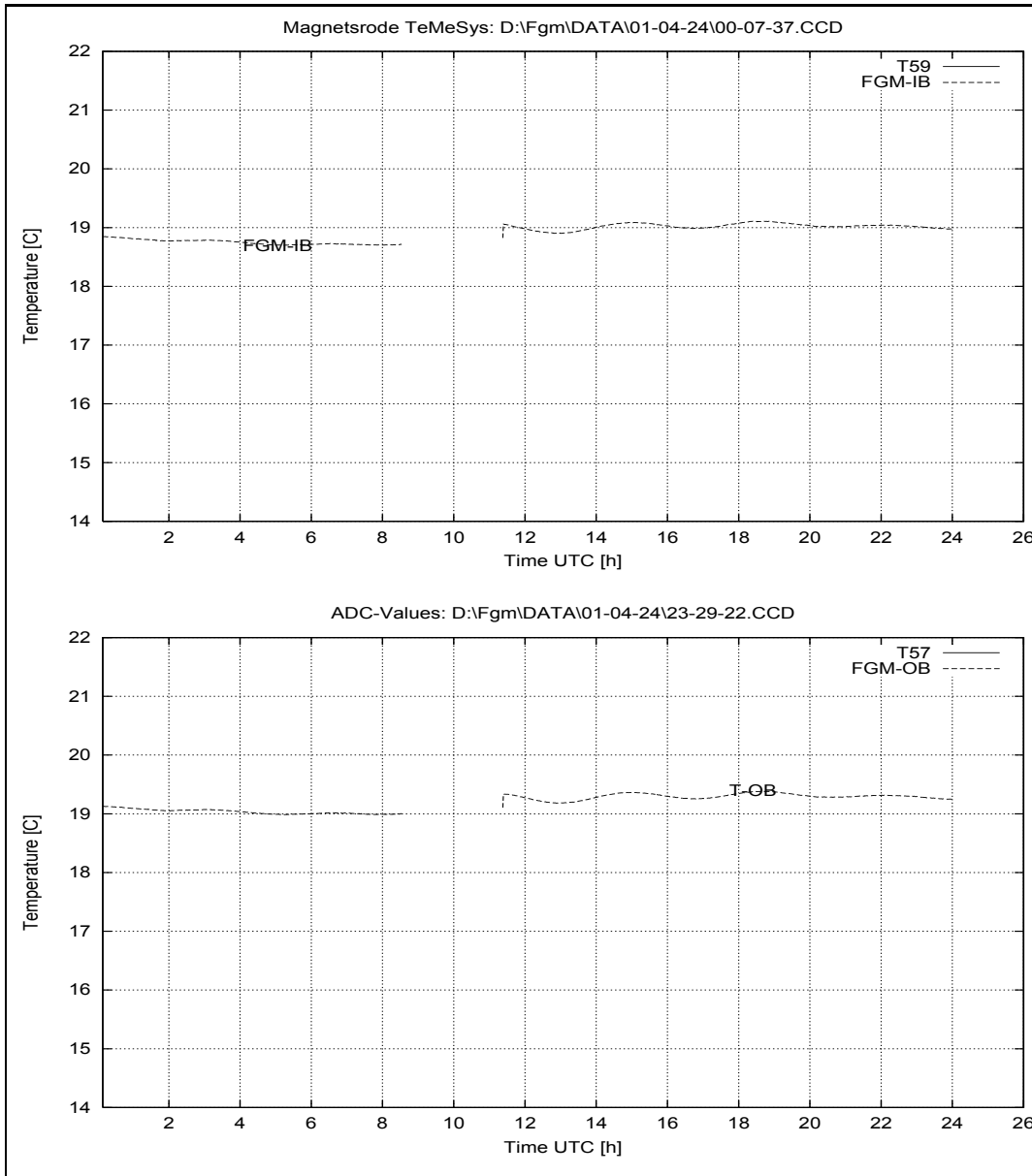

Figure 76: April 24, 2001: Sensor Temperatures at House 2.

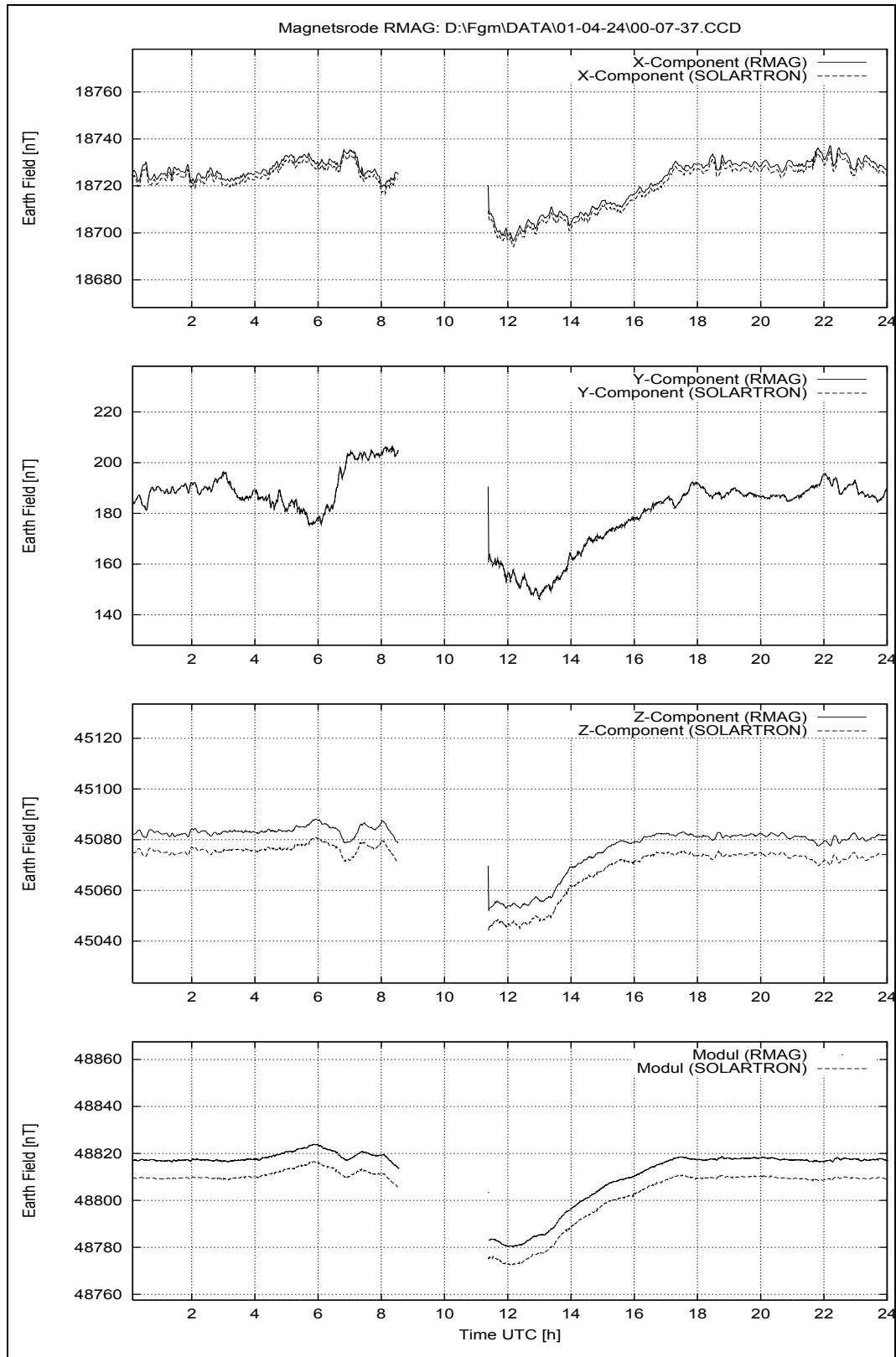

Figure 77: April 24, 2001: Earthfield variations.

R O S E T T A		Document: RO-IGM-TR-0002
		Issue: 2
		Revision: 2
IGM	Institut für Geophysik und Meteorologie	Date: October 10, 2001
	Technische Universität Braunschweig	Page: 120

20 Wednesday April 25, 2001

20.1 Linearity, Sensitivity and Cross Talk — DPU: FS, Sensors: FS-OB, Continued

The missing measurements of the linearity sequence were performed in the early morning hours.

20.1.1 Data

Configuration File	CCD File
LY15.CFG	01-04-25\00_00_24.CCD
LZ15.CFG	01-04-25\00_31_24.CCD
SP15spir.CFG	01-04-25\01_02_24.CCD
SP15sphe.CFG	01-04-25\04_55_08.CCD

After these measurements the setup was changed for the frequency measurements.

20.2 Digital Frequency Response — DPU: FS, Sensors FS-IB & FS-OB, Failed

The digital frequency response function will be measured with two different amplitudes. For these chosen amplitudes the frequency will be discretely swept from 1000 Hz down to 100 mHz. The sensors were placed diagonal in space on the open Thermal Test Box mounting plate (refer to picture 256). The aluminium sensor support is elevated by 45° from the X_C - Y_C plane using the gray diagonal stand which is turned around Z_C by 54° . This is to get equal signals on all sensor components from the fields applied on the Y_C component. The measurements were performed for both sensors in parallel.

Purpose: Measure the digital frequency response
Conditions: FS-IB & FS-OB placed diagonal in space in the coil system center.
FS-IB is the upper, FS-OB the lower one.
AC-Generator signal (AC2) applied to Y_C without attenuator.
MAD: Ch0 to Ch2 connected to Zopfmag x to z, 10 nT/mV;
Ch6 Generator signal (AC2) direct (no attenuation);
Ch7 FSP pulse;
Timer 500, SumUp 6, Vector Rate 16.67 Hz.
Files: F.SEQ
Start: 25.04.01 11:20
End: 25.04.01 13:02
REMARK: The 50Ω Terminator on the Y_C input was NOT applied.

20.2.1 Data

Configuration File	CCD File
ALI10.cfg	01-04-25\11_20_48.CCD
fd_h.CFG	01-04-25\11_28_26.CCD
fd_l.CFG	01-04-25\12_15_47.CCD

After the frequency measurements have been finished, the setup was changed to perform the offset measurements on the FS sensor connected to the FS DPU. The failed frequency measurements will be repeated afterwards.

20.3 Offset Measurements — DPU: FS, Sensors FS-IB & FS-OB

To perform the offset measurements both sensors are mounted with their aluminium support at the stand on top of the green trolley. Figure 257 shows a photographic view of the setup in the normal position for the measurement of FS-OB. The following figures show the turned positions according to the test procedure.

Purpose: Measure the FS-IB & and FS-OB offset.
MAD: Ch0 to Ch2 connected to ZopfMag x to z, 10 nT/mV;
Ch7 FSP pulse;
Timer 500, SumUp 100, Vector rate 1.00 Hz.

PREMA:
Files: OFF?_?1.SEQ
Start: 25.04.01 13:19
End: 25.04.01 14:23

20.3.1 Data

Configuration File	CCD File	Position Picture
		Position 1: Normal OB @ CoC, height: 13cm, 010425B
ALI10.cfg	01-04-25\13_19_54.CCD	
offx_n1.CFG	01-04-25\13_27_21.CCD	
Configuration File	CCD File	Position Picture
		Position 2: Normal IB @ CoC, height: 13cm, 010425C
offx_n1.CFG	01-04-25\13_32_01.CCD	

R O S E T T A		Document: RO-IGM-TR-0002
		Issue: 2
		Revision: 2
IGM	Institut für Geophysik und Meteorologie Technische Universität Braunschweig	Date: October 10, 2001
		Page: 122

Configuration File	CCD File	Position Picture
		Position 3: Turned @ \Zc OB @ CoC, height: 13cm, 010425D
ALI10.cfg	01-04-25\13_38_17.CCD	
offx_t1.CFG	01-04-25\13_45_28.CCD	

Configuration File	CCD File	Position Picture
		Position 4: Turned @ \Zc IB @ CoC, height: 13cm, 010425E
offx_t1.CFG	01-04-25\13_53_02.CCD	

Configuration File	CCD File	Position Picture
		Position 5: Turned @ \Yc OB @ CoC, height: 20cm, 010425F
ALI10.cfg	01-04-25\14_01_34.CCD	
offz_t1.CFG	01-04-25\14_08_44.CCD	

Configuration File	CCD File	Position Picture
		Position 6: Turned @ \Yc IB @ CoC, height: 20cm, 010425G
offz_t1.CFG	01-04-25\14_15_35.CCD	

After the successful executed offset measurement of the FS sensor with the FS DPU we changed the setup to repeat the failed frequency measurements.

20.4 Digital Frequency Response — DPU: FS, Sensors FS-IB & FS-OB, Repetition

The digital frequency response function which was measured in this morning will be repeated now, as the 50 Ω terminator was not connected at the Y_C -input channel at the morning measurement.

Frequency measurement setup as usual. The sensors have been mounted on the gradiometer sensor plate, as on April, 20th. Refer to picture 263.

R O S E T T A		Document: RO-IGM-TR-0002
		Issue: 2
		Revision: 2
IGM	Institut für Geophysik und Meteorologie Technische Universität Braunschweig	Date: October 10, 2001
		Page: 123

Purpose: Measure the digital frequency response

Conditions: FS-IB & FS-OB placed diagonal in space in the coil system center.
FS-OB is the upper, FS-IB the lower one.
AC-Generator signal (AC2) applied to Y_c without attenuator.

MAD: Ch0 to Ch2 connected to Zopfmag x to z, 10 nT/mV;
Ch6 Generator signal (AC2) direct (no attenuation);
Ch7 FSP pulse;
Timer 500, SumUp 6, Vector Rate 16.67 Hz.

Files: F_LONG.SEQ

Start: 25.04.01 14:38

End: 26.04.01 03:28

20.4.1 Data

Configuration File	CCD File
ALI10.cfg	01-04-25\14_38_48.CCD
fd_h.CFG	01-04-25\14_46_10.CCD
fd_l.CFG	01-04-25\15_33_33.CCD
fd_h.CFG	01-04-25\16_20_57.CCD
fd_l.CFG	01-04-25\17_08_17.CCD
fd_h.CFG	01-04-25\17_55_38.CCD
fd_l.CFG	01-04-25\18_42_58.CCD
fd_h.CFG	01-04-25\19_30_18.CCD
fd_l.CFG	01-04-25\20_17_39.CCD
fd_h.CFG	01-04-25\21_04_59.CCD
fd_l.CFG	01-04-25\21_52_20.CCD
fd_h.CFG	01-04-25\22_39_41.CCD
fd_l.CFG	01-04-25\23_27_01.CCD

20.5 Overview Plots: System Performance, Temperatures and Earth-field Variations.

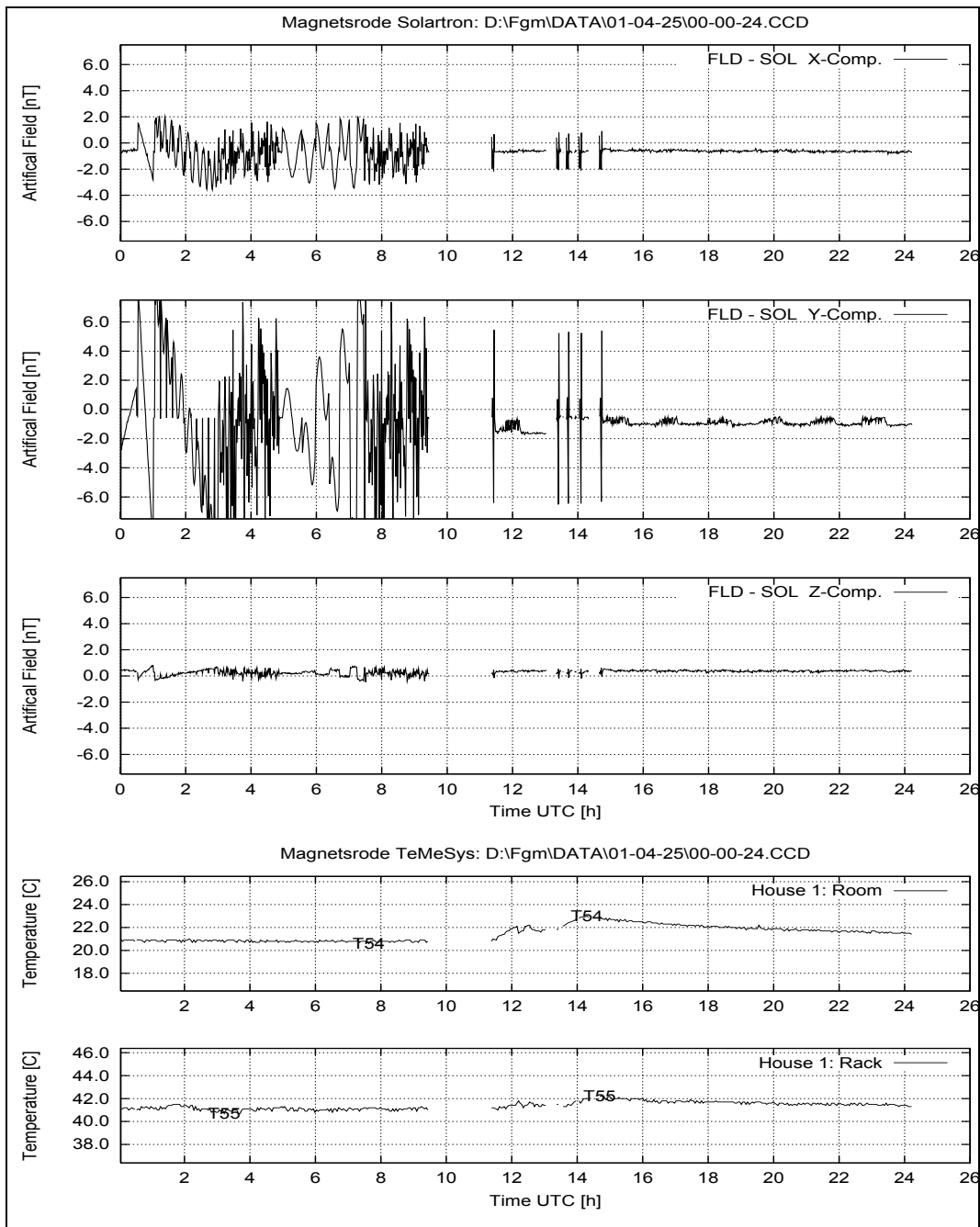

Figure 78: April 25, 2001: System Performance: FLD – SOL; Temperatures at House 1.

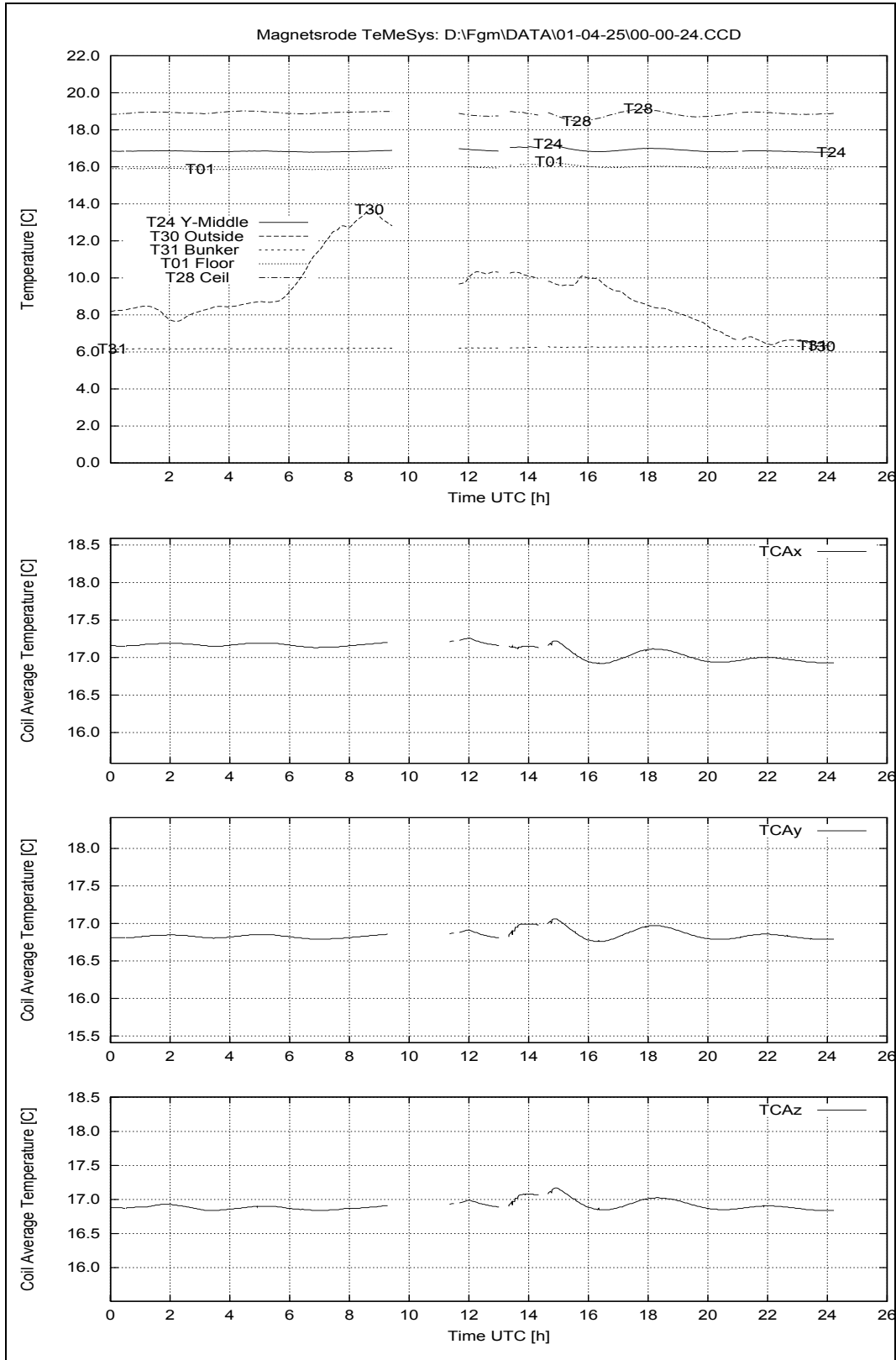

Figure 79: April 25, 2001: Temperatures House 2.

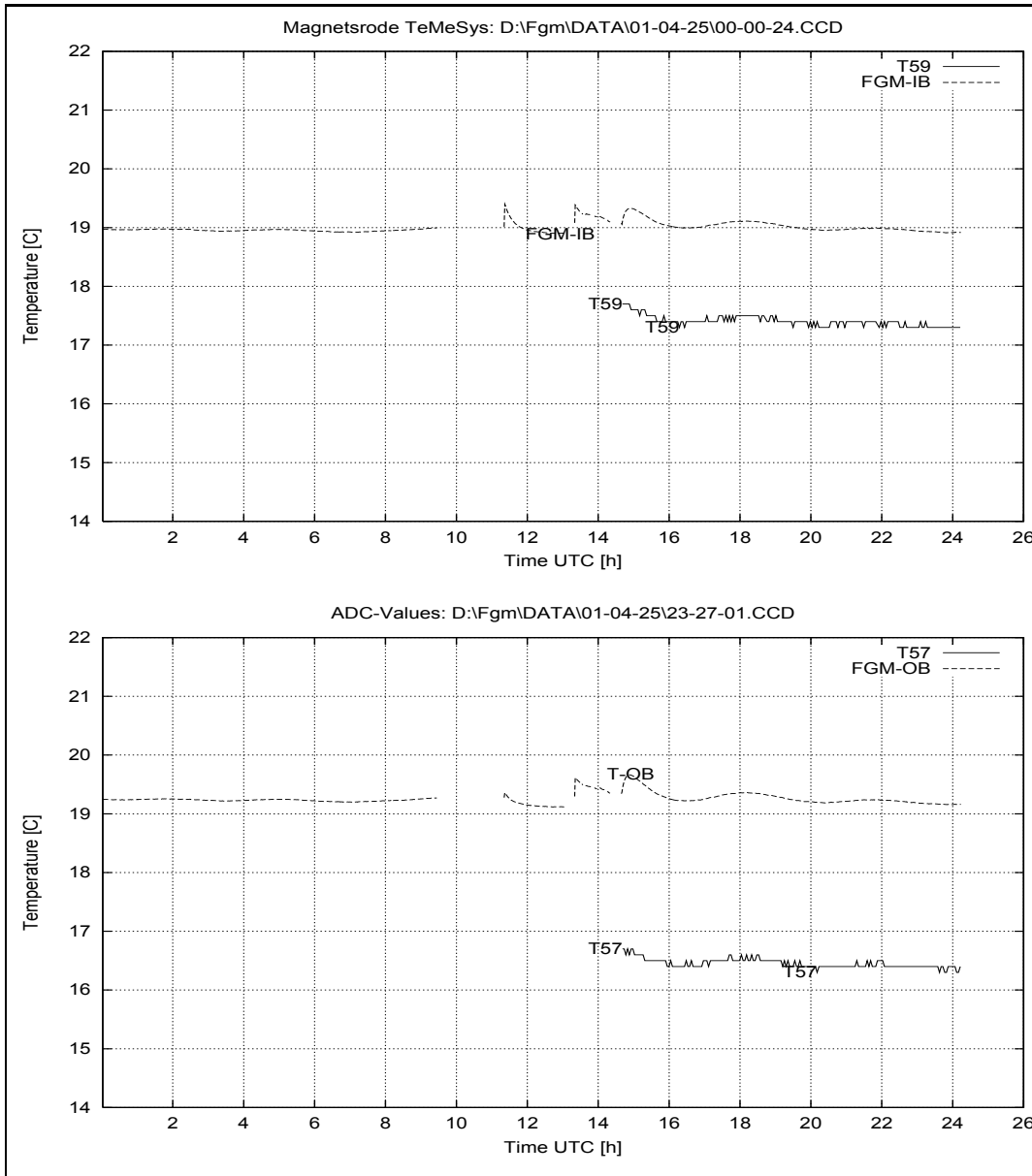

Figure 80: April 25, 2001: Sensor Temperatures at House 2.

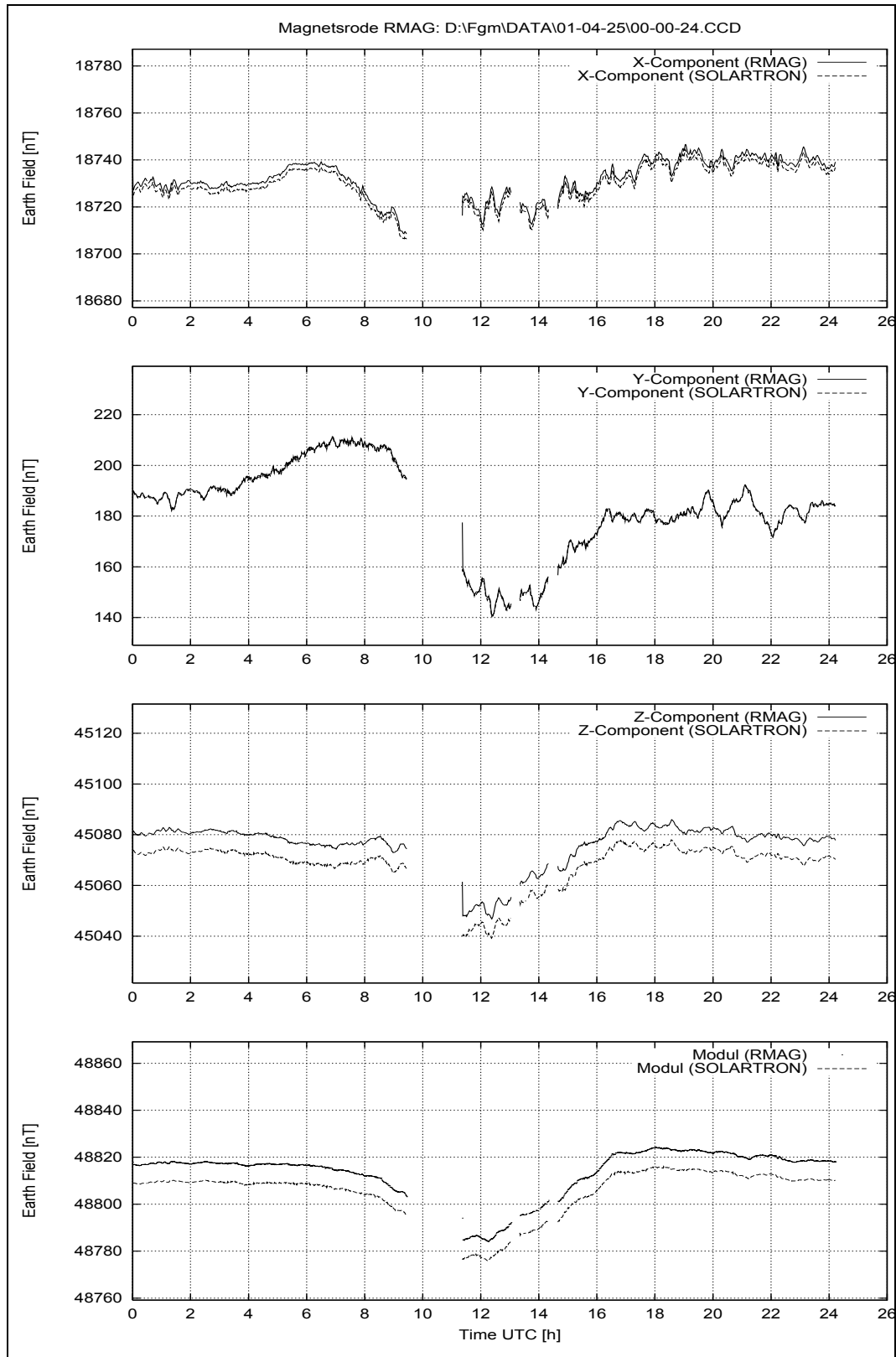

Figure 81: April 25, 2001: Earthfield variations.

21 Thursday April 26, 2001

21.1 Digital Frequency Response — DPU: FS, Sensors FS-IB & FS-OB, Repetition

As there was a lot of time during the night we repeated the frequency measurements for some times. The sequence ended at 03:38.

21.1.1 Data

Configuration File	CCD File
fd_h.CFG	01-04-26\00_14_21.CCD
fd_l.CFG	01-04-26\01_01_41.CCD
fd_h.CFG	01-04-26\01_49_02.CCD
fd_l.CFG	01-04-26\02_36_22.CCD

Afterwards the setup for the voltage variation check was prepared.

21.2 Supply Voltage Dependence — DPU: FS, Sensors FS-IB & FS-OB

With this check it should be tested whether the digital readings are influenced by the supply voltage. Therefore, the supply voltages generated by the instrument power supply are varied in discrete steps. The needed positive and negative supply voltages are changed in parallel at the same time.

The used voltages are:

Step	Voltage [V]	%-Variation
1	±5.00	abs(Nominal)
2	±4.90	abs(Nominal) -2%
3	±4.75	abs(Nominal) -5%
4	±4.50	abs(Nominal) -10%
5	±5.10	abs(Nominal) +2%
6	±5.25	abs(Nominal) +5%
7	±5.50	abs(Nominal) +10%

The test is done for both, FS-OB and FS-IB, sensors. The sensors are placed in diagonal in space position. Unchanged since the recent frequency measurements. Refer to picture 263.

R O S E T T A		Document: RO-IGM-TR-0002
IGM Institut für Geophysik und Meteorologie Technische Universität Braunschweig		Issue: 2
		Revision: 2
		Date: October 10, 2001
		Page: 129

Purpose: Measure supply voltage dependence of the digital data readings.
Conditions: FS-IB & FS-OB placed diagonal in space in the coil system center.
FS-OB is the upper, FS-IB the lower one
MAD: Ch0 to Ch2 connected to Zopfinag x to z, 10 nT/mV;
Ch7 FSP pulse;
Timer 500, SumUp 100, Vector Rate 1.00 Hz.
Files: PWR_VAR.*
Start: 26.04.01 08:34:20
End: 26.04.01 09:11

21.2.1 Data

Configuration File	CCD File
	ADC1
pwr_var.cfg	01-04-26\08_34_20.CCD
pwr_var.cfg	01-04-26\08_40_18.CCD
pwr_var.cfg	01-04-26\08_45_39.CCD
pwr_var.cfg	01-04-26\08_50_44.CCD
pwr_var.cfg	01-04-26\08_56_21.CCD
pwr_var.cfg	01-04-26\09_01_17.CCD
pwr_var.cfg	01-04-26\09_06_31.CCD

21.2.2 Results

The following plots show the results of the supply voltage variation check. As visible in the first diagram of figure 82 and 83 the applied field structure was 0 nT, +20000 nT, -20000 nT, 0 nT for every pair of supply voltages. For a better visibility the y -component has been plotted with an inverted sign. Additionally the single traces have been shifted by convenient offsets for a maximum of clarity.

The analysis of the plots reveals that the FS-OB- y and the FS-OB- z component are nearly constant. The other ones, however, show significant changes in dependency of the supply voltage in the region of positive deviation of the nominal supply voltage. Figure 84 shows the result in the most clear way, as the output signals of both, the FS-OB and the FS-IB sensors, are plotted versus the deviation of the supply voltage.

As the power supply onboard the ROSETTA s/c will keep the voltages constant in the order of 1 %, the performance of the instrument is acceptable.

After these special power supply variation check the setup was changed for the temperature measurements of the FS Sensors connected to the FS DPU.

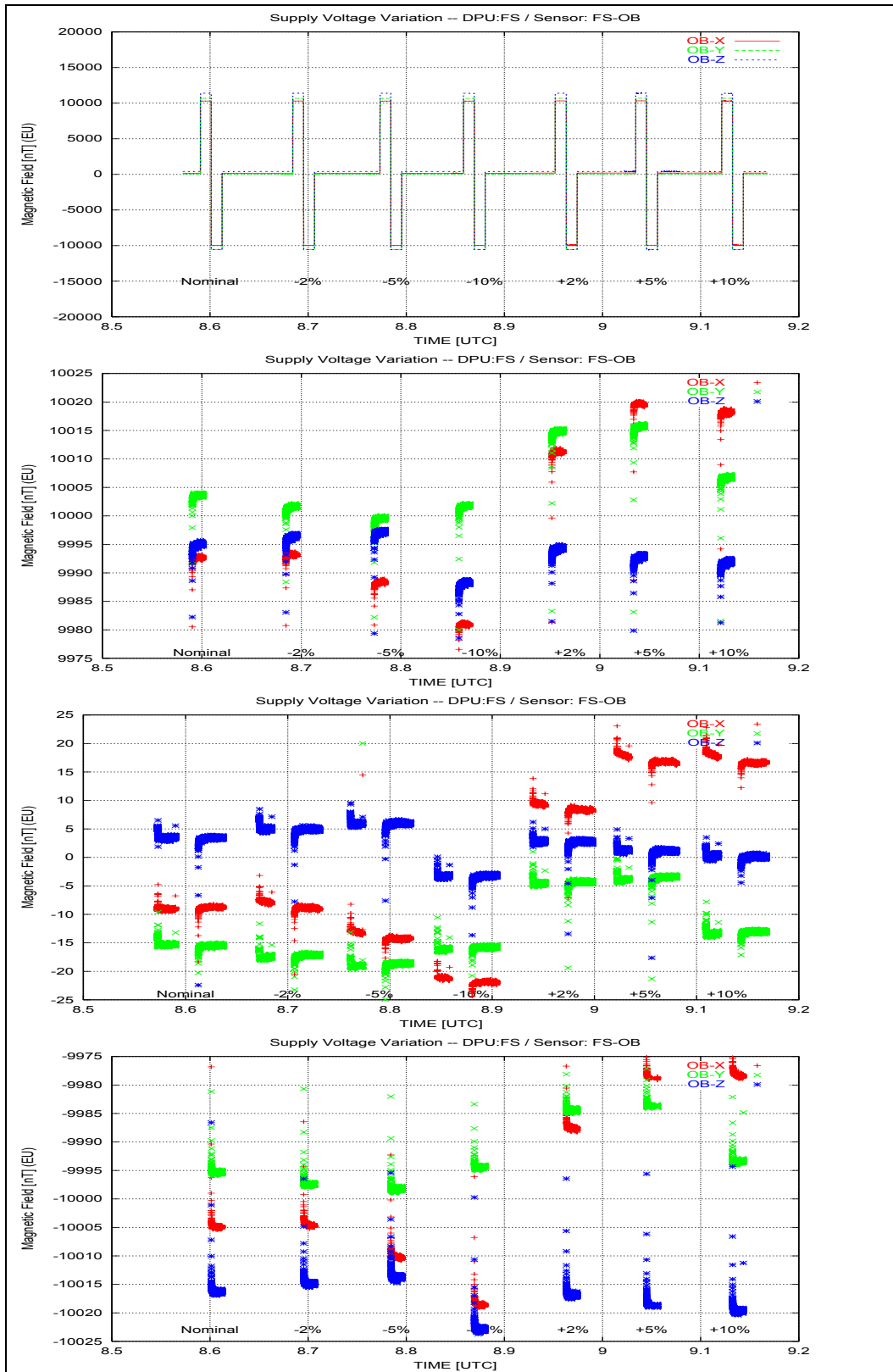

Figure 82: Supply voltage dependence results: FS – OB.

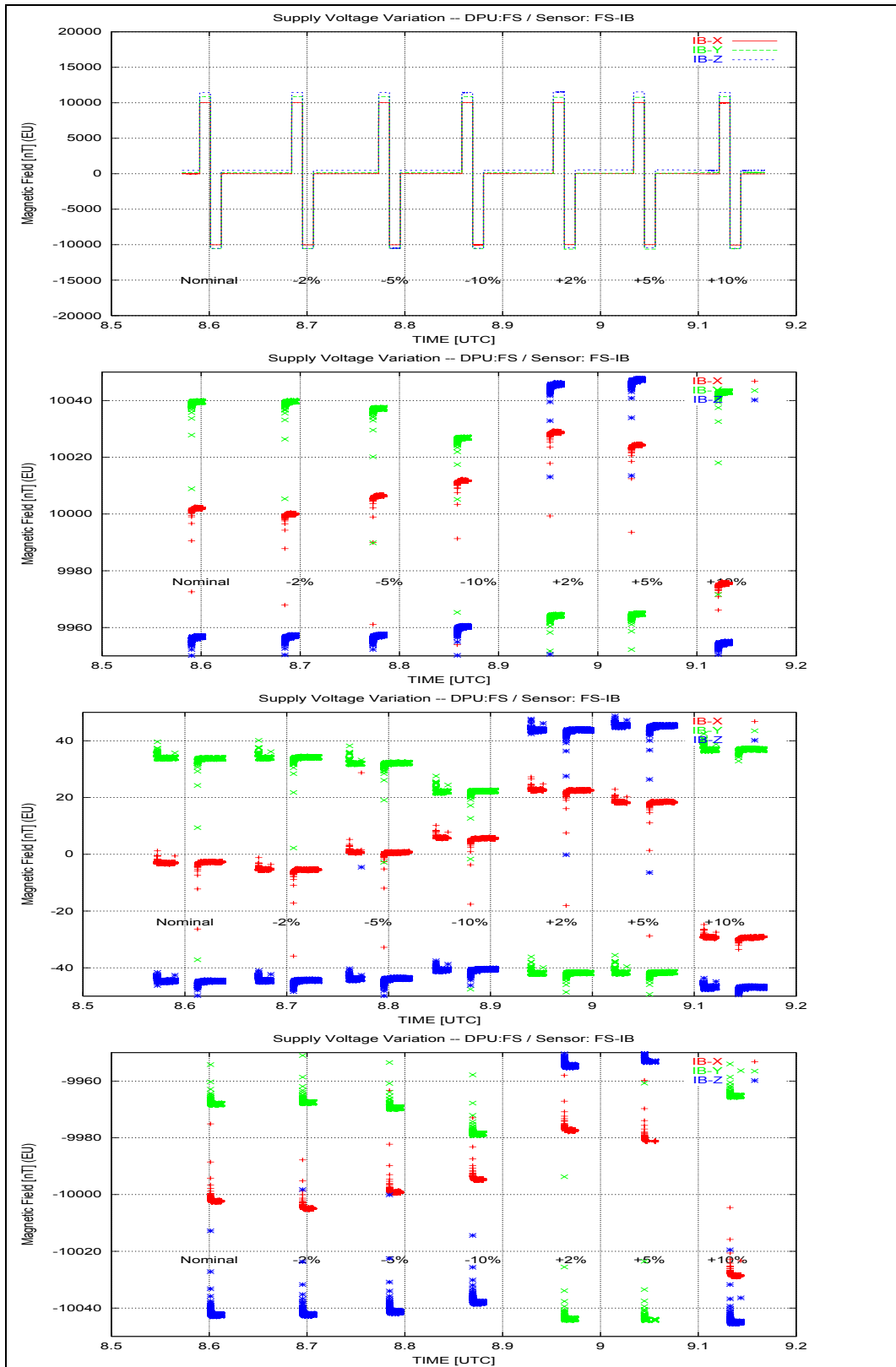

Figure 83: Supply voltage dependence results: FS – IB.

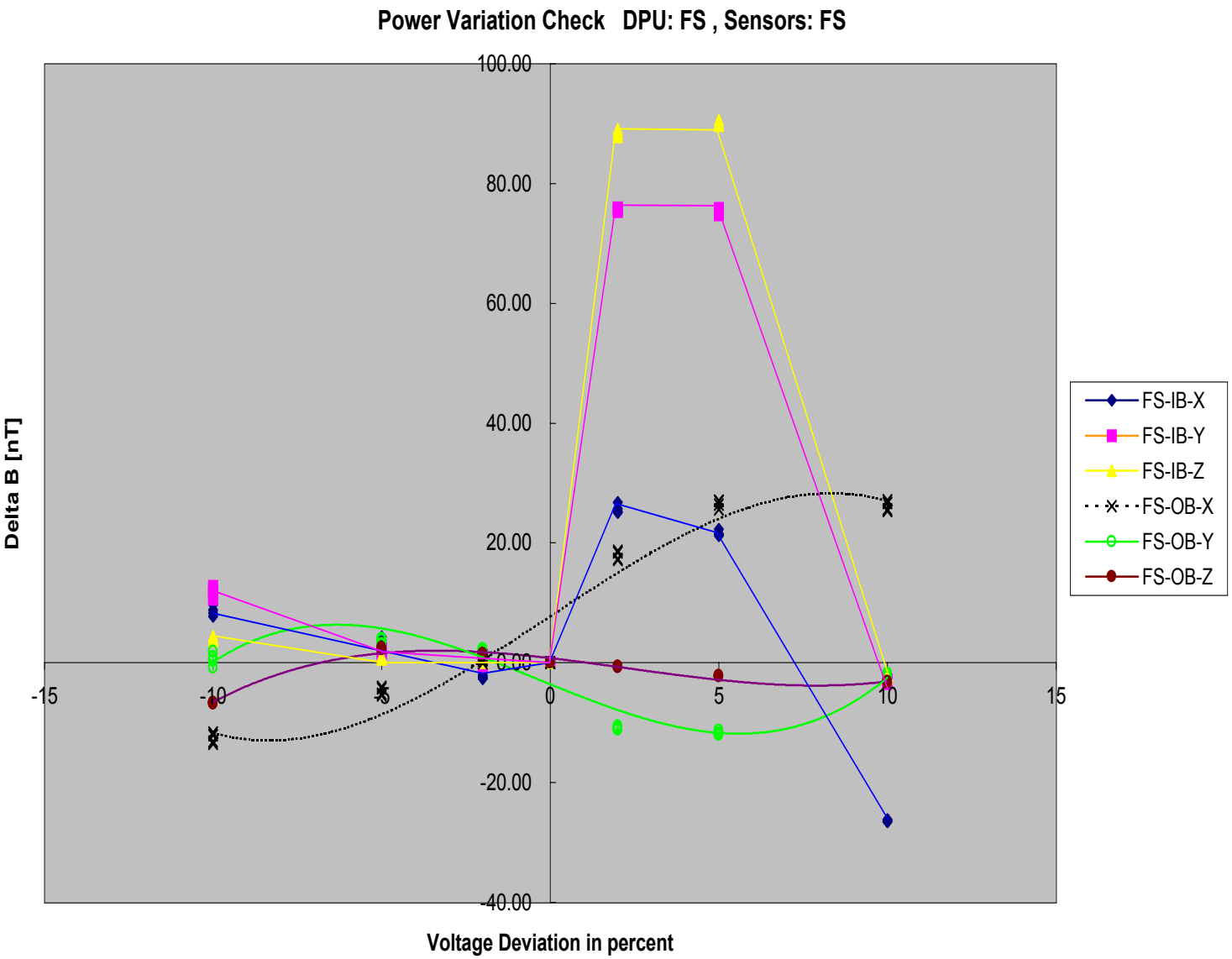

Figure 84: Supply voltage dependence results: DPU: FS, Sensors: FS.

21.3 Setup for the Temperature Calibration

Both sensors, mounted together on their aluminium support, are fixed on the mounting plate of the Thermal Test Box. See figure 85 for details. Also a photographic view (figures 264 and 265) will help.

The FS-OB is on the northern side, FS-IB on the southern side. The temperature sensors of the TEMESYS-B system T₅₆ to T₆₃ are placed in the box. The positions are given in table 4.

Sensor	Position
T ₅₇	under FS-OB sensor
T ₅₉	under FS-IB sensor
T ₅₆	mounting plate, upper side, western edge, central
T ₅₈	mounting plate, upper side, south west corner
T ₂₉	outside thermal box at the northern side of the Coil System
T ₆₀	ground plate, north middle
T ₆₁	mounting plate, eastern side, central
T ₆₂	ground plate, south west
T ₆₃	ground plate, south east

Table 4: The TEMESYS-B sensors in the Thermal Test Box.

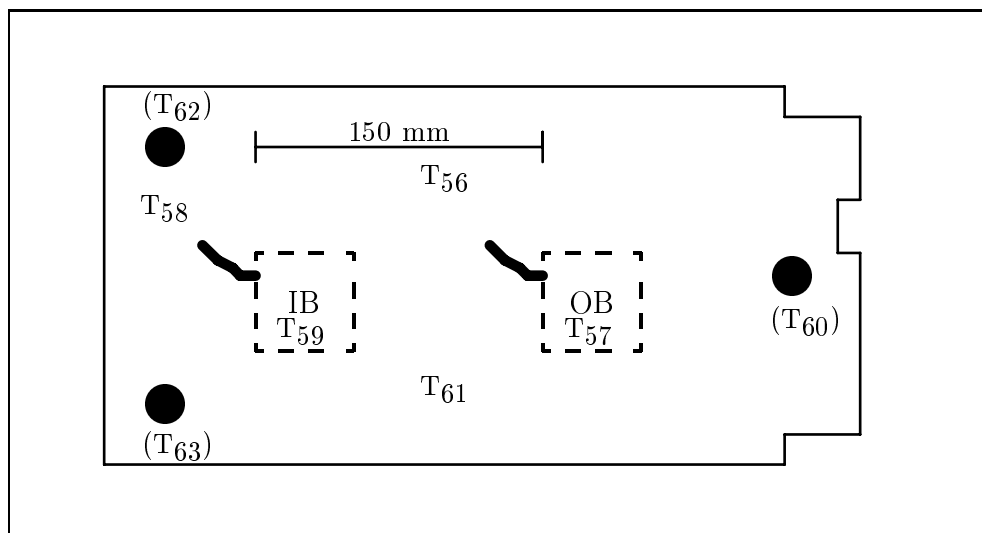

Figure 85: The temperature sensors at the Thermal Test Box mounting plate. The draft shows the top view. Sensors in brackets are mounted near the Thermal Test Box ground plate, not on the mounting plate.

The software TEMPCTRL is used to control the heating process. This software switches on the electrical heater during the SOLARTRON measurement cycle. This was done, because during the SOLARTRON measurements the data should not be used and so they may be disturbed anyway. For details on the heater and the control software see the

R O S E T T A		Document: RO-IGM-TR-0002
		Issue: 2
		Revision: 2
IGM	Institut für Geophysik und Meteorologie Technische Universität Braunschweig	Date: October 10, 2001
		Page: 134

related document *MR-IGM-TN0005*. The appendix E gives details on the measurements and shows an overview on the complete cooling and heating cycle.

21.4 Temperature Cycle, Linearities, FS Sensors

Before the temperature calibration will be performed some linearity measurements should be executed in the chosen setup for the temperature cycle. The sensors are fixed, but the box is still open for filling in the dry ice after these measurements.

Purpose: Measure the linearity of the FGM-FS sensors.
Conditions: FS-OB and FS-IB placed in the Thermal Test Box on the aluminium support. The distance between them is 150 mm.
MAD: Ch0 to Ch2 connected to Zopfmag x to z, 10 nT/mV;
Ch7 FSP;
Timer 500, SumUp 100, Vectorrate 1.00 Hz.
Files: T_LIN.SEQ
Start: 26.04.01 09:57
End: 26.04.01 10:45

21.4.1 Data

Configuration File	CCD File
ali10.CFG	01-04-26\09_57_42.CCD
TX15.CFG	01-04-26\10_05_09.CCD
TY15.CFG	01-04-26\10_18_10.CCD
TZ15.CFG	01-04-26\10_31_11.CCD

R O S E T T A		Document: RO-IGM-TR-0002
		Issue: 2
		Revision: 2
IGM	Institut für Geophysik und Meteorologie Technische Universität Braunschweig	Date: October 10, 2001
		Page: 135

21.5 Temperature Calibration, Cooling Cycle, FS Sensors

Purpose: Measure the temperature behaviour of the FS sensors.

Conditions: FS-OB and FS-IB placed in the Thermal Test Box on the aluminium support. The distance between them is 150 mm.
OB north and IB south of CoC.

MAD: Ch0 to Ch2 connected to Zopfmag x to z, 10 nT/mV;
Ch7 FSP;
Timer 500, SumUp 100, Vectorrate 1.00 Hz.

Files: TEMP2.SEQ

REMARK Sequence contains T_LIN.SEQ after T-Cycle

Temperature

File: ROSETTA2.CUR (SOL-Time = 24 s, FLD-Time = 40 s)

Start: 26.04.01 10:53

End: 02.05.01 17:00 ESC.

Remark: 10 kg of broken dry ice are filled in during the first measurement.
Dry ice fill in between 10:59 and 11:04.

21.5.1 Data

Configuration File	CCD File	Remark
14000XYZ.CFG	01-04-26\10_53_36.CCD	Dry Ice filled in
ali10.CFG	01-04-26\11_26_34.CCD	
TEMP.CFG	01-04-26\11_33_50.CCD	
TEMP.CFG	01-04-26\12_41_30.CCD	
TEMP.CFG	01-04-26\13_49_11.CCD	
TEMP.CFG	01-04-26\14_56_51.CCD	
TEMP.CFG	01-04-26\16_04_32.CCD	
TEMP.CFG	01-04-26\17_12_14.CCD	
TEMP.CFG	01-04-26\18_19_55.CCD	
TEMP.CFG	01-04-26\19_27_56.CCD	
TEMP.CFG	01-04-26\20_35_37.CCD	
TEMP.CFG	01-04-26\21_43_18.CCD	
TEMP.CFG	01-04-26\22_50_58.CCD	
TEMP.CFG	01-04-26\23_58_38.CCD	

21.6 Overview Plots: System Performance, Temperatures and Earth-field Variations.

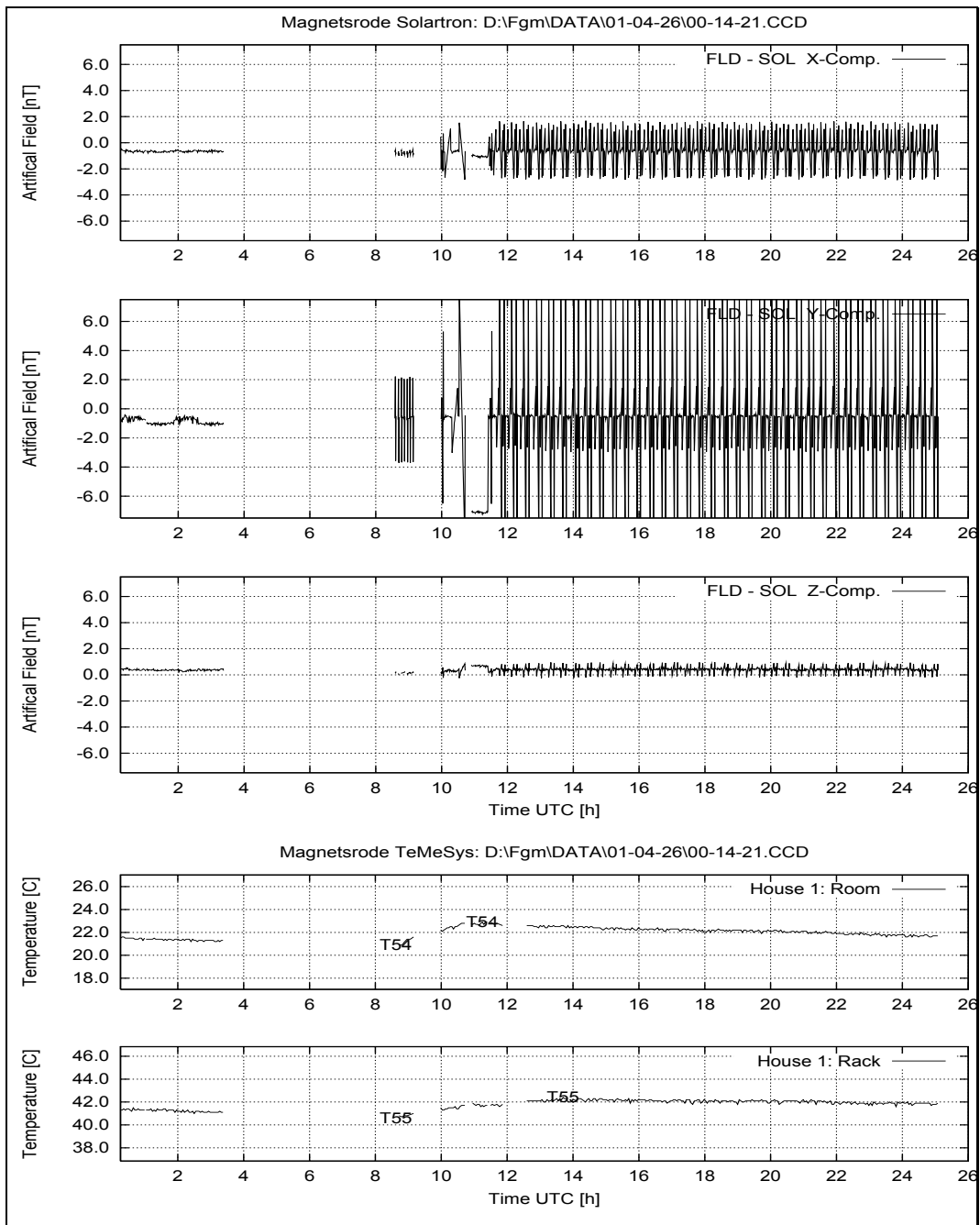

Figure 86: April 26, 2001: System Performance: FLD – SOL; Temperatures at House 1.

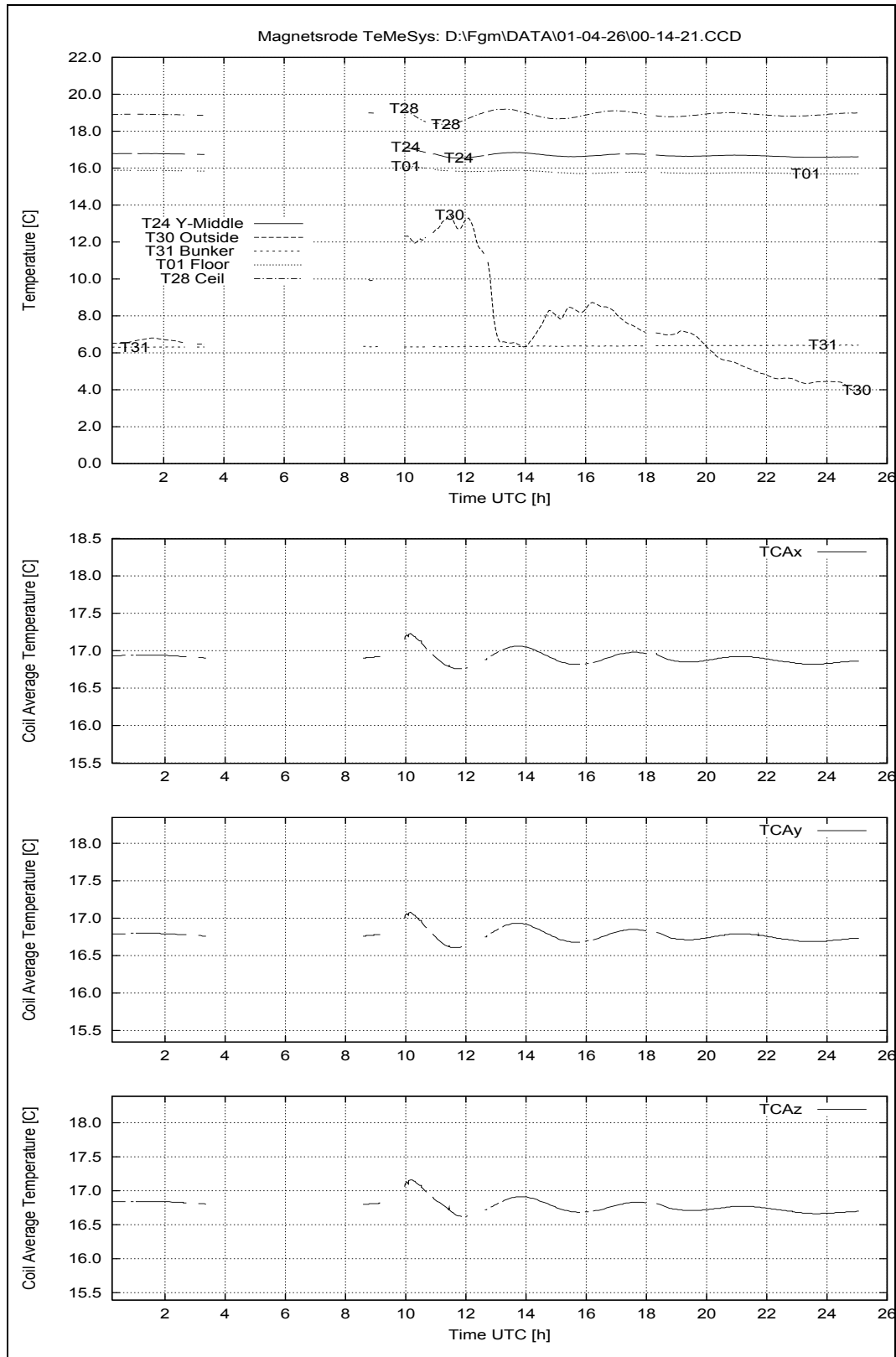

Figure 87: April 26, 2001: Temperatures House 2.

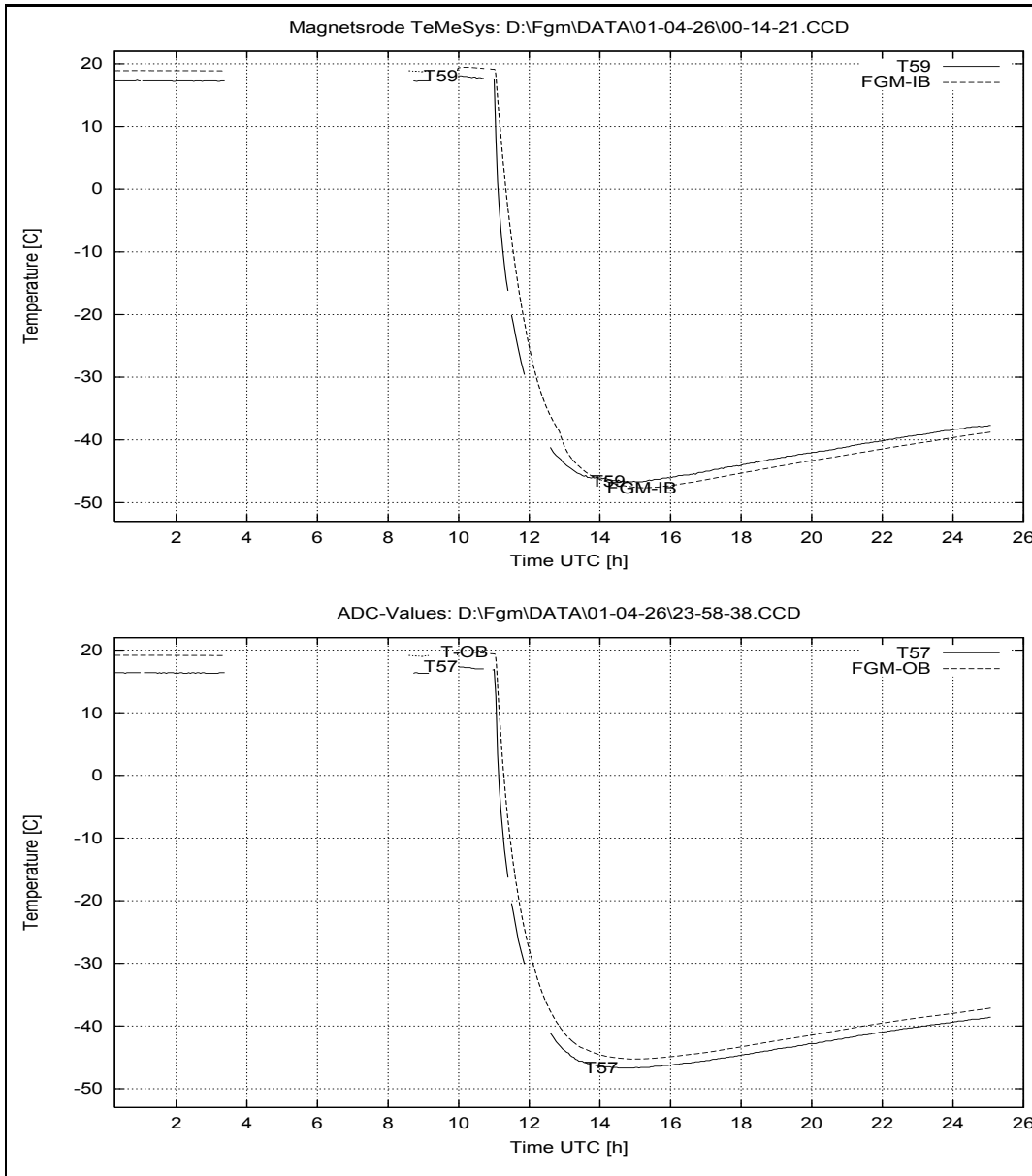

Figure 88: April 26, 2001: Sensor Temperatures at House 2.

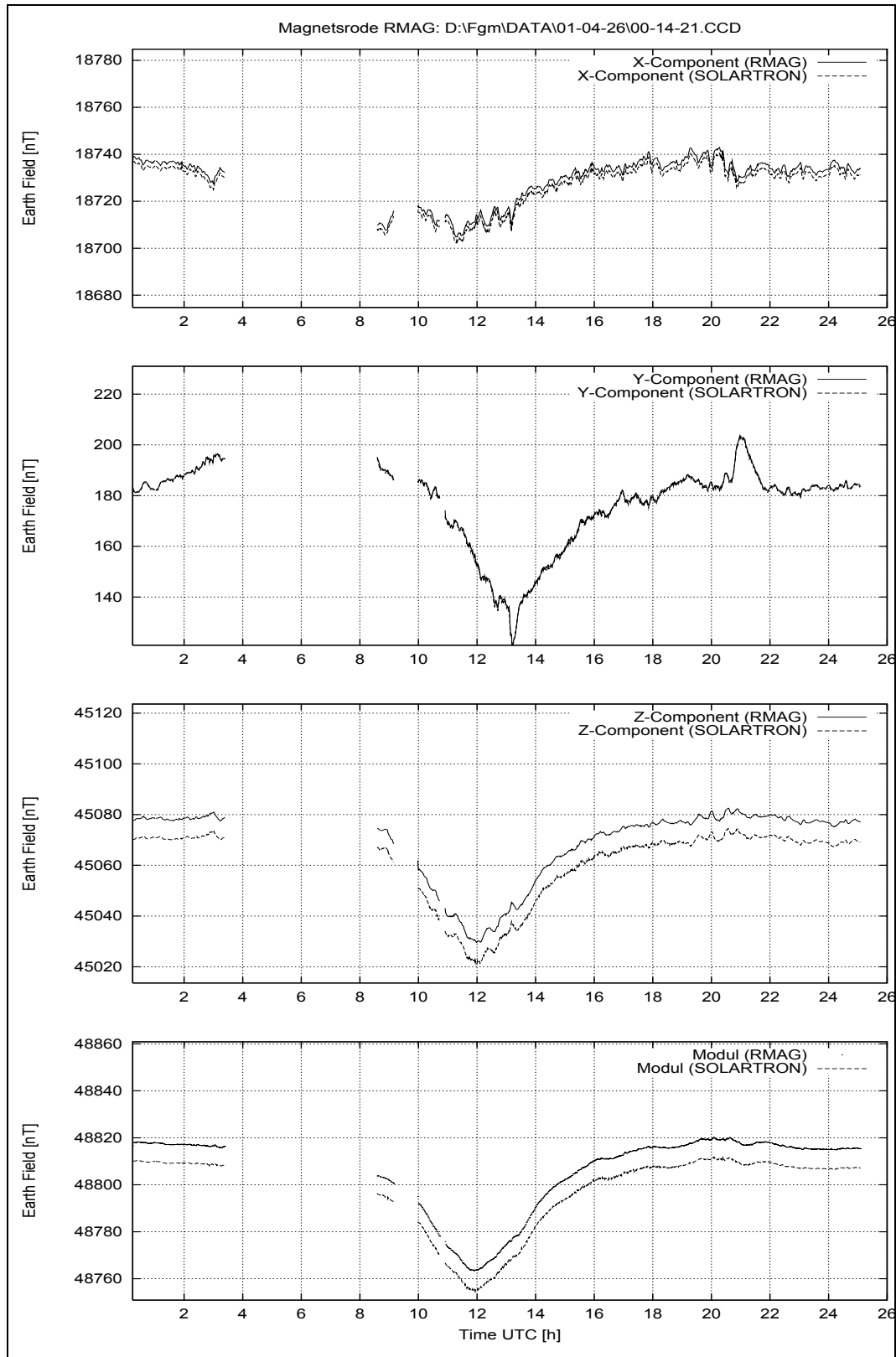

Figure 89: April 26, 2001: Earthfield variations.

R O S E T T A		Document: RO-IGM-TR-0002
		Issue: 2
		Revision: 2
IGM	Institut für Geophysik und Meteorologie	Date: October 10, 2001
	Technische Universität Braunschweig	Page: 140

22 Friday April 27, 2001

22.1 Temperature Calibration, Cooling Cycle, FS Sensors, Continued

The cooling cycle goes on today without any problem. No personnel around today.

22.1.1 Data

Configuration File	CCD File	CCD File	Remark
TEMP.CFG	01-04-27\01_06_18.CCD	01-04-27\13_30_44.CCD	
TEMP.CFG	01-04-27\02_13_58.CCD	01-04-27\14_38_26.CCD	
TEMP.CFG	01-04-27\03_21_38.CCD	01-04-27\15_46_21.CCD	
TEMP.CFG	01-04-27\04_29_18.CCD	01-04-27\16_54_02.CCD	
TEMP.CFG	01-04-27\05_36_57.CCD	01-04-27\18_01_43.CCD	
TEMP.CFG	01-04-27\06_44_38.CCD	01-04-27\19_09_24.CCD	
TEMP.CFG	01-04-27\07_52_19.CCD	01-04-27\20_17_05.CCD	
TEMP.CFG	01-04-27\09_00_03.CCD	01-04-27\21_24_46.CCD	
TEMP.CFG	01-04-27\10_07_43.CCD	01-04-27\22_32_27.CCD	
TEMP.CFG	01-04-27\11_15_23.CCD	01-04-27\23_40_08.CCD	
TEMP.CFG	01-04-27\12_23_04.CCD		

22.2 Overview Plots: System Performance, Temperatures and Earth-field Variations.

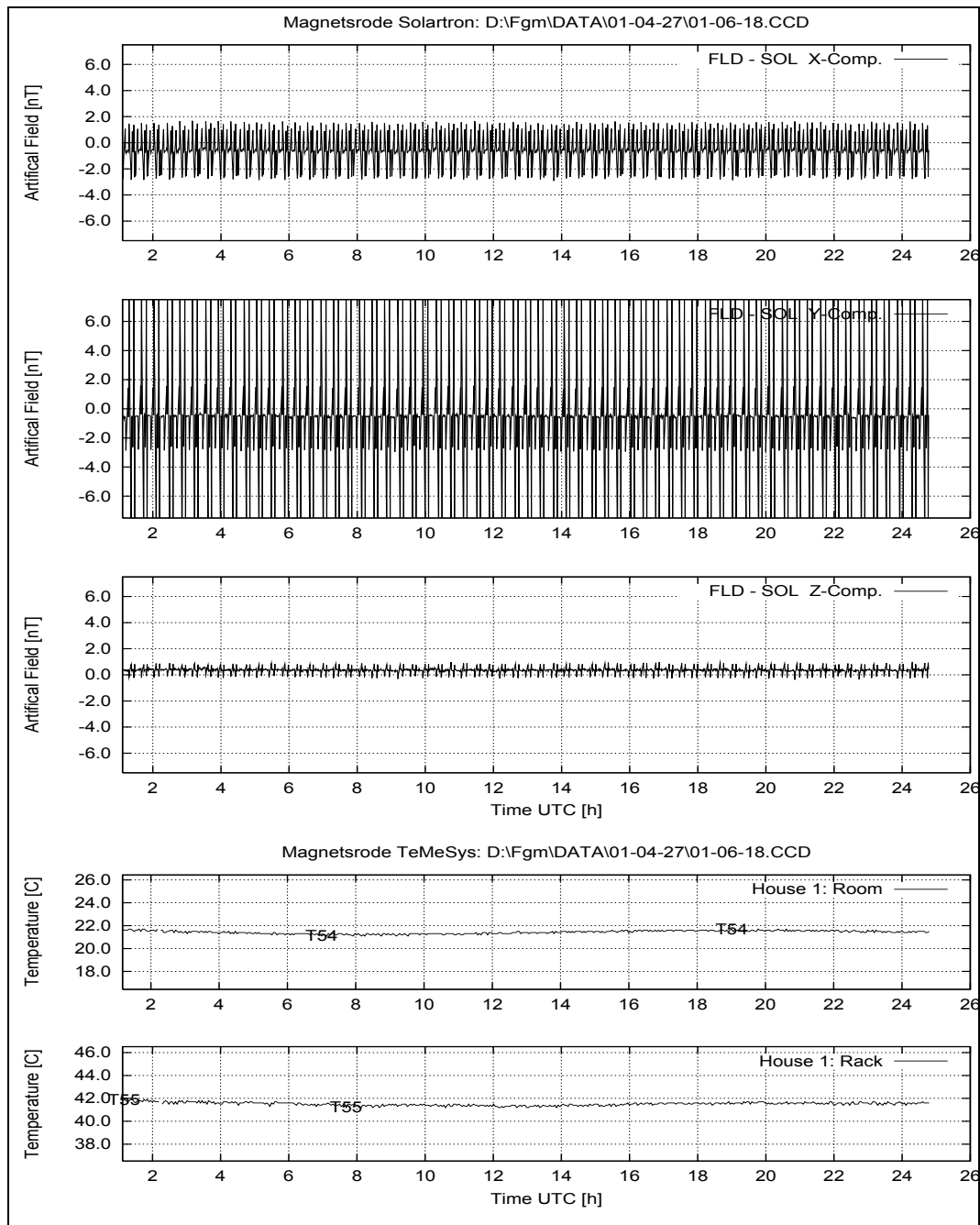

Figure 90: April 27, 2001: System Performance: FLD – SOL; Temperatures at House 1.

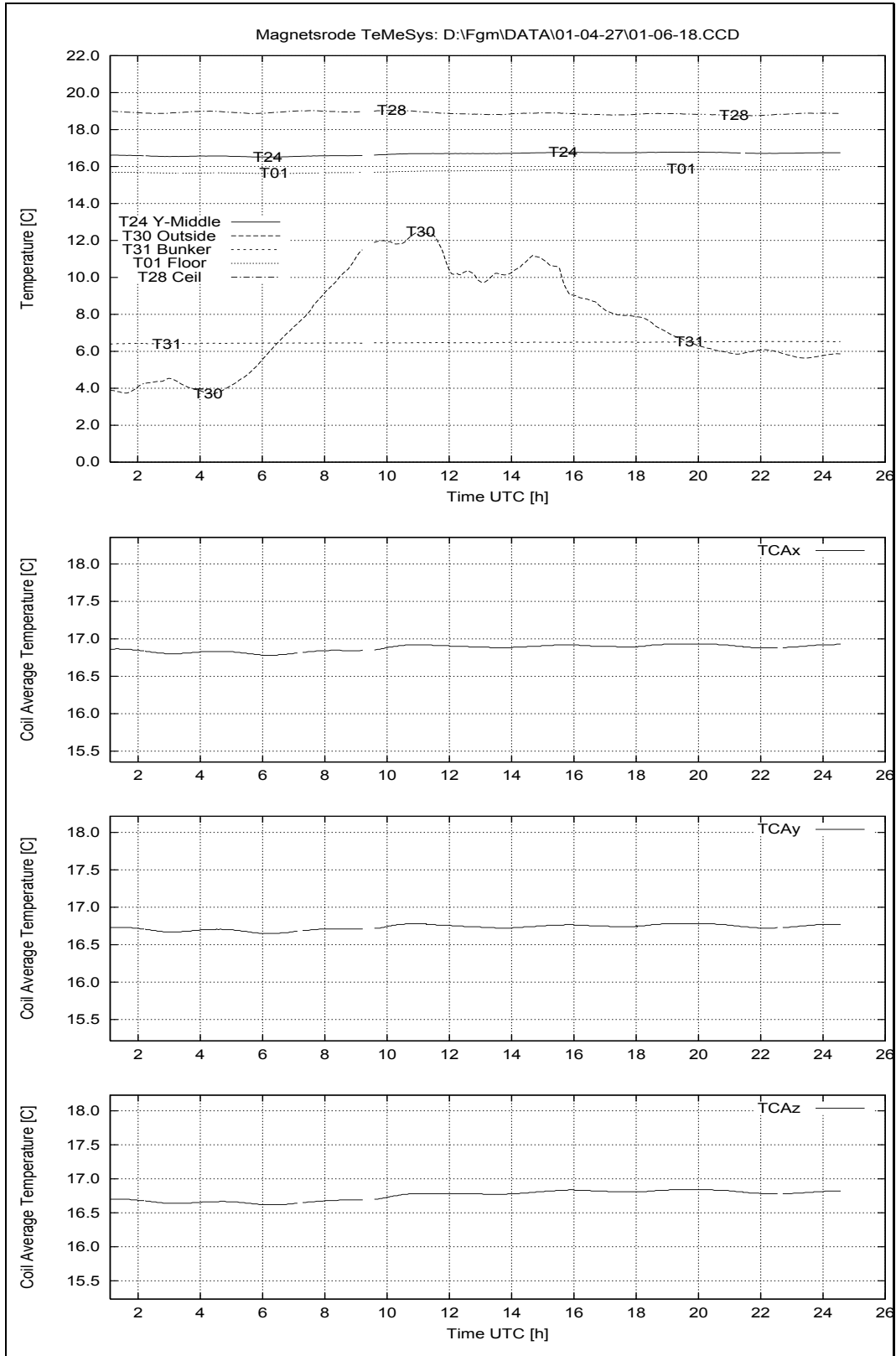

Figure 91: April 27, 2001: Temperatures House 2.

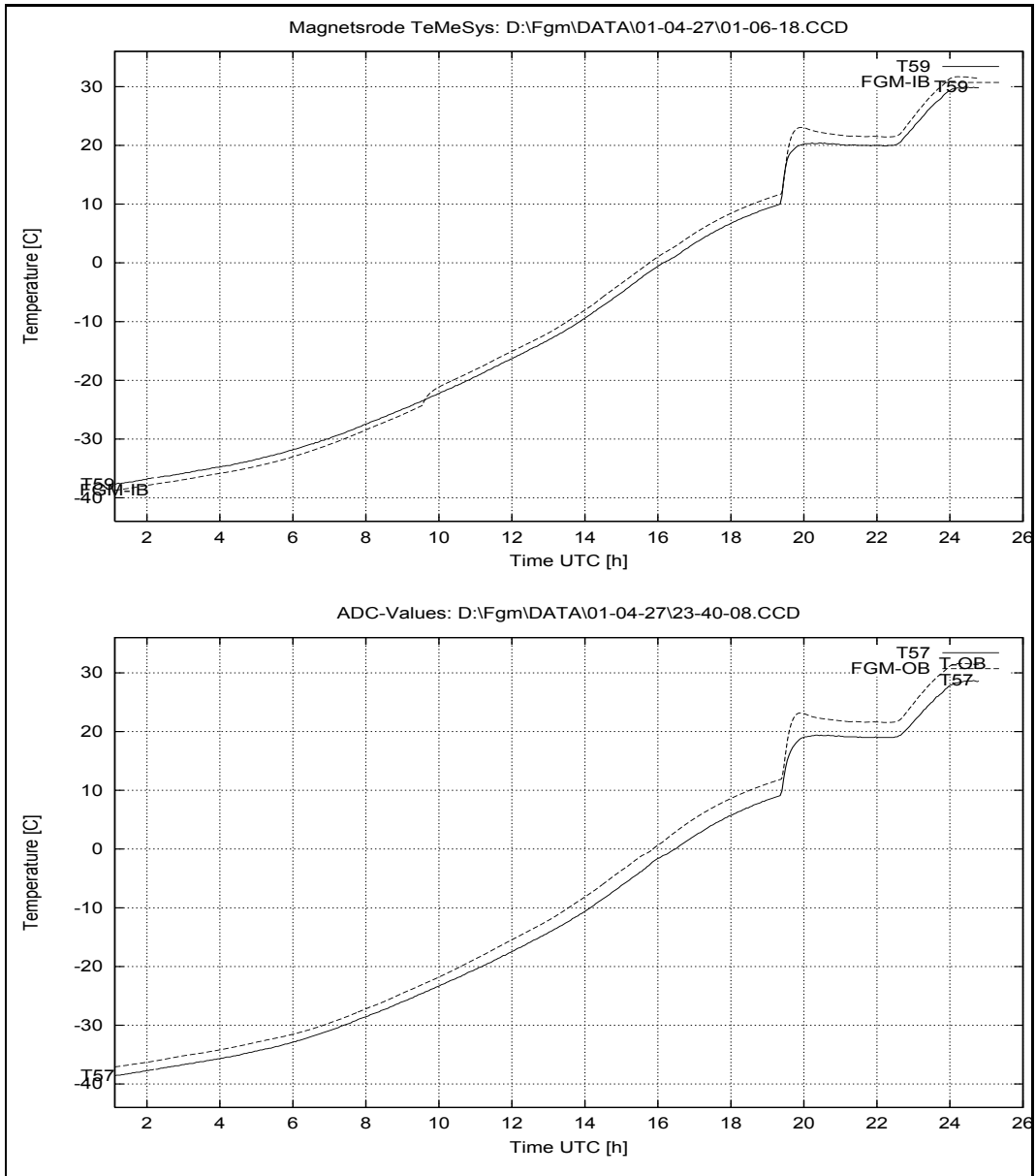

Figure 92: April 27, 2001: Sensor Temperatures at House 2.

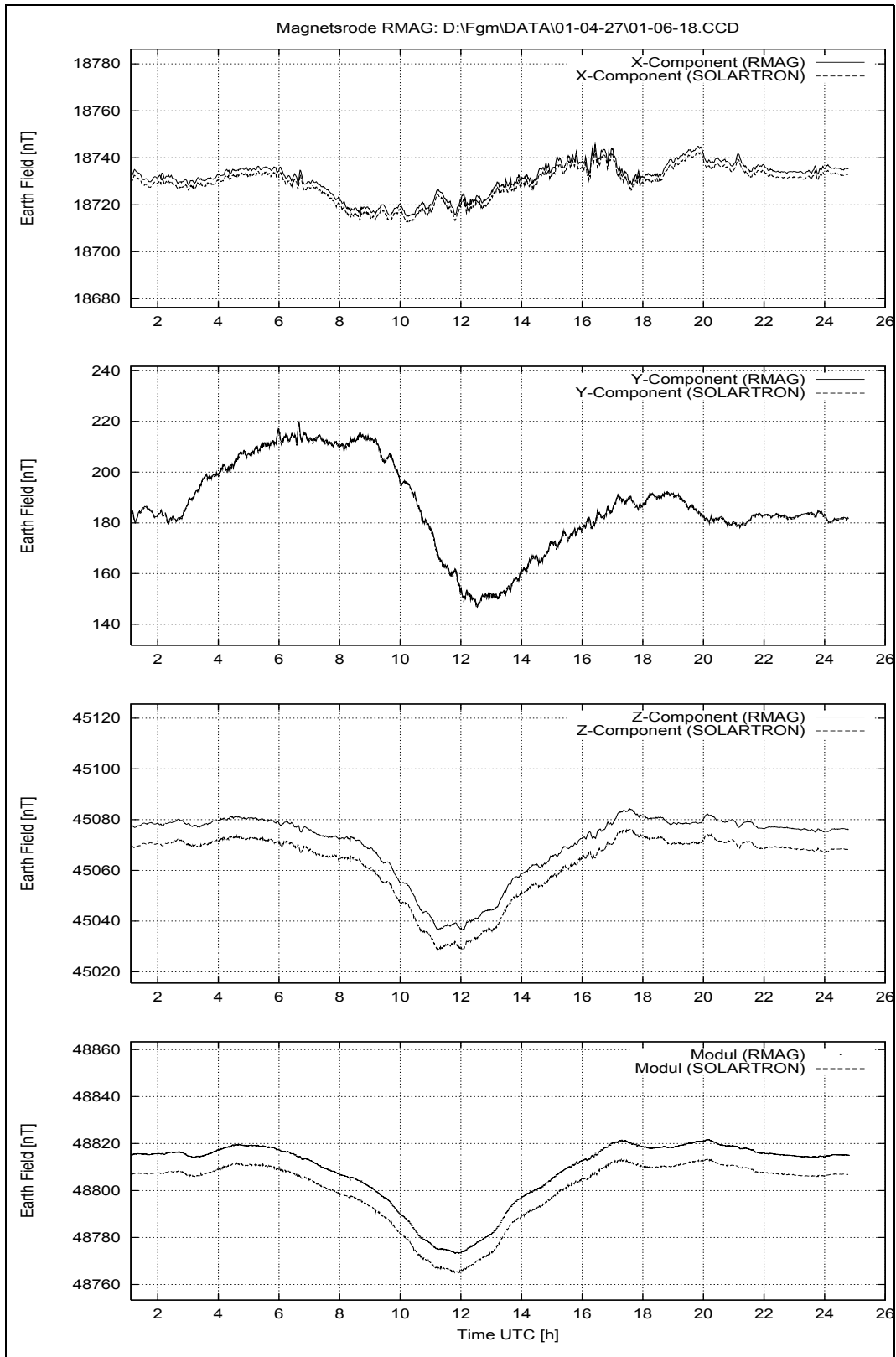

Figure 93: April 27, 2001: Earthfield variations.

R O S E T T A		Document: RO-IGM-TR-0002
IGM Institut für Geophysik und Meteorologie Technische Universität Braunschweig		Issue: 2
		Revision: 2
		Date: October 10, 2001
		Page: 145

23 Saturday April 28, 2001

23.1 Temperature Calibration, Heating Cycle, FS Sensors

The cooling cycle ended yesterday evening. At reaching +10° the heating cycle started automatically as TEMPCTRL was in AUTOMATIC running mode. The processed temperature profile was ROSSETTA2.CUR

No personnel around today.

23.1.1 Data

Configuration File	CCD File	CCD File	Remark
TEMP.CFG	01-04-28\00_47_48.CCD	01-04-28\13_13_15.CCD	
TEMP.CFG	01-04-28\01_55_28.CCD	01-04-28\14_20_56.CCD	
TEMP.CFG	01-04-28\03_03_08.CCD	01-04-28\15_29_04.CCD	
TEMP.CFG	01-04-28\04_10_49.CCD	01-04-28\16_36_43.CCD	
TEMP.CFG	01-04-28\05_19_21.CCD	01-04-28\17_44_24.CCD	
TEMP.CFG	01-04-28\06_27_01.CCD	01-04-28\18_52_04.CCD	
TEMP.CFG	01-04-28\07_34_41.CCD	01-04-28\19_59_45.CCD	
TEMP.CFG	01-04-28\08_42_21.CCD	01-04-28\21_07_24.CCD	
TEMP.CFG	01-04-28\09_50_02.CCD	01-04-28\22_15_05.CCD	
TEMP.CFG	01-04-28\10_57_42.CCD	01-04-28\23_22_46.CCD	
TEMP.CFG	01-04-28\12_05_35.CCD		

23.2 Overview Plots: System Performance, Temperatures and Earth-field Variations.

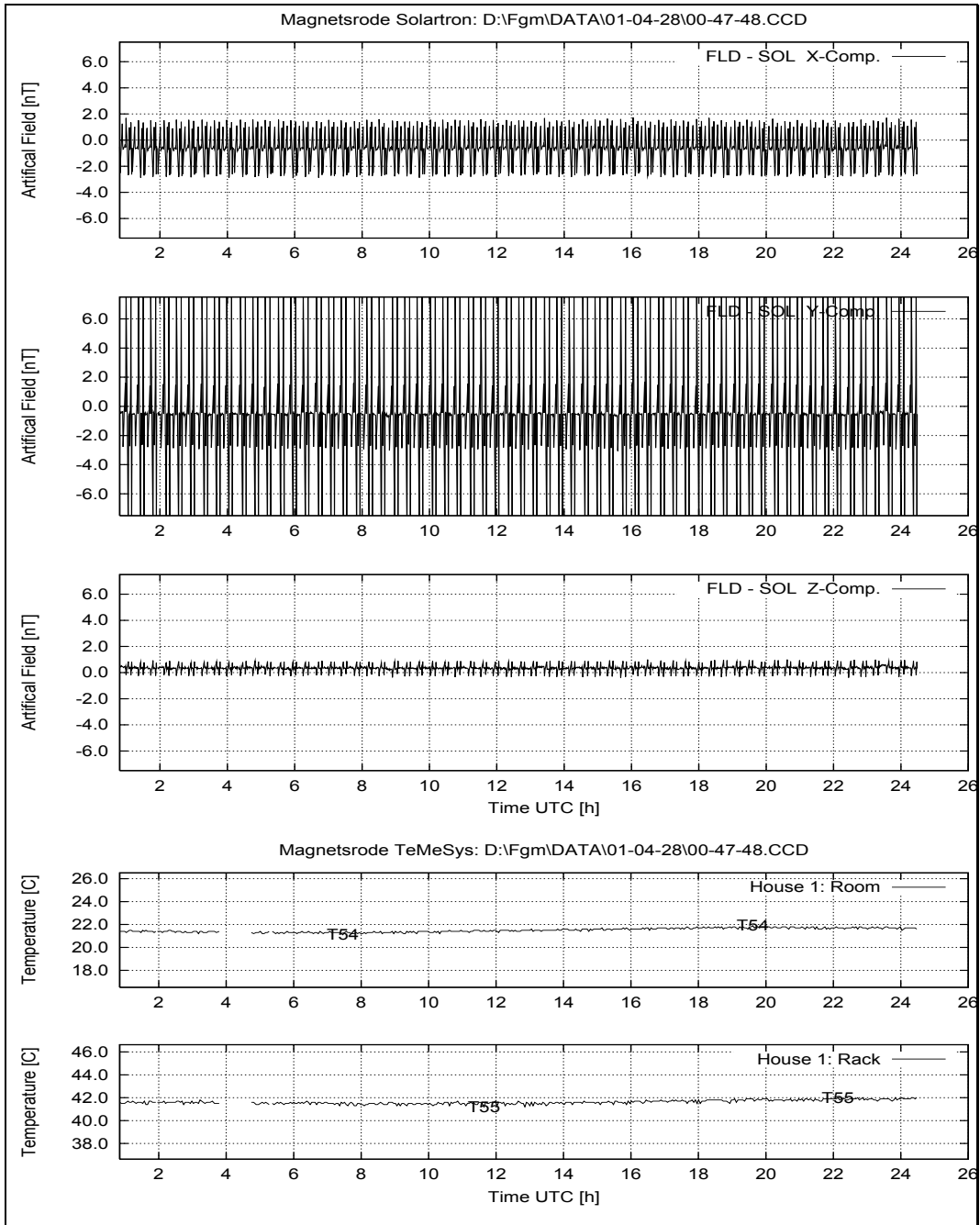

Figure 94: April 28, 2001: System Performance: FLD – SOL; Temperatures at House 1.

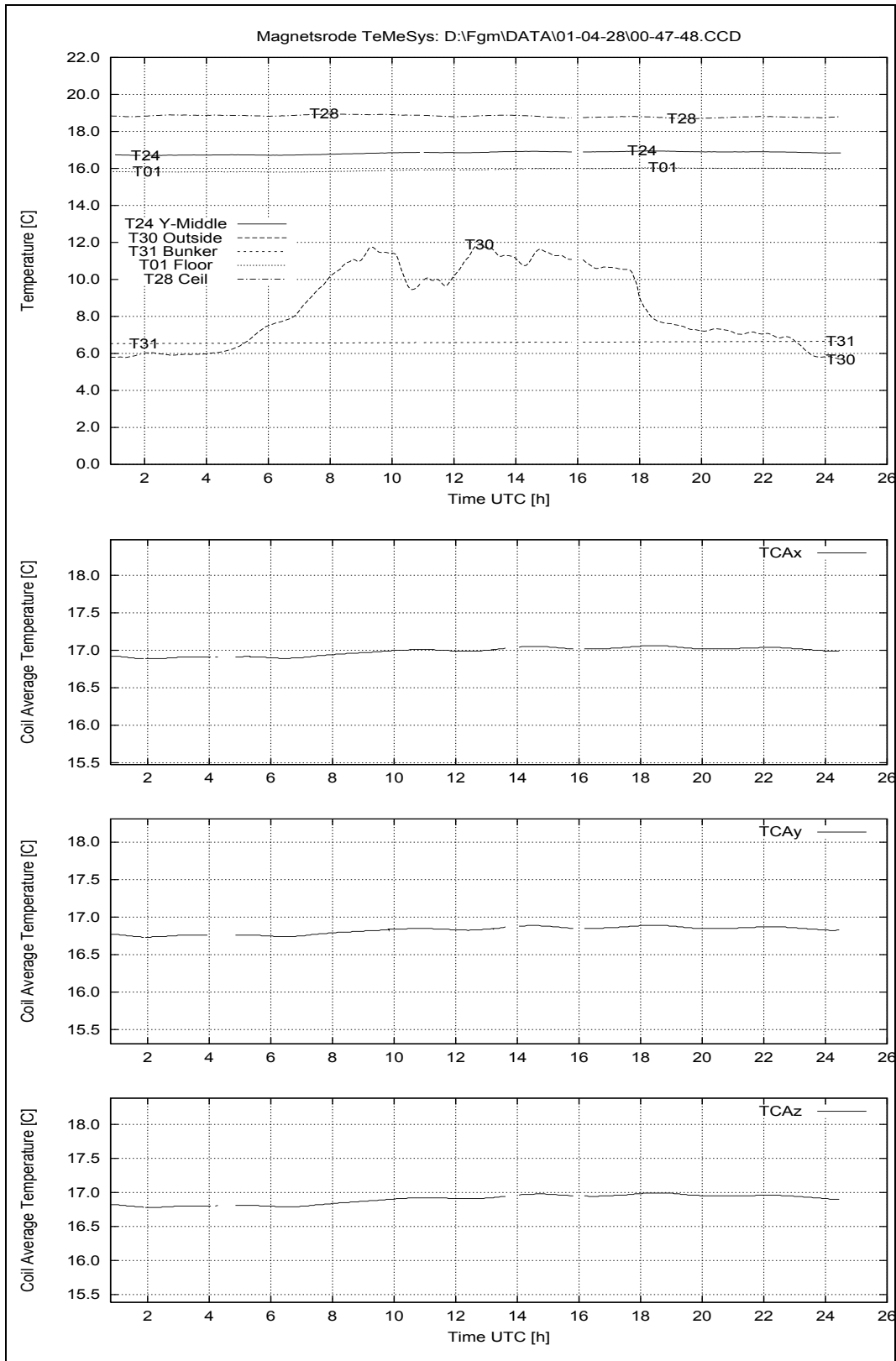

Figure 95: April 28, 2001: Temperatures House 2.

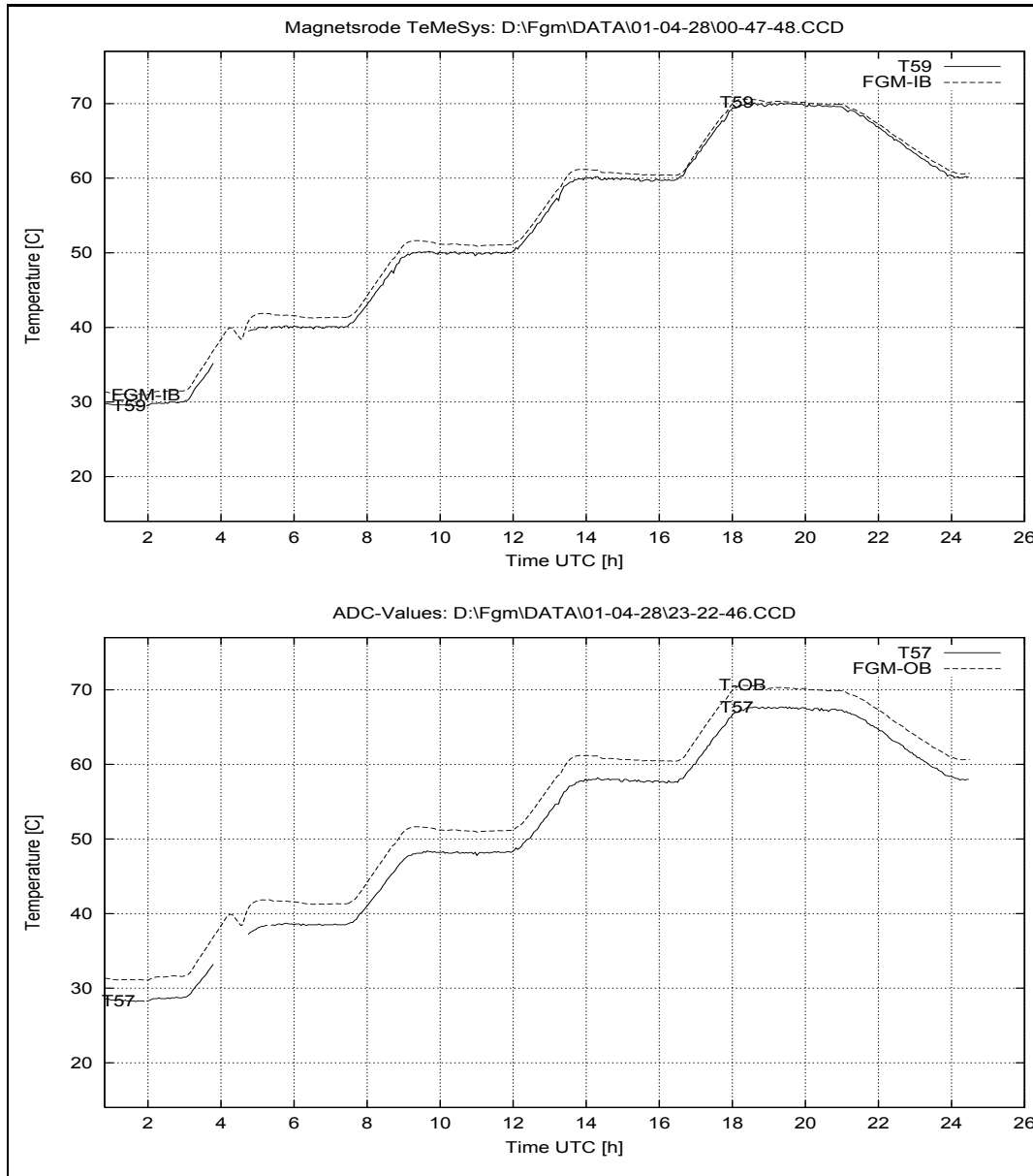

Figure 96: April 27, 2001: Sensor Temperatures at House 2.

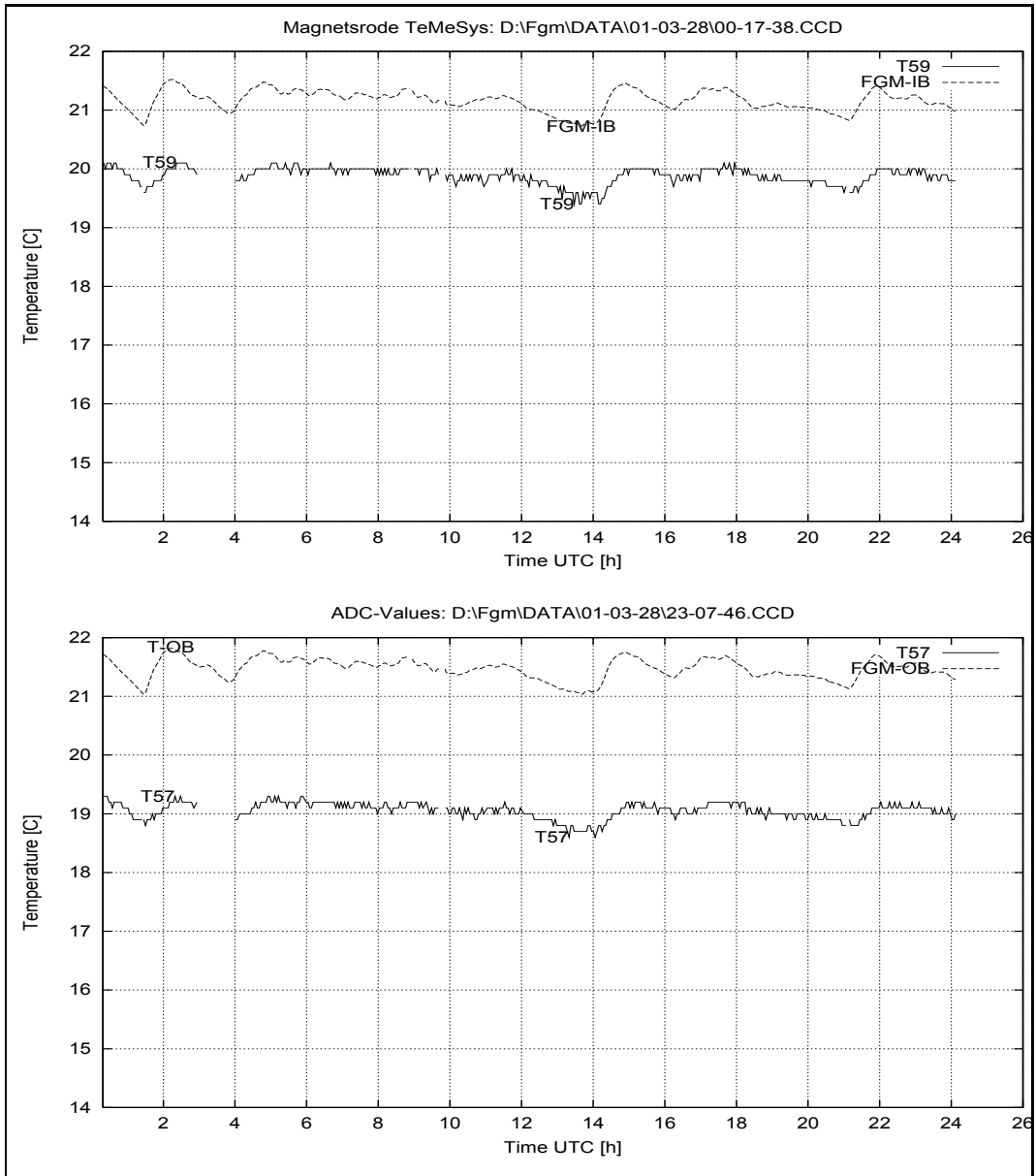

Figure 97: March 28, 2001: Sensor Temperatures at House 2.

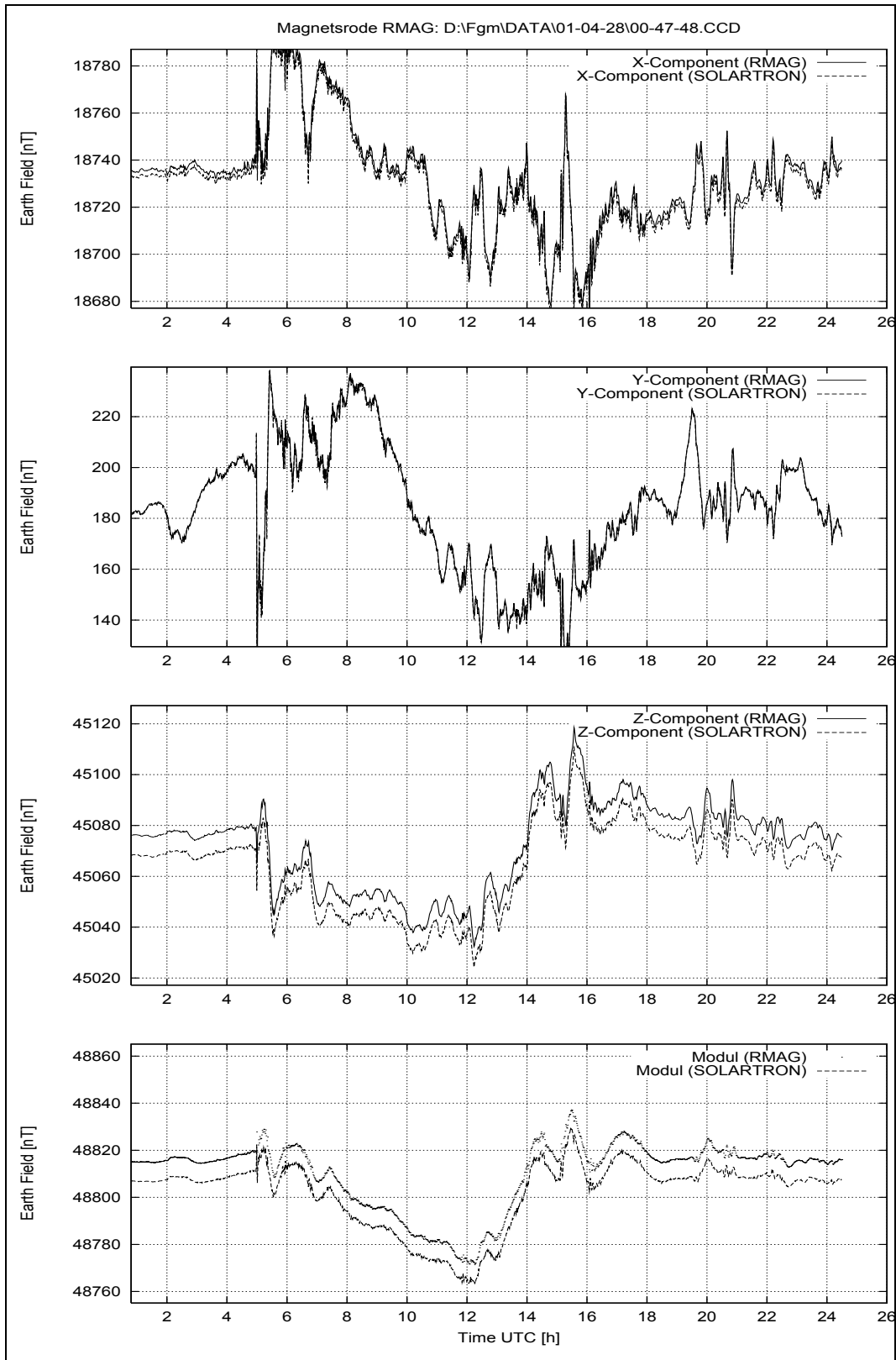

Figure 98: April 28, 2001: Earthfield variations.

R O S E T T A		Document: RO-IGM-TR-0002
		Issue: 2
		Revision: 2
IGM	Institut für Geophysik und Meteorologie Technische Universität Braunschweig	Date: October 10, 2001
		Page: 151

24 Sunday April 29, 2001

24.1 Temperature Calibration, Heating Cycle, FS Sensors, Continued

The execution of the temperature cycle according to ROSSETTA2.CUR continued today.
No personnel around today.

24.1.1 Data

Configuration File	CCD File	CCD File	Remark
TEMP.CFG	01-04-29\00_30_27.CCD	01-04-29\12_56_31.CCD	
TEMP.CFG	01-04-29\01_38_06.CCD	01-04-29\14_04_11.CCD	
TEMP.CFG	01-04-29\02_45_47.CCD	01-04-29\15_11_51.CCD	
TEMP.CFG	01-04-29\03_53_28.CCD	01-04-29\16_19_32.CCD	
TEMP.CFG	01-04-29\05_01_09.CCD	01-04-29\17_27_12.CCD	
TEMP.CFG	01-04-29\06_08_50.CCD	01-04-29\18_34_53.CCD	
TEMP.CFG	01-04-29\07_16_31.CCD	01-04-29\19_42_34.CCD	
TEMP.CFG	01-04-29\08_25_50.CCD	01-04-29\20_50_35.CCD	
TEMP.CFG	01-04-29\09_33_30.CCD	01-04-29\21_58_16.CCD	
TEMP.CFG	01-04-29\10_41_10.CCD	01-04-29\23_05_56.CCD	
TEMP.CFG	01-04-29\11_48_50.CCD		

24.2 Overview Plots: System Performance, Temperatures and Earth-field Variations.

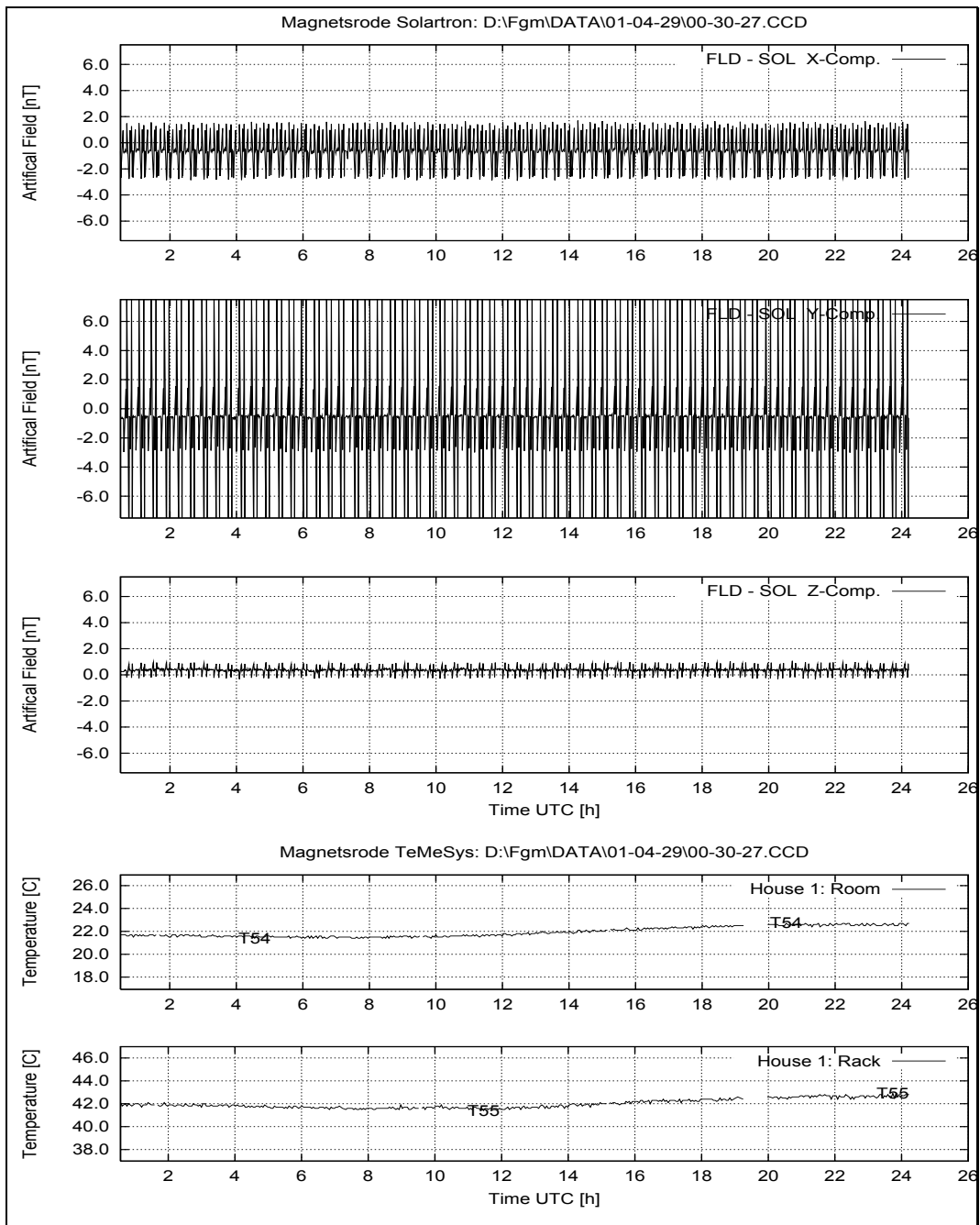

Figure 99: April 29, 2001: System Performance: FLD – SOL; Temperatures at House 1.

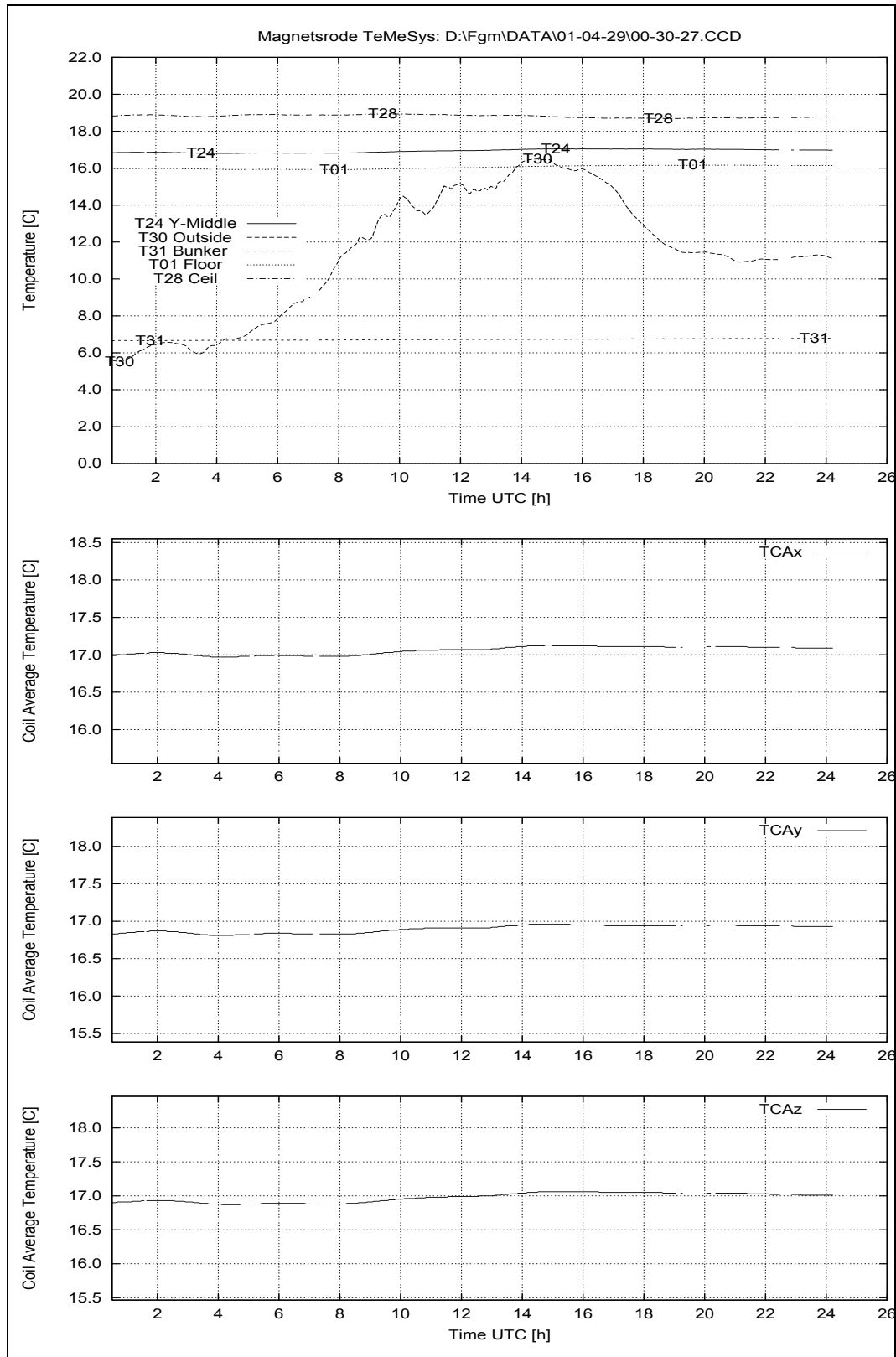

Figure 100: April 29, 2001: Temperatures House 2.

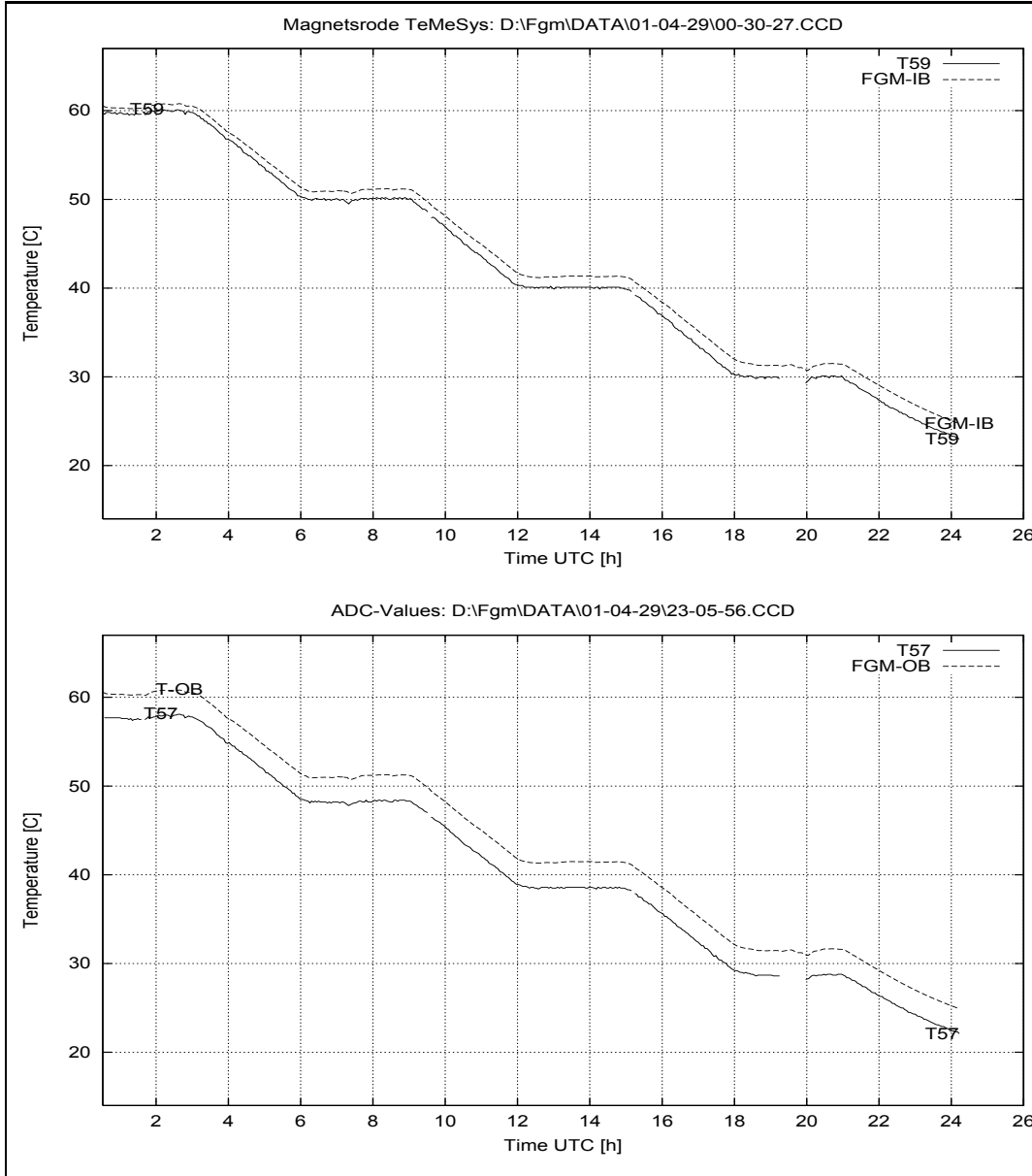

Figure 101: April 29, 2001: Sensor Temperatures at House 2.

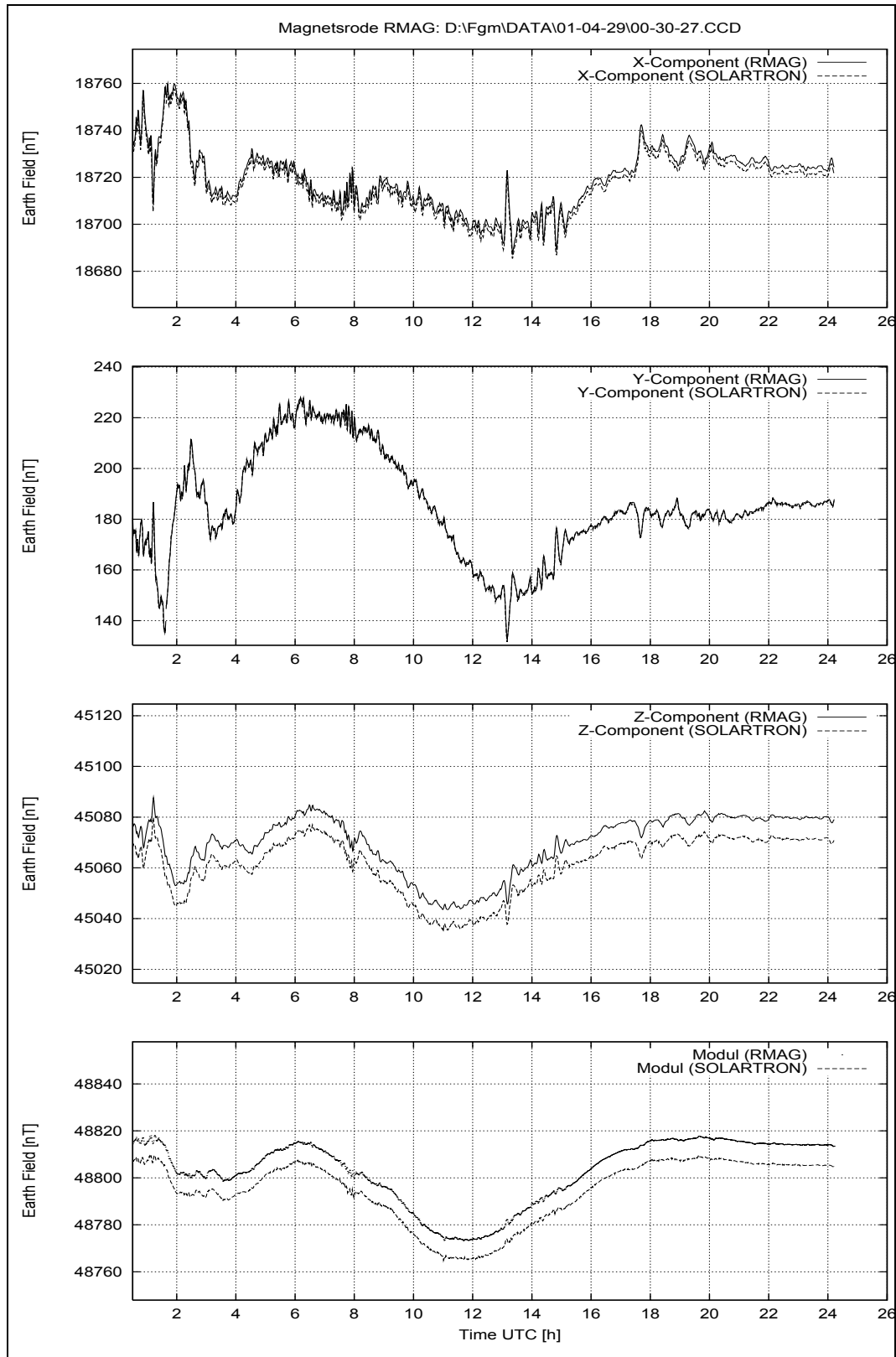

Figure 102: April 29, 2001: Earthfield variations.

R O S E T T A		Document: RO-IGM-TR-0002
		Issue: 2
		Revision: 2
IGM	Institut für Geophysik und Meteorologie Technische Universität Braunschweig	Date: October 10, 2001
		Page: 156

25 Monday April 30, 2001

25.1 Temperature Calibration, Heating Cycle, FS Sensors, Continued

The execution of the temperature cycle according to ROSSETTA2.CUR continued today.
No personnel around today.

25.1.1 Data

Configuration File	CCD File	CCD File	Remark
TEMP.CFG	01-04-30\00_13_37.CCD	01-04-30\12_38_00.CCD	
TEMP.CFG	01-04-30\01_21_17.CCD	01-04-30\13_45_42.CCD	
TEMP.CFG	01-04-30\02_28_58.CCD	01-04-30\14_53_22.CCD	
TEMP.CFG	01-04-30\03_36_39.CCD	01-04-30\16_01_03.CCD	
TEMP.CFG	01-04-30\04_44_20.CCD	01-04-30\17_08_43.CCD	
TEMP.CFG	01-04-30\05_51_59.CCD	01-04-30\18_16_25.CCD	
TEMP.CFG	01-04-30\06_59_39.CCD	01-04-30\19_24_06.CCD	
TEMP.CFG	01-04-30\08_07_20.CCD	01-04-30\20_31_45.CCD	
TEMP.CFG	01-04-30\09_15_01.CCD	01-04-30\21_39_27.CCD	
TEMP.CFG	01-04-30\10_22_40.CCD	01-04-30\22_47_08.CCD	
TEMP.CFG	01-04-30\11_30_21.CCD	01-04-30\23_54_48.CCD	

25.2 Overview Plots: System Performance, Temperatures and Earth-field Variations.

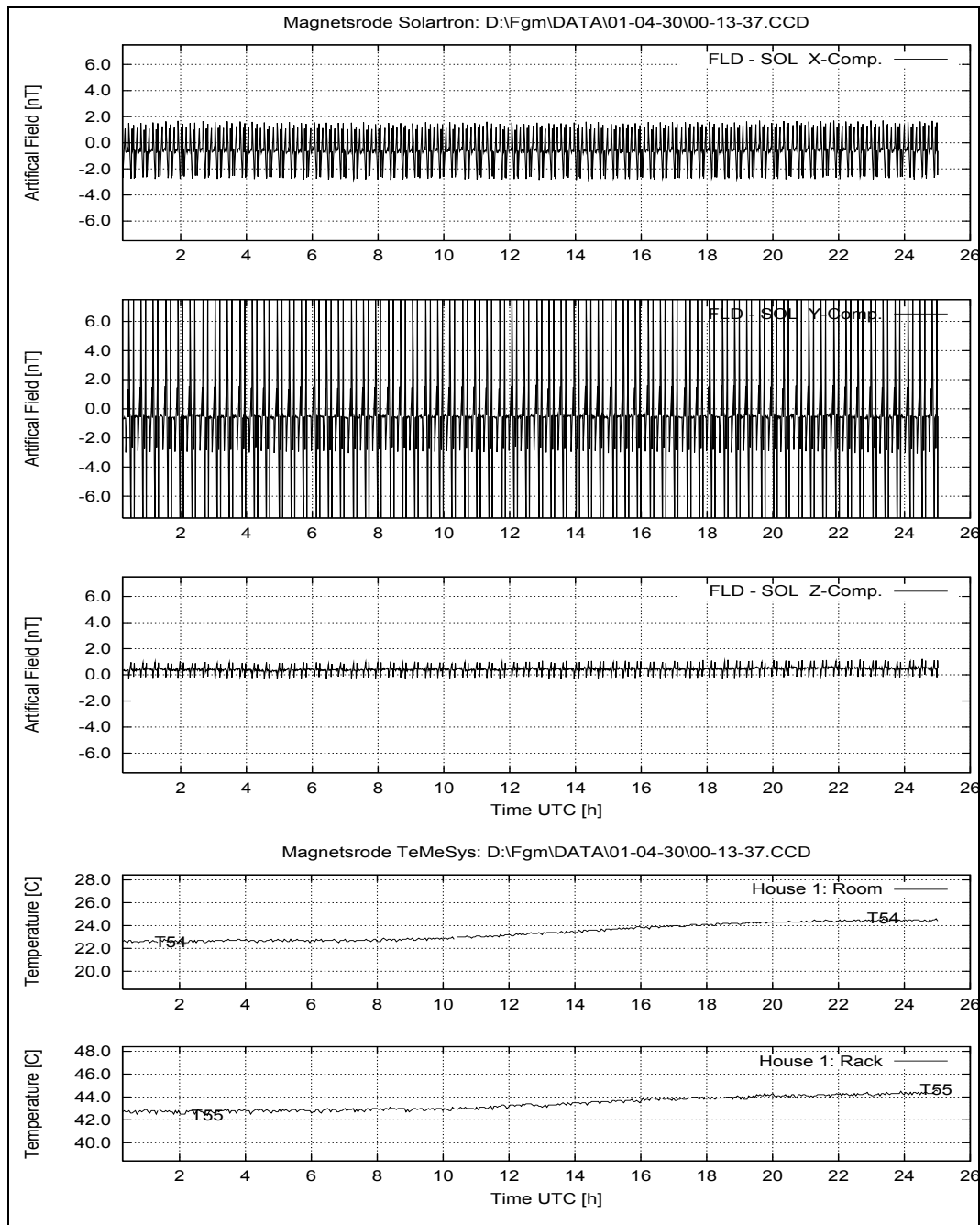

Figure 103: April 30, 2001: System Performance: FLD – SOL; Temperatures at House 1.

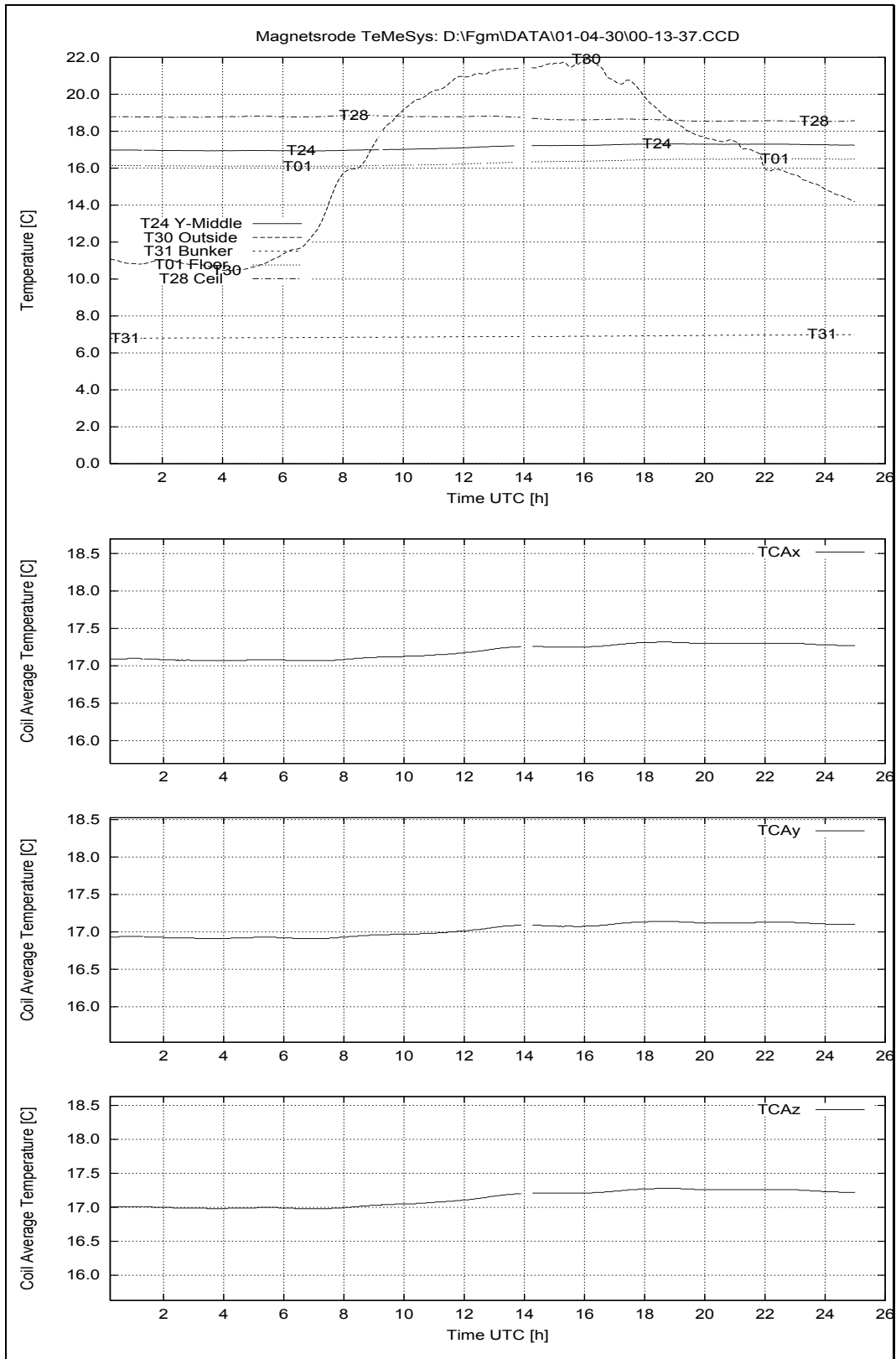

Figure 104: April 30, 2001: Temperatures House 2.

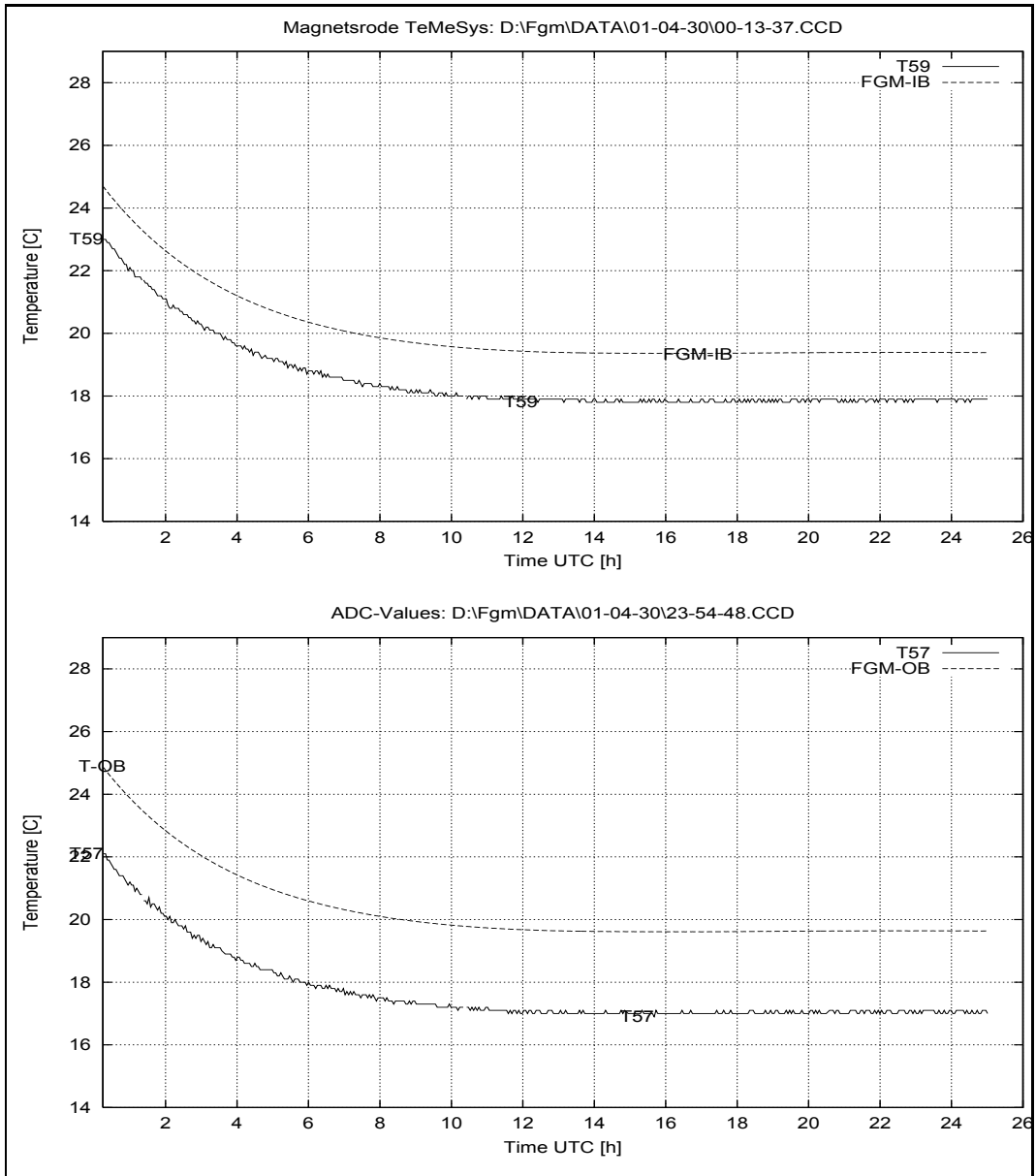

Figure 105: April 30, 2001: Sensor Temperatures at House 2.

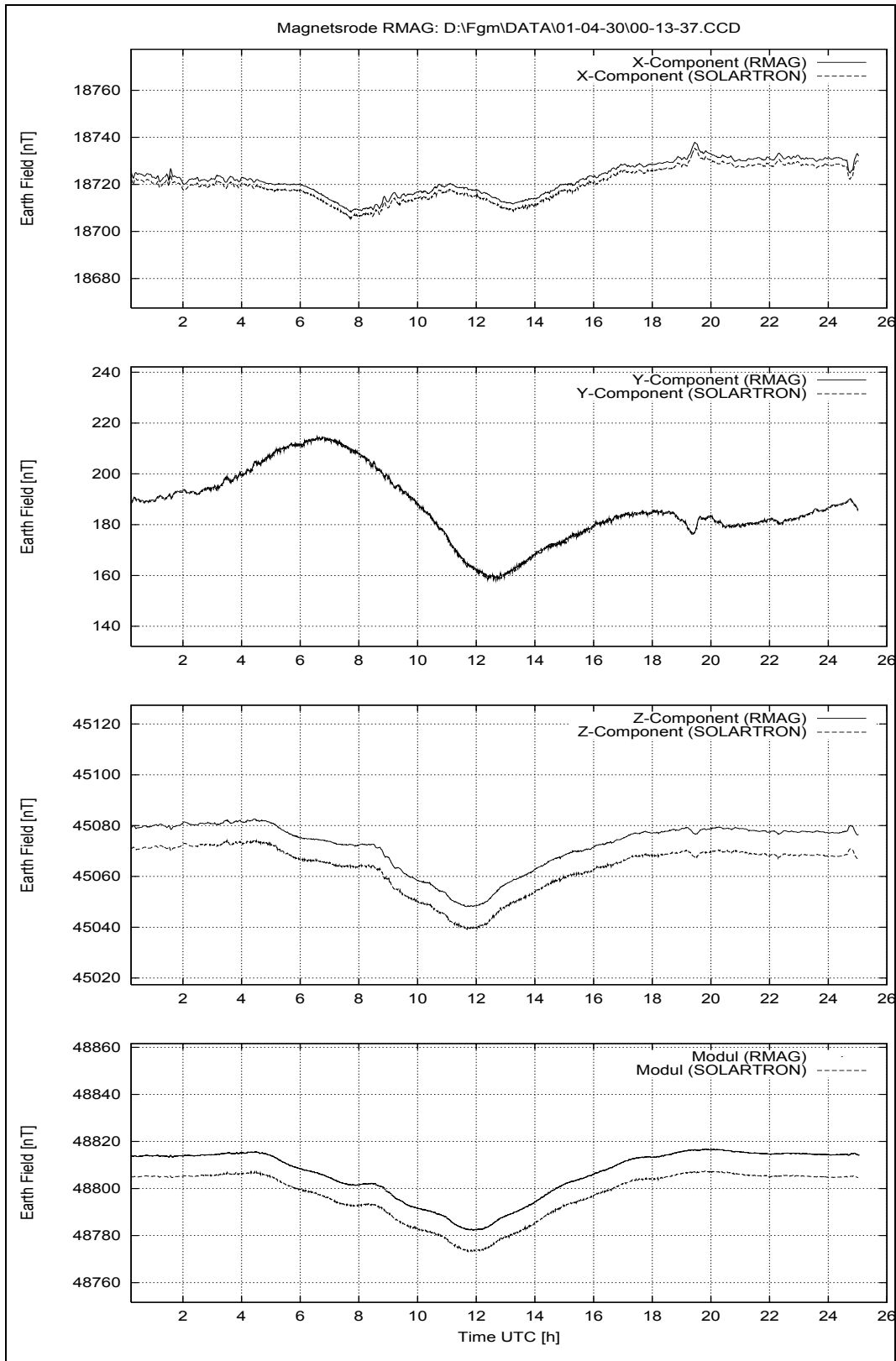

Figure 106: April 30, 2001: Earthfield variations.

R O S E T T A		Document: RO-IGM-TR-0002
IGM Institut für Geophysik und Meteorologie Technische Universität Braunschweig		Issue: 2
		Revision: 2
		Date: October 10, 2001
		Page: 161

26 Tuesday May 1, 2001

26.1 Temperature Calibration, Heating Cycle, FS Sensors, Continued

The execution of the temperature cycle according to ROSSETTA2.CUR continued today.
No personnel around today.

26.1.1 Data

Configuration File	CCD File	CCD File	Remark
TEMP.CFG	01-05-01\01_02_28.CCD	01-05-01\12_19_49.CCD	
TEMP.CFG	01-05-01\02_10_26.CCD	01-05-01\13_27_29.CCD	
TEMP.CFG	01-05-01\03_18_06.CCD	01-05-01\14_35_09.CCD	
TEMP.CFG	01-05-01\04_25_46.CCD	01-05-01\15_42_50.CCD	
TEMP.CFG	01-05-01\05_33_27.CCD	01-05-01\16_50_31.CCD	
TEMP.CFG	01-05-01\06_41_07.CCD	01-05-01\17_58_12.CCD	
TEMP.CFG	01-05-01\07_48_47.CCD	01-05-01\19_05_53.CCD	
TEMP.CFG	01-05-01\08_56_27.CCD	01-05-01\20_13_34.CCD	
TEMP.CFG	01-05-01\10_04_07.CCD	01-05-01\21_21_15.CCD	
TEMP.CFG	01-05-01\11_11_48.CCD	01-05-01\22_30_32.CCD	

26.2 Temperature Cycle, Linearities, FS Sensors

At the end of the temperature calibration the usual linearity measurements after the T-cycle were executed in the chosen setup for the temperature cycle. The sensors are fixed and unchanged

Purpose: Measure the linearity of the FGM-FS sensors.
Conditions: FS-OB and FS-IB placed in the Thermal Test Box on the aluminium support. The distance between them is 150 mm.
MAD: Ch0 to Ch2 connected to Zopfmag x to z, 10 nT/mV;
Ch7 FSP;
Timer 500, SumUp 100, Vectorrate 1.00 Hz.
Files: T_LIN.SEQ embedded in TEMP.SEQ
Start: 01.05.01 23:38
End: 02.05.01 01:42

R O S E T T A		Document: RO-IGM-TR-0002
		Issue: 2
		Revision: 2
IGM	Institut für Geophysik und Meteorologie	Date: October 10, 2001
	Technische Universität Braunschweig	Page: 162

26.2.1 Data

Configuration File	CCD File
ALI10.CFG	01-05-01\23_38_13.CCD
TX15.CFG	01-05-01\23_45_24.CCD
TY15.CFG	01-05-01\23_58_24.CCD

26.3 Overview Plots: System Performance, Temperatures and Earth-field Variations.

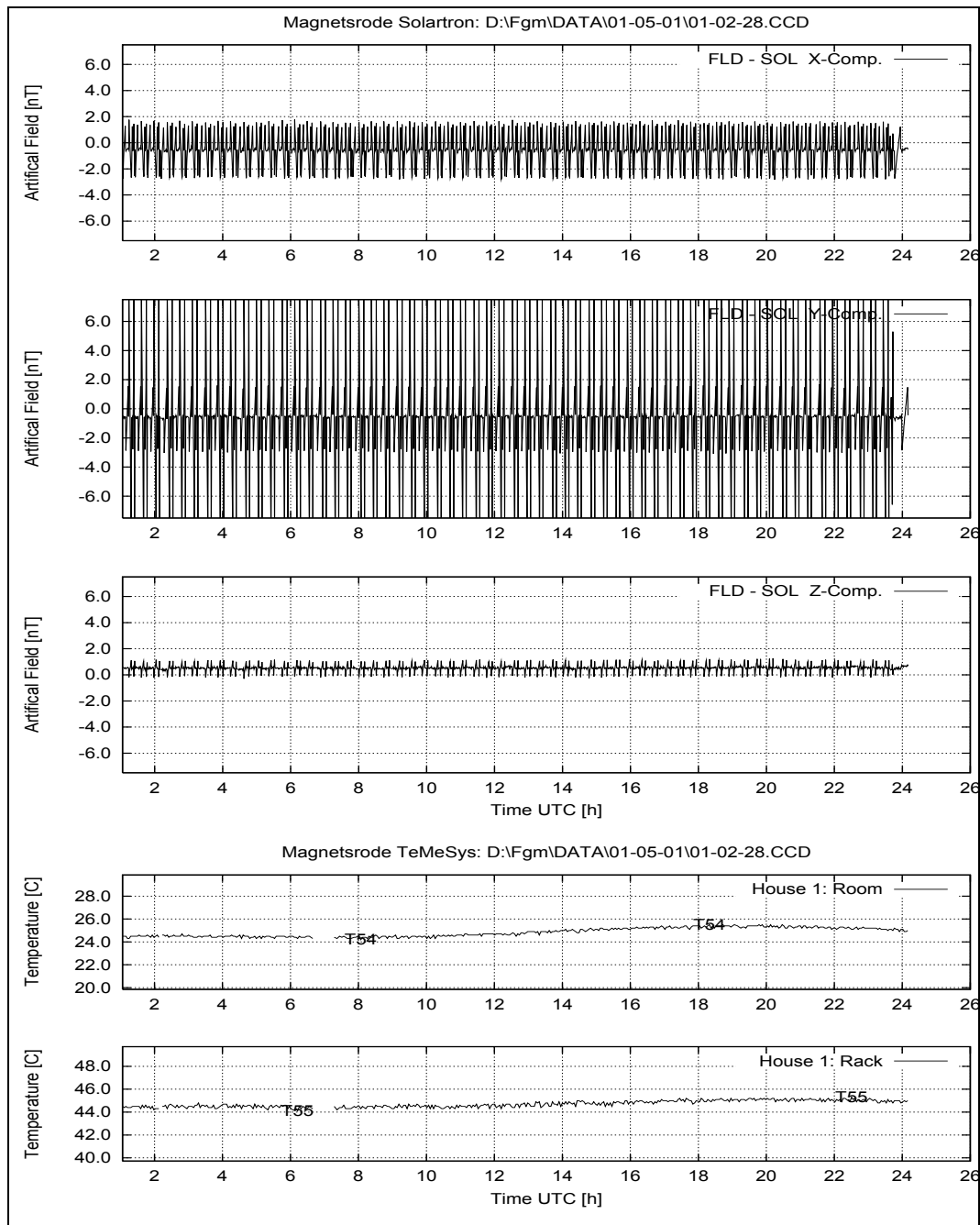

Figure 107: May 1, 2001: System Performance: FLD – SOL; Temperatures at House 1.

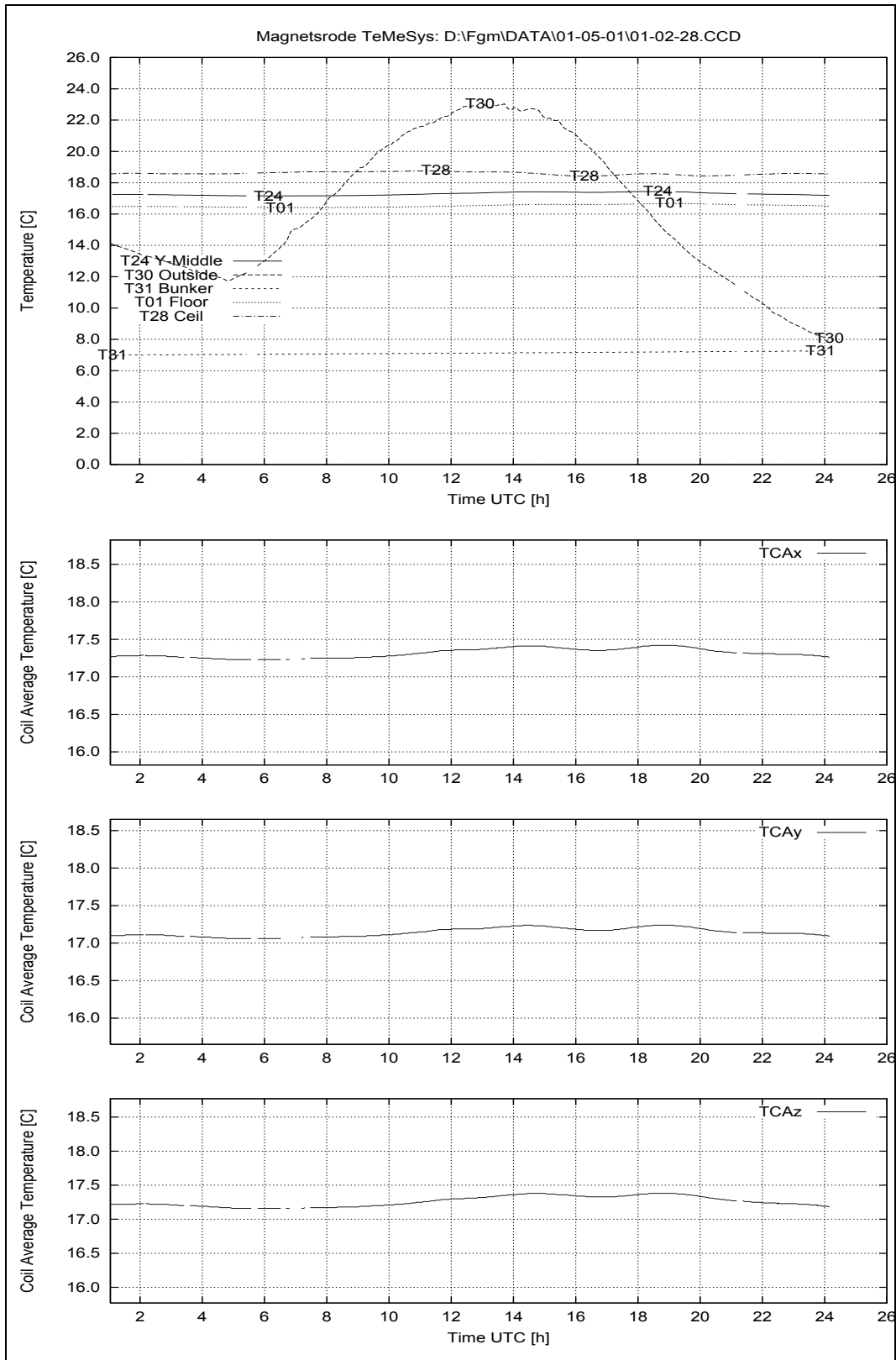

Figure 108: May 1, 2001: Temperatures House 2.

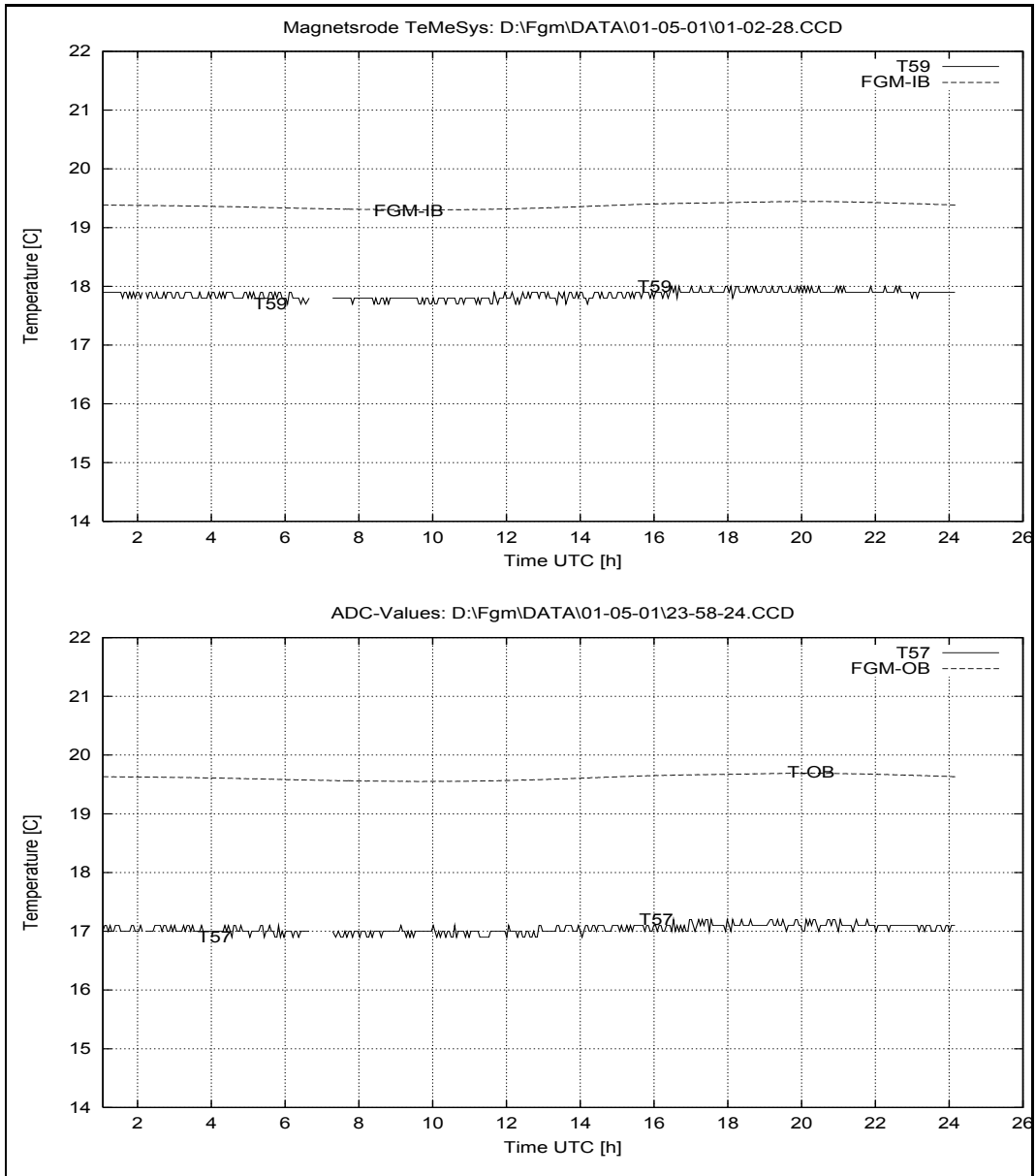

Figure 109: Mai 1, 2001: Sensor Temperatures at House 2.

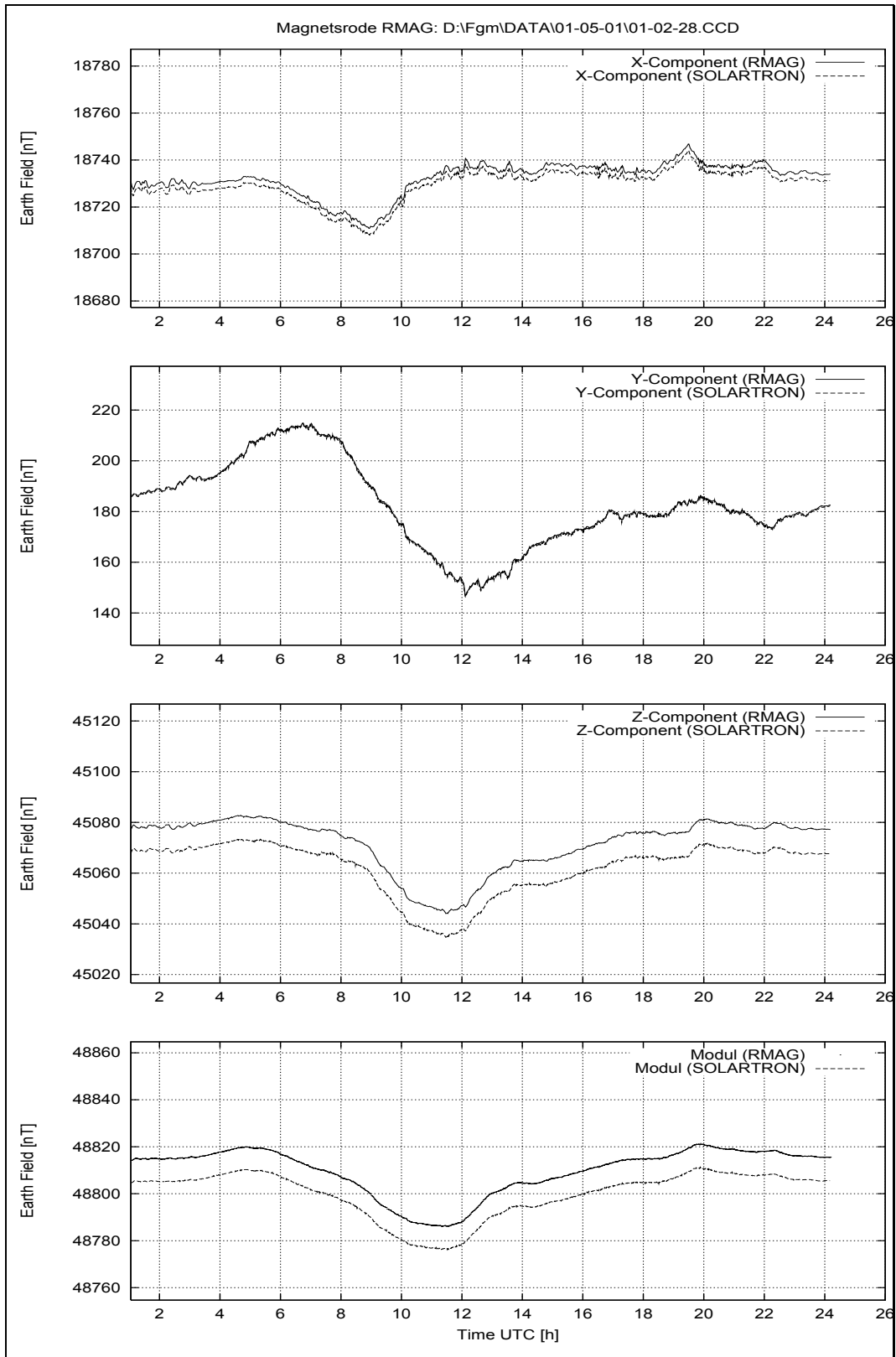

Figure 110: May 1, 2001: Earthfield variations.

R O S E T T A		Document: RO-IGM-TR-0002
		Issue: 2
		Revision: 2
IGM	Institut für Geophysik und Meteorologie	Date: October 10, 2001
	Technische Universität Braunschweig	Page: 167

27 Wednesday May 2, 2001

27.1 Temperature Cycle, Linearities, FS Sensors

The remaining measurements of the linearity sequence were performed in the early morning.

27.1.1 Data

Configuration File	CCD File
TZ15.CFG	01-05-02\00_11_24.CCD
TX15.CFG	01-05-02\00_24_25.CCD
TY15.CFG	01-05-02\00_37_25.CCD
TZ15.CFG	01-05-02\00_50_25.CCD
TX15.CFG	01-05-02\01_03_26.CCD
TY15.CFG	01-05-02\01_16_25.CCD
TZ15.CFG	01-05-02\01_29_26.CCD

27.2 Overview Plots: System Performance, Temperatures and Earth-field Variations.

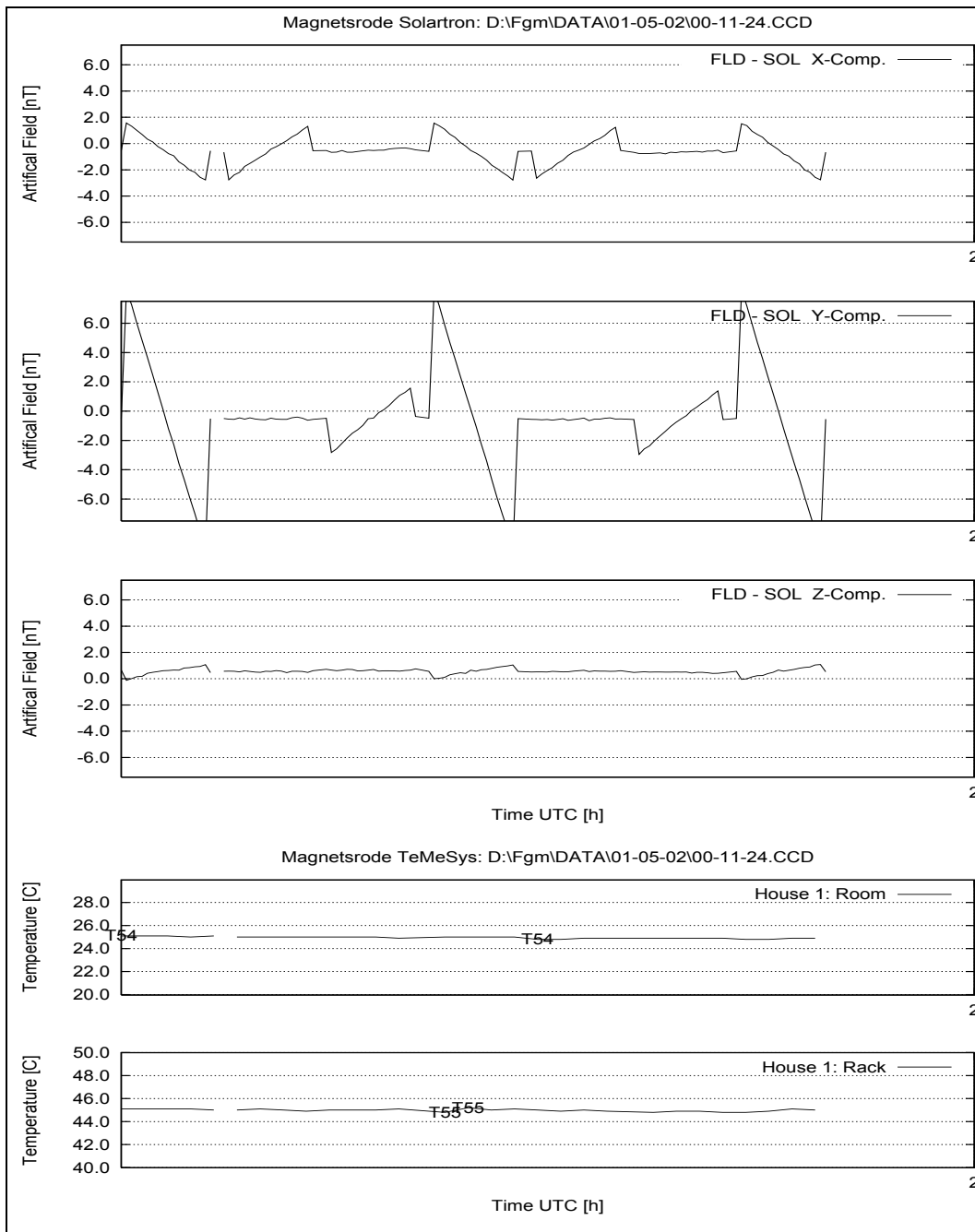

Figure 111: May 2, 2001: System Performance: FLD – SOL; Temperatures at House 1.

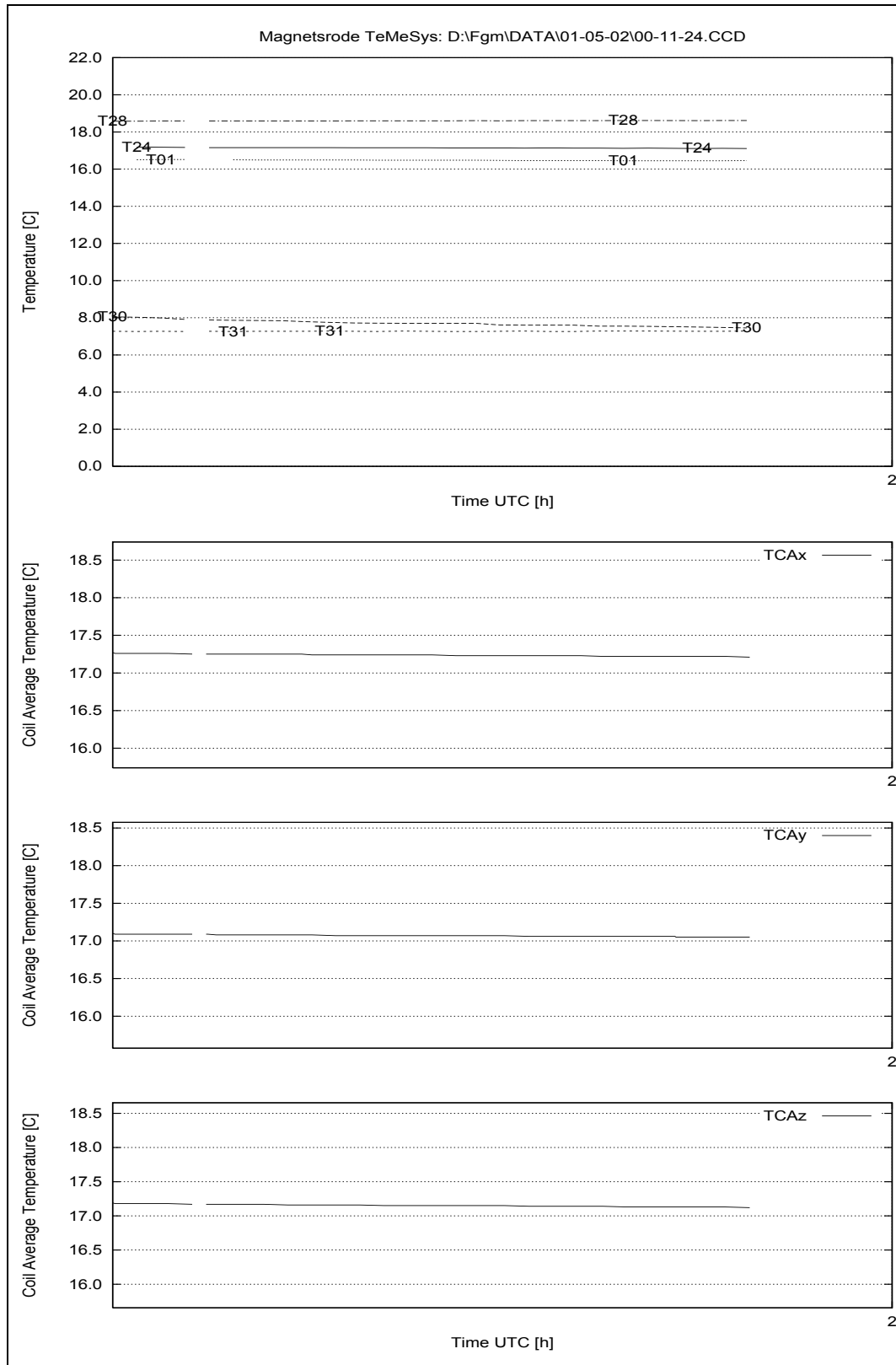

Figure 112: May 2, 2001: Temperatures House 2.

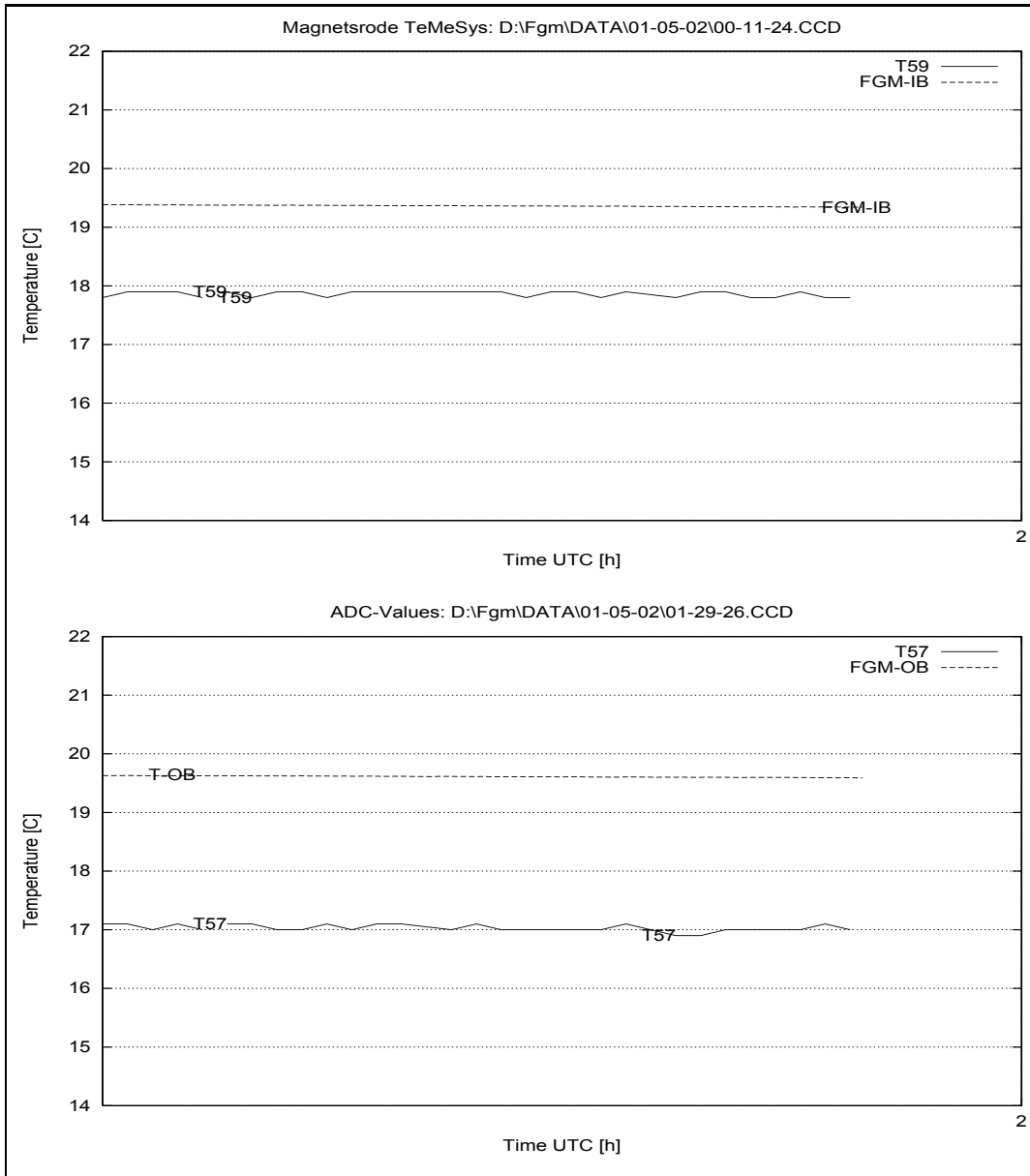

Figure 113: Mai 2, 2001: Sensor Temperatures at House 2.

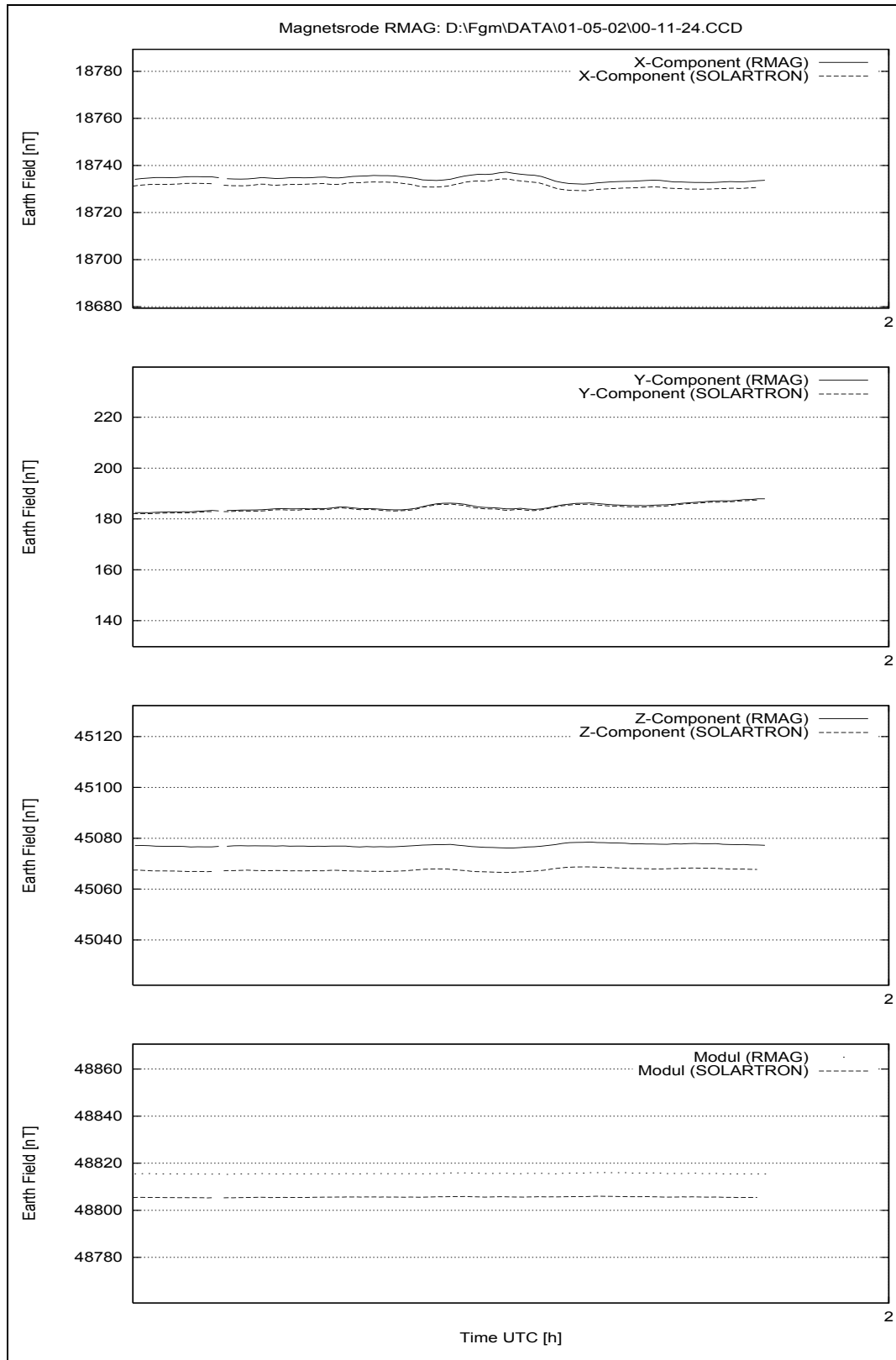

Figure 114: May 2, 2001: Earthfield variations.

28 Tuesday August 28, 2001

28.1 Pre Calibration Residual Field Adjustment

After a break of four month the residual field of the coil system had to be checked and nulled before the new calibration measurements. For this purpose the Overhauser Magnetometer (OVH) was placed diagonally in space in the center of the coil system (CoC). The orientation of the sensor was from south-west-down to north-east-up. Refer to picture 267. Fields have been applied with the S/W MCF_CTRL. The data output of the OVH was logged with HYPERTERM on a Laptop in House 1.

Initial measurement:

Component	Applied Field [nT]	Measured Modulus [nT]	Residual Field [nT]	Old PA-Offset
X	+50000	49991	+00	458
X	-50000	49991		
Y	+50000	50014	+23	560
Y	-50000	49967		
Z	+50000	49995	-5	600
Z	-50000	50004		

Status after adjustment:

Component	Applied Field [nT]	Measured Modulus [nT]	Residual Field [nT]	Old PA-Offset
X	+50000	49991	00	458
X	-50000	49991		
Y	+50000	49991	00	355
Y	-50000	50091		
Z	+50000	49999	00	645
Z	-50000	49999		

The measurement stability was not as good as at the residual field check at the beginning of the ROSETTA calibration. Most likely there were some higher frequent radiation or induction at the coil system. Nevertheless the result is confident at enough.

28.2 Setup for the Temperature Calibration

Both sensors, mounted together on their aluminium support, are fixed on the mounting plate of the Thermal Test Box. See figure 115 for details. Also a photographic view (figures 266 will help.

The FM-OB is on the northern side, FM-IB on the southern side. The temperature sensors of the TEMESYS-B system T₅₆ to T₆₃ are placed in the box. The positions are given in table 5.

Sensor	Position
T ₅₇	under FGM-OB sensor
T ₅₉	under FGM-IB sensor
T ₅₆	mounting plate, upper side, western edge, central
T ₅₈	mounting plate, upper side, south west corner
T ₂₉	outside thermal box at the northern side of the Coil System
T ₆₀	ground plate, north middle
T ₆₁	mounting plate, eastern side, central
T ₆₂	ground plate, south west
T ₆₃	ground plate, south east

Table 5: The TEMESYS-B sensors in the Thermal Test Box.

R O S E T T A	Document: RO-IGM-TR-0002
IGM	Issue: 2
	Revision: 2
	Date: October 10, 2001
Institut für Geophysik und Meteorologie Technische Universität Braunschweig	Page: 174

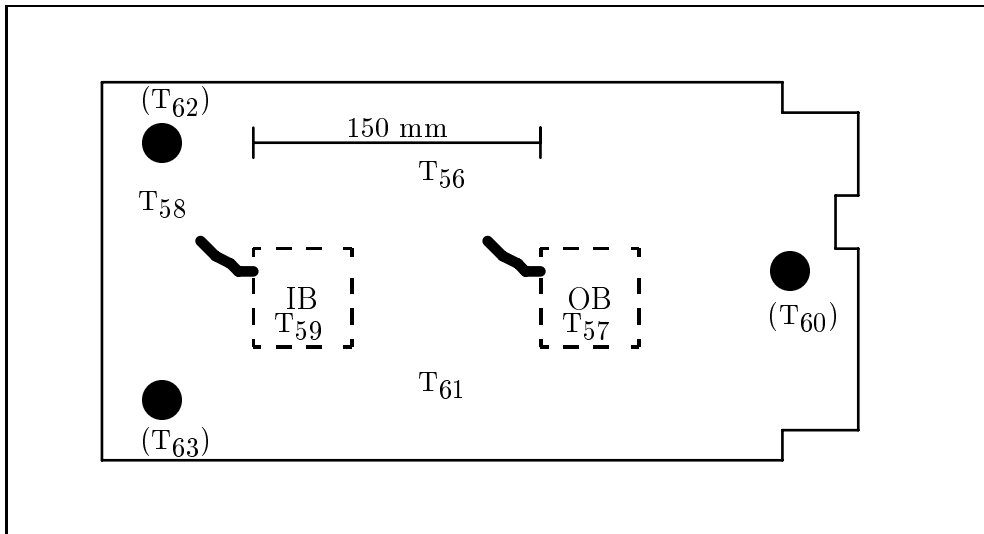

Figure 115: The temperature sensors at the Thermal Test Box mounting plate. The draft shows the top view. Sensors in brackets are mounted near the Thermal Test Box ground plate, not on the mounting plate.

The software `TEMPCTRL` is used to control the heating process. This software switches on the electrical heater during the `SOLARTRON` measurement cycle. This was done, because during the `SOLARTRON` measurements the data should not be used and so they may be disturbed anyway. For details on the heater and the control software see the related document *MR-IGM-TN0005*. The appendix E gives details on the measurements and shows an overview on the complete cooling and heating cycle.

As the power supply onboard the ROSETTA s/c is supposed to be 5.1 V rather than 5.0 V all the following calibration steps are executed with the external power supply set to ' \pm Nominal + 2 %' which means $\pm 5.1V$.

28.3 Temperature Cycle, Linearities, DPU:FS, Sensors: FS

Before the temperature calibration will be performed some linearity measurements should be executed in the chosen setup for the temperature cycle. The sensors are fixed, but the box is still open for filling in the dry ice after these measurements.

R O S E T T A		Document: RO-IGM-TR-0002
		Issue: 2
		Revision: 2
IGM	Institut für Geophysik und Meteorologie Technische Universität Braunschweig	Date: October 10, 2001
		Page: 175

Purpose: Measure the linearity of the FGM-FS sensors using the FS DPU.
Conditions: FS-OB and FS-IB placed in the Thermal Test Box on the aluminium support. The distance between them is 150 mm.
MAD: Ch0 to Ch2 connected to Zopfmag x to z, 10 nT/mV;
Ch7 FSP; Lower Reference position
Timer 500, SumUp 100, Vectorrate 1.00 Hz.
Files: T_LIN.SEQ
Start: 28.08.01 11:25
End: 28.08.01 11:58

28.3.1 Data

Configuration File	CCD File
all10.CFG	01-08-28\11_25_10.CCD
TX15.CFG	01-08-28\11_32_31.CCD
TY15.CFG	01-08-28\11_45_32.CCD
TZ15.CFG	01-08-28\11_58_33.CCD

28.4 Temperature Calibration, Heating Cycle, DPU:FS, Sensors: FS

Purpose: Measure the temperature behaviour of the FS sensors using the FS DPU.
Conditions: FS-OB and FS-IB placed in the Thermal Test Box on the aluminium support. The distance between them is 150 mm.
MAD: Ch0 to Ch2 connected to Zopfmag x to z, 10 nT/mV;
Ch7 FSP;
Timer 500, SumUp 100, Vectorrate 1.00 Hz.
Files: TEMP3.SEQ
Temperature
File: ROSETTA3.CUR
Tctrlparam. FLDtime: 40 s – TCctrl times: 12 s / 20s
Start: 28.08.01 13:26
End: 30.08.01 13:00 ESC.

28.4.1 Data

Configuration File	CCD File	CCD file
TEMP.CFG	01-08-28\12_14_04.CCD	01-08-28\19_00_13.CCD
TEMP.CFG	01-08-28\13_21_46.CCD	01-08-28\20_07_55.CCD
TEMP.CFG	01-08-28\14_29_27.CCD	01-08-28\21_15_36.CCD
TEMP.CFG	01-08-28\15_37_08.CCD	01-08-28\22_23_17.CCD
TEMP.CFG	01-08-28\16_44_50.CCD	01-08-28\23_30_58.CCD
TEMP.CFG	01-08-28\17_52_32.CCD	

28.5 Overview Plots: System Performance, Temperatures and Earth-field Variations.

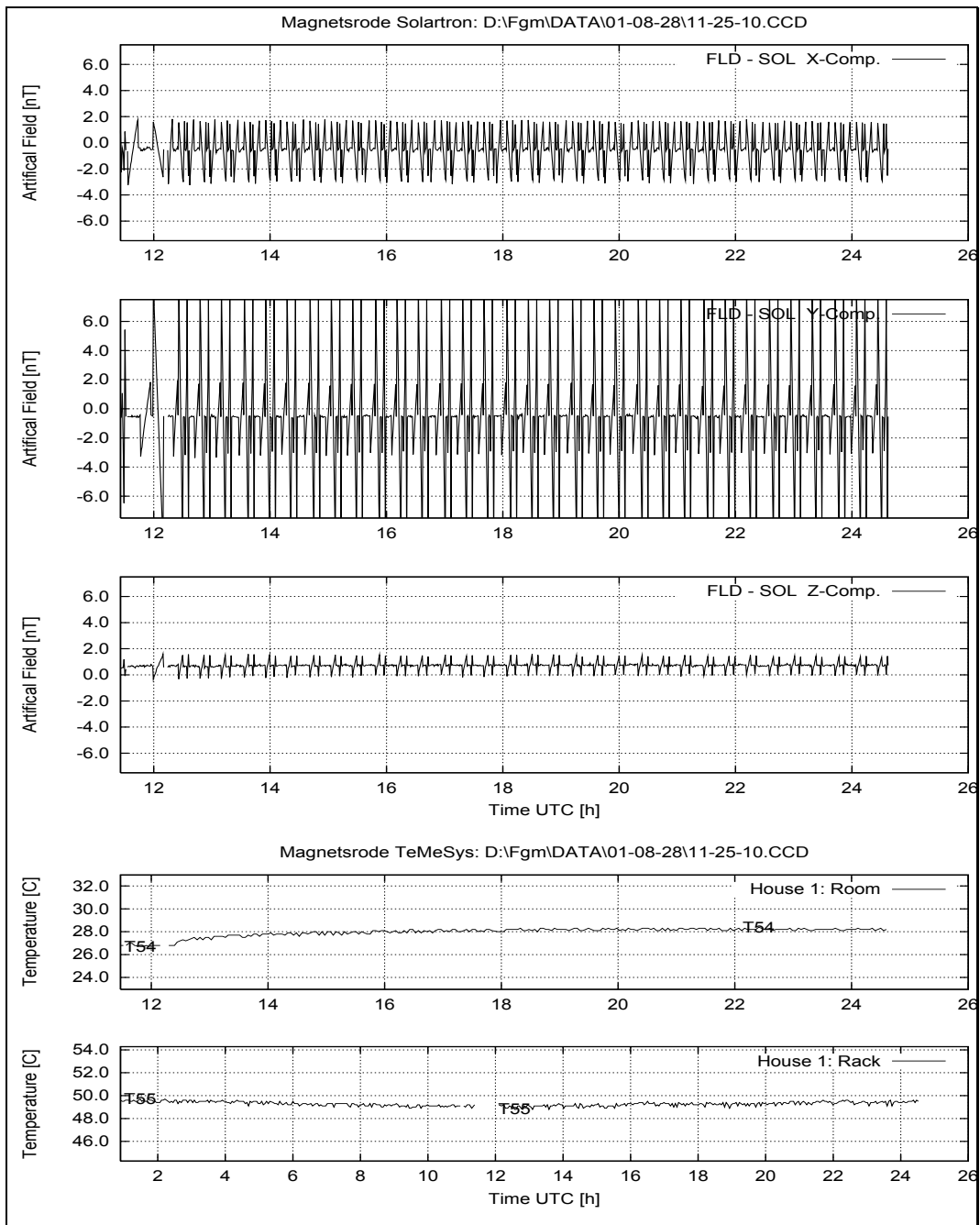

Figure 116: August 28, 2001: System Performance: FLD – SOL; Temperatures House 1.

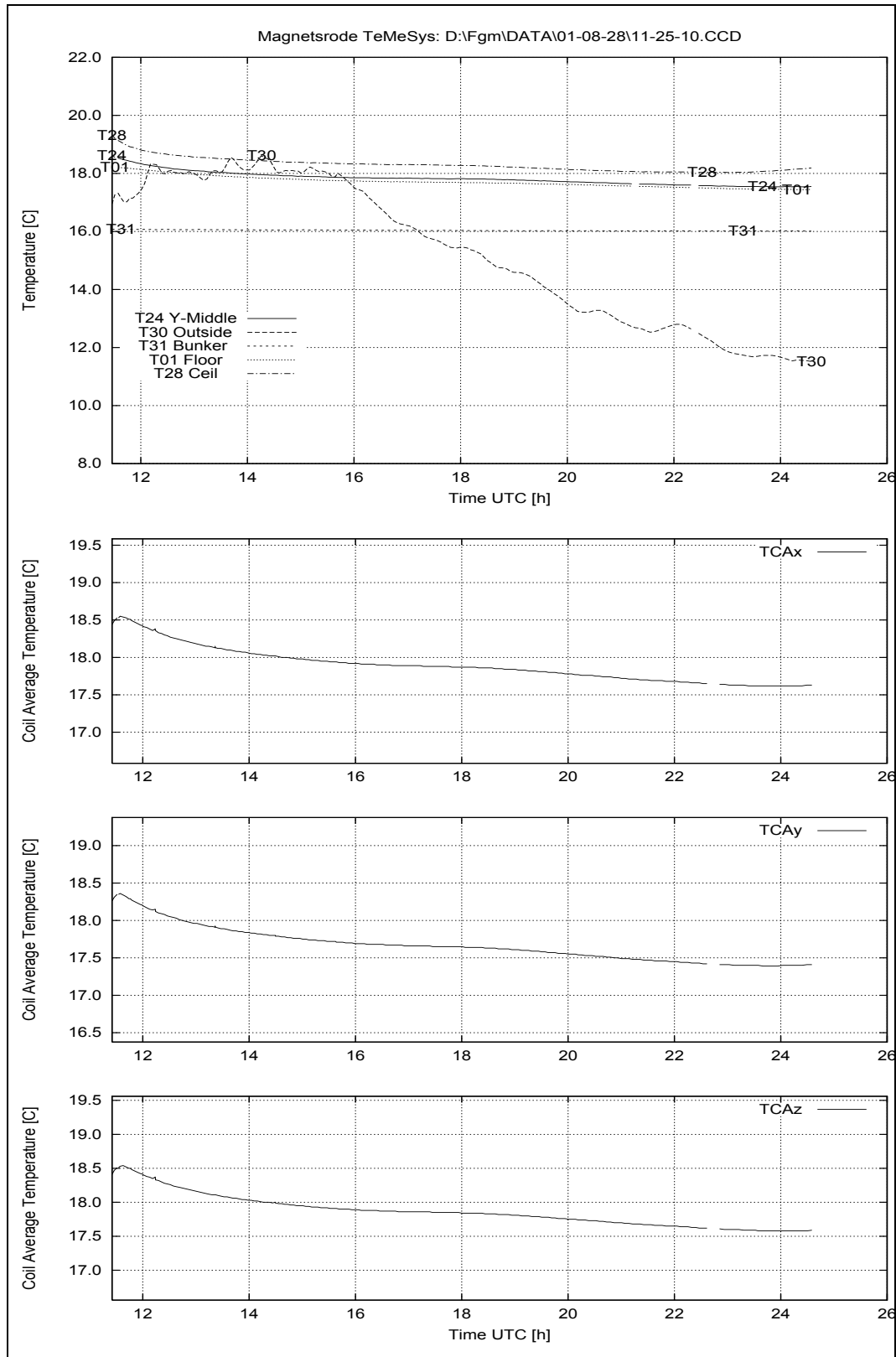

Figure 117: August 28, 2001: Temperatures House 2.

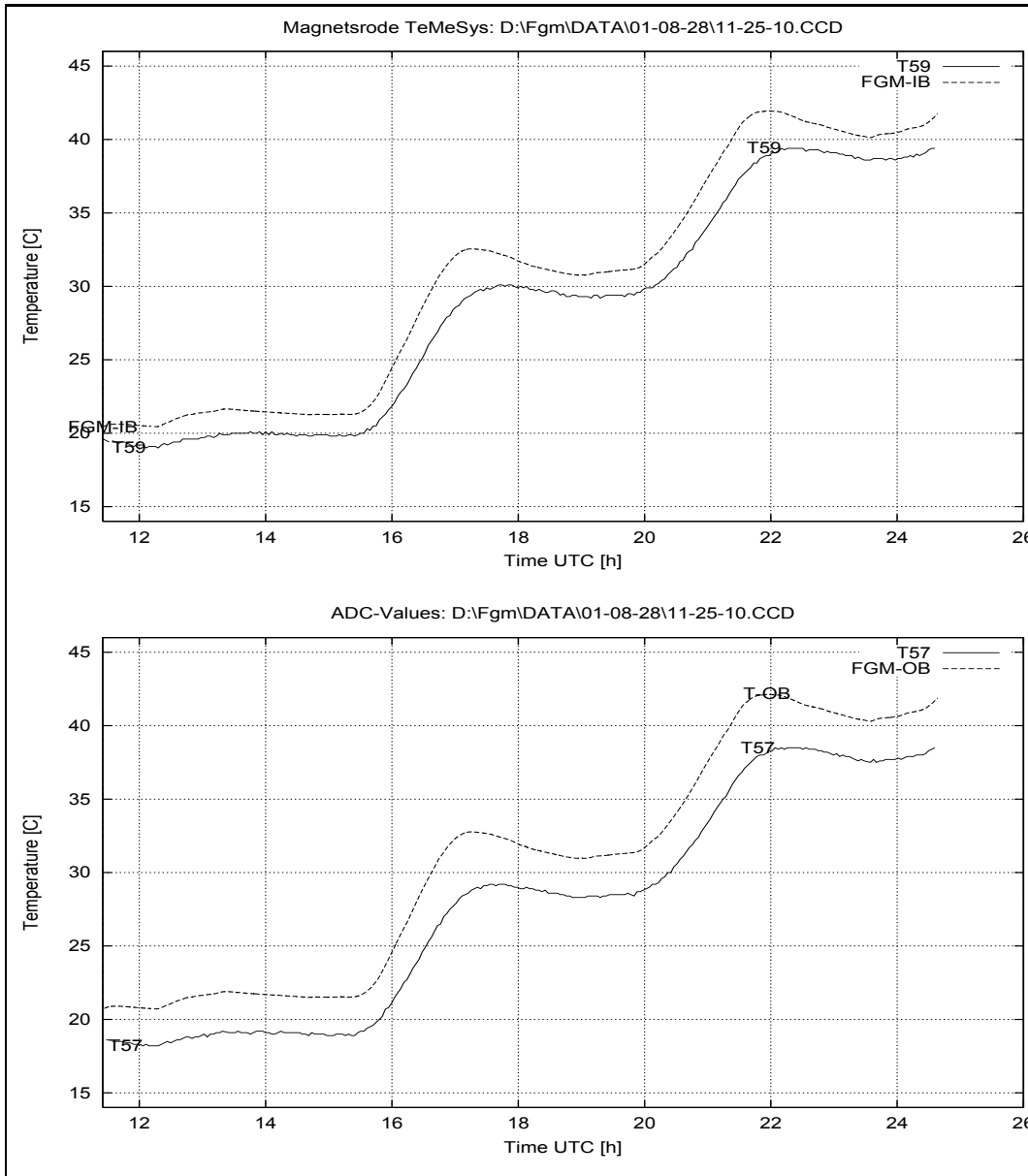

Figure 118: August 28, 2001: Sensor Temperatures at House 2.

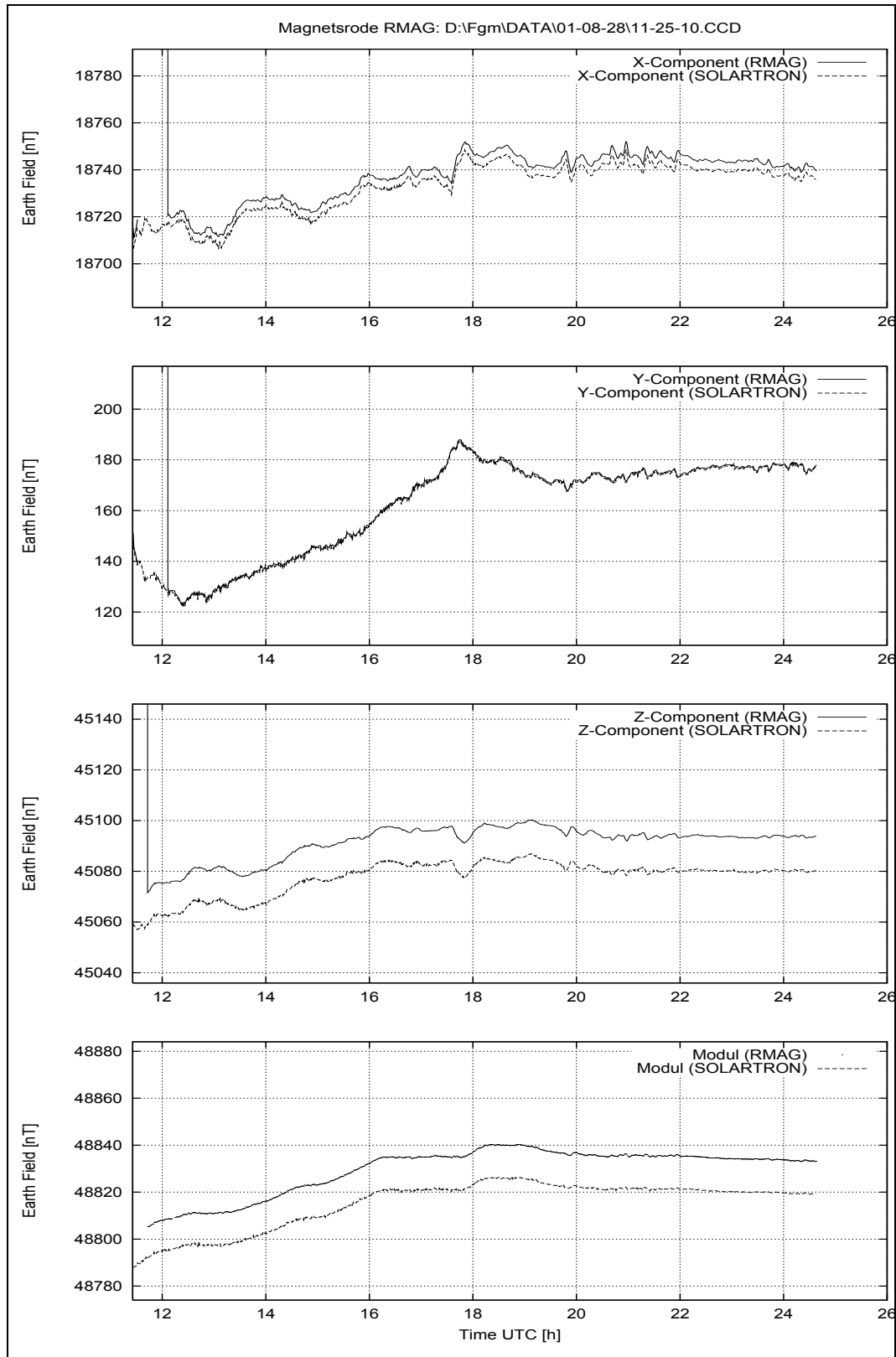

Figure 119: August 28, 2001: Earthfield variations.

R O S E T T A	Document: RO-IGM-TR-0002
IGM	Issue: 2
	Revision: 2
	Date: October 10, 2001
Institut für Geophysik und Meteorologie Technische Universität Braunschweig	Page: 180

29 Wednesday August 29, 2001

29.1 Temperature Calibration, Heating Cycle continued, DPU:FS, Sensors: FS

The heating cycle continued without any personal support today.

29.1.1 Data

Configuration File	CCD File	Remark
TEMP.CFG	01-08-29\00_38_40.CCD	
TEMP.CFG	01-08-29\01_46_21.CCD	
TEMP.CFG	01-08-29\02_54_02.CCD	
TEMP.CFG	01-08-29\04_01_42.CCD	
TEMP.CFG	01-08-29\05_09_24.CCD	
TEMP.CFG	01-08-29\06_17_05.CCD	
TEMP.CFG	01-08-29\07_24_48.CCD	
TEMP.CFG	01-08-29\08_32_29.CCD	
TEMP.CFG	01-08-29\09_40_10.CCD	
TEMP.CFG	01-08-29\10_47_52.CCD	
TEMP.CFG	01-08-29\11_55_33.CCD	
TEMP.CFG	01-08-29\13_03_14.CCD	
TEMP.CFG	01-08-29\14_10_55.CCD	
TEMP.CFG	01-08-29\15_18_36.CCD	
TEMP.CFG	01-08-29\16_26_17.CCD	
TEMP.CFG	01-08-29\17_34_27.CCD	
TEMP.CFG	01-08-29\18_42_08.CCD	
TEMP.CFG	01-08-29\19_49_50.CCD	
TEMP.CFG	01-08-29\20_57_31.CCD	
TEMP.CFG	01-08-29\22_05_12.CCD	
TEMP.CFG	01-08-29\23_12_54.CCD	

29.2 Overview Plots: System Performance, Temperatures and Earth-field Variations.

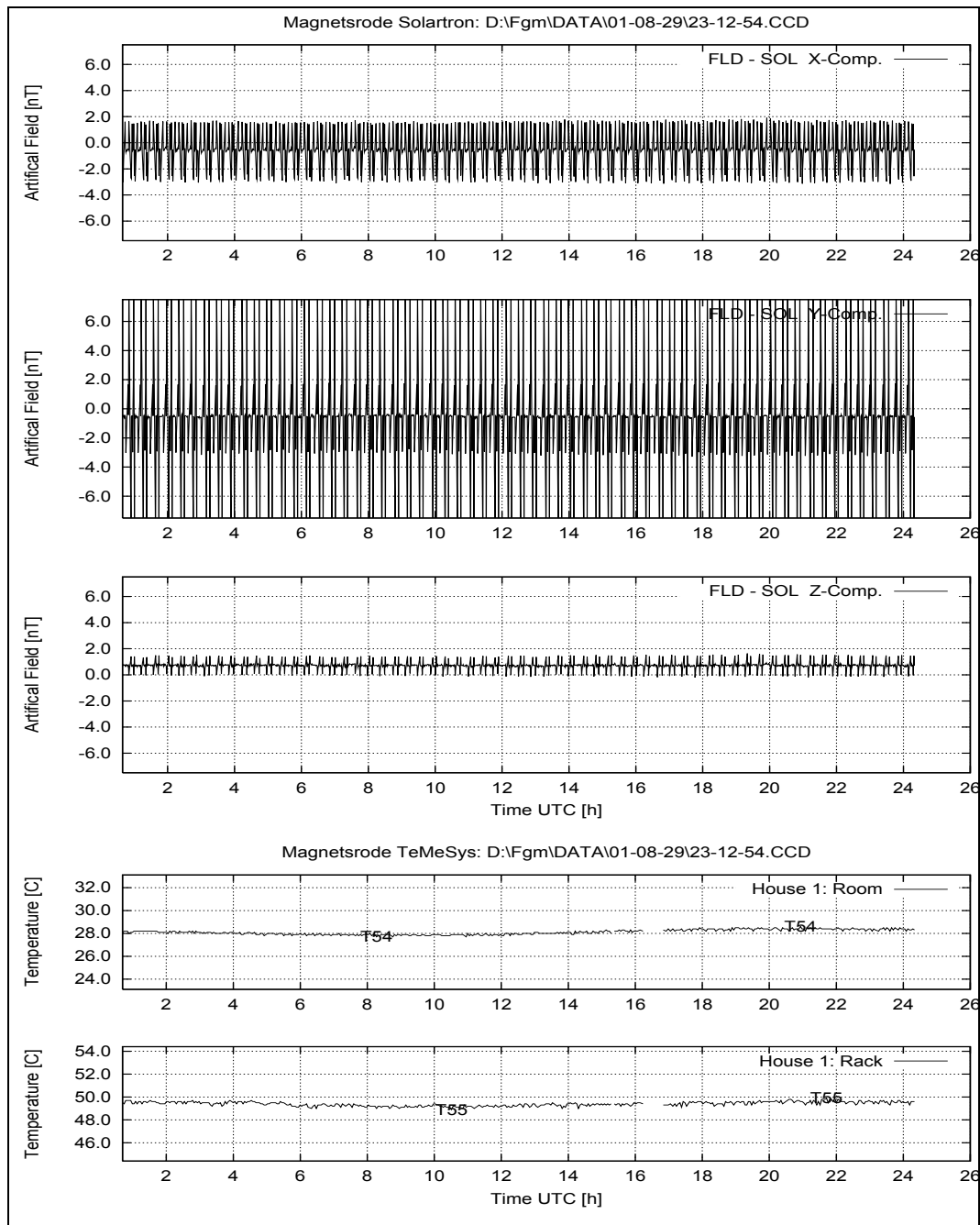

Figure 120: August 29, 2001: System Performance: FLD – SOL; Temperatures House 1.

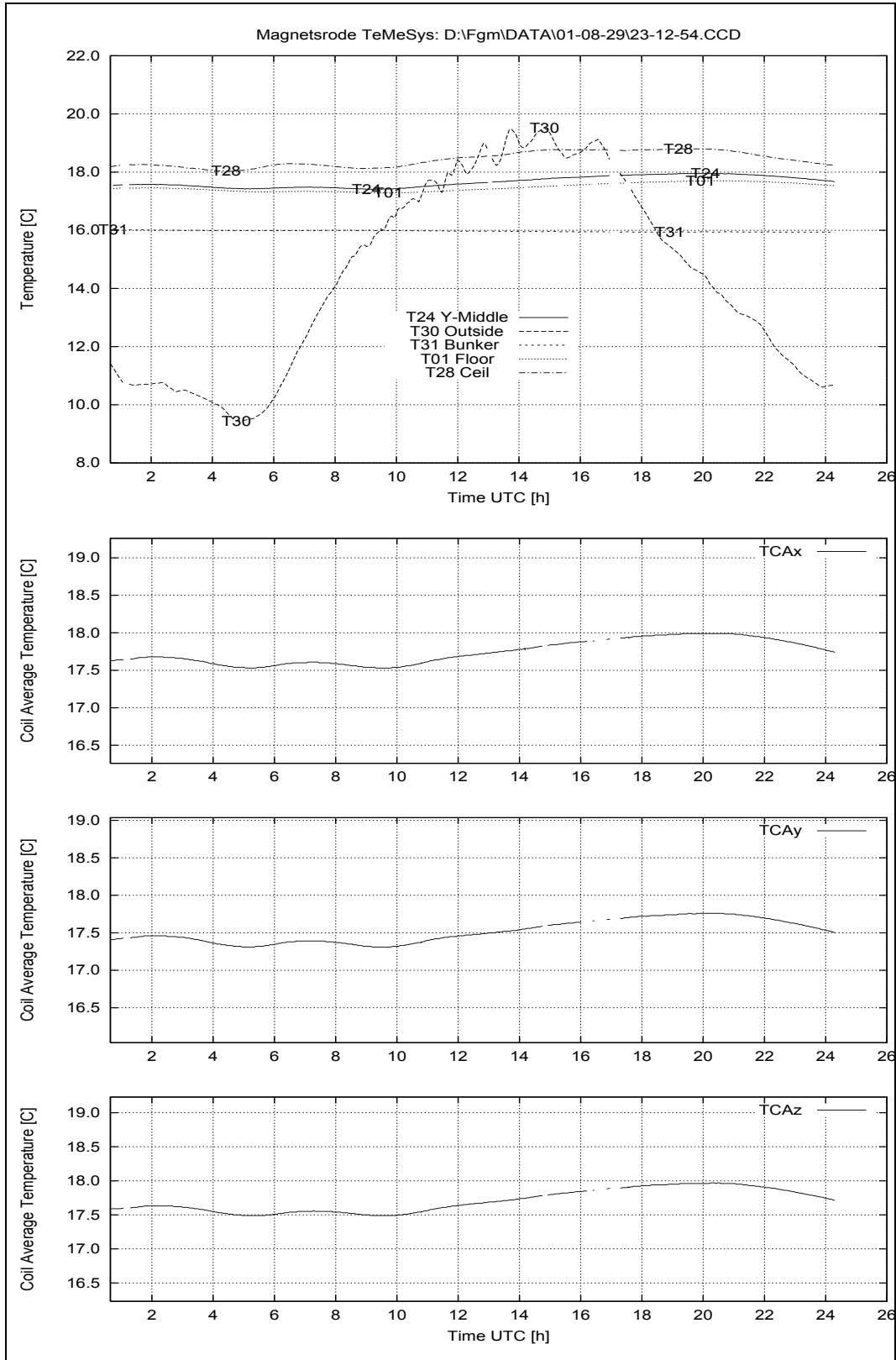

Figure 121: August 29, 2001: Temperatures House 2.

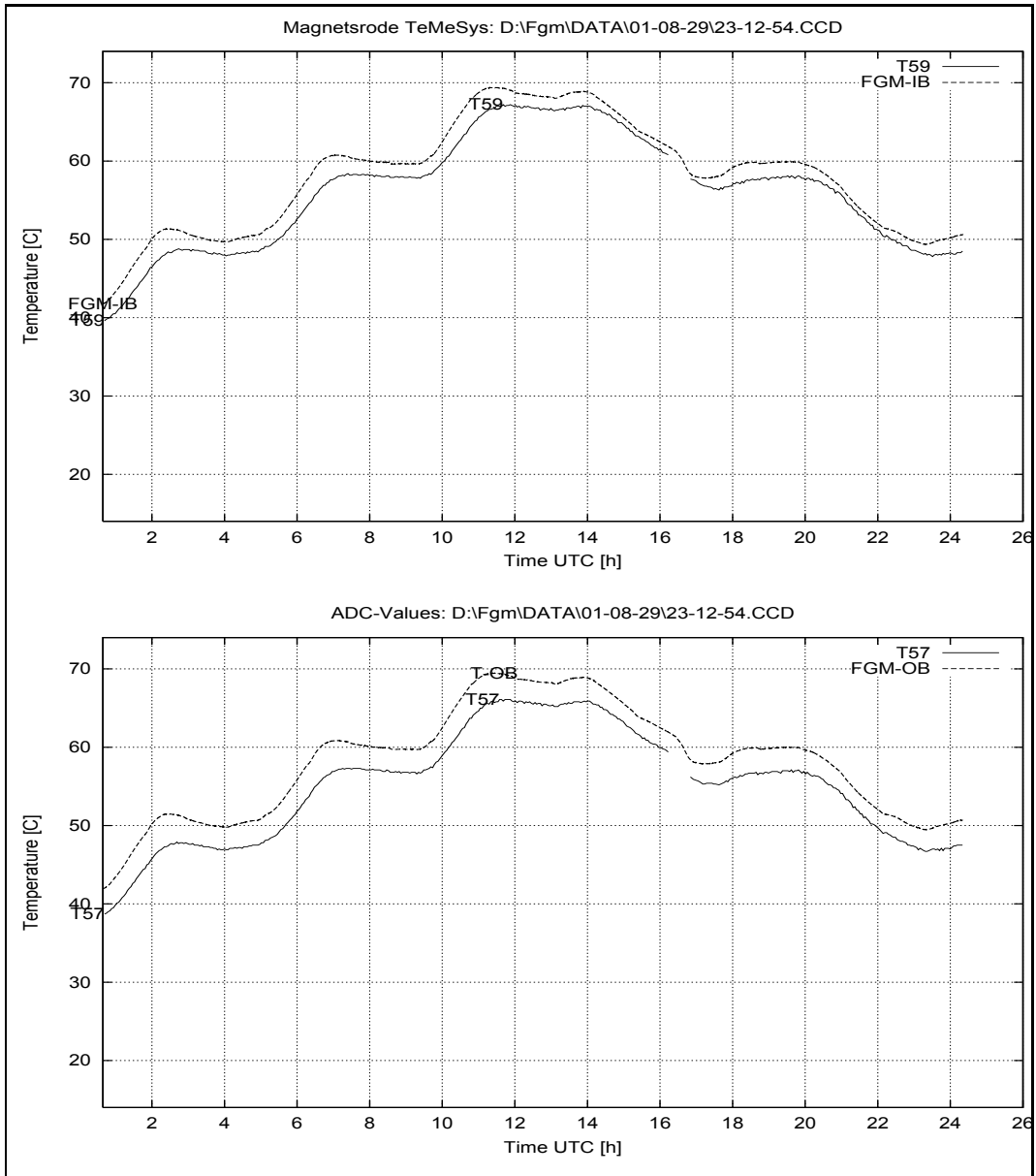

Figure 122: August 29, 2001: Sensor Temperatures at House 2.

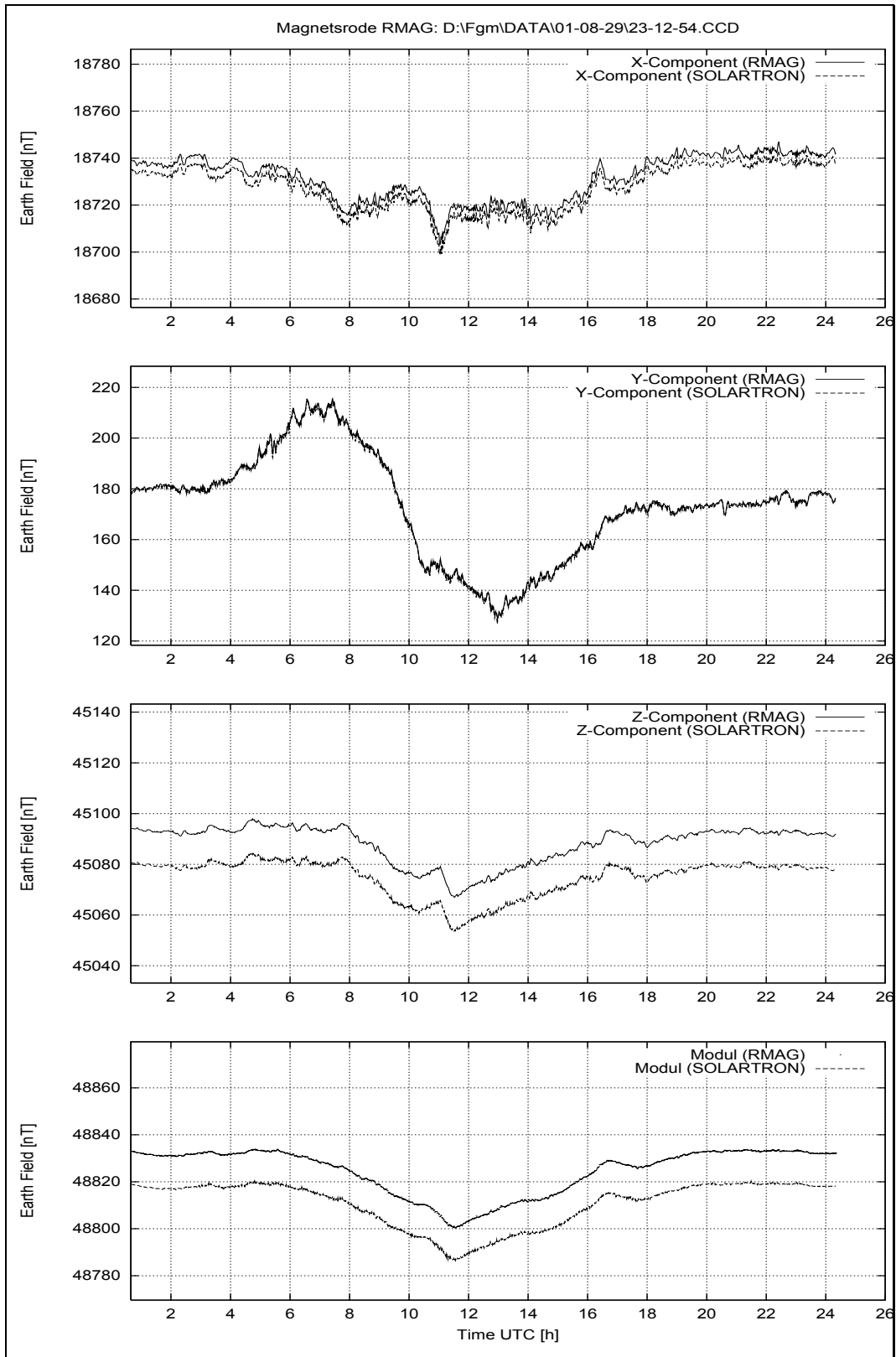

Figure 123: August 29, 2001: Earthfield variations.

R O S E T T A		Document: RO-IGM-TR-0002
		Issue: 2
		Revision: 2
IGM	Institut für Geophysik und Meteorologie	Date: October 10, 2001
	Technische Universität Braunschweig	Page: 185

30 Thursday August 30, 2001

30.1 Temperature Calibration, Heating Cycle continued, DPU:FS, Sensors: FS

The heating cycle continued until noon.

30.1.1 Data

Configuration File	CCD File	Remark
TEMP.CFG	01-08-30\00_20_56.CCD	
TEMP.CFG	01-08-30\01_28_37.CCD	
TEMP.CFG	01-08-30\02_36_18.CCD	
TEMP.CFG	01-08-30\03_43_59.CCD	
TEMP.CFG	01-08-30\04_51_40.CCD	
TEMP.CFG	01-08-30\05_59_22.CCD	
TEMP.CFG	01-08-30\07_07_03.CCD	
TEMP.CFG	01-08-30\08_14_45.CCD	
TEMP.CFG	01-08-30\09_22_26.CCD	
TEMP.CFG	01-08-30\10_30_07.CCD	
TEMP.CFG	01-08-30\11_37_48.CCD	

An inspection took place at 13:00. The system worked properly, the box temperature was at about 30°C.

Remark:

People from the METRONIX company were around from 08:40 – 11:05. Work was done in house 3 and should have not affected the calibration in house 2.

R O S E T T A	Document: RO-IGM-TR-0002
IGM	Issue: 2
	Revision: 2
	Date: October 10, 2001
	Page: 186
Institut für Geophysik und Meteorologie Technische Universität Braunschweig	

30.2 Temperature Calibration, Cooling Cycle, DPU:FS, Sensors: FS

Purpose: Measure the temperature behaviour of the FS sensors using the FS DPU.
Conditions: FS-OB and FS-IB placed in the Thermal Test Box on the aluminium support. The distance between them is 150 mm.
MAD: Ch0 to Ch2 connected to Zopfmag x to z, 10 nT/mV;
Ch7 FSP;
Timer 500, SumUp 100, Vectorrate 1.00 Hz.
Files: TEMP3.SEQ
Temperature
File: ROSETTA4.CUR
Tctrlparam. FLDtime: 40 s – TCctrl times: 24 s / 40s
Start: 30.08.01 13:01
End: 03.09.01 07:00 ESC.
Remark: Dry ice filling completed at 13:17.

30.2.1 Data

Configuration File	CCD File	Remark
TEMP.CFG	01-08-30\13_01_26.CCD	
TEMP.CFG	01-08-30\14_09_22.CCD	
TEMP.CFG	01-08-30\15_17_04.CCD	
TEMP.CFG	01-08-30\16_24_44.CCD	
TEMP.CFG	01-08-30\17_32_25.CCD	
TEMP.CFG	01-08-30\18_40_07.CCD	
TEMP.CFG	01-08-30\19_47_48.CCD	
TEMP.CFG	01-08-30\20_55_28.CCD	
TEMP.CFG	01-08-30\22_03_10.CCD	
TEMP.CFG	01-08-30\23_10_50.CCD	

30.3 Overview Plots: System Performance, Temperatures and Earth-field Variations.

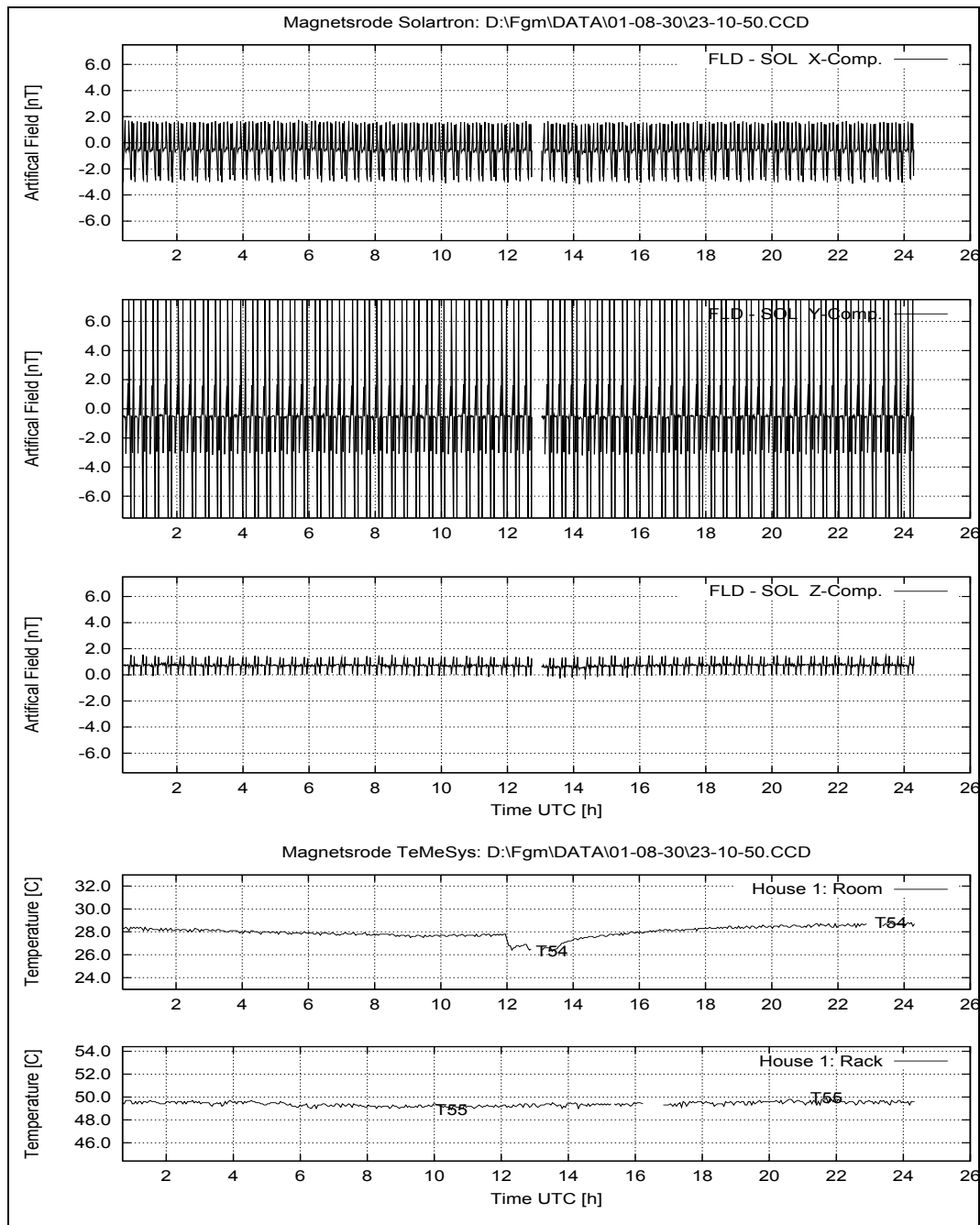

Figure 124: August 30, 2001: System Performance: FLD – SOL; Temperatures House 1.

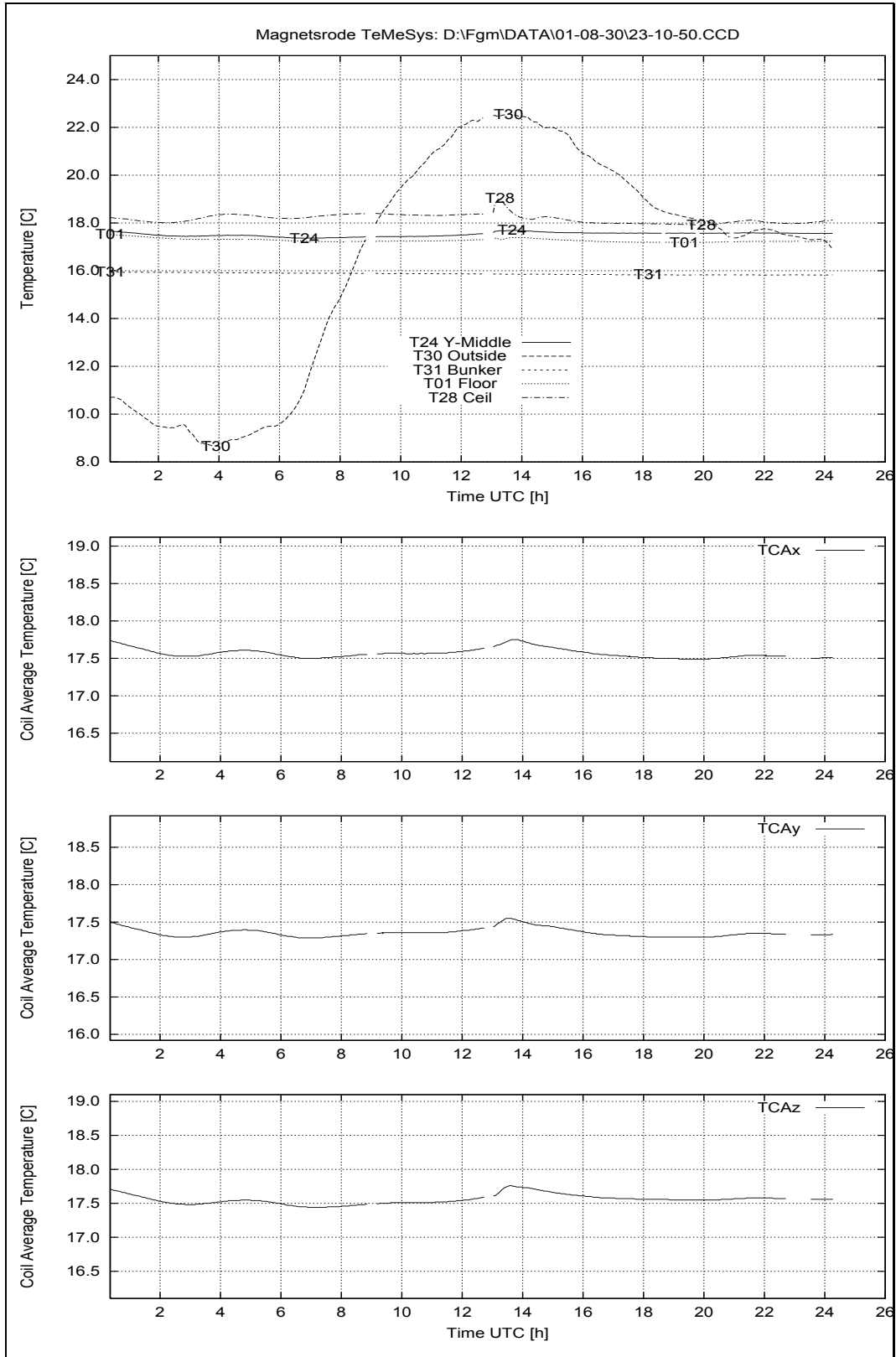

Figure 125: August 30, 2001: Temperatures House 2.

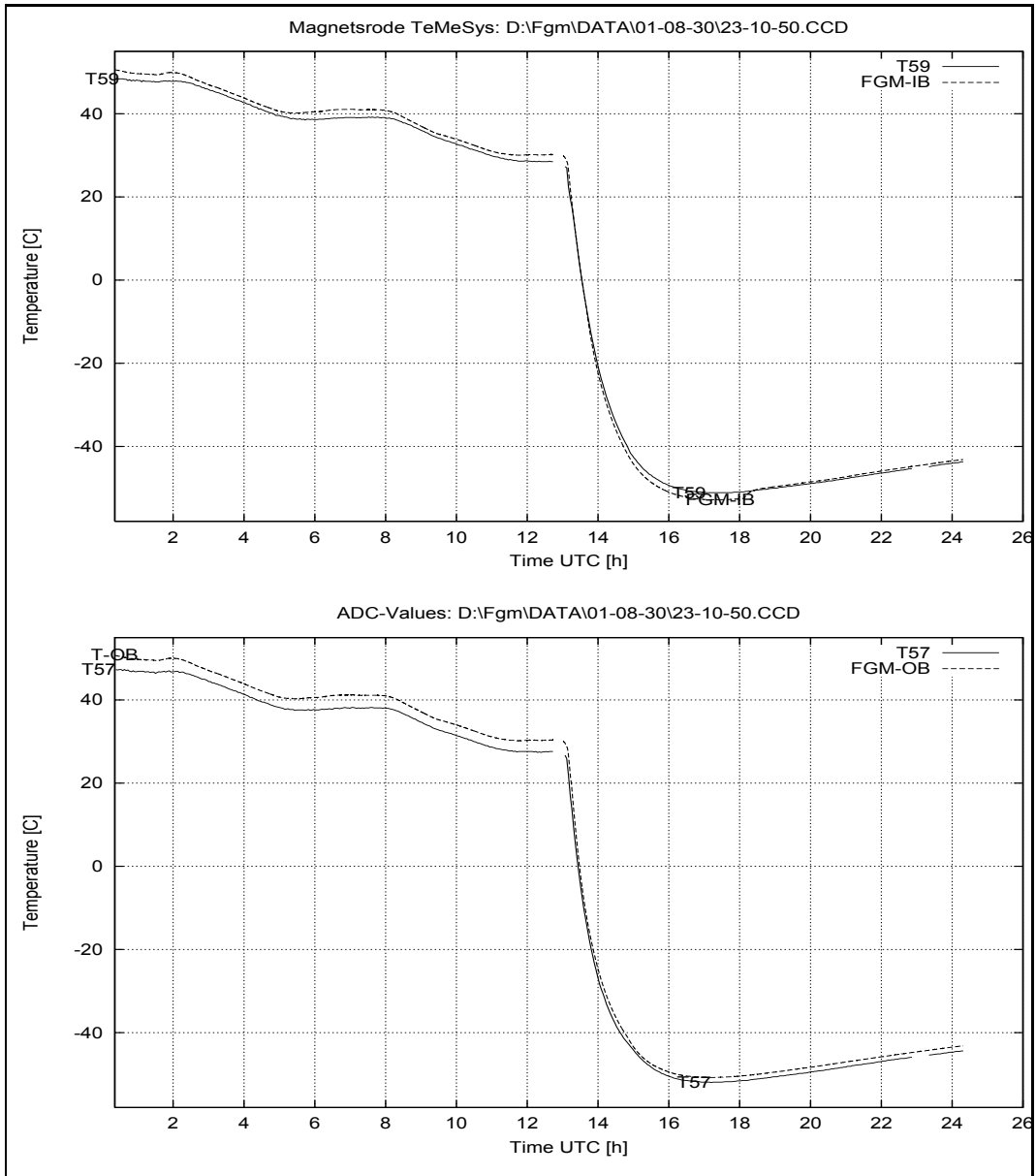

Figure 126: August 30, 2001: Sensor Temperatures at House 2.

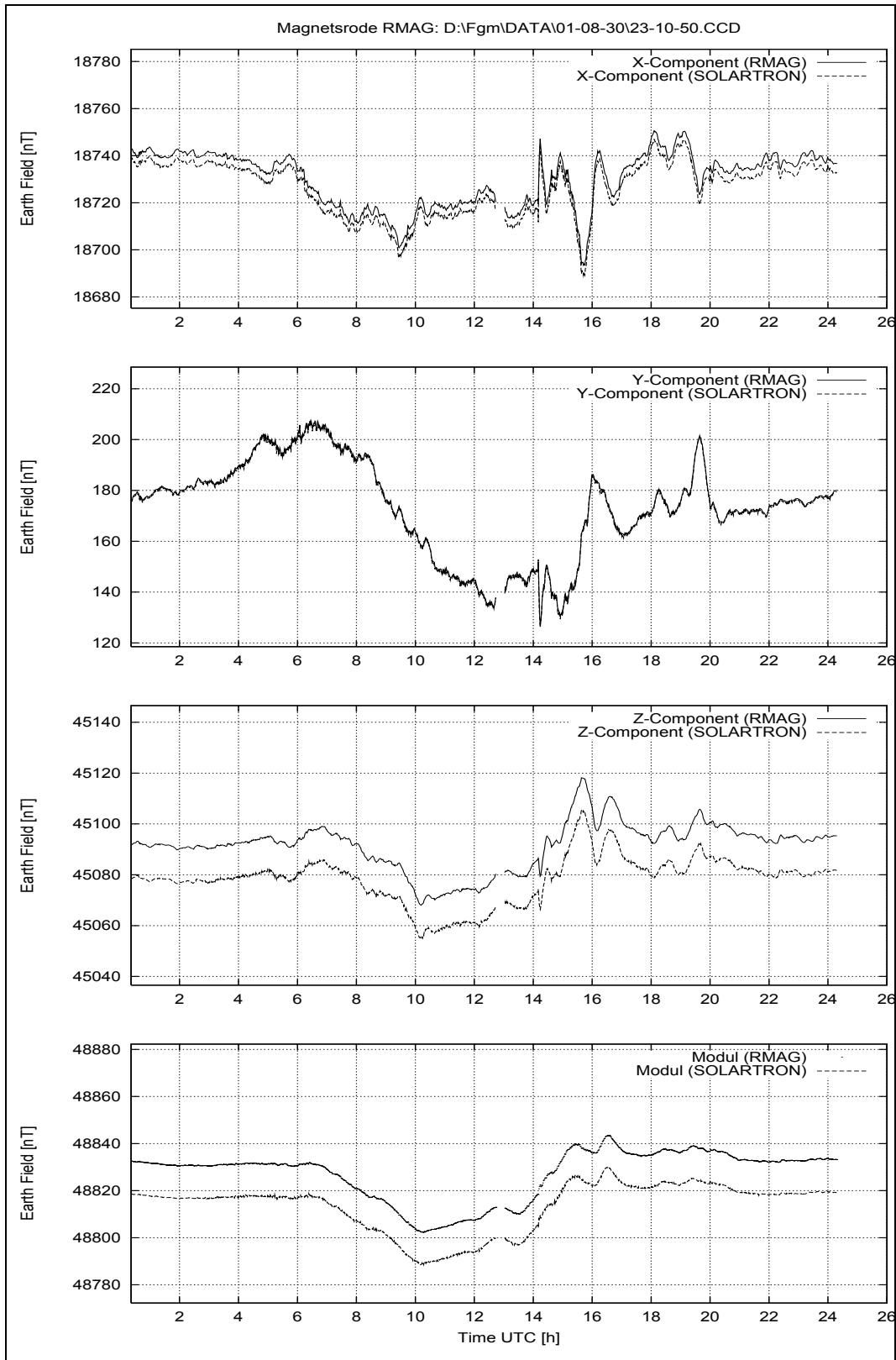

Figure 127: August 30, 2001: Earthfield variations.

R O S E T T A		Document: RO-IGM-TR-0002
		Issue: 2
		Revision: 2
IGM	Institut für Geophysik und Meteorologie	Date: October 10, 2001
	Technische Universität Braunschweig	Page: 191

31 Friday August 31, 2001

31.1 Temperature Calibration, Cooling Cycle continued, DPU:FS, Sensors: FS

The cooling cycle continued today without any personal support.

31.1.1 Data

Configuration File	CCD File	Remark
TEMP.CFG	01-08-31\00_18_53.CCD	
TEMP.CFG	01-08-31\01_26_33.CCD	
TEMP.CFG	01-08-31\02_34_12.CCD	
TEMP.CFG	01-08-31\03_41_53.CCD	
TEMP.CFG	01-08-31\04_49_33.CCD	
TEMP.CFG	01-08-31\05_57_13.CCD	
TEMP.CFG	01-08-31\07_05_48.CCD	
TEMP.CFG	01-08-31\08_13_29.CCD	
TEMP.CFG	01-08-31\09_21_09.CCD	
TEMP.CFG	01-08-31\10_28_49.CCD	
TEMP.CFG	01-08-31\11_36_29.CCD	
TEMP.CFG	01-08-31\12_44_09.CCD	
TEMP.CFG	01-08-31\13_52_07.CCD	
TEMP.CFG	01-08-31\14_59_47.CCD	
TEMP.CFG	01-08-31\16_07_27.CCD	
TEMP.CFG	01-08-31\17_15_08.CCD	
TEMP.CFG	01-08-31\18_22_47.CCD	
TEMP.CFG	01-08-31\19_30_28.CCD	
TEMP.CFG	01-08-31\20_38_08.CCD	
TEMP.CFG	01-08-31\21_45_49.CCD	
TEMP.CFG	01-08-31\22_53_29.CCD	

31.2 Overview Plots: System Performance, Temperatures and Earth-field Variations.

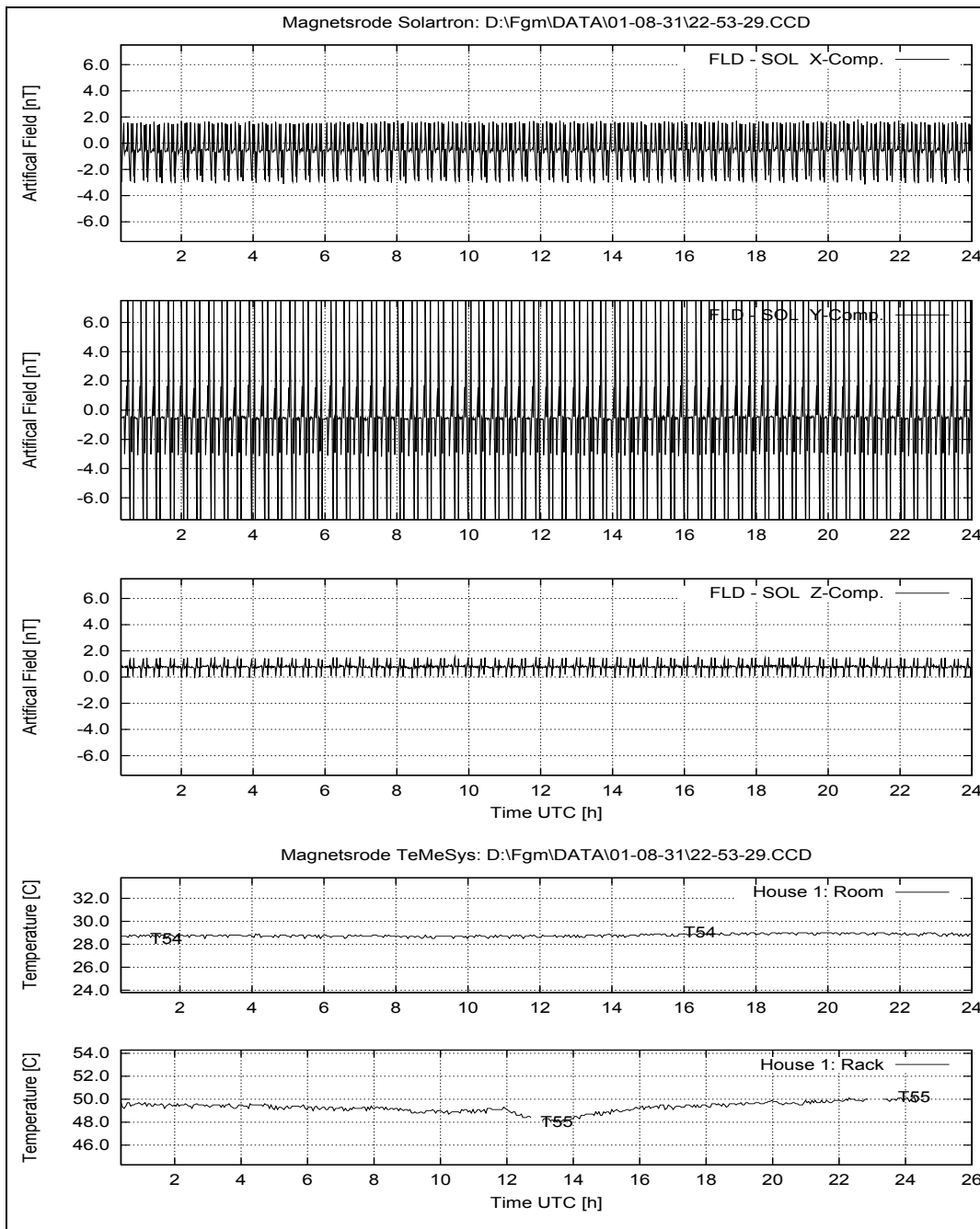

Figure 128: August 31, 2001: System Performance: FLD – SOL; Temperatures House 1.

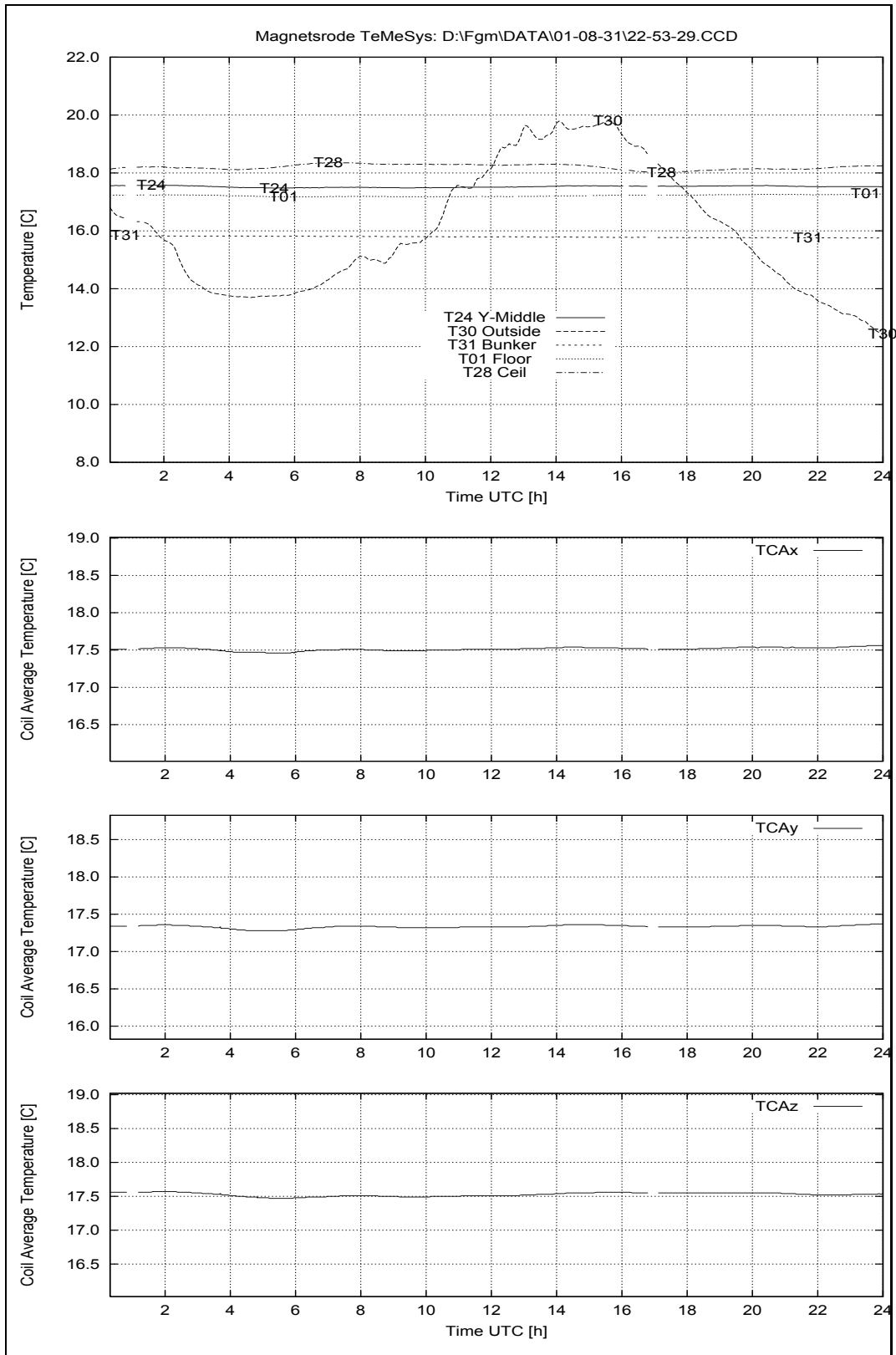

Figure 129: August 31, 2001: Temperatures House 2.

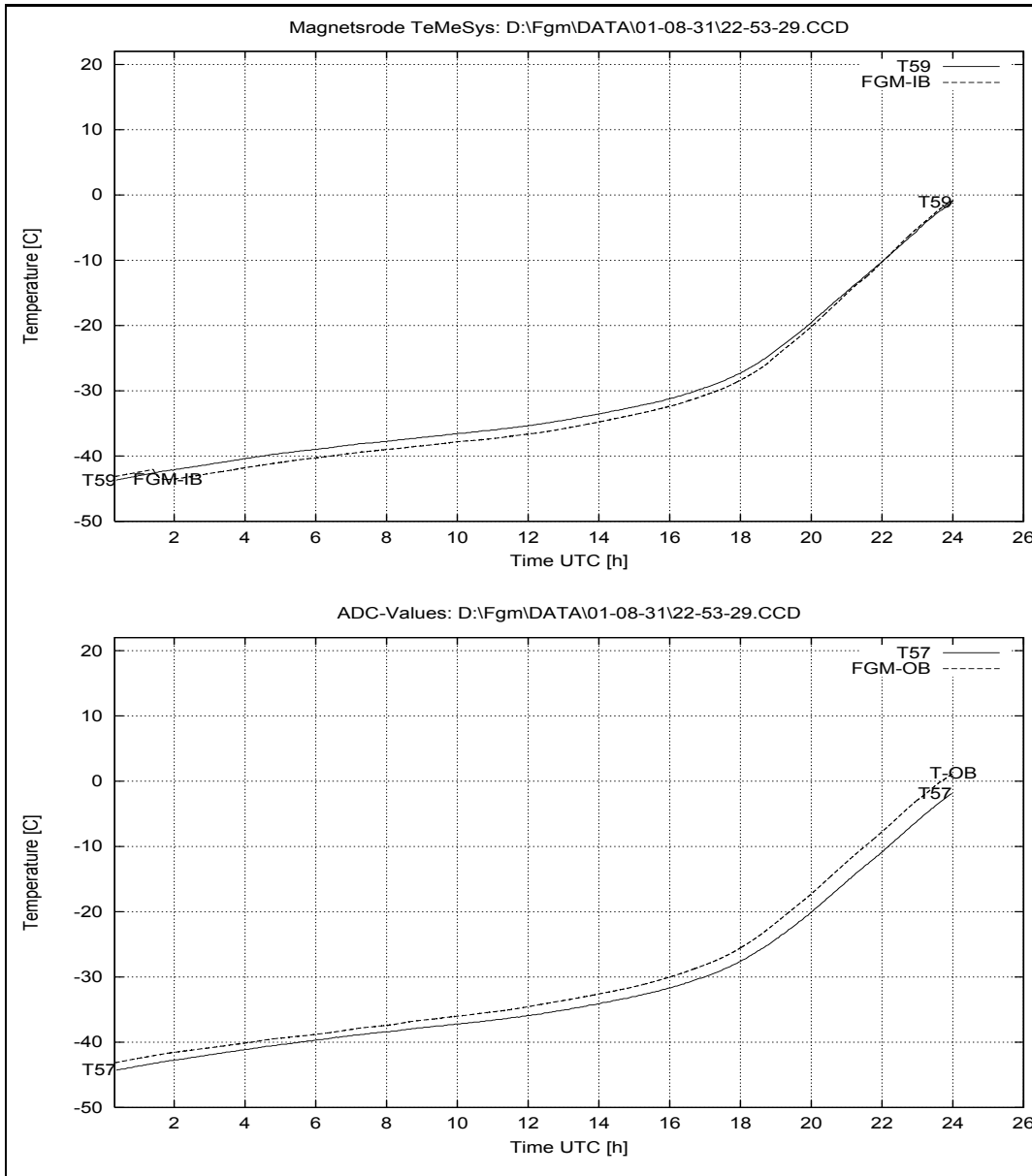

Figure 130: August 31, 2001: Sensor Temperatures at House 2.

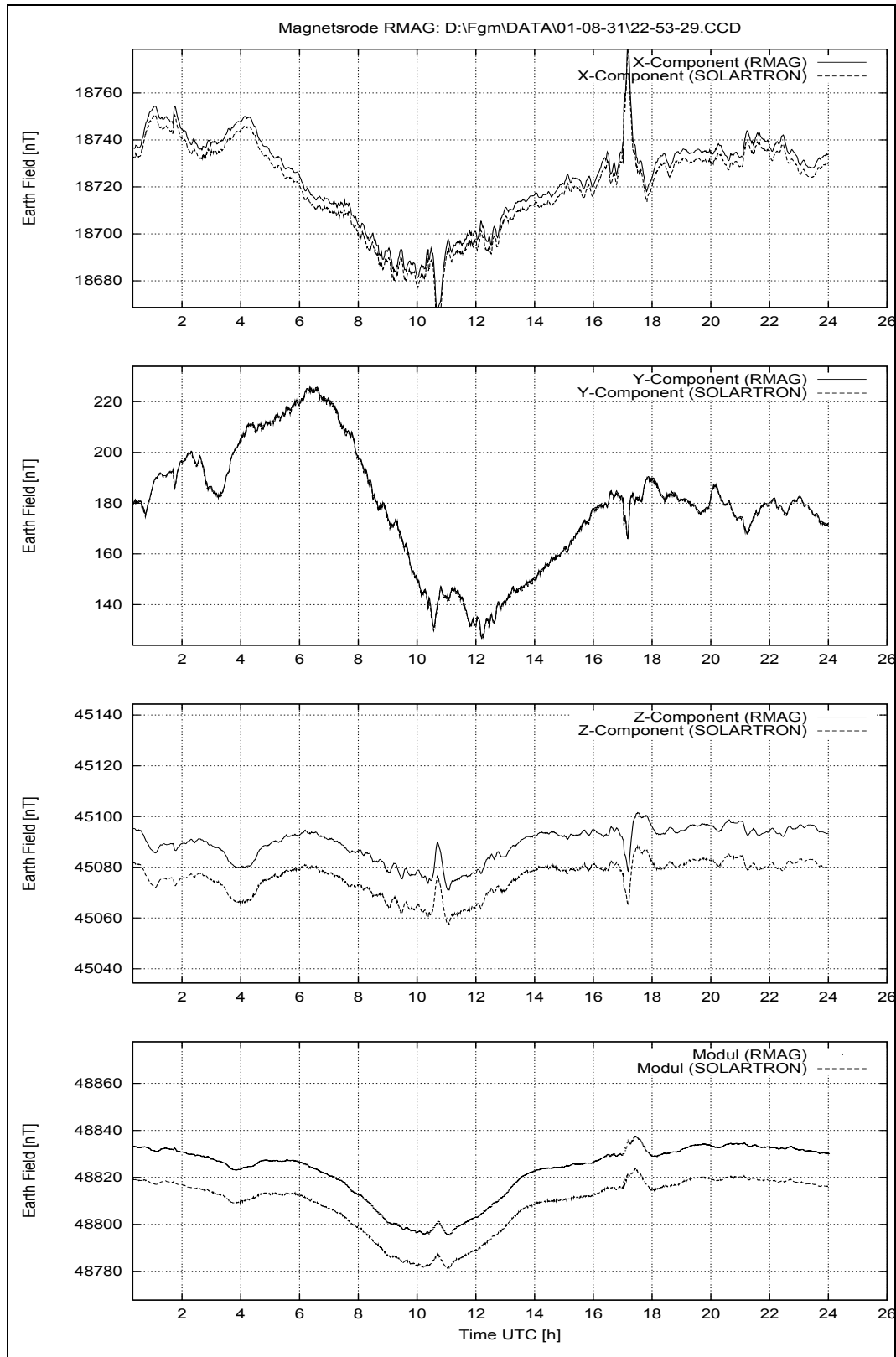

Figure 131: August 31, 2001: Earthfield variations.

R O S E T T A	Document: RO-IGM-TR-0002
IGM	Issue: 2
	Revision: 2
	Date: October 10, 2001
Institut für Geophysik und Meteorologie Technische Universität Braunschweig	Page: 196

32 Saturday September 1, 2001

32.1 Temperature Calibration, Cooling Cycle continued, DPU:FS, Sensors: FS

The cooling cycle continued today without any personal support.

32.1.1 Data

Configuration File	CCD File	Remark
TEMP.CFG	01-09-01\00_01_10.CCD	
TEMP.CFG	01-09-01\01_08_50.CCD	
TEMP.CFG	01-09-01\02_16_31.CCD	
TEMP.CFG	01-09-01\03_24_11.CCD	
TEMP.CFG	01-09-01\04_31_52.CCD	
TEMP.CFG	01-09-01\05_39_32.CCD	
TEMP.CFG	01-09-01\06_47_12.CCD	
TEMP.CFG	01-09-01\07_54_52.CCD	
TEMP.CFG	01-09-01\09_02_33.CCD	
TEMP.CFG	01-09-01\10_10_14.CCD	
TEMP.CFG	01-09-01\11_17_54.CCD	
TEMP.CFG	01-09-01\12_25_35.CCD	
TEMP.CFG	01-09-01\13_33_16.CCD	
TEMP.CFG	01-09-01\14_40_56.CCD	
TEMP.CFG	01-09-01\15_48_37.CCD	
TEMP.CFG	01-09-01\16_56_17.CCD	
TEMP.CFG	01-09-01\18_03_58.CCD	
TEMP.CFG	01-09-01\19_11_38.CCD	
TEMP.CFG	01-09-01\20_19_19.CCD	
TEMP.CFG	01-09-01\21_26_59.CCD	
TEMP.CFG	01-09-01\22_34_40.CCD	
TEMP.CFG	01-09-01\23_42_21.CCD	

32.2 Overview Plots: System Performance, Temperatures and Earth-field Variations.

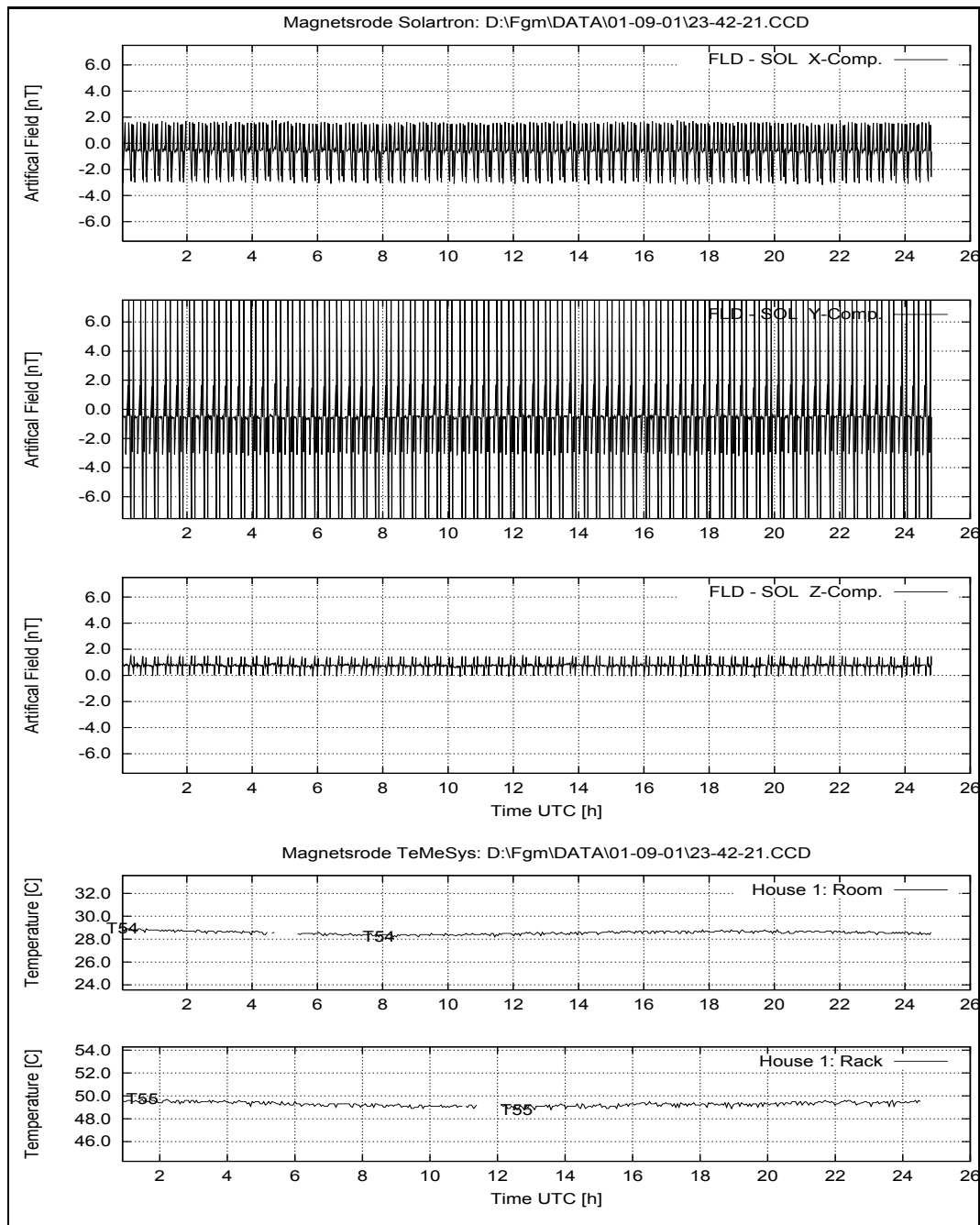

Figure 132: September 1, 2001: System Performance: FLD – SOL; Temperatures House 1.

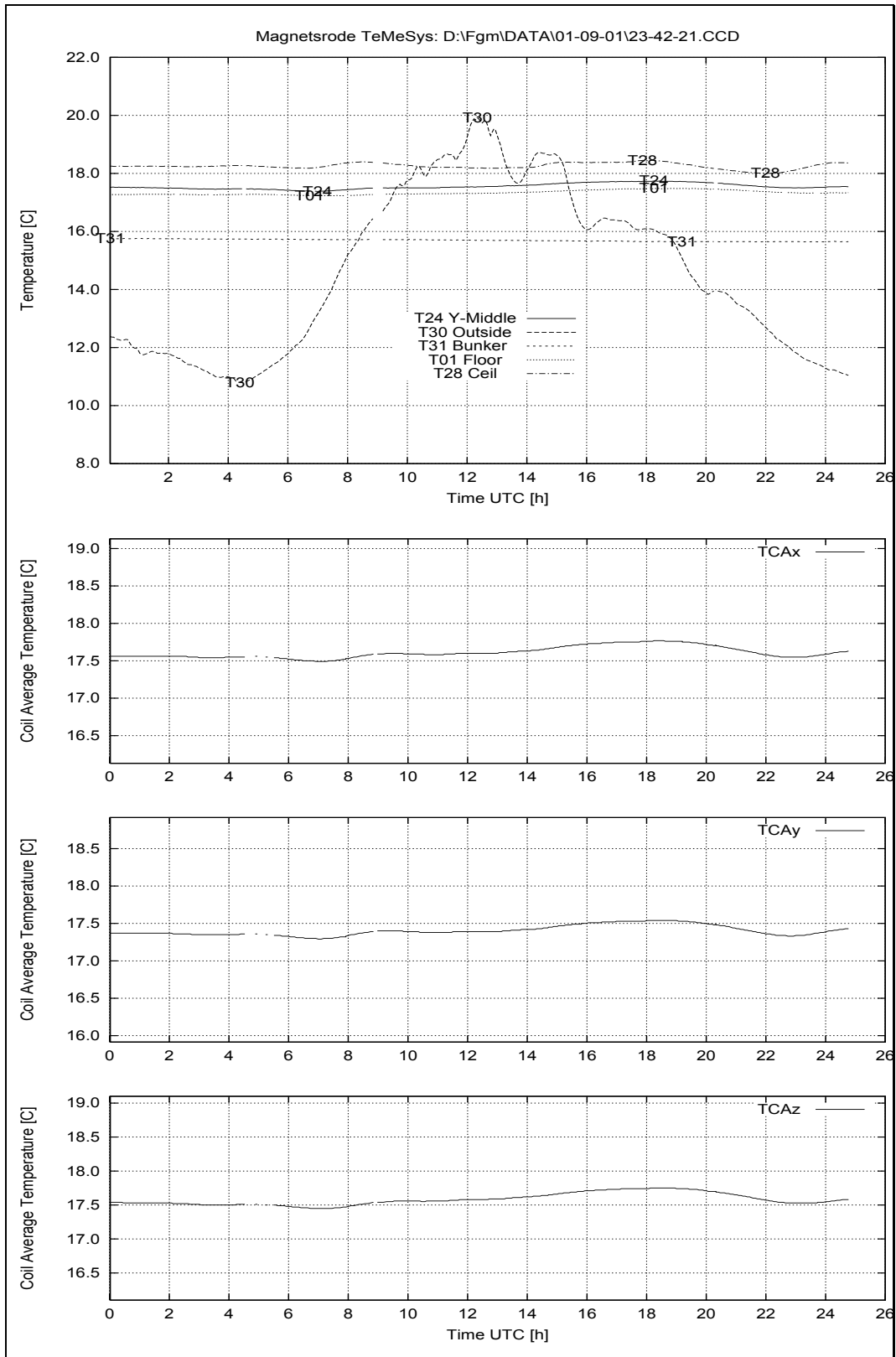

Figure 133: September 1, 2001: Temperatures House 2.

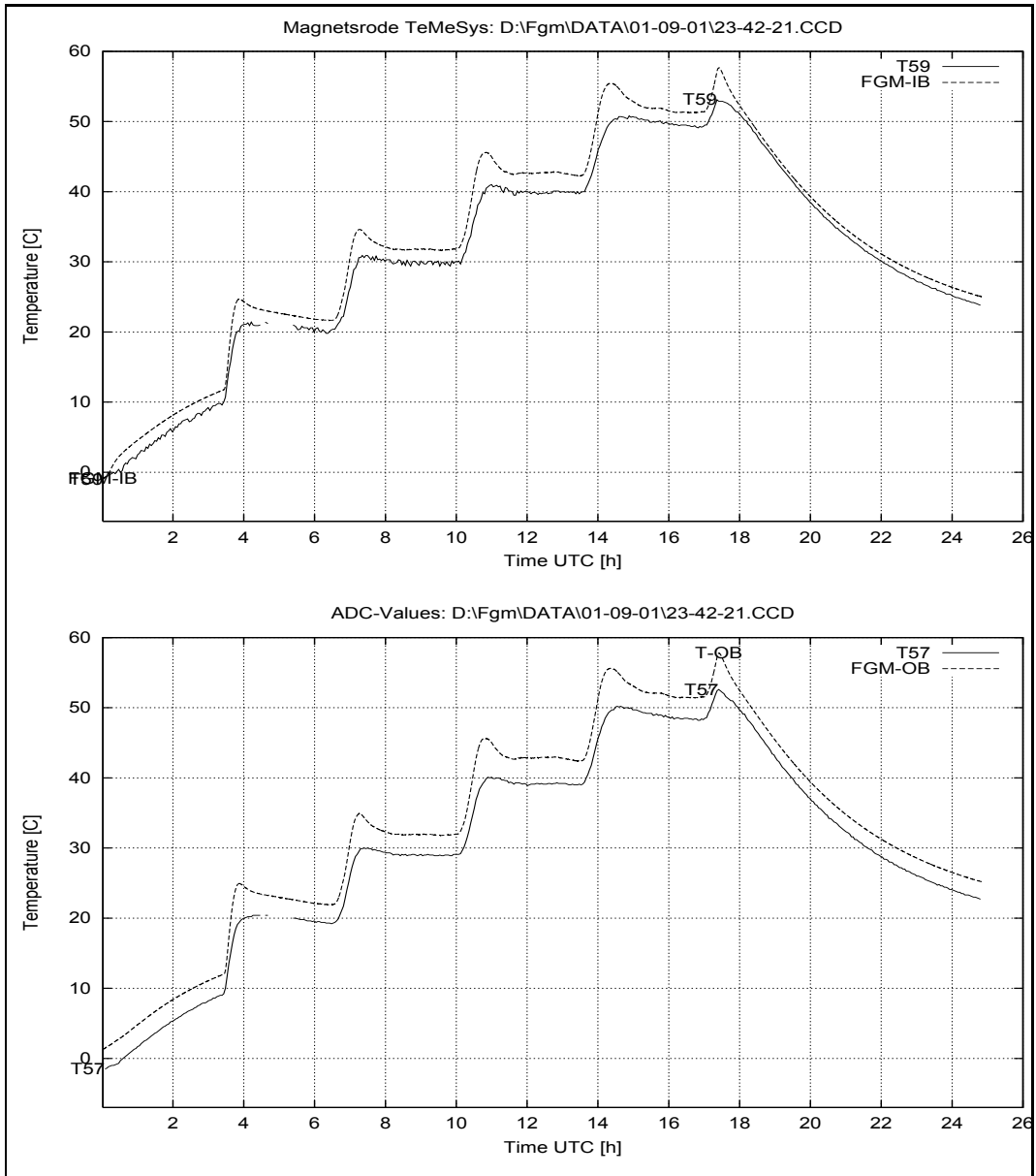

Figure 134: September 1, 2001: Sensor Temperatures at House 2.

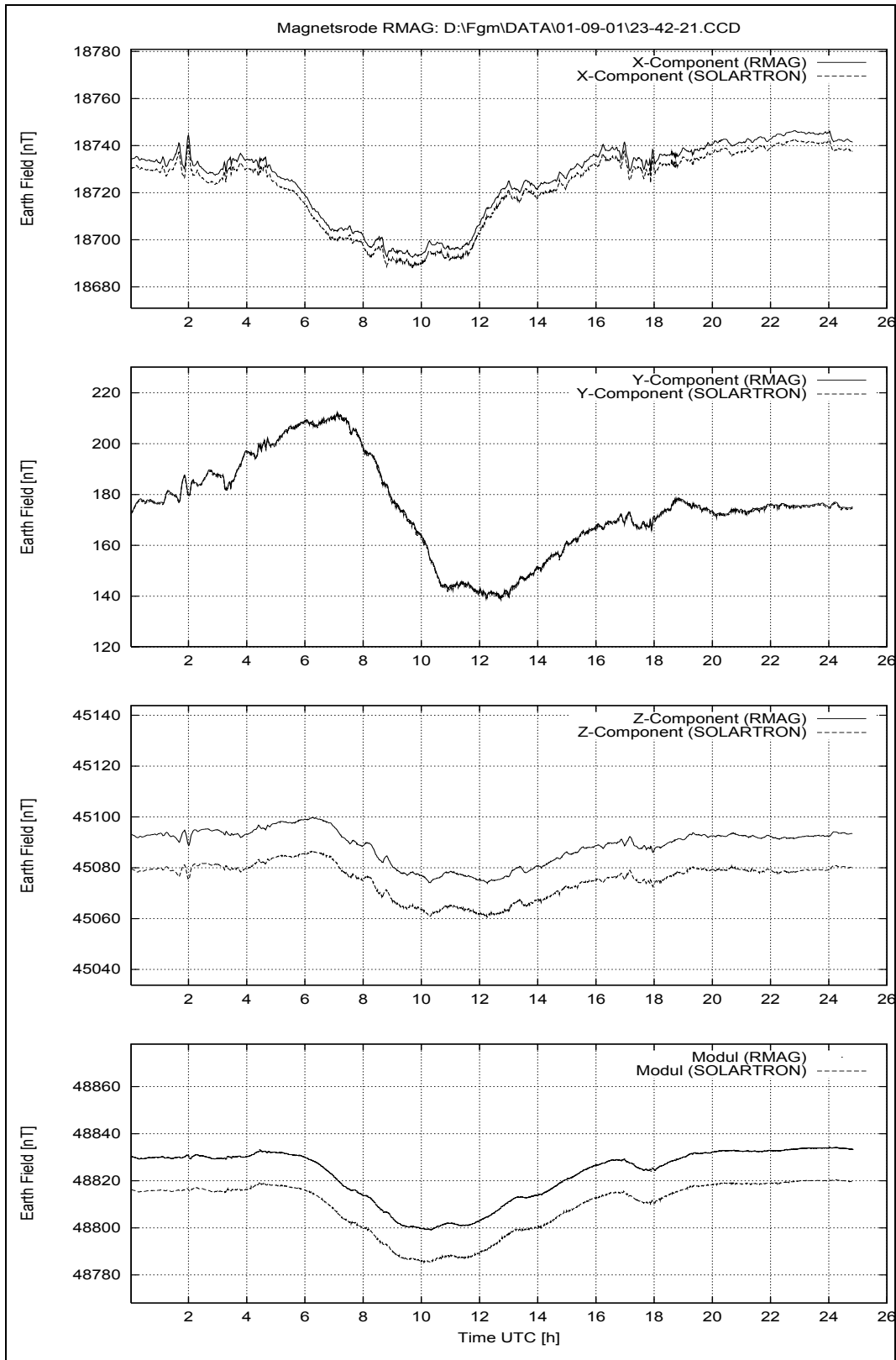

Figure 135: September 1, 2001: Earthfield variations.

R O S E T T A		Document: RO-IGM-TR-0002
IGM Institut für Geophysik und Meteorologie Technische Universität Braunschweig		Issue: 2
		Revision: 2
		Date: October 10, 2001
		Page: 201

33 Sunday September 2, 2001

33.1 Temperature Calibration, Cooling Cycle continued, DPU:FS, Sensors: FS

The cooling cycle continued today without any personal support.

33.1.1 Data

Configuration File	CCD File	Remark
TEMP.CFG	01-09-02\00_50_02.CCD	
TEMP.CFG	01-09-02\01_58_11.CCD	
TEMP.CFG	01-09-02\03_05_50.CCD	
TEMP.CFG	01-09-02\04_13_30.CCD	
TEMP.CFG	01-09-02\05_21_11.CCD	
TEMP.CFG	01-09-02\06_28_52.CCD	
TEMP.CFG	01-09-02\07_36_34.CCD	
TEMP.CFG	01-09-02\08_44_13.CCD	
TEMP.CFG	01-09-02\09_51_54.CCD	
TEMP.CFG	01-09-02\10_59_34.CCD	
TEMP.CFG	01-09-02\12_07_15.CCD	
TEMP.CFG	01-09-02\13_15_06.CCD	
TEMP.CFG	01-09-02\14_22_47.CCD	
TEMP.CFG	01-09-02\15_30_28.CCD	
TEMP.CFG	01-09-02\16_38_08.CCD	
TEMP.CFG	01-09-02\17_45_50.CCD	
TEMP.CFG	01-09-02\18_53_30.CCD	
TEMP.CFG	01-09-02\20_01_10.CCD	
TEMP.CFG	01-09-02\21_08_51.CCD	
TEMP.CFG	01-09-02\22_16_32.CCD	
TEMP.CFG	01-09-02\23_24_12.CCD	

33.2 Overview Plots: System Performance, Temperatures and Earth-field Variations.

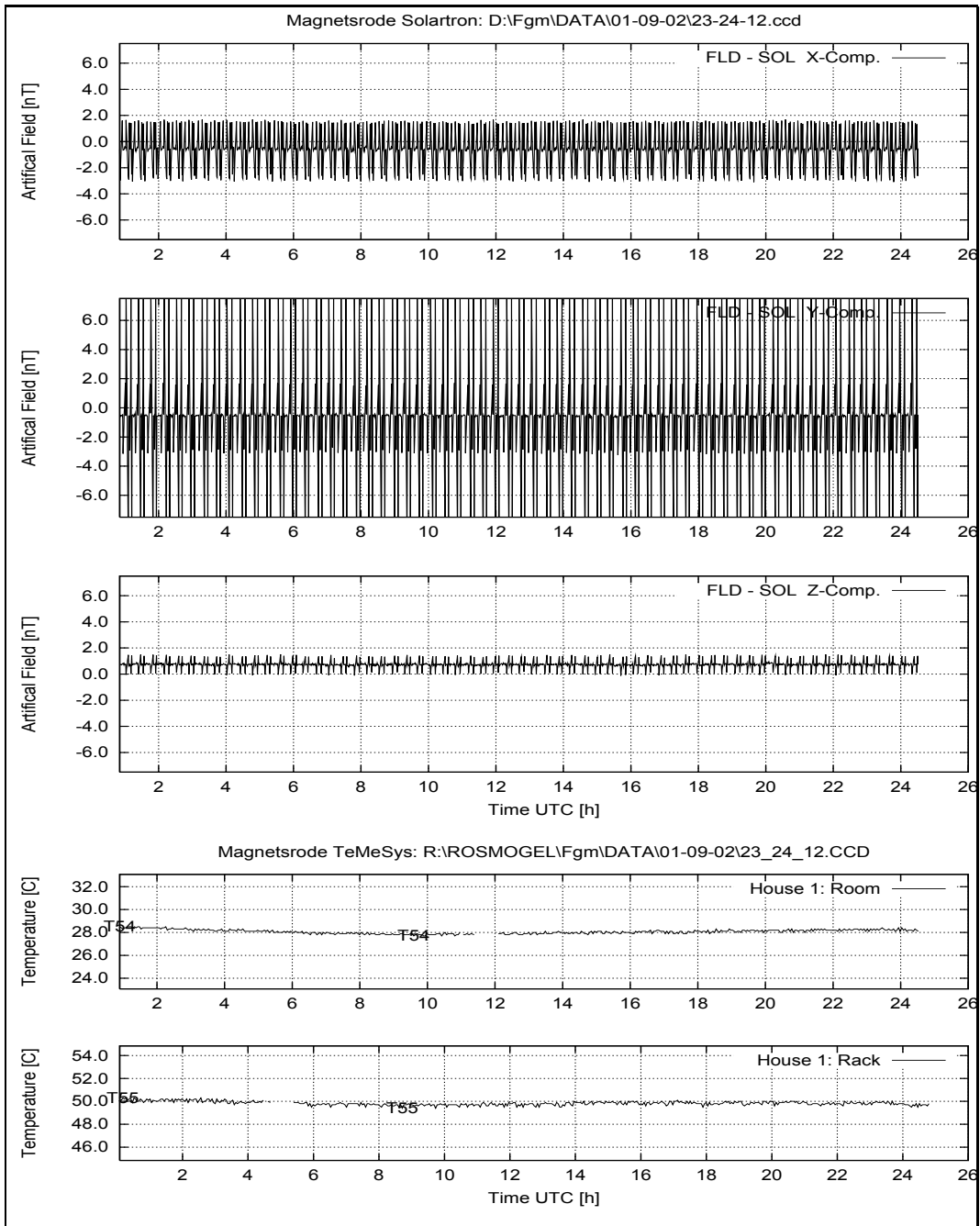

Figure 136: September 2, 2001: System Performance: FLD – SOL; Temperatures House 1.

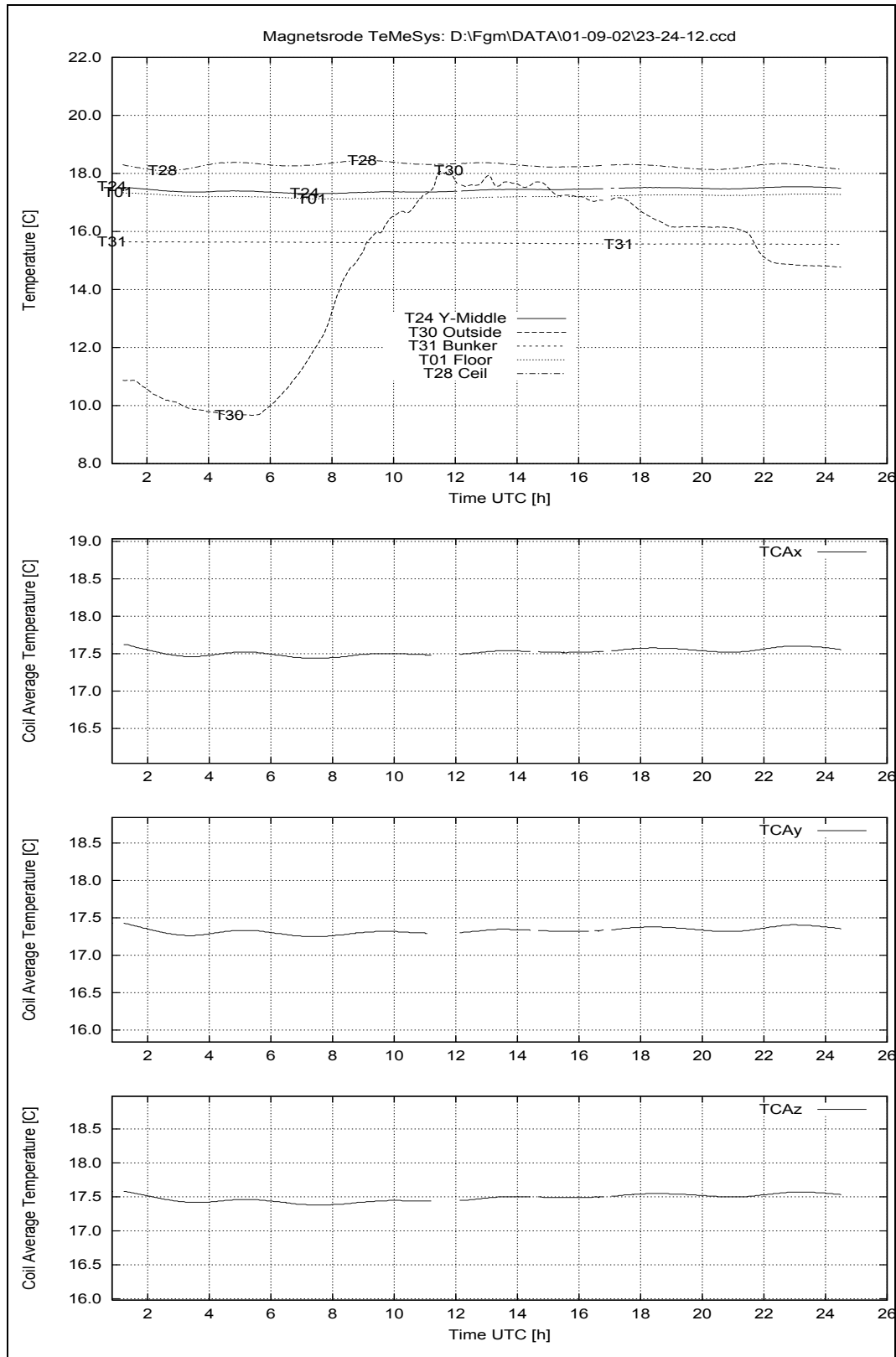

Figure 137: September 2, 2001: Temperatures House 2.

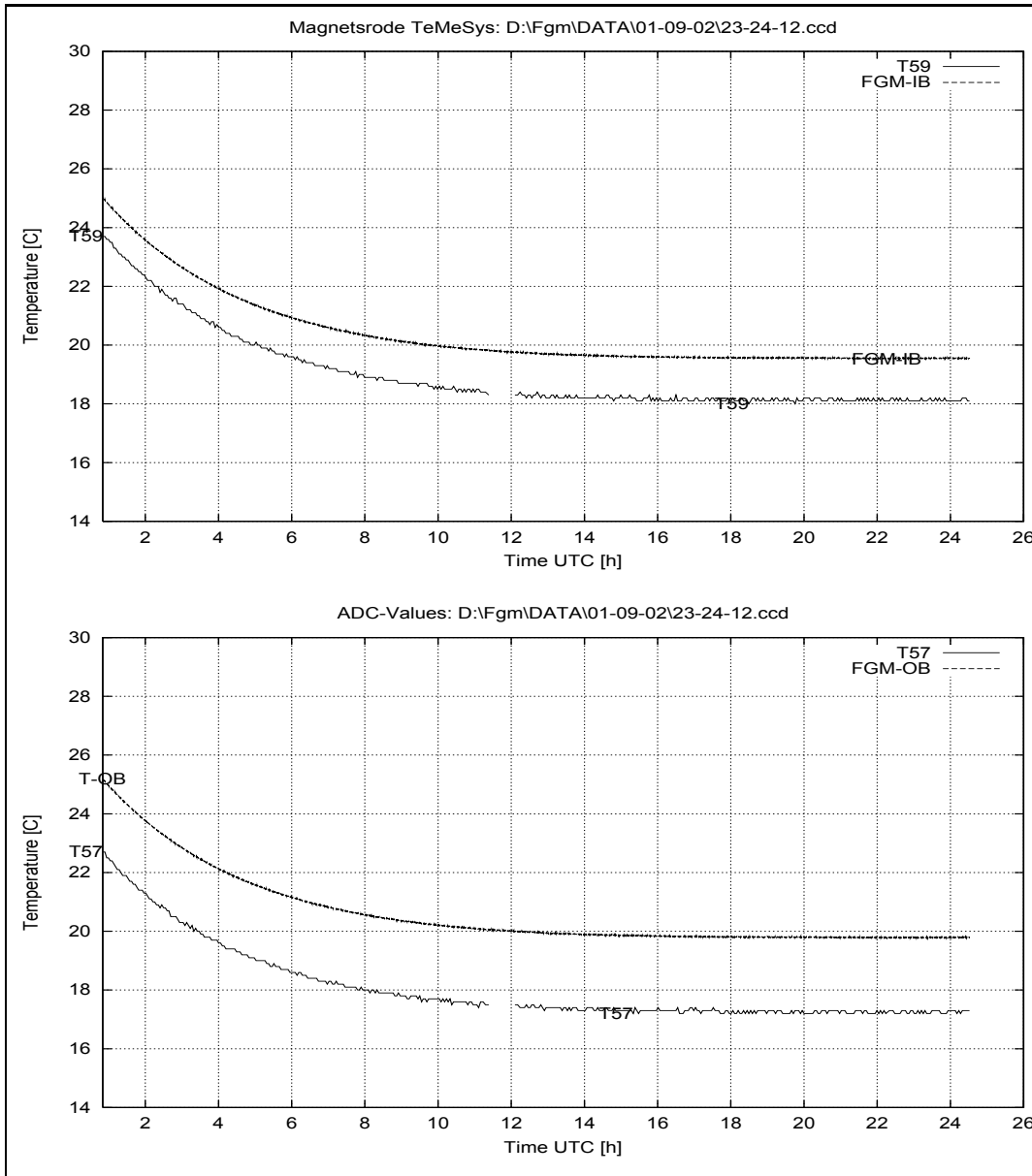

Figure 138: September 2, 2001: Sensor Temperatures at House 2.

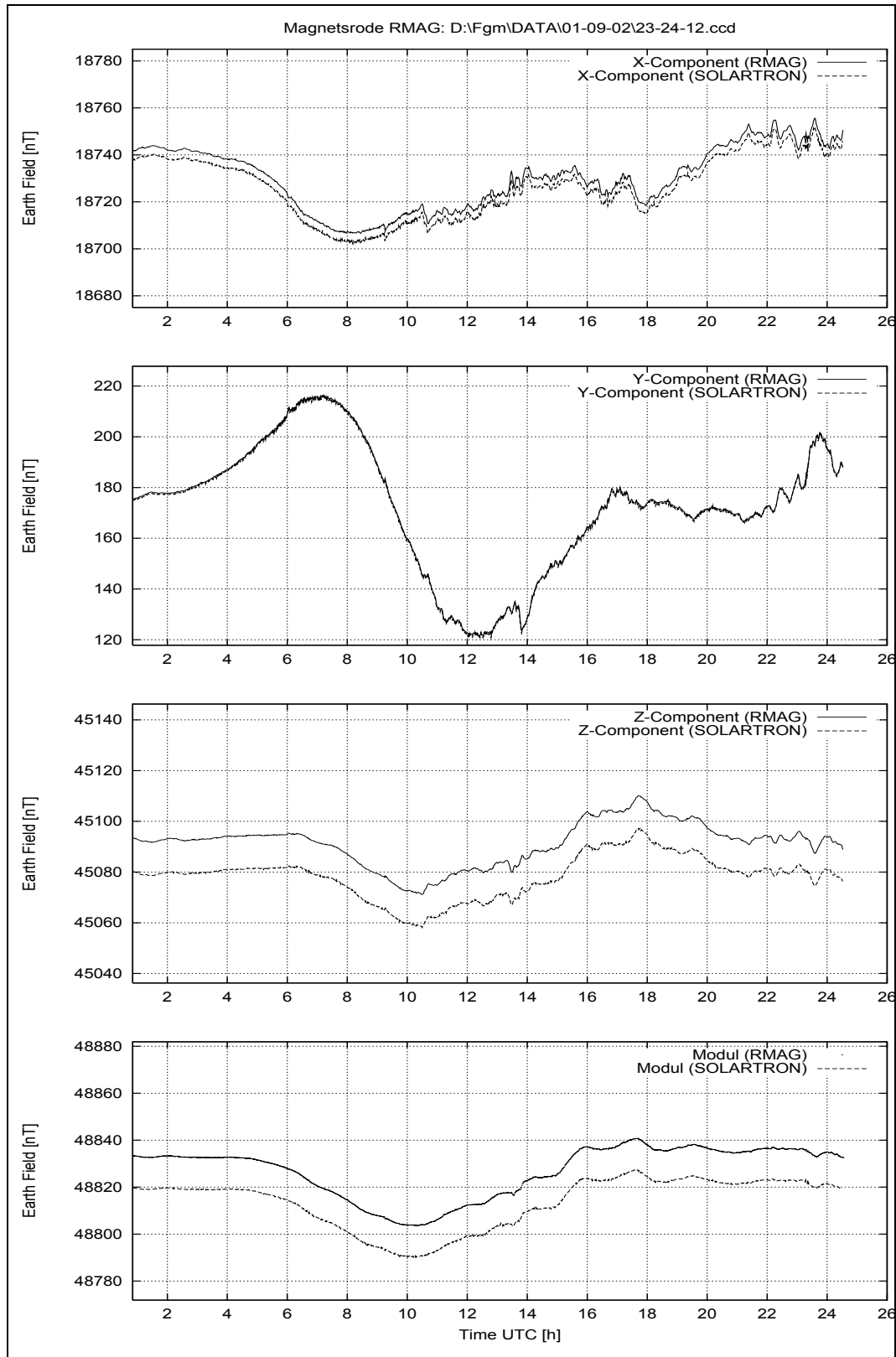

Figure 139: September 2, 2001: Earthfield variations.

R O S E T T A		Document: RO-IGM-TR-0002
		Issue: 2
		Revision: 2
IGM	Institut für Geophysik und Meteorologie	Date: October 10, 2001
	Technische Universität Braunschweig	Page: 206

34 Monday September 3, 2001

34.1 Temperature Calibration, Cooling Cycle continued, DPU:FS, Sensors: FS

The cooling cycle continued today until the morning hours. The system was inspected at 07:00. The box temperature was at 18°C. The check of the TempCtrl electronics box revealed an error at the 'OK' LED. It was dark. Therefore, the calibration was interrupted manually at file #80. An in depth analysis showed up that the main fuse of the TempCtrl electronics box was melted. The failure occurred at 01-09-01/ 17:20. This was most likely caused by the very steep temperature profile curve. The needed power could probably not be provided. May be this failure was just an effect of the old fuse, which has been used for some years. The fuse was exchanged, and the system worked properly again.

As the failure occurred at about 50 °C it was decided to take just the already measured data and not to start another new run on these sensors.

After after a break of two days, the calibration of the FM sensors started.

34.1.1 Data

Configuration File	CCD File	Remark
TEMP.CFG	01-09-03\00_31_53.CCD	
TEMP.CFG	01-09-03\01_39_34.CCD	
TEMP.CFG	01-09-03\02_47_15.CCD	
TEMP.CFG	01-09-03\03_54_56.CCD	
TEMP.CFG	01-09-03\05_02_36.CCD	
TEMP.CFG	01-09-03\06_10_17.CCD	

34.2 Overview Plots: System Performance, Temperatures and Earth-field Variations.

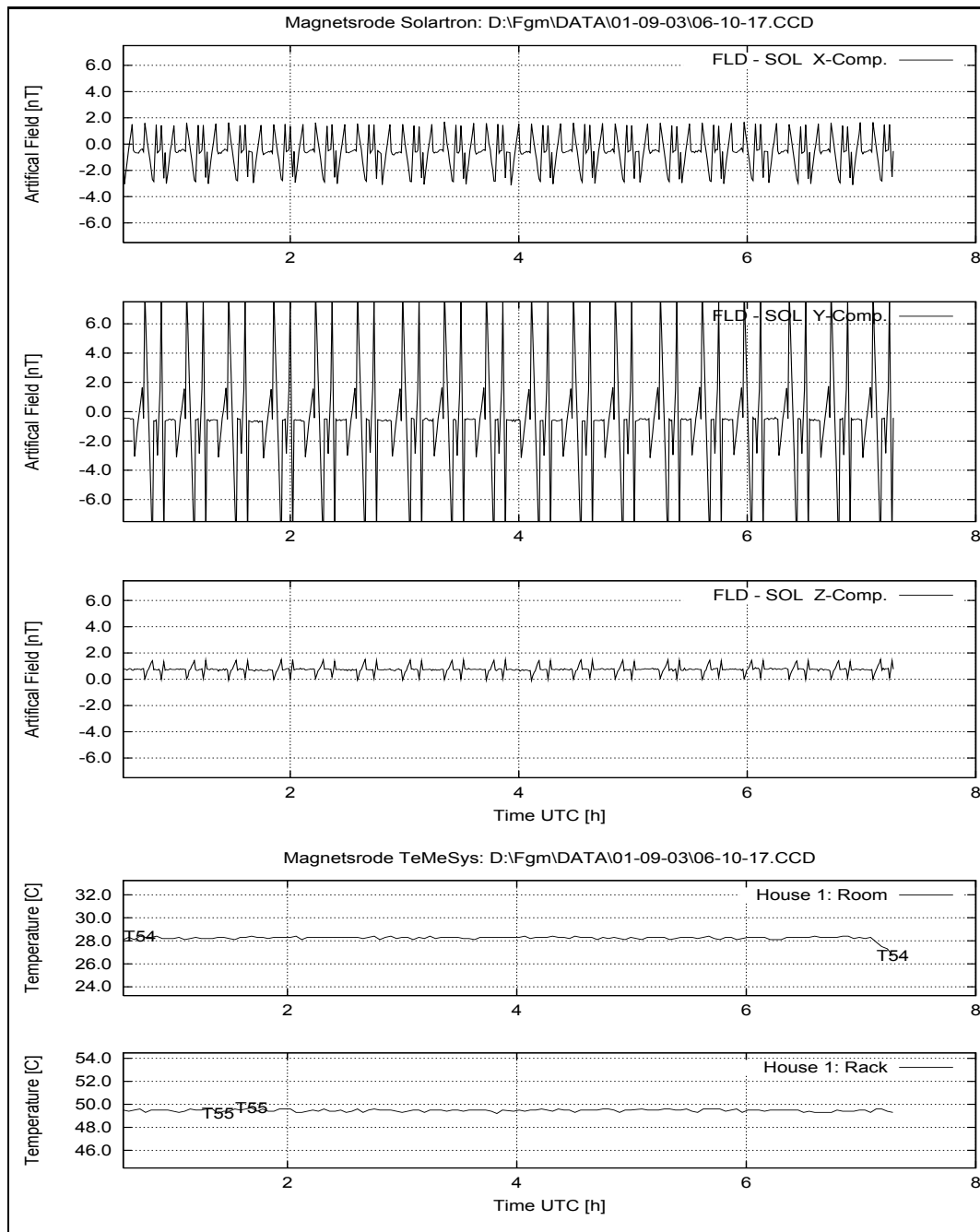

Figure 140: September 3, 2001: System Performance: FLD – SOL; Temperatures House 1.

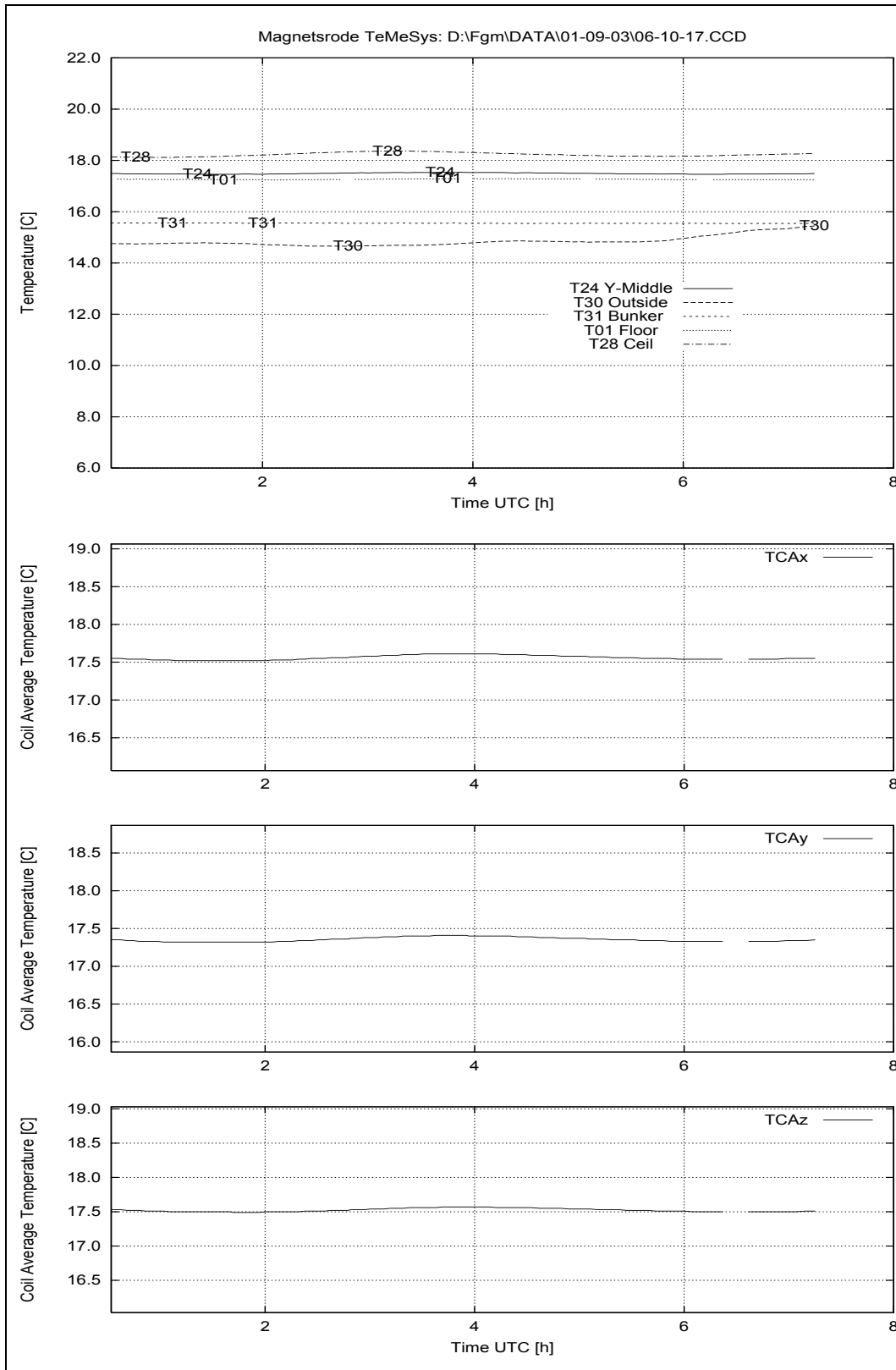

Figure 141: September 3, 2001: Temperatures House 2.

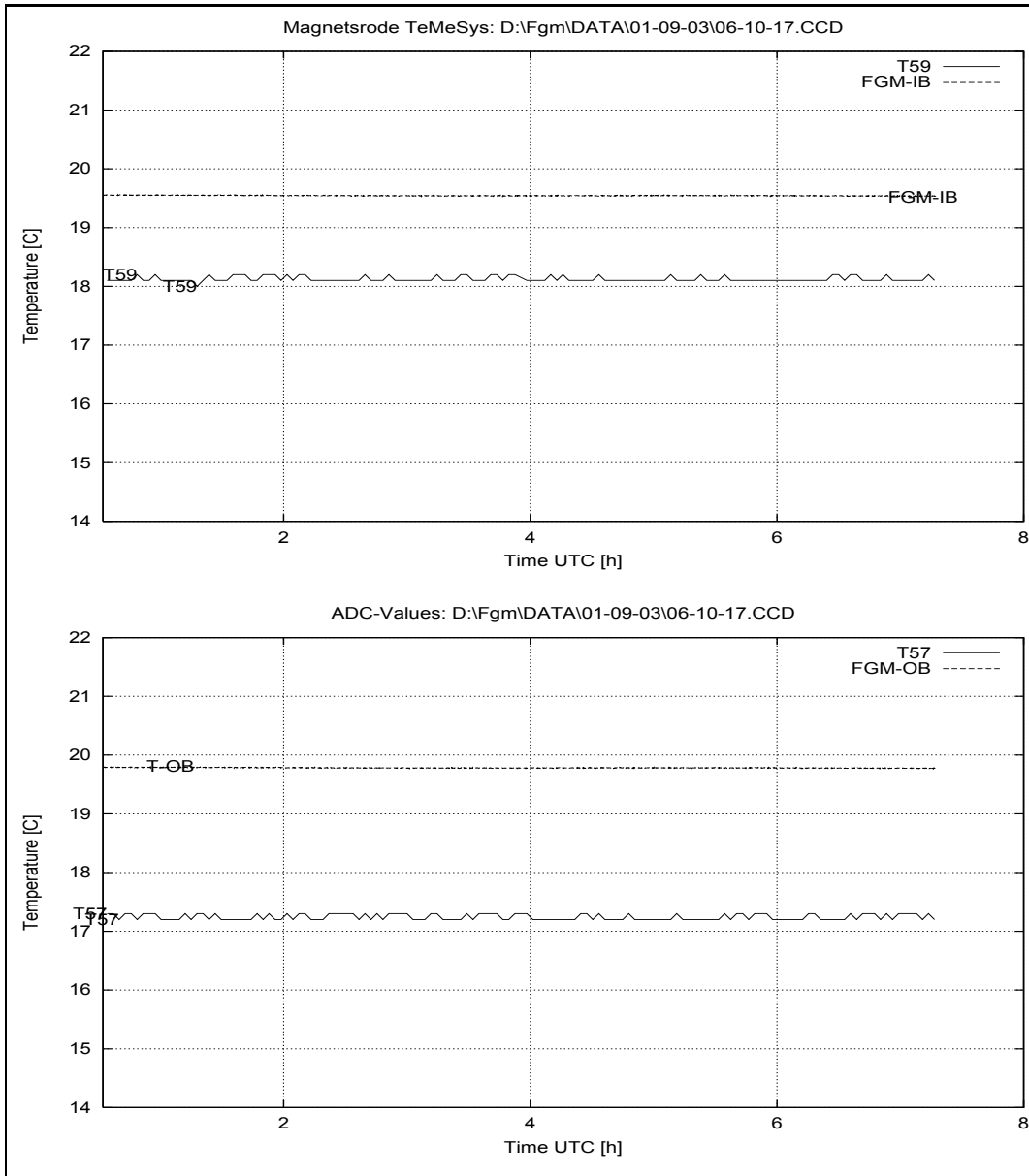

Figure 142: September 3, 2001: Sensor Temperatures at House 2.

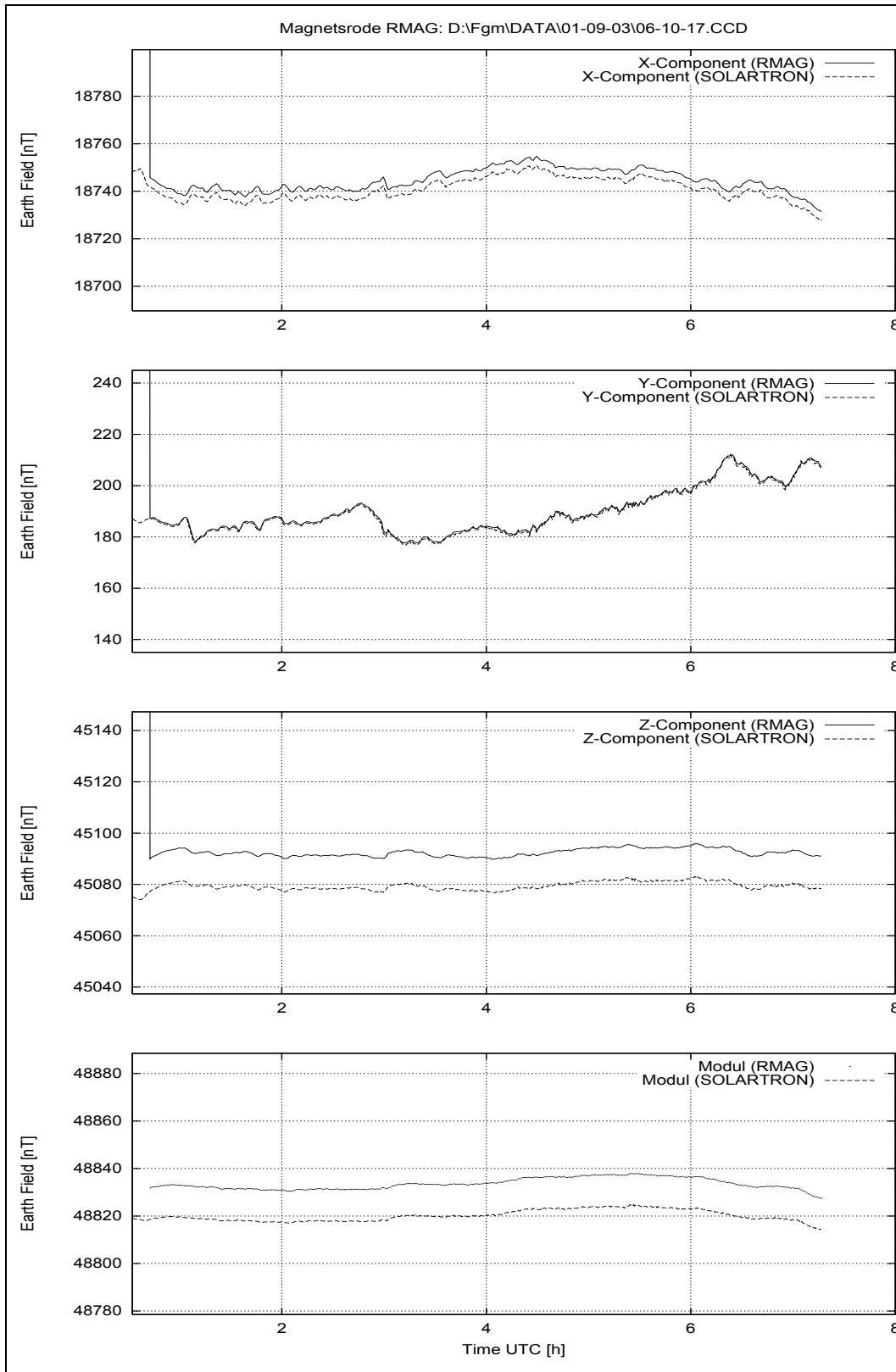

Figure 143: September 3, 2001: Earthfield variations.

R O S E T T A		Document: RO-IGM-TR-0002
		Issue: 2
		Revision: 2
IGM	Institut für Geophysik und Meteorologie	Date: October 10, 2001
	Technische Universität Braunschweig	Page: 211

35 Thursday September 6, 2001

35.1 Temperature Cycle, Linearities, DPU:FS, Sensors: FM

Before the temperature calibration will be performed some linearity measurements should be executed in the chosen setup for the temperature cycle. The sensors are fixed, but the box is still open for filling in the dry ice after these measurements.

Purpose: Measure the linearity of the FGM-FM sensors using the FS DPU.
Conditions: FM-OB and FM-IB placed in the Thermal Test Box on the aluminium support. The distance between them is 150 mm.
MAD: Ch0 to Ch2 connected to Zopfmag x to z, 10 nT/mV;
Ch7 FSP; Lower Reference position
Timer 500, SumUp 100, Vectorrate 1.00 Hz.
Files: T_LIN.SEQ
Start: 06.09.01 12:07
End: 06.09.01 12:50

35.1.1 Data

Configuration File	CCD File
ali10.CFG	01-09-06\12_07_17.CCD
TX15.CFG	01-09-06\12_14_27.CCD
TY15.CFG	01-09-06\12_27_28.CCD
TZ15.CFG	01-09-06\12_40_29.CCD

35.2 Temperature Calibration, Cooling Cycle, DPU:FS, Sensors: FM

Purpose: Measure the temperature behaviour of the FM sensors using the FS DPU.
Conditions: FM-OB and FM-IB placed in the Thermal Test Box on the aluminium support. The distance between them is 150 mm.
MAD: Ch0 to Ch2 connected to Zopfmag x to z, 10 nT/mV;
Ch7 FSP;
Timer 500, SumUp 100, Vectorrate 1.00 Hz.
Files: TEMP3.SEQ
Temperature File: ROSETTA5.CUR
Tctrlparam: FLDtime: 40 s – TCctrl times: 24 s / 40s
Start: 06.09.01 12:54
End: 10.09.01 13:58 ESC.
Remark: Dry ice filling from 12:55 – 13:02

<h1 style="margin: 0;">R O S E T T A</h1>	Document: RO-IGM-TR-0002 Issue: 2 Revision: 2 Date: October 10, 2001 Page: 212
<h1 style="margin: 0;">IGM</h1>	Institut für Geophysik und Meteorologie Technische Universität Braunschweig

35.2.1 Data

Configuration File	CCD File	Remark
TEMP.CFG	01-09-06\12_54_54.CCD	
TEMP.CFG	01-09-06\14_02_36.CCD	
TEMP.CFG	01-09-06\15_10_17.CCD	
TEMP.CFG	01-09-06\16_17_57.CCD	
TEMP.CFG	01-09-06\17_25_39.CCD	
TEMP.CFG	01-09-06\18_33_21.CCD	
TEMP.CFG	01-09-06\19_41_02.CCD	
TEMP.CFG	01-09-06\20_48_41.CCD	
TEMP.CFG	01-09-06\21_56_22.CCD	
TEMP.CFG	01-09-06\23_04_03.CCD	

35.3 Overview Plots: System Performance, Temperatures and Earth-field Variations.

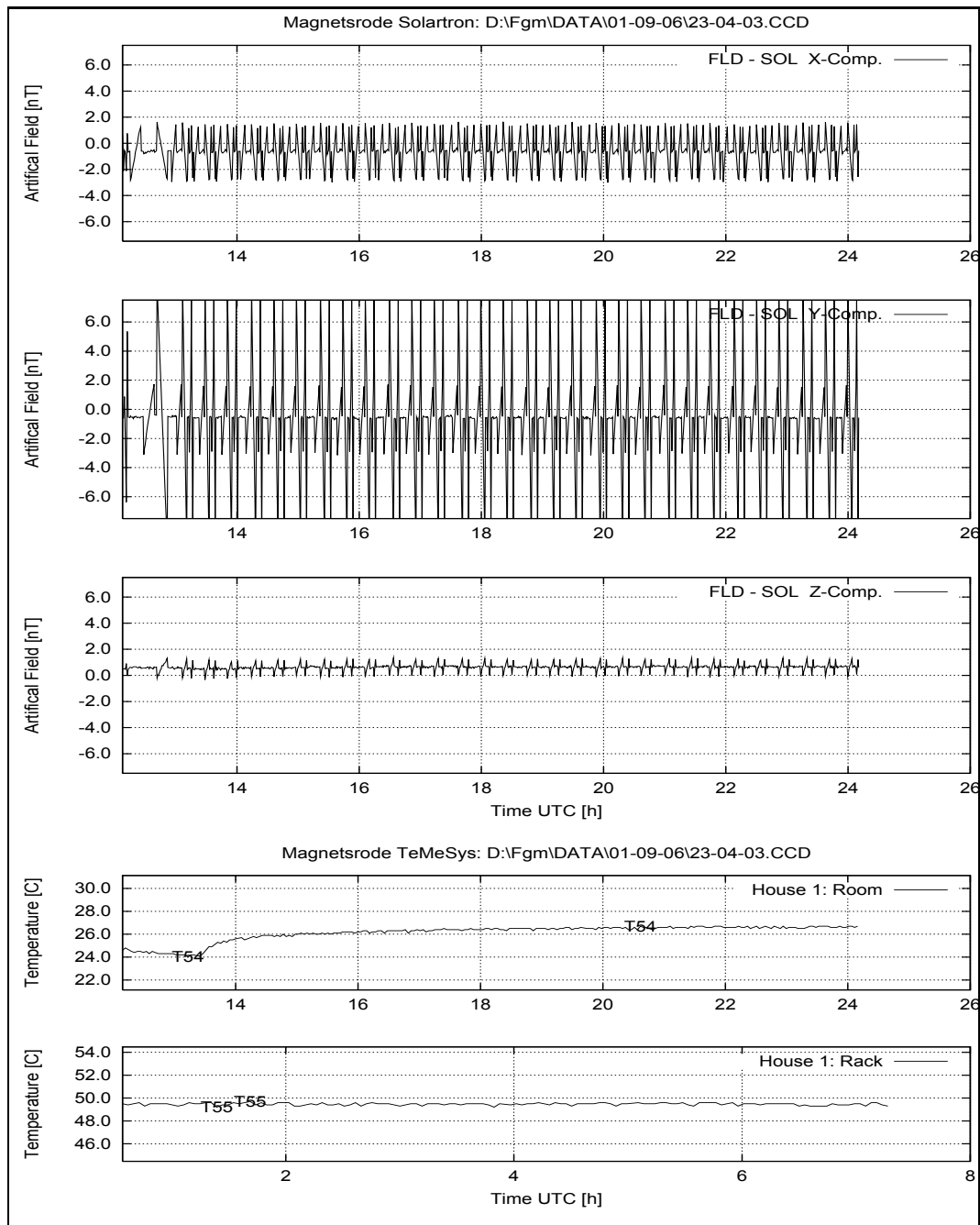

Figure 144: September 6, 2001: System Performance: FLD – SOL; Temperatures House 1.

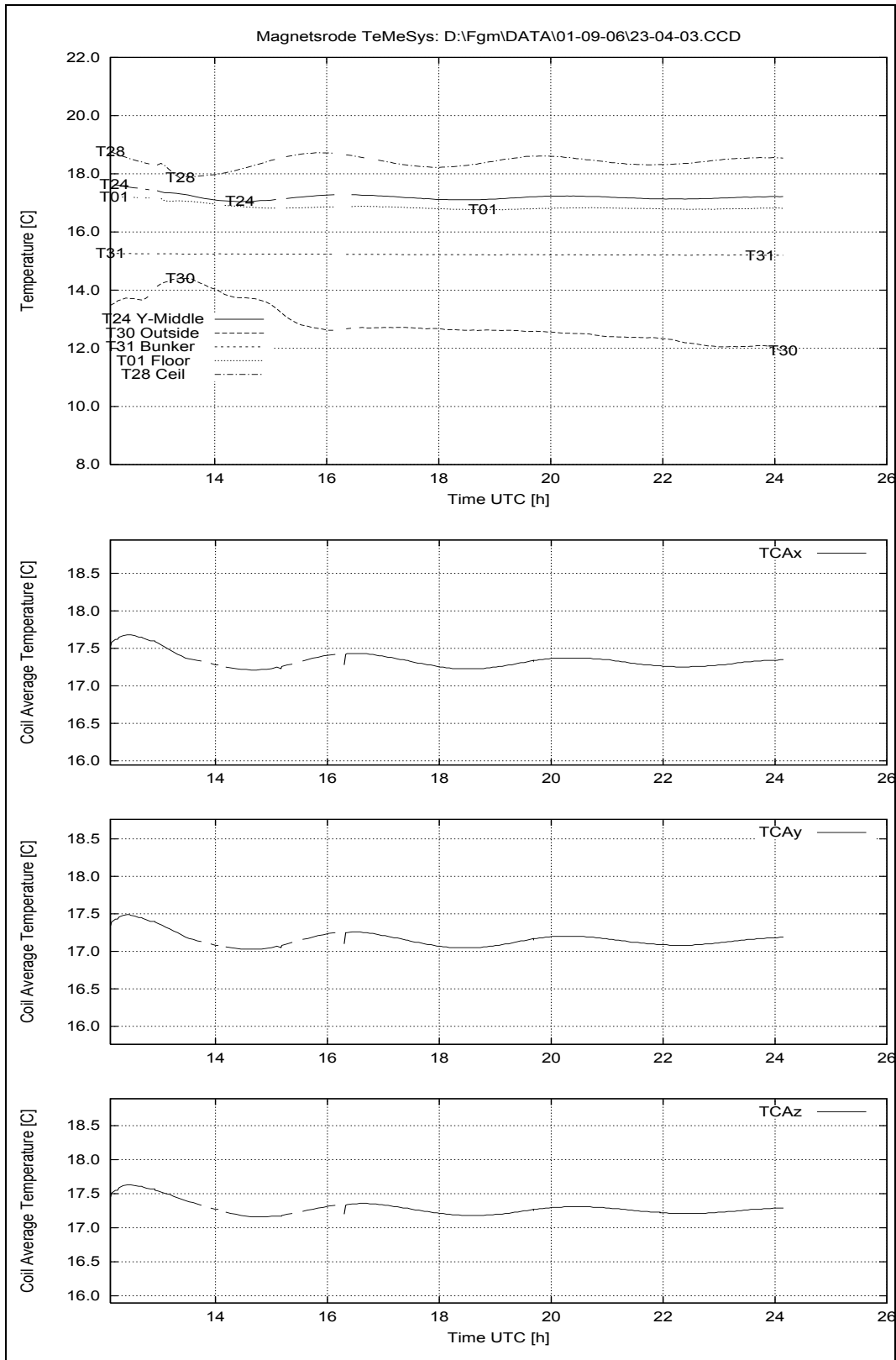

Figure 145: September 6, 2001: Temperatures House 2.

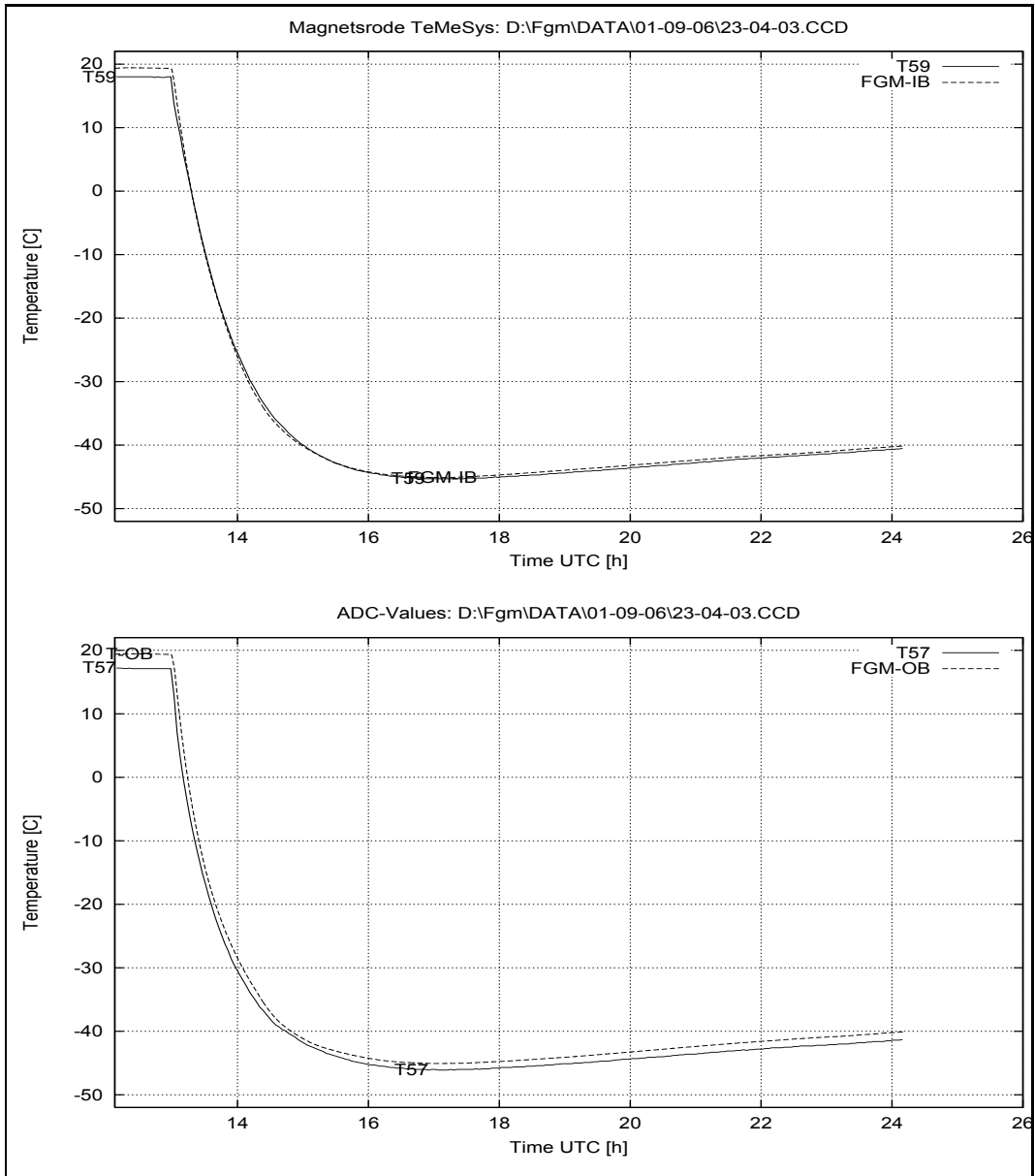

Figure 146: September 6, 2001: Sensor Temperatures at House 2.

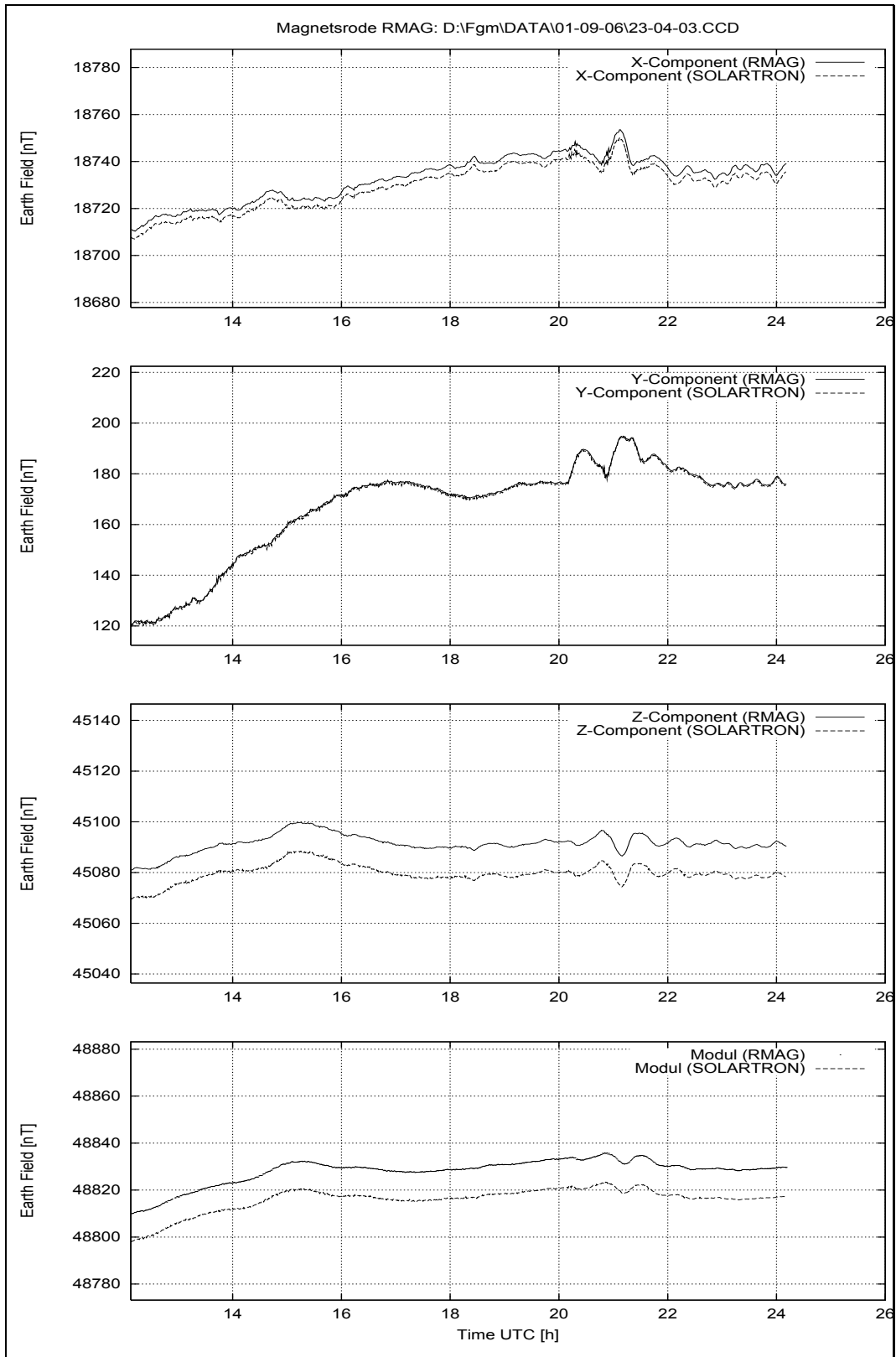

Figure 147: September 6, 2001: Earthfield variations.

R O S E T T A		Document: RO-IGM-TR-0002
		Issue: 2
		Revision: 2
IGM	Institut für Geophysik und Meteorologie	Date: October 10, 2001
	Technische Universität Braunschweig	Page: 217

36 Friday September 7, 2001

36.1 Temperature Calibration, Cooling Cycle continued, DPU:FS, Sensors: FM

The cooling cycle continued today without any personal support.

36.1.1 Data

Configuration File	CCD File	Remark
TEMP.CFG	01-09-07\00_11_43.CCD	
TEMP.CFG	01-09-07\01_19_24.CCD	
TEMP.CFG	01-09-07\02_27_06.CCD	
TEMP.CFG	01-09-07\03_34_46.CCD	
TEMP.CFG	01-09-07\04_42_26.CCD	
TEMP.CFG	01-09-07\05_50_07.CCD	
TEMP.CFG	01-09-07\06_58_11.CCD	
TEMP.CFG	01-09-07\08_05_52.CCD	
TEMP.CFG	01-09-07\09_14_24.CCD	
TEMP.CFG	01-09-07\10_22_04.CCD	
TEMP.CFG	01-09-07\11_29_45.CCD	
TEMP.CFG	01-09-07\12_37_25.CCD	
TEMP.CFG	01-09-07\13_45_05.CCD	
TEMP.CFG	01-09-07\14_52_46.CCD	
TEMP.CFG	01-09-07\16_00_27.CCD	
TEMP.CFG	01-09-07\17_08_10.CCD	
TEMP.CFG	01-09-07\18_15_50.CCD	
TEMP.CFG	01-09-07\19_23_30.CCD	
TEMP.CFG	01-09-07\20_31_10.CCD	
TEMP.CFG	01-09-07\21_38_51.CCD	
TEMP.CFG	01-09-07\22_46_32.CCD	
TEMP.CFG	01-09-07\23_54_13.CCD	

36.2 Overview Plots: System Performance, Temperatures and Earth-field Variations.

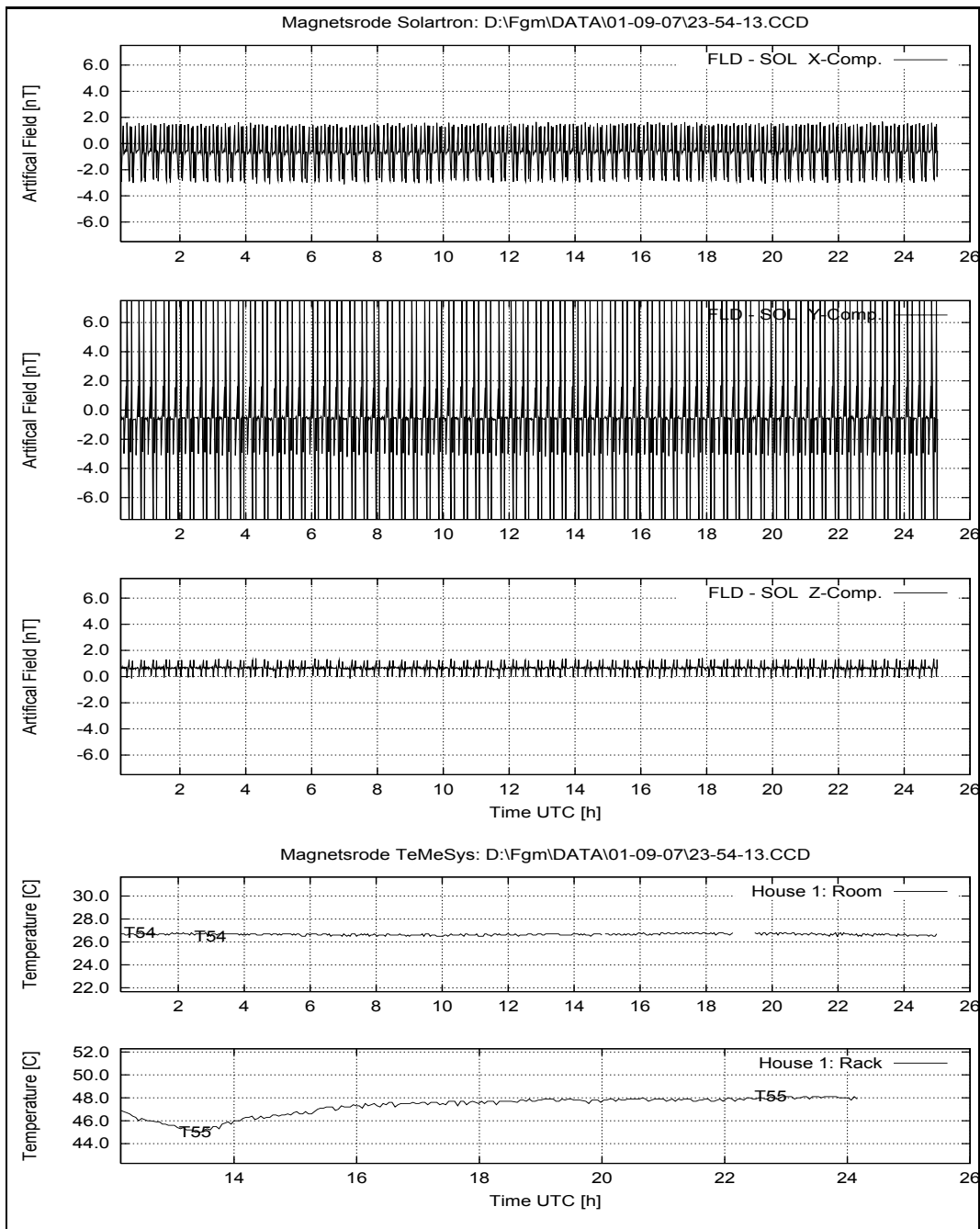

Figure 148: September 7, 2001: System Performance: FLD – SOL; Temperatures House 1.

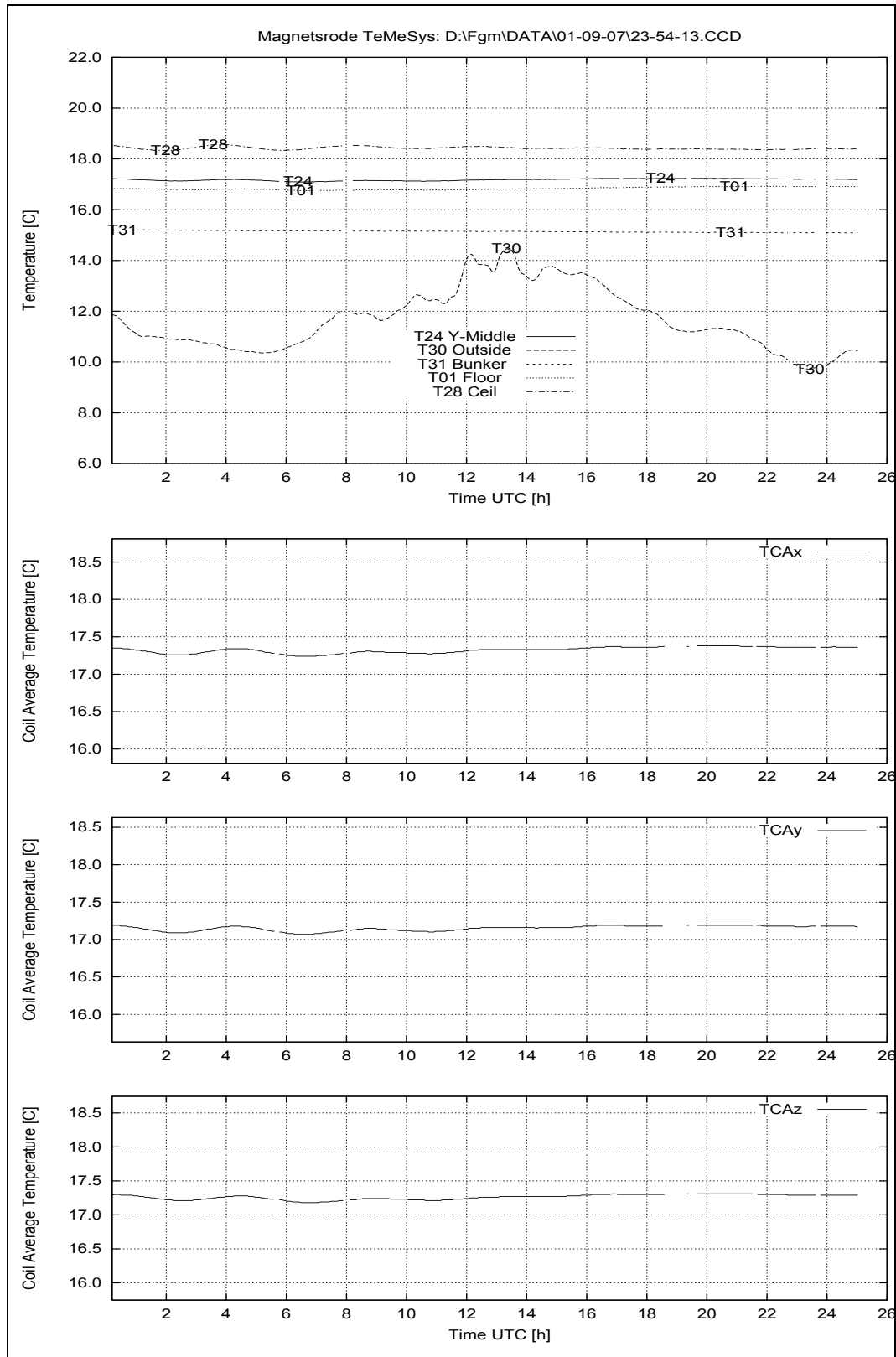

Figure 149: September 7, 2001: Temperatures House 2.

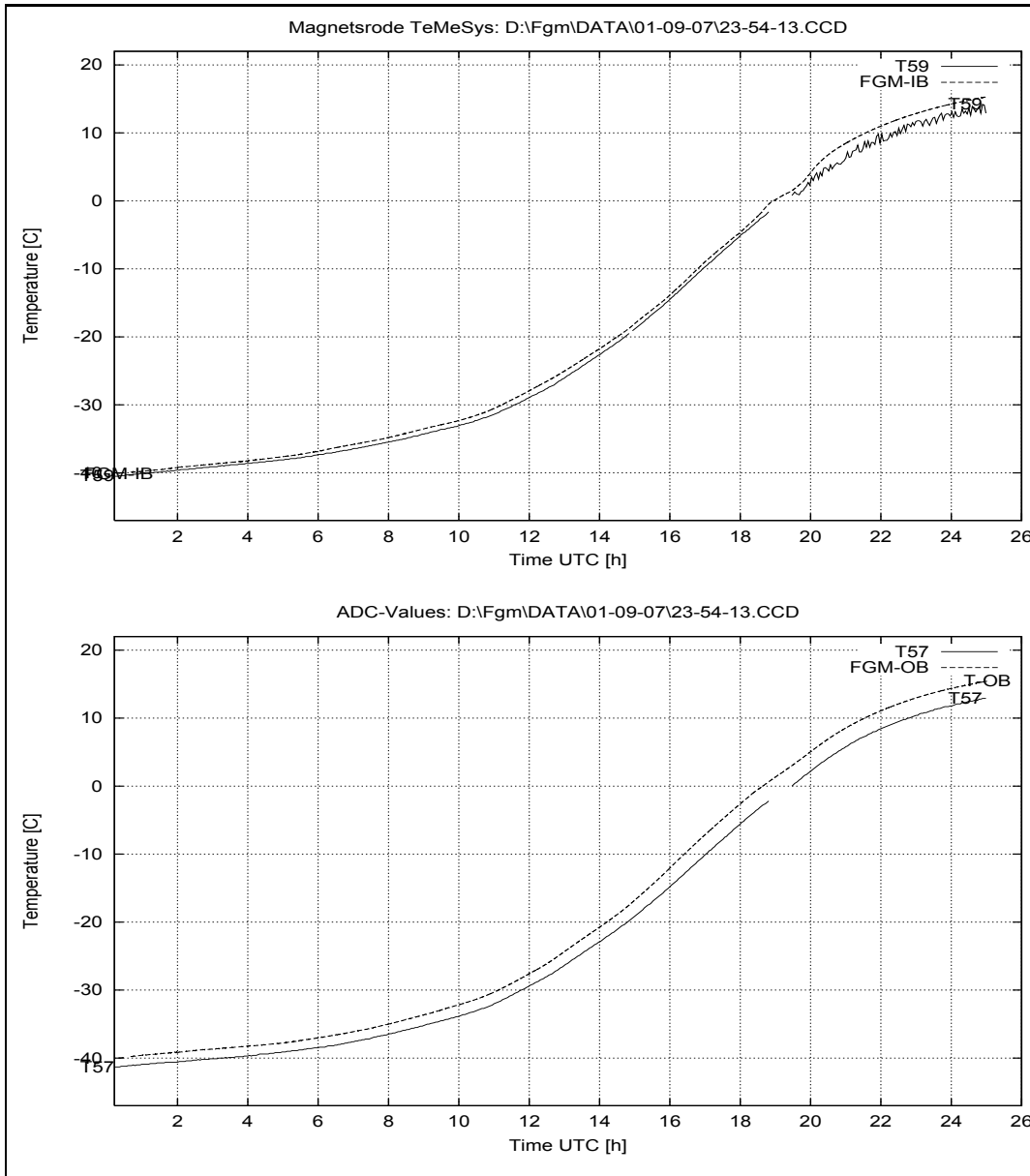

Figure 150: September 7, 2001: Sensor Temperatures at House 2.

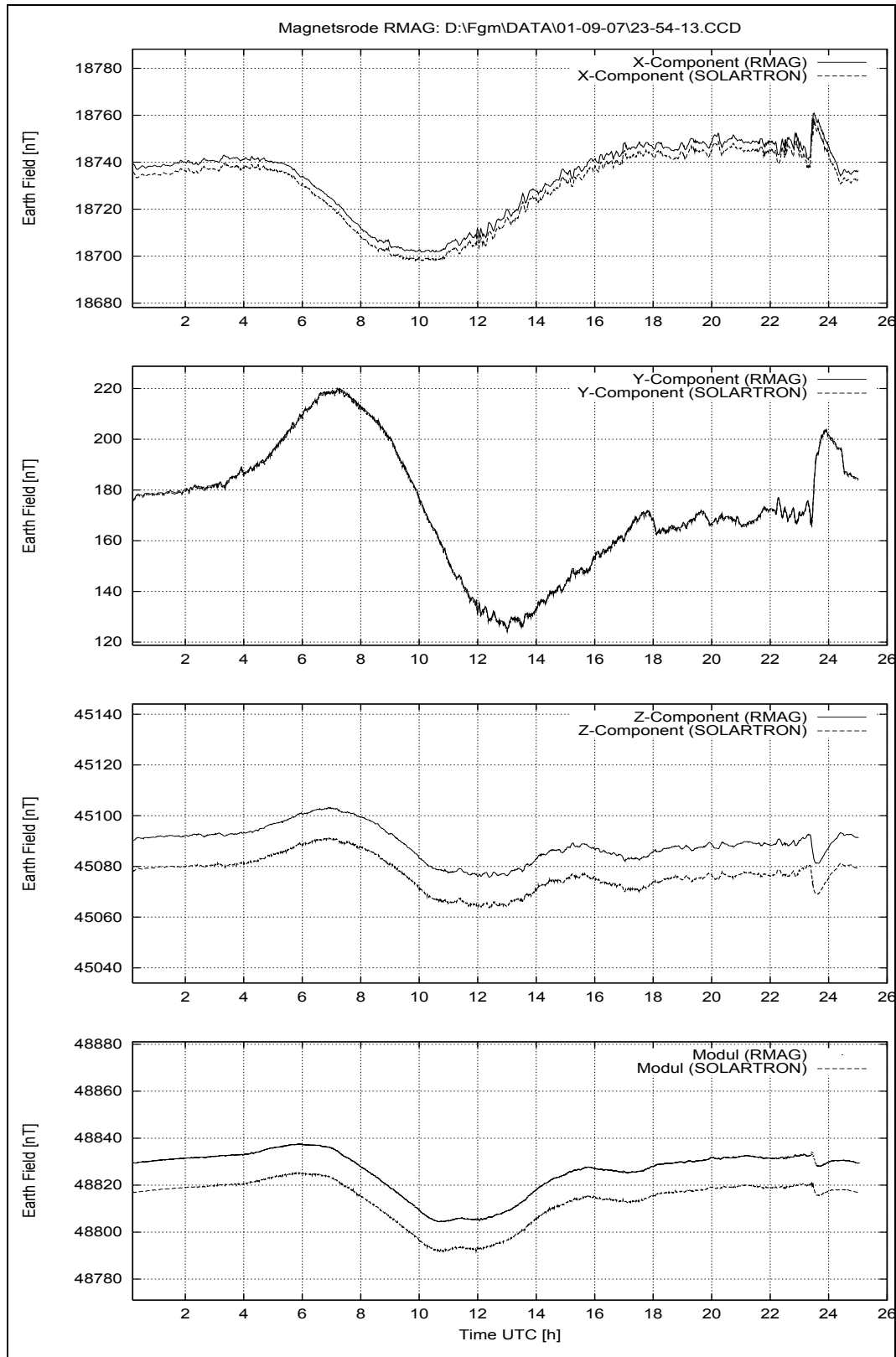

Figure 151: September 7, 2001: Earthfield variations.

R O S E T T A		Document: RO-IGM-TR-0002
		Issue: 2
		Revision: 2
IGM	Institut für Geophysik und Meteorologie	Date: October 10, 2001
	Technische Universität Braunschweig	Page: 222

37 Saturday September 8, 2001

37.1 Temperature Calibration, Cooling Cycle continued, DPU:FS, Sensors: FM

The cooling cycle continued today without any personal support.

37.1.1 Data

Configuration File	CCD File	Remark
TEMP.CFG	01-09-08\01_01_54.CCD	
TEMP.CFG	01-09-08\02_09_34.CCD	
TEMP.CFG	01-09-08\03_17_14.CCD	
TEMP.CFG	01-09-08\04_24_53.CCD	
TEMP.CFG	01-09-08\05_32_34.CCD	
TEMP.CFG	01-09-08\06_40_14.CCD	
TEMP.CFG	01-09-08\07_47_55.CCD	
TEMP.CFG	01-09-08\08_55_35.CCD	
TEMP.CFG	01-09-08\10_03_16.CCD	
TEMP.CFG	01-09-08\11_10_56.CCD	
TEMP.CFG	01-09-08\12_18_39.CCD	
TEMP.CFG	01-09-08\13_26_19.CCD	
TEMP.CFG	01-09-08\14_34_00.CCD	
TEMP.CFG	01-09-08\15_41_41.CCD	
TEMP.CFG	01-09-08\16_49_22.CCD	
TEMP.CFG	01-09-08\17_57_02.CCD	
TEMP.CFG	01-09-08\19_04_42.CCD	
TEMP.CFG	01-09-08\20_12_21.CCD	
TEMP.CFG	01-09-08\21_20_01.CCD	
TEMP.CFG	01-09-08\22_27_42.CCD	
TEMP.CFG	01-09-08\23_35_22.CCD	

37.2 Overview Plots: System Performance, Temperatures and Earth-field Variations.

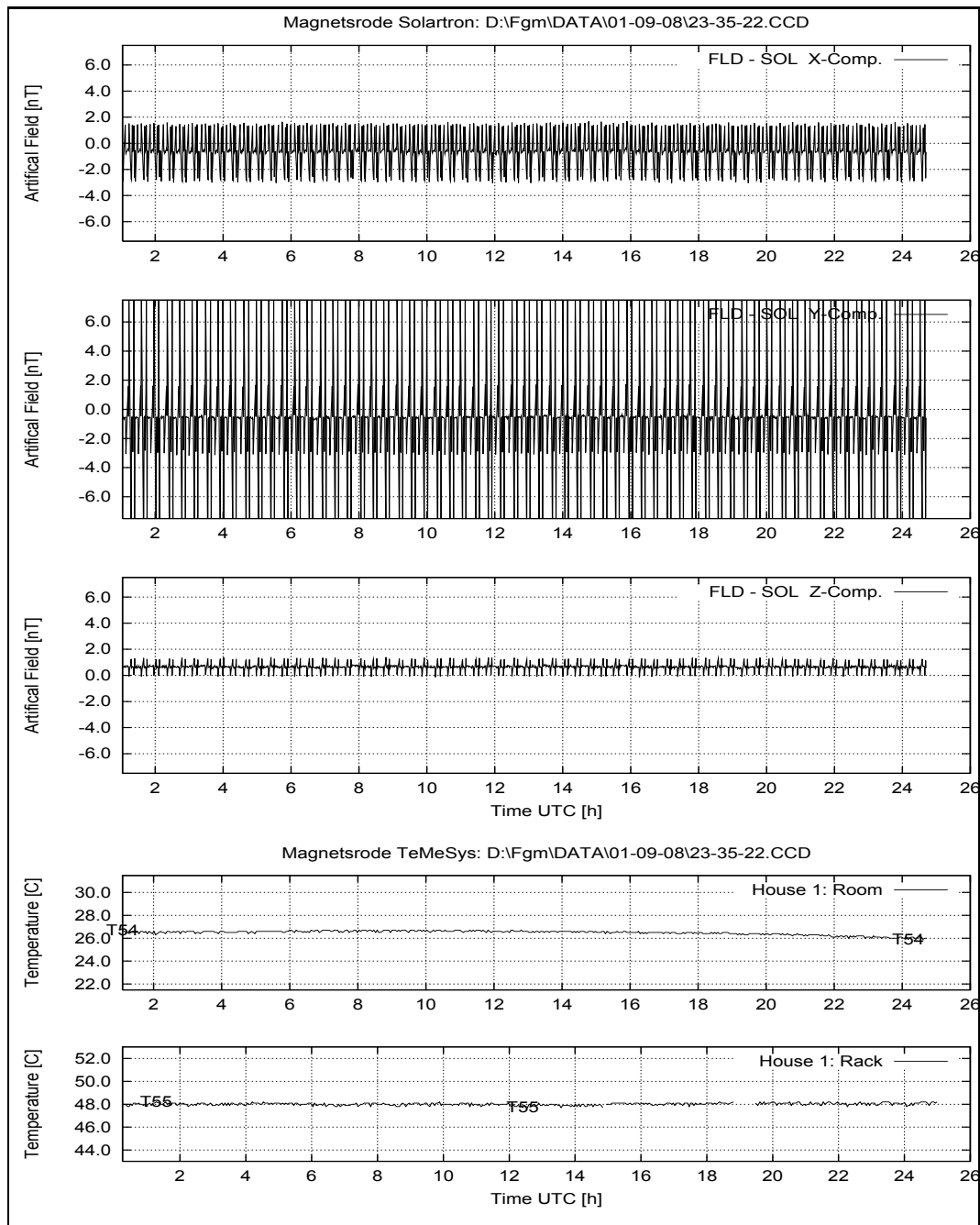

Figure 152: September 8, 2001: System Performance: FLD – SOL; Temperatures House 1.

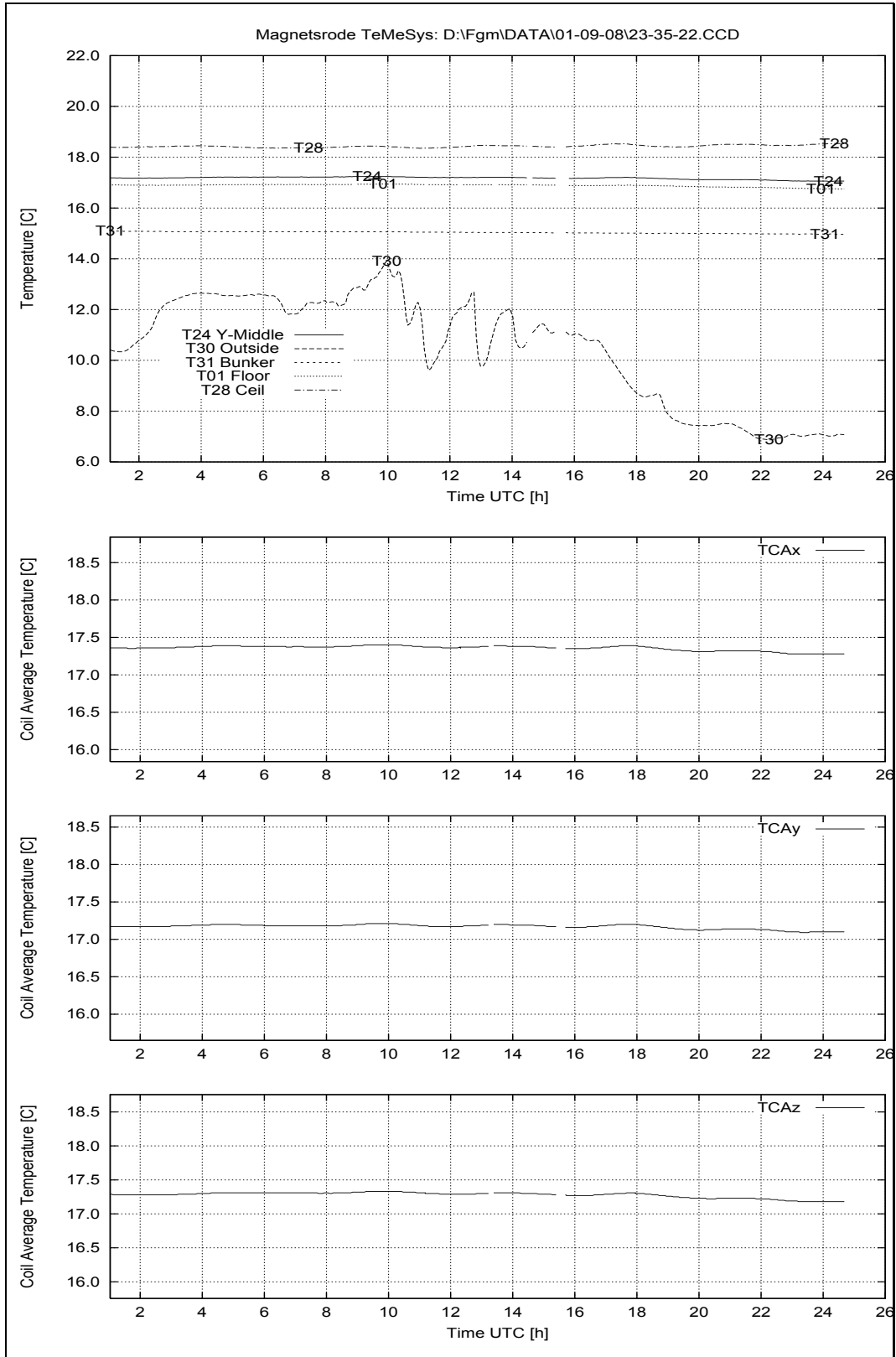

Figure 153: September 8, 2001: Temperatures House 2.

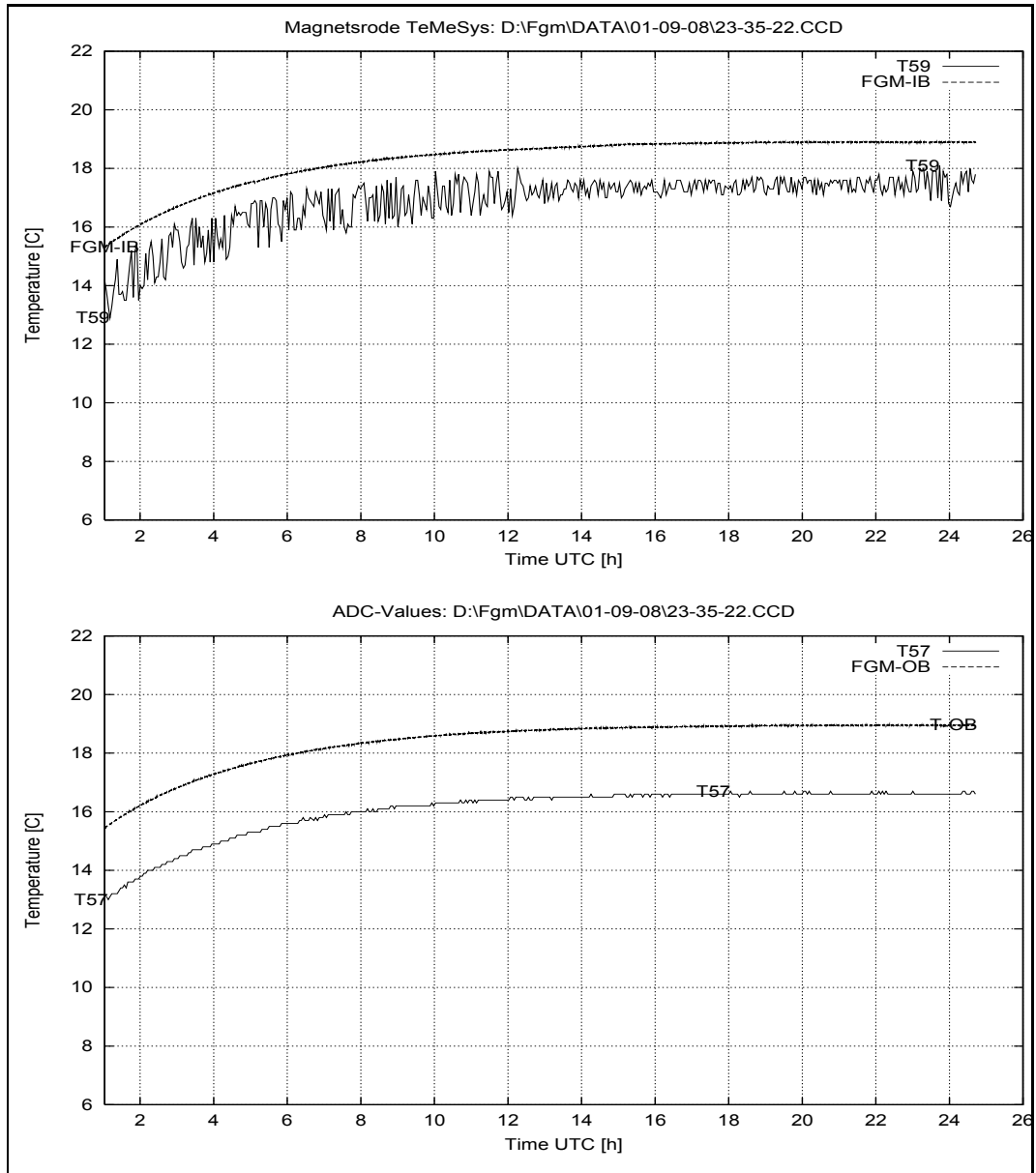

Figure 154: September 8, 2001: Sensor Temperatures at House 2.

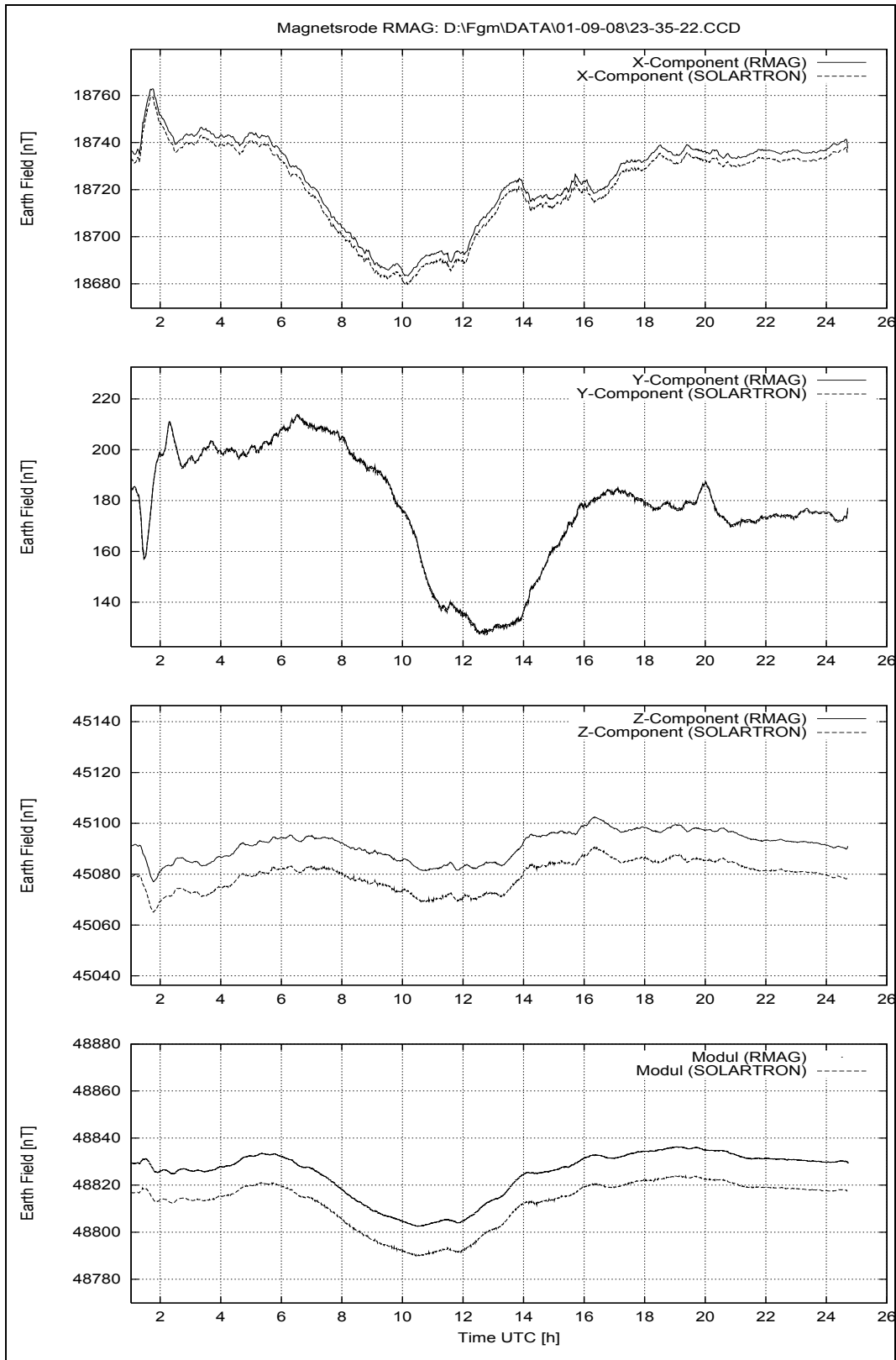

Figure 155: September 8, 2001: Earthfield variations.

R O S E T T A		Document: RO-IGM-TR-0002
IGM Institut für Geophysik und Meteorologie Technische Universität Braunschweig		Issue: 2
		Revision: 2
		Date: October 10, 2001
		Page: 227

38 Sunday September 9, 2001

38.1 Temperature Calibration, Cooling Cycle continued, DPU:FS, Sensors: FM

The cooling cycle continued today without any personal support.

The subsequent data analysis revealed that the thermistor of the FM-IB sensor showed a malfunction starting at 10:49 on September 9th while the temperature in the box was at about 18°C. The output voltage of this thermistor dropped to the half of the nominal voltage and decreased continuously until the end of the calibration. An inspection of the sensor afterwards, however, did not show any suspicious behaviour. All wires and soldering connections are ok.

38.1.1 Data

Configuration File	CCD File	Remark
TEMP.CFG	01-09-09\00_43_03.CCD	
TEMP.CFG	01-09-09\01_50_44.CCD	
TEMP.CFG	01-09-09\02_58_25.CCD	
TEMP.CFG	01-09-09\04_06_06.CCD	
TEMP.CFG	01-09-09\05_14_07.CCD	
TEMP.CFG	01-09-09\06_21_46.CCD	
TEMP.CFG	01-09-09\07_29_27.CCD	
TEMP.CFG	01-09-09\08_38_47.CCD	
TEMP.CFG	01-09-09\09_46_27.CCD	
TEMP.CFG	01-09-09\10_54_08.CCD	
TEMP.CFG	01-09-09\12_01_48.CCD	
TEMP.CFG	01-09-09\13_09_28.CCD	
TEMP.CFG	01-09-09\14_17_29.CCD	
TEMP.CFG	01-09-09\15_25_10.CCD	
TEMP.CFG	01-09-09\16_32_50.CCD	
TEMP.CFG	01-09-09\17_40_31.CCD	
TEMP.CFG	01-09-09\18_48_12.CCD	
TEMP.CFG	01-09-09\19_55_53.CCD	
TEMP.CFG	01-09-09\21_03_33.CCD	
TEMP.CFG	01-09-09\22_11_14.CCD	
TEMP.CFG	01-09-09\23_18_54.CCD	

38.2 Overview Plots: System Performance, Temperatures and Earth-field Variations.

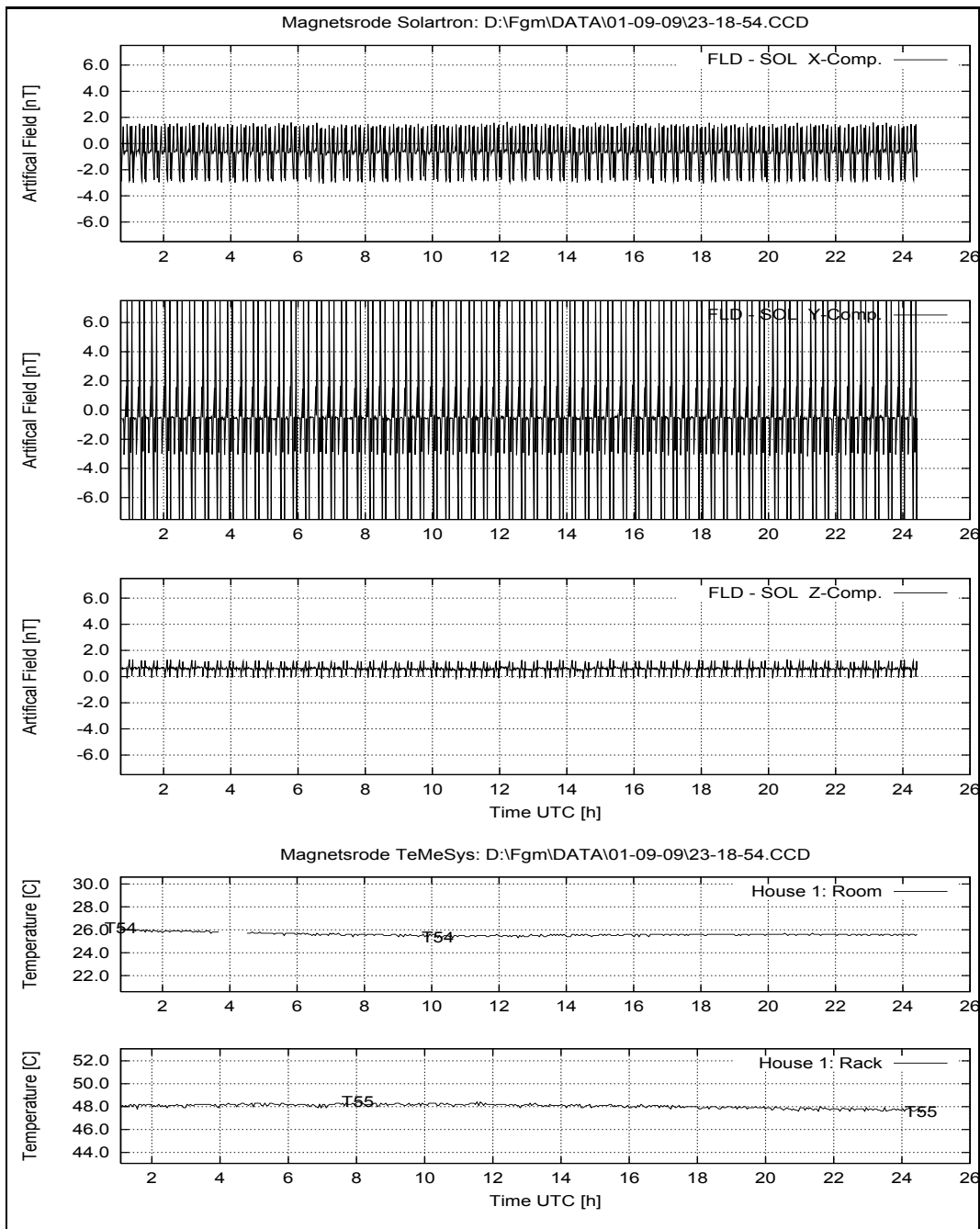

Figure 156: September 9, 2001: System Performance: FLD – SOL; Temperatures House 1.

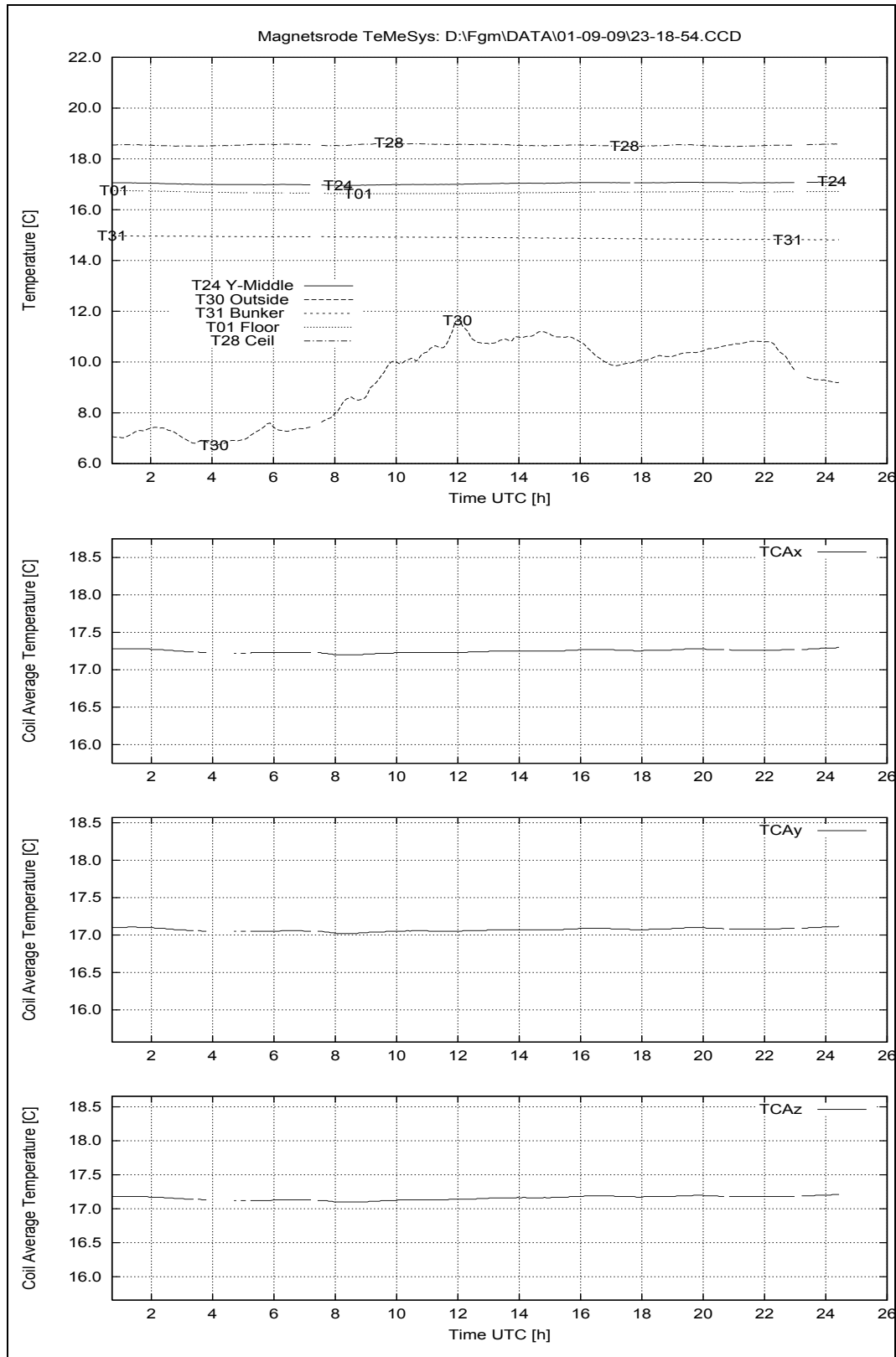

Figure 157: September 9, 2001: Temperatures House 2.

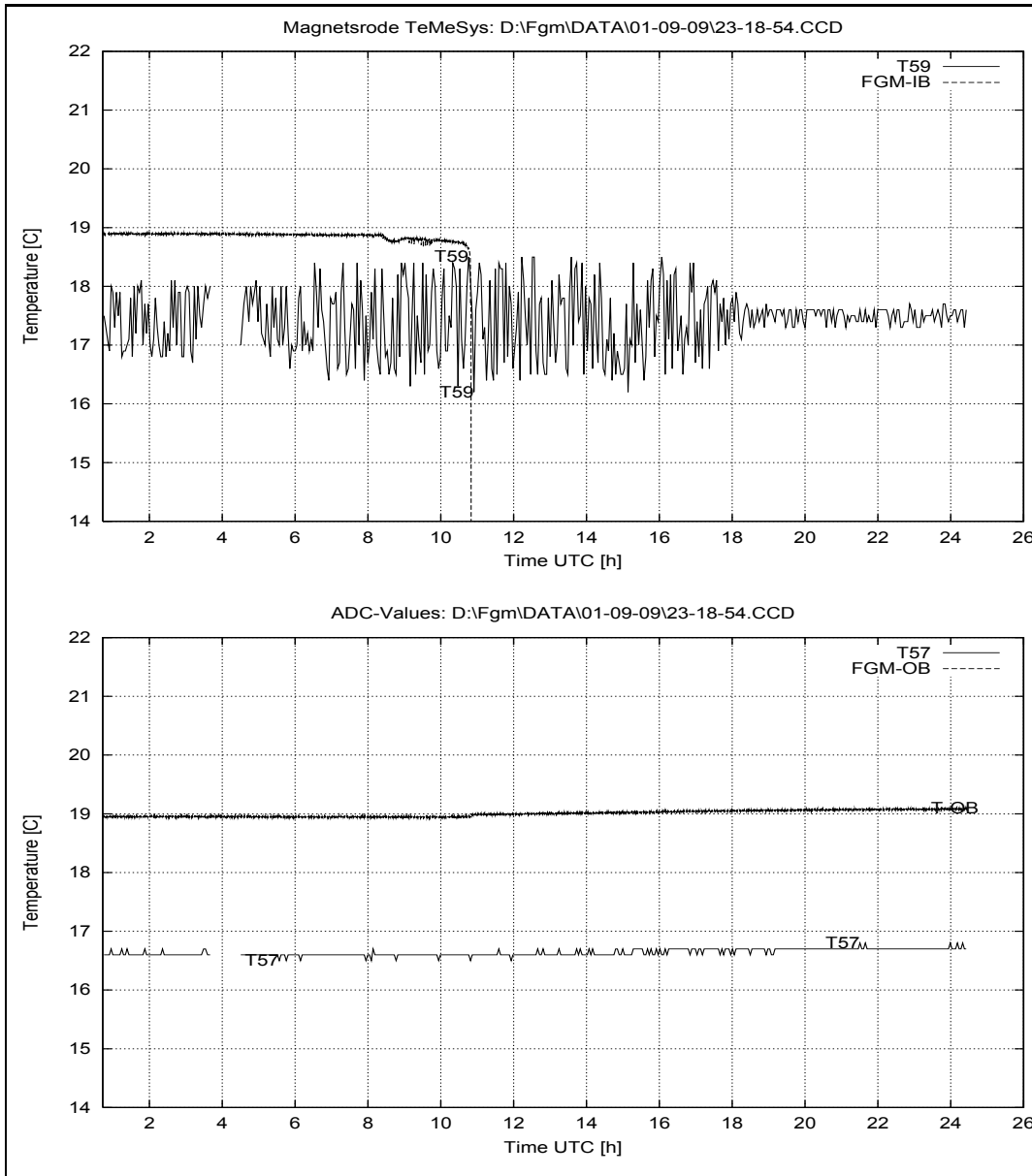

Figure 158: September 9, 2001: Sensor Temperatures at House 2.

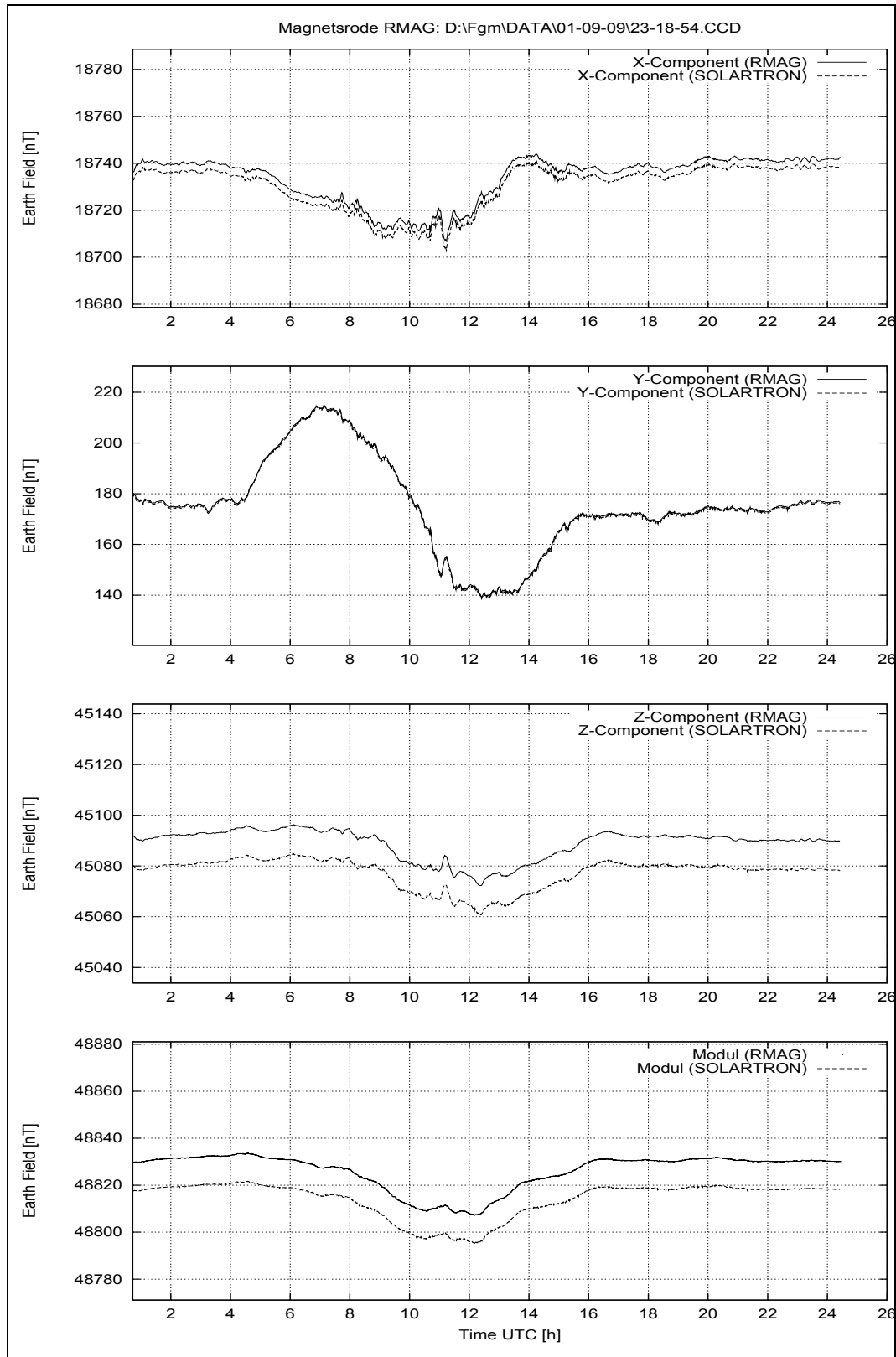

Figure 159: September 9, 2001: Earthfield variations.

R O S E T T A		Document: RO-IGM-TR-0002
		Issue: 2
		Revision: 2
IGM	Institut für Geophysik und Meteorologie	Date: October 10, 2001
	Technische Universität Braunschweig	Page: 232

39 Monday September 10, 2001

39.1 Temperature Calibration, Cooling Cycle continued, DPU:FS, Sensors: FM

The cooling cycle continued today until the early afternoon.

The heating cycle should have started automatically, but due to a loose contact of the supply cable at the heating foil inside the box the heating failed. Therefore, the box was opened, the contact was fixed and the system was restarted. Additionally the TeMeSys was rebooted, as it seemed to to be crashed.

39.1.1 Data

Configuration File	CCD File	Remark
TEMP.CFG	01-09-10\00_26_35.CCD	
TEMP.CFG	01-09-10\01_34_15.CCD	
TEMP.CFG	01-09-10\02_41_54.CCD	
TEMP.CFG	01-09-10\03_49_34.CCD	
TEMP.CFG	01-09-10\04_57_15.CCD	
TEMP.CFG	01-09-10\06_04_54.CCD	
TEMP.CFG	01-09-10\07_12_35.CCD	
TEMP.CFG	01-09-10\08_20_15.CCD	
TEMP.CFG	01-09-10\09_27_55.CCD	
TEMP.CFG	01-09-10\10_35_36.CCD	
TEMP.CFG	01-09-10\11_43_16.CCD	
TEMP.CFG	01-09-10\12_50_56.CCD	

R O S E T T A		Document: RO-IGM-TR-0002
		Issue: 2
		Revision: 2
IGM	Institut für Geophysik und Meteorologie Technische Universität Braunschweig	Date: October 10, 2001
		Page: 233

39.2 Temperature Calibration, Heating Cycle, DPU:FS, Sensors: FM

Purpose: Measure the temperature behaviour of the FM sensors using the FS DPU.

Conditions: FM-OB and FM-IB placed in the Thermal Test Box on the aluminium support. The distance between them is 150 mm.

MAD: Ch0 to Ch2 connected to Zopfmag x to z, 10 nT/mV;
Ch7 FSP;
Timer 500, SumUp 100, Vectorrate 1.00 Hz.

Files: TEMP3.SEQ

Temperature

File: ROSETTA5.CUR

Tctrlparam. FLDtime: 40 s – TCctrl times: 24 s / 40s

Start: 00.09.01 15:10

End: 13.09.01 07:00 ESC.

39.2.1 Data

Configuration File	CCD File	Remark
TEMP.CFG	01-09-10\15_10_43.CCD	
TEMP.CFG	01-09-10\16_18_24.CCD	
TEMP.CFG	01-09-10\17_27_04.CCD	
TEMP.CFG	01-09-10\18_34_43.CCD	
TEMP.CFG	01-09-10\19_42_24.CCD	
TEMP.CFG	01-09-10\20_50_04.CCD	
TEMP.CFG	01-09-10\21_57_44.CCD	
TEMP.CFG	01-09-10\23_05_25.CCD	

39.3 Overview Plots: System Performance, Temperatures and Earth-field Variations.

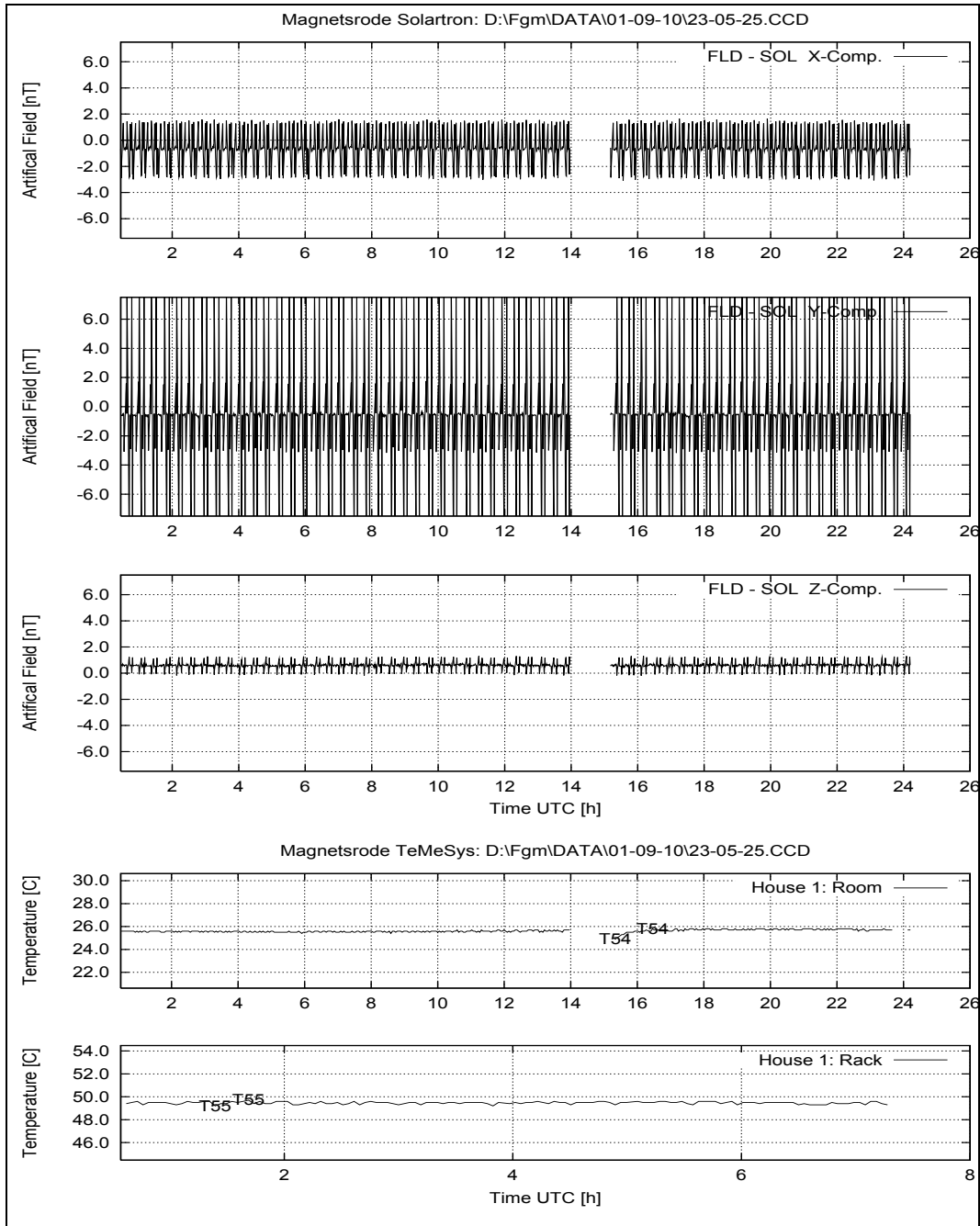

Figure 160: Sep. 10, 2001: System Performance: FLD – SOL; Temperatures House 1.

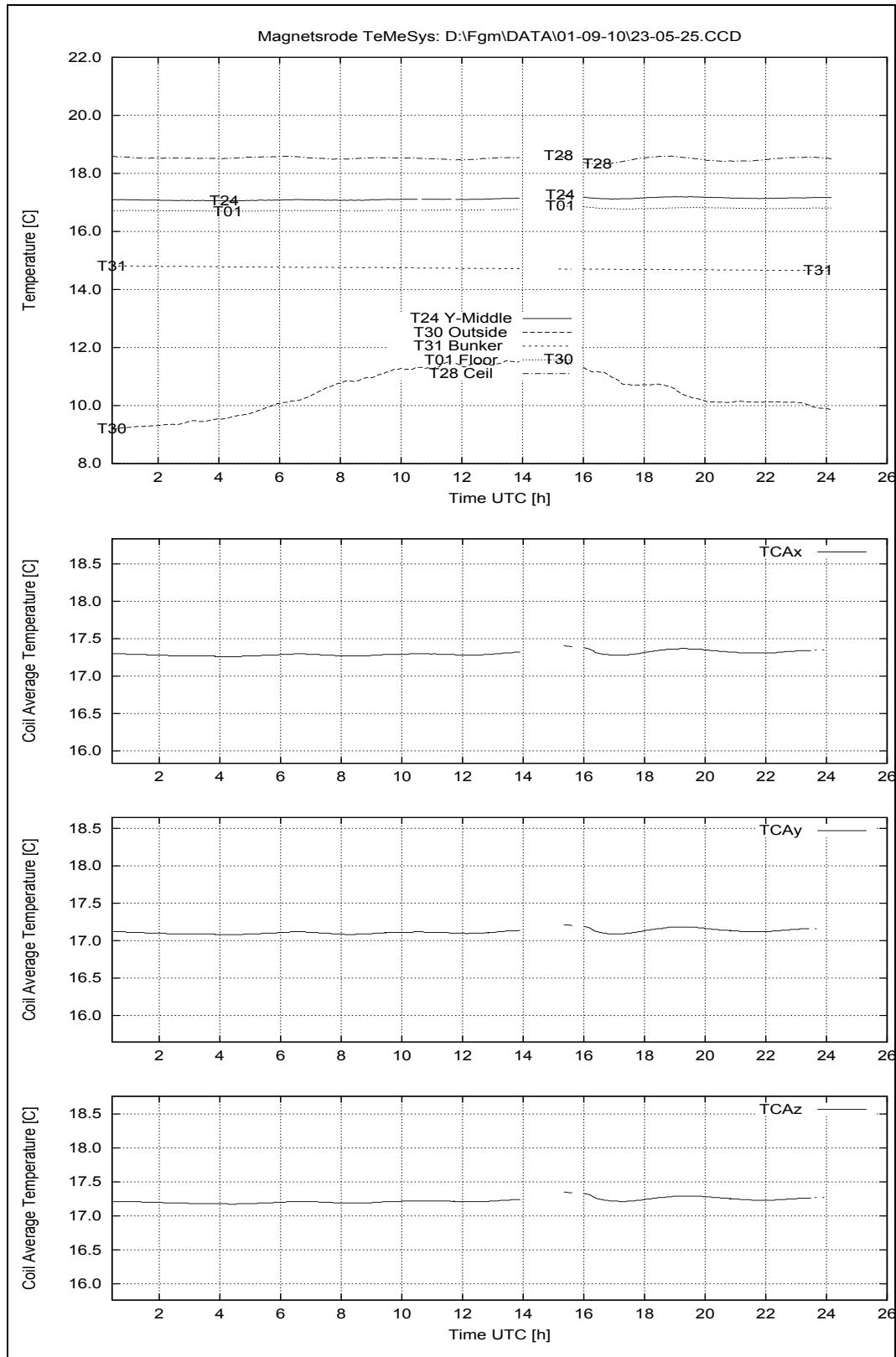

Figure 161: September 10, 2001: Temperatures House 2.

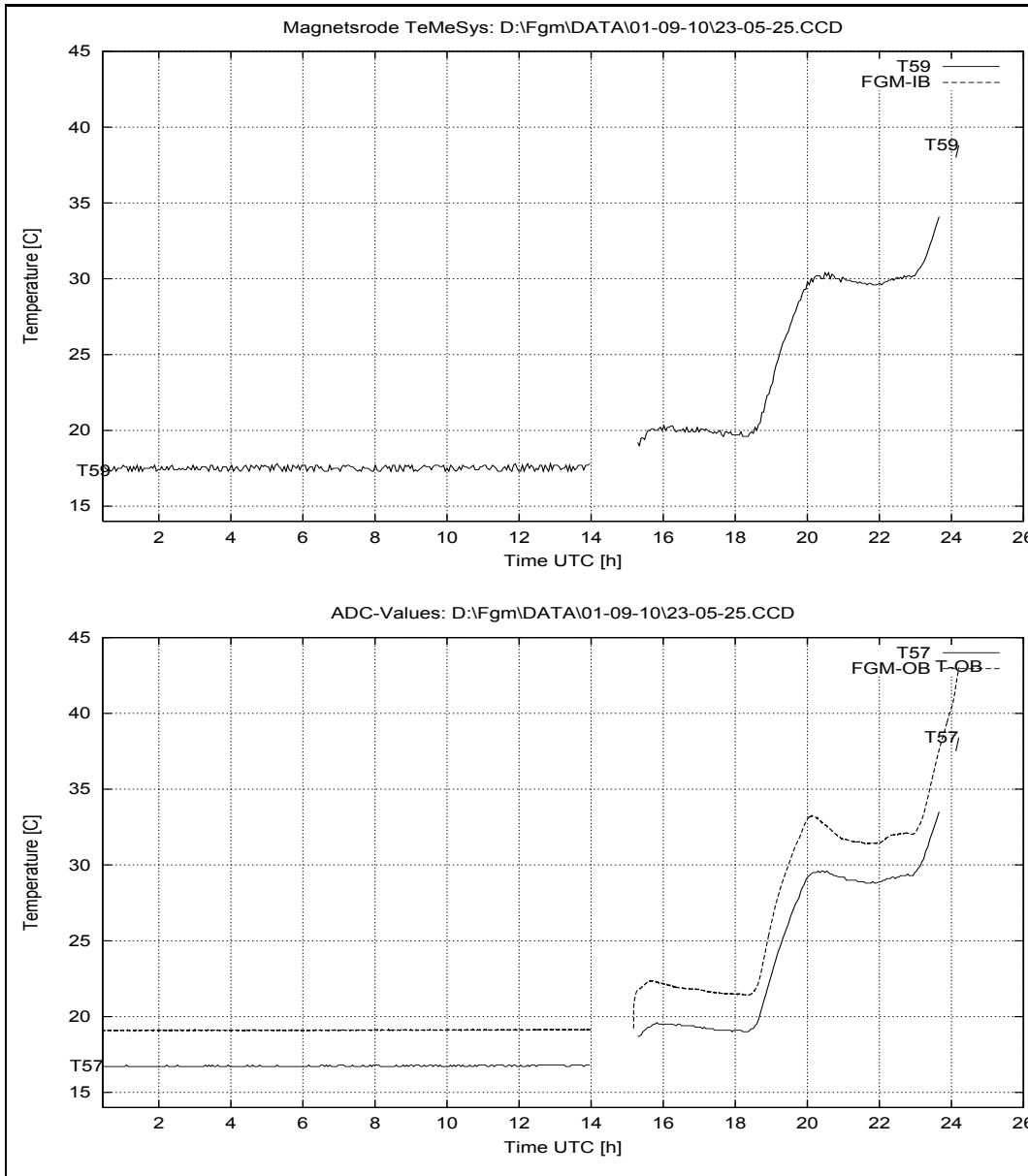

Figure 162: September 10, 2001: Sensor Temperatures at House 2.

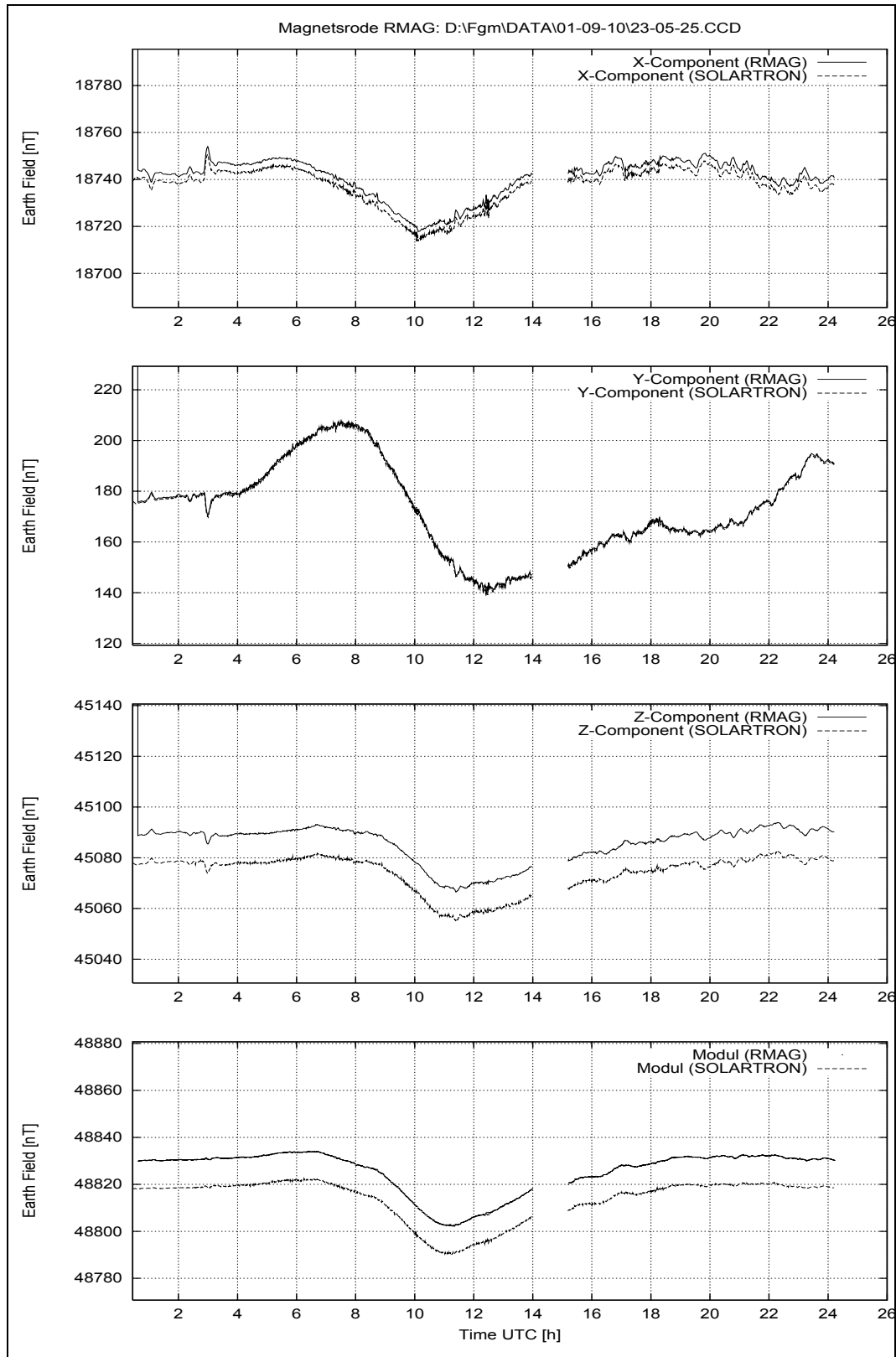

Figure 163: September 10, 2001: Earthfield variations.

R O S E T T A		Document: RO-IGM-TR-0002
		Issue: 2
		Revision: 2
IGM	Institut für Geophysik und Meteorologie	Date: October 10, 2001
	Technische Universität Braunschweig	Page: 238

40 Tuesday September 11, 2001

40.1 Temperature Calibration, Heating Cycle continued, DPU:FS, Sensors: FM

The heating cycle continued without any personal support today.

40.1.1 Data

Configuration File	CCD File	Remark
TEMP.CFG	01-09-11\00_13_06.CCD	
TEMP.CFG	01-09-11\01_20_47.CCD	
TEMP.CFG	01-09-11\02_28_28.CCD	
TEMP.CFG	01-09-11\03_36_08.CCD	
TEMP.CFG	01-09-11\04_43_49.CCD	
TEMP.CFG	01-09-11\05_51_59.CCD	
TEMP.CFG	01-09-11\06_59_40.CCD	
TEMP.CFG	01-09-11\08_07_33.CCD	
TEMP.CFG	01-09-11\09_15_12.CCD	
TEMP.CFG	01-09-11\10_22_53.CCD	
TEMP.CFG	01-09-11\11_30_33.CCD	
TEMP.CFG	01-09-11\12_38_13.CCD	
TEMP.CFG	01-09-11\13_45_52.CCD	
TEMP.CFG	01-09-11\14_53_33.CCD	
TEMP.CFG	01-09-11\16_01_13.CCD	
TEMP.CFG	01-09-11\17_08_54.CCD	
TEMP.CFG	01-09-11\18_16_35.CCD	
TEMP.CFG	01-09-11\19_24_16.CCD	
TEMP.CFG	01-09-11\20_31_57.CCD	
TEMP.CFG	01-09-11\21_39_38.CCD	
TEMP.CFG	01-09-11\22_47_17.CCD	
TEMP.CFG	01-09-11\23_54_58.CCD	

40.2 Overview Plots: System Performance, Temperatures and Earth-field Variations.

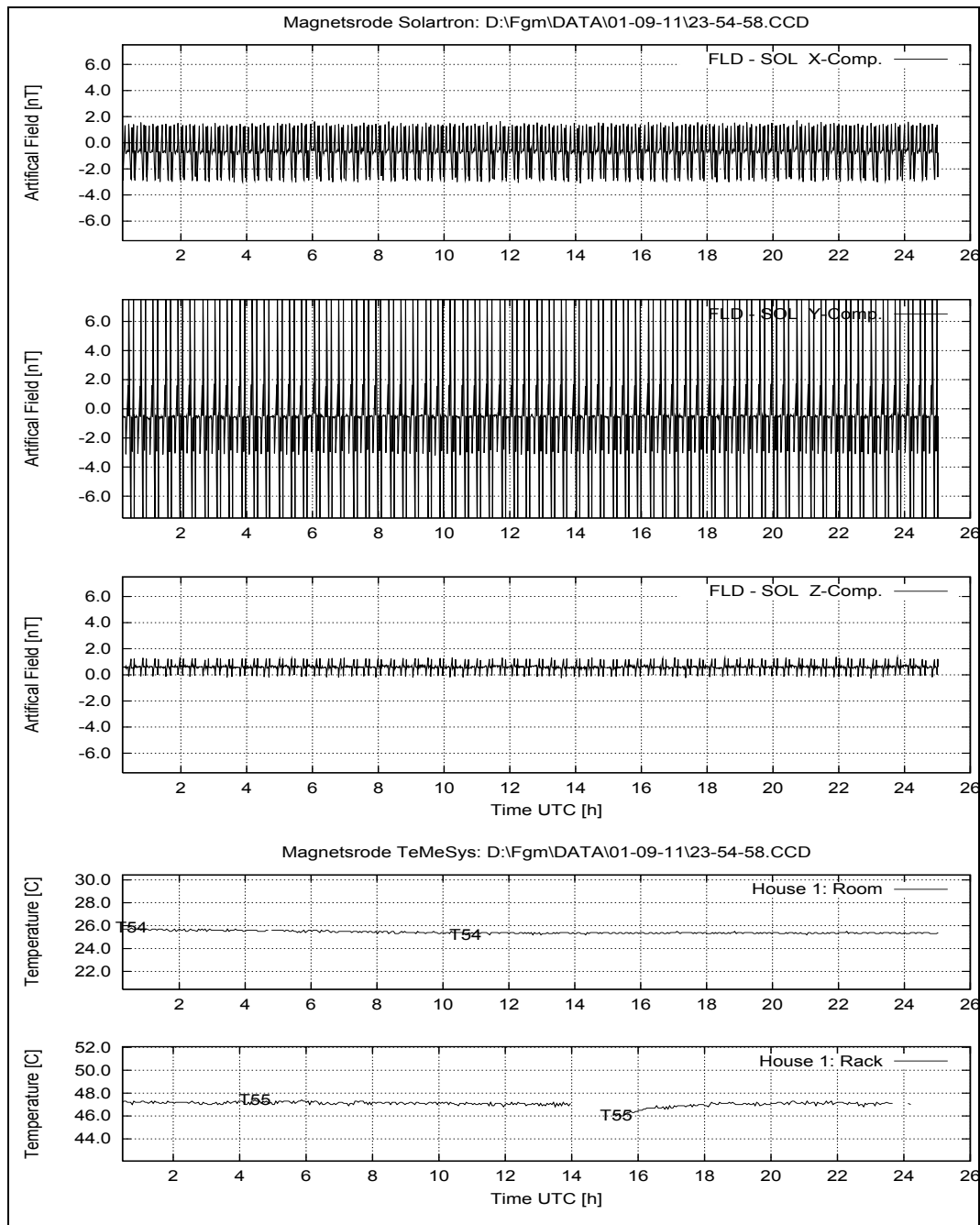

Figure 164: Sep. 11, 2001: System Performance: FLD – SOL; Temperatures House 1.

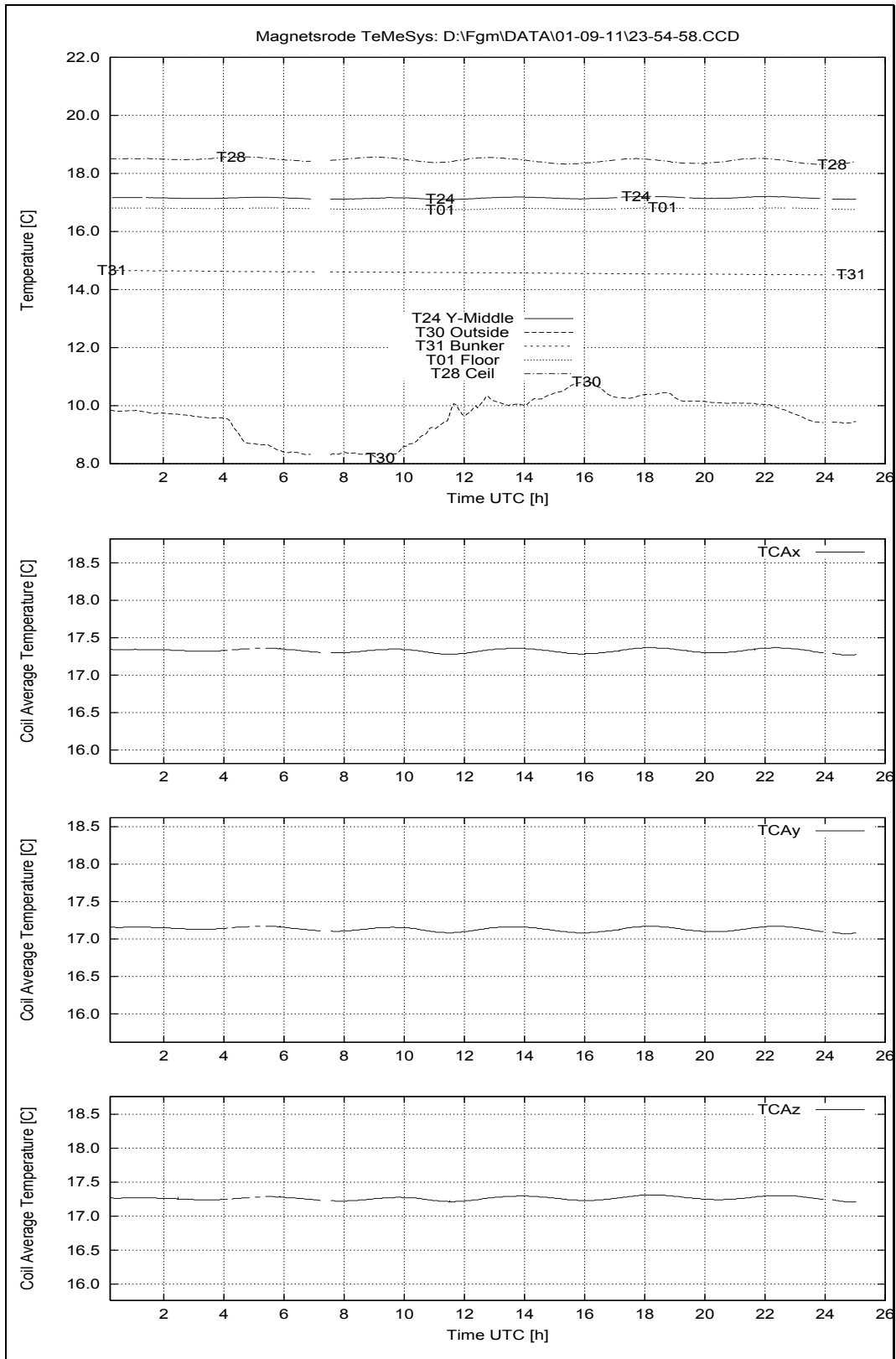

Figure 165: September 11, 2001: Temperatures House 2.

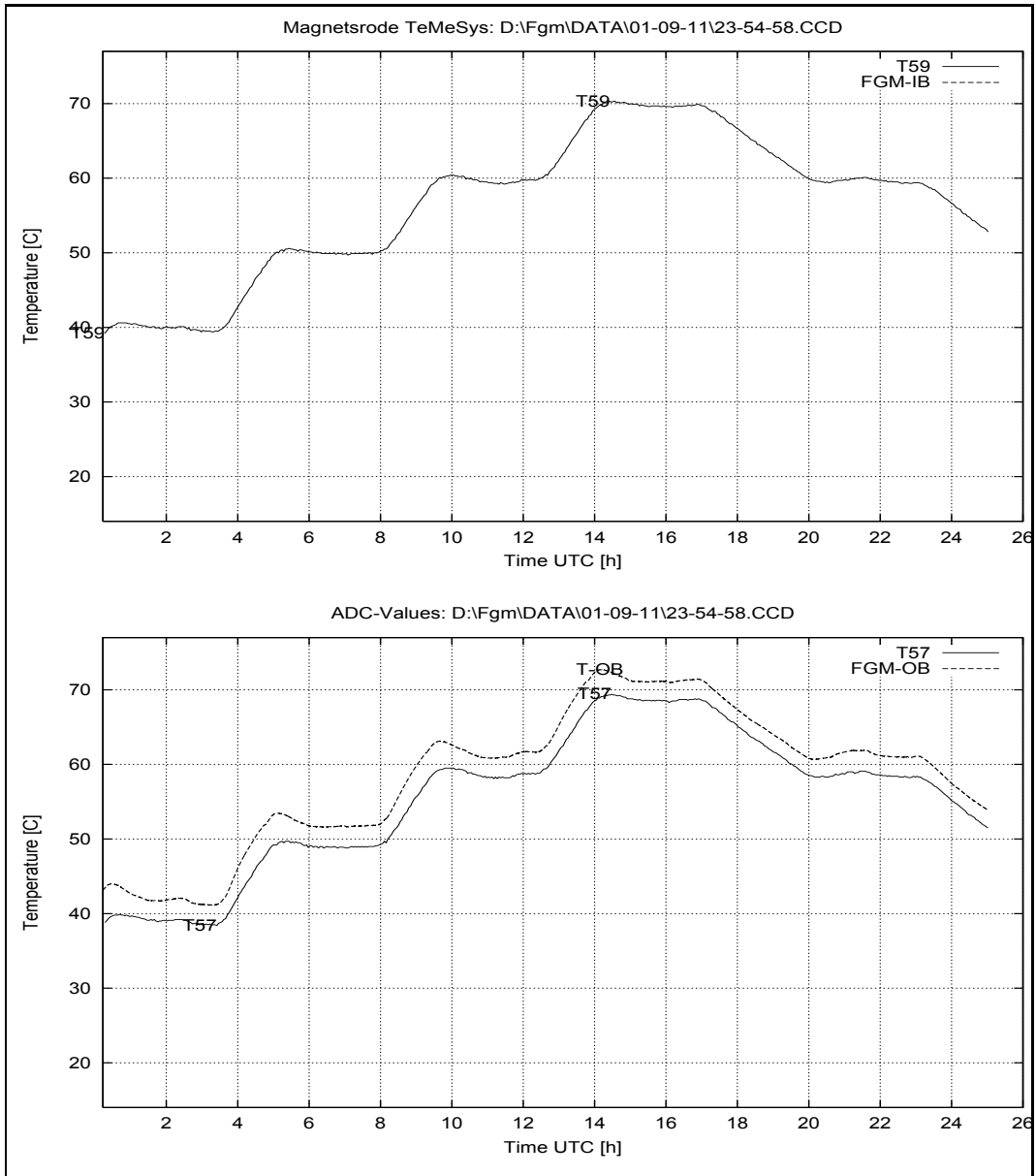

Figure 166: September 11, 2001: Sensor Temperatures at House 2.

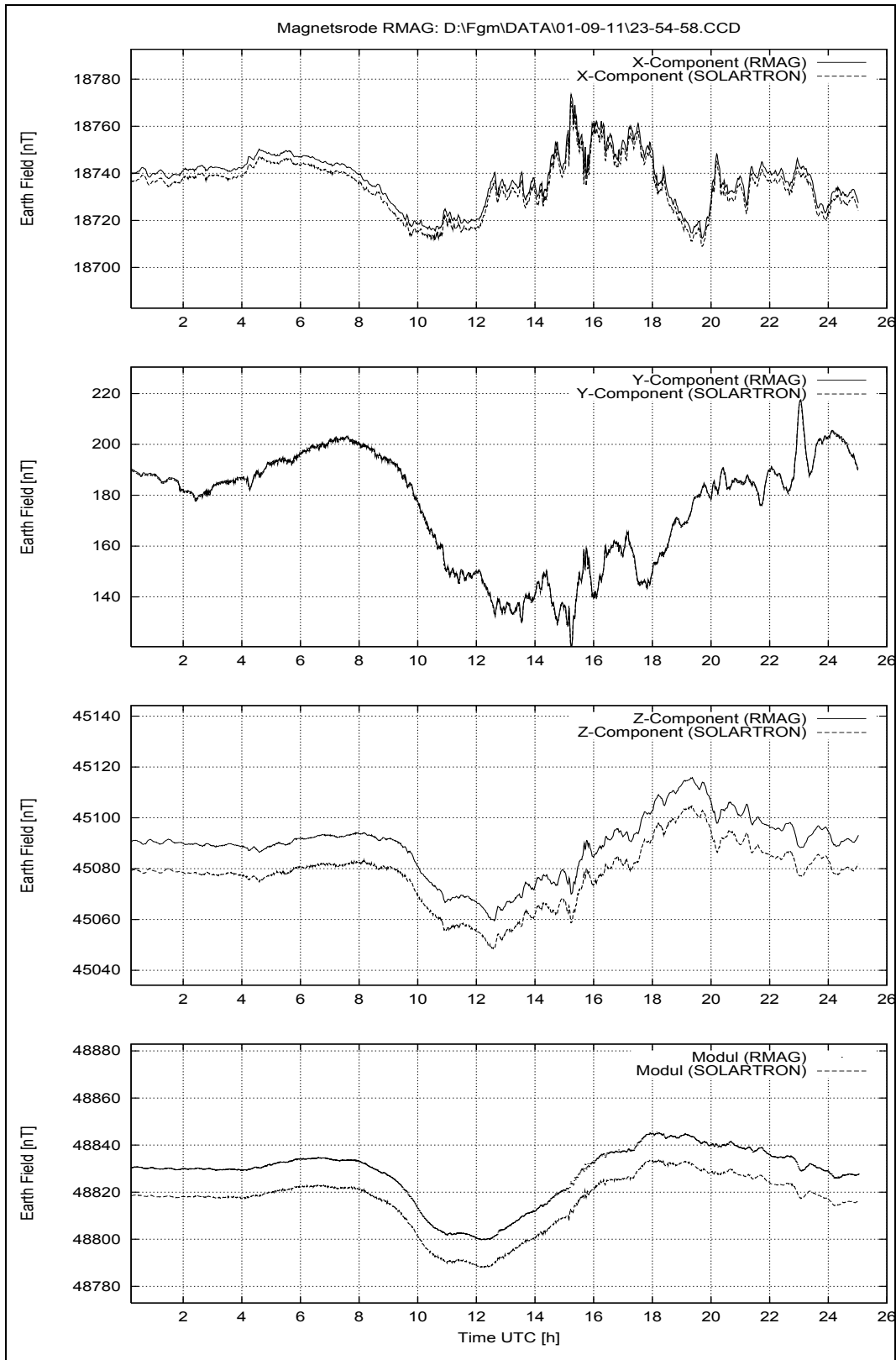

Figure 167: September 11, 2001: Earthfield variations.

R O S E T T A		Document: RO-IGM-TR-0002
		Issue: 2
		Revision: 2
IGM	Institut für Geophysik und Meteorologie	Date: October 10, 2001
	Technische Universität Braunschweig	Page: 243

41 Wednesday September 12, 2001

41.1 Temperature Calibration, Heating Cycle continued, DPU:FS, Sensors: FM

The heating cycle continued without any personal support today.

41.1.1 Data

Configuration File	CCD File	Remark
TEMP.CFG	01-09-12\01_02_38.CCD	
TEMP.CFG	01-09-12\02_10_18.CCD	
TEMP.CFG	01-09-12\03_17_59.CCD	
TEMP.CFG	01-09-12\04_25_39.CCD	
TEMP.CFG	01-09-12\05_33_19.CCD	
TEMP.CFG	01-09-12\06_40_59.CCD	
TEMP.CFG	01-09-12\07_49_00.CCD	
TEMP.CFG	01-09-12\08_56_40.CCD	
TEMP.CFG	01-09-12\10_04_21.CCD	
TEMP.CFG	01-09-12\11_12_02.CCD	
TEMP.CFG	01-09-12\12_19_42.CCD	
TEMP.CFG	01-09-12\13_27_23.CCD	
TEMP.CFG	01-09-12\14_35_29.CCD	
TEMP.CFG	01-09-12\15_43_38.CCD	
TEMP.CFG	01-09-12\16_51_18.CCD	
TEMP.CFG	01-09-12\17_58_58.CCD	
TEMP.CFG	01-09-12\19_06_39.CCD	
TEMP.CFG	01-09-12\20_14_19.CCD	
TEMP.CFG	01-09-12\21_21_59.CCD	
TEMP.CFG	01-09-12\22_29_40.CCD	
TEMP.CFG	01-09-12\23_37_21.CCD	

41.2 Overview Plots: System Performance, Temperatures and Earth-field Variations.

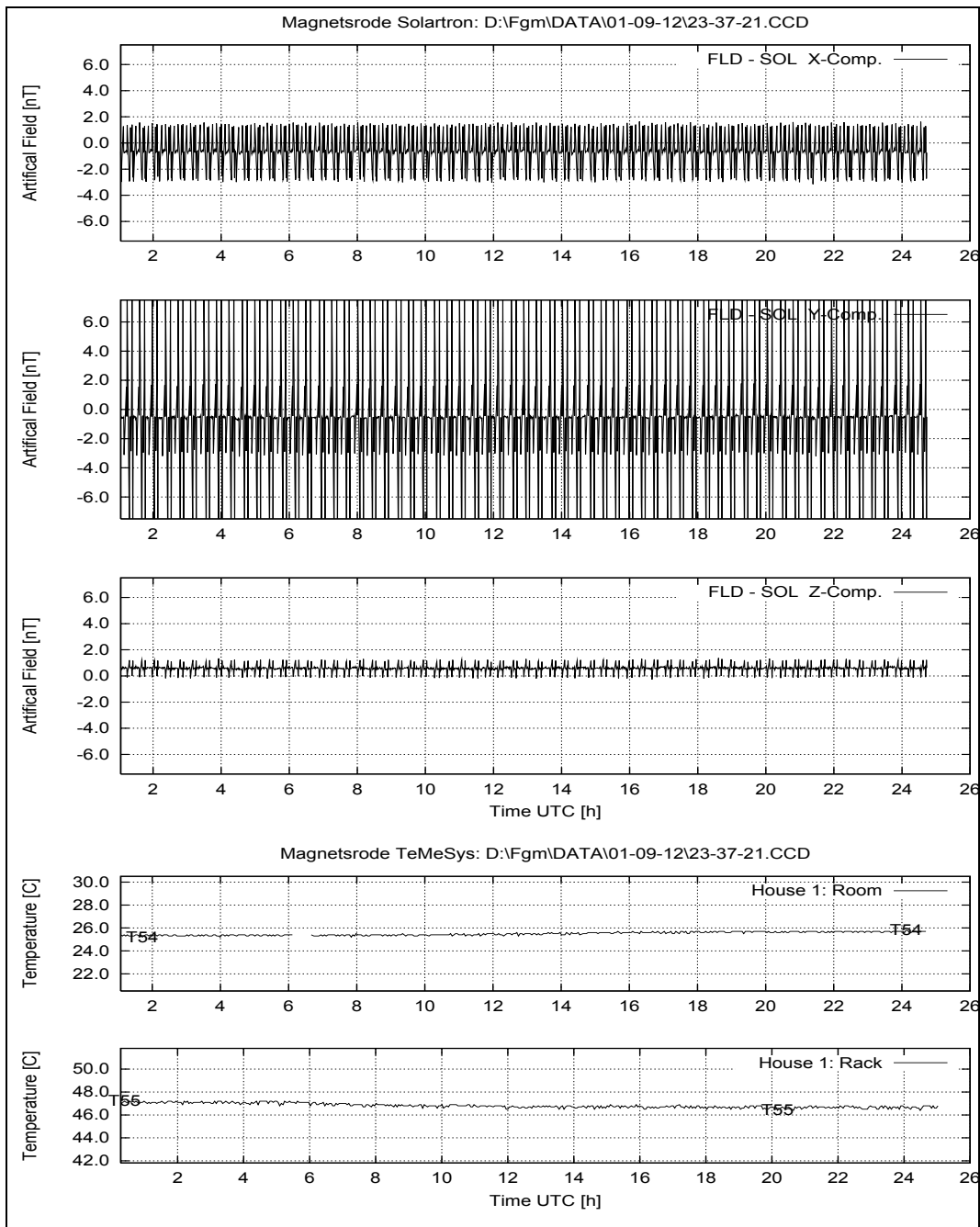

Figure 168: Sep. 12, 2001: System Performance: FLD – SOL; Temperatures House 1.

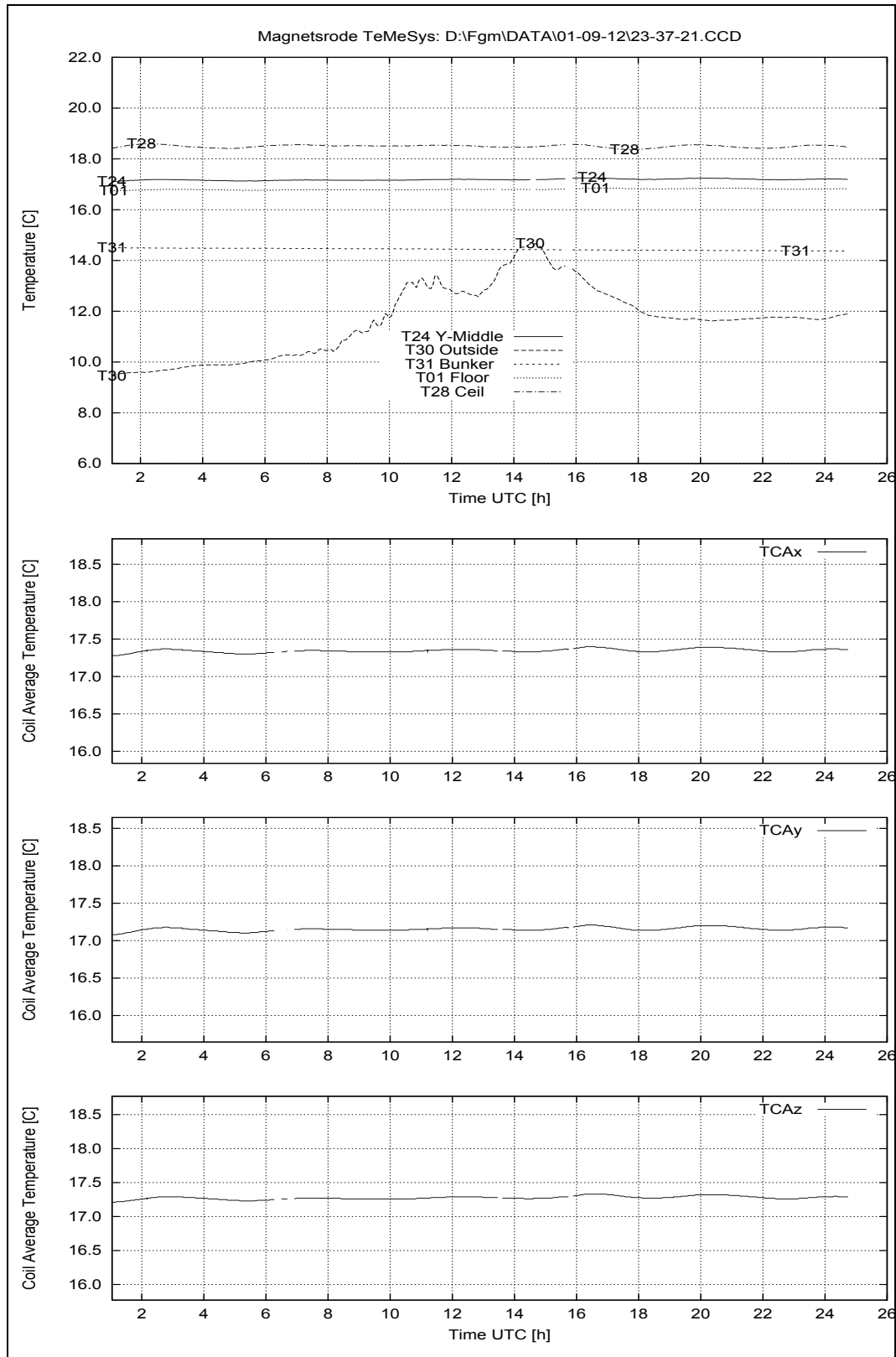

Figure 169: September 12, 2001: Temperatures House 2.

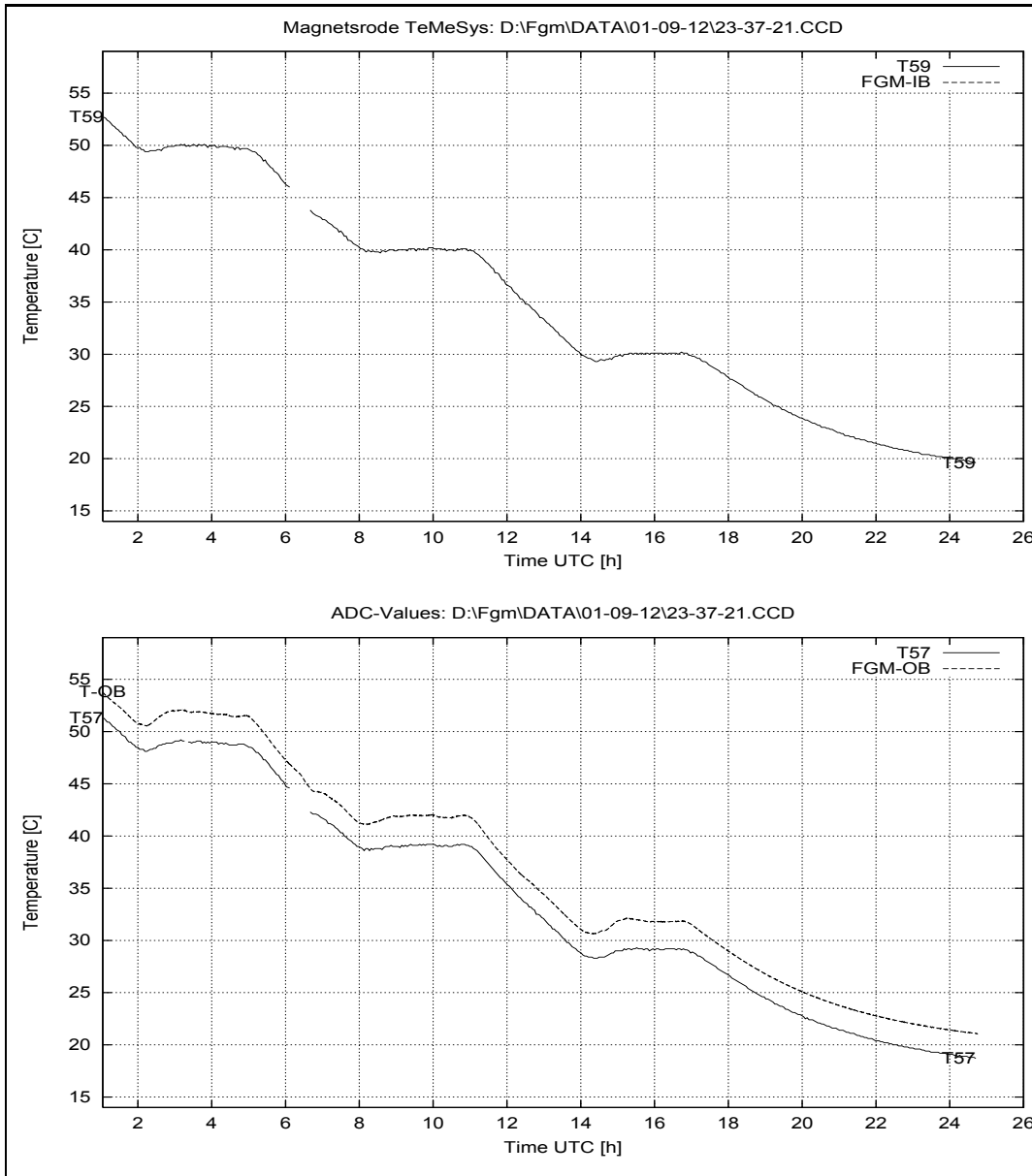

Figure 170: September 12, 2001: Sensor Temperatures at House 2.

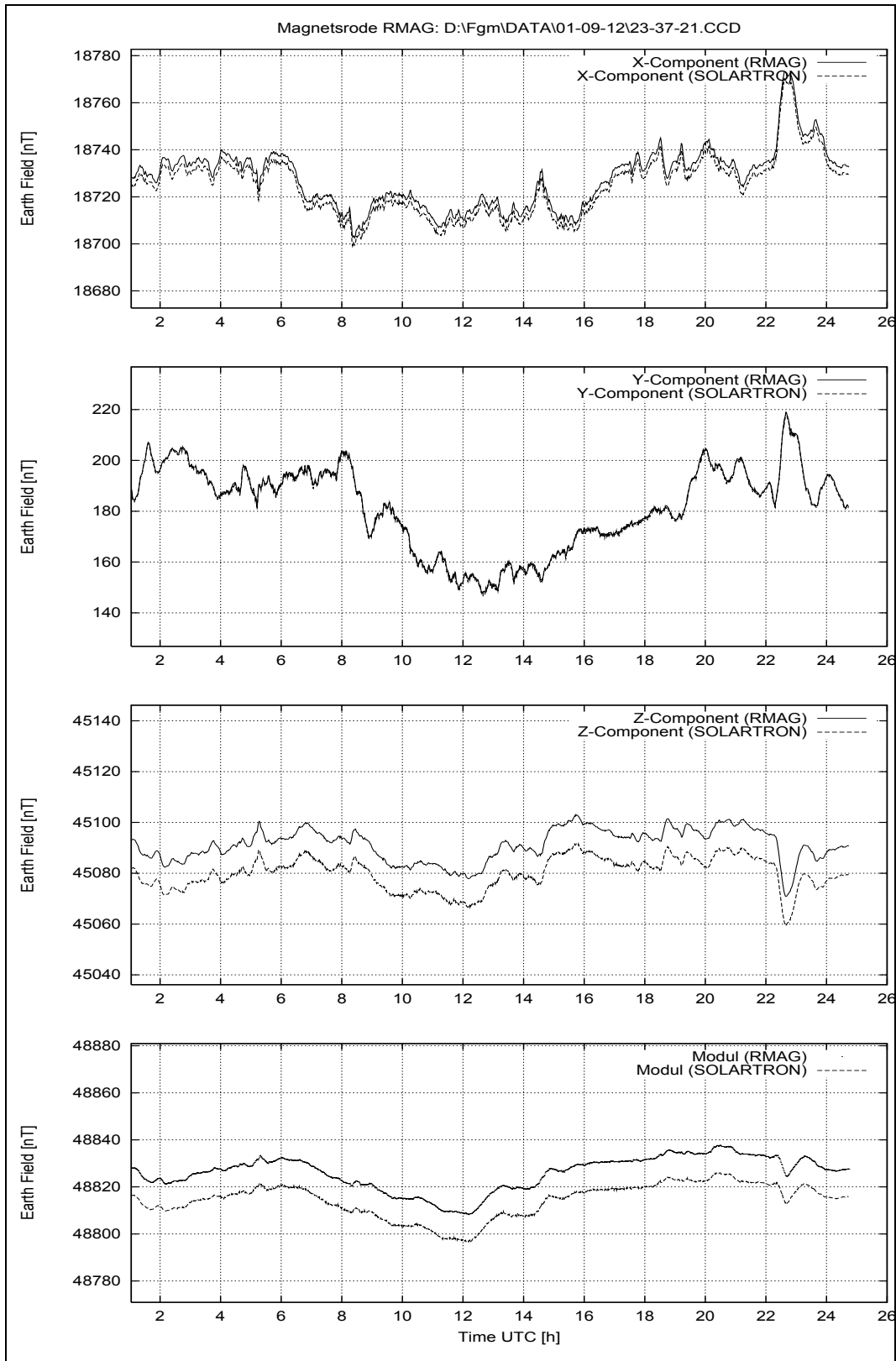

Figure 171: September 12, 2001: Earthfield variations.

R O S E T T A		Document: RO-IGM-TR-0002
		Issue: 2
		Revision: 2
IGM	Institut für Geophysik und Meteorologie Technische Universität Braunschweig	Date: October 10, 2001
		Page: 248

42 Thursday September 13, 2001

42.1 Temperature Calibration, Heating Cycle continued, DPU:FS, Sensors: FM

The heating cycle continued without until the early morning without any problems – finally.

42.1.1 Data

Configuration File	CCD File	Remark
TEMP.CFG	01-09-13\00_45_03.CCD	
TEMP.CFG	01-09-13\01_52_44.CCD	
TEMP.CFG	01-09-13\03_00_24.CCD	
TEMP.CFG	01-09-13\04_08_04.CCD	
TEMP.CFG	01-09-13\05_15_45.CCD	
TEMP.CFG	01-09-13\06_23_26.CCD	

ROSETTA calibration completed.

42.2 Overview Plots: System Performance, Temperatures and Earth-field Variations.

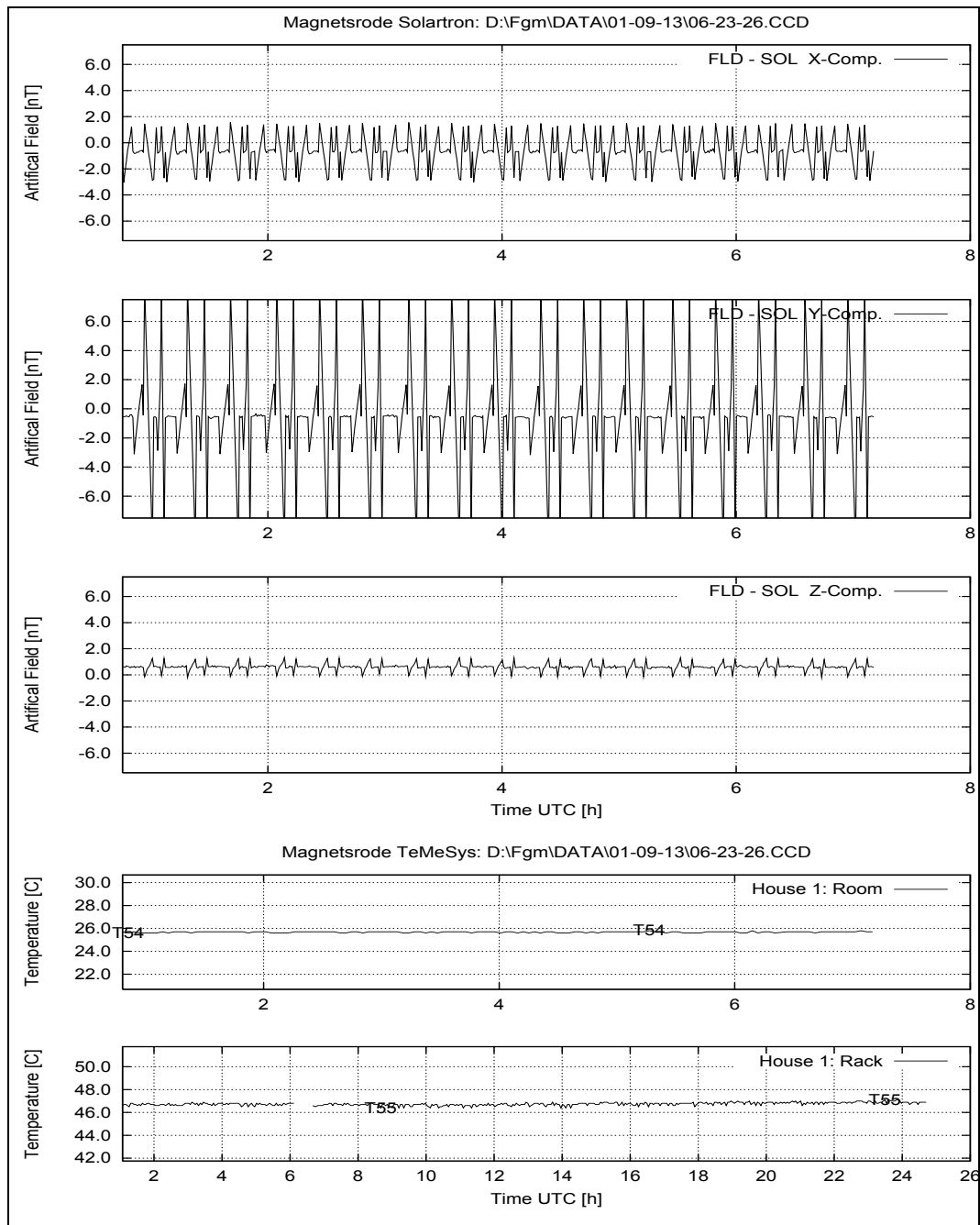

Figure 172: Sep. 13, 2001: System Performance: FLD – SOL; Temperatures House 1.

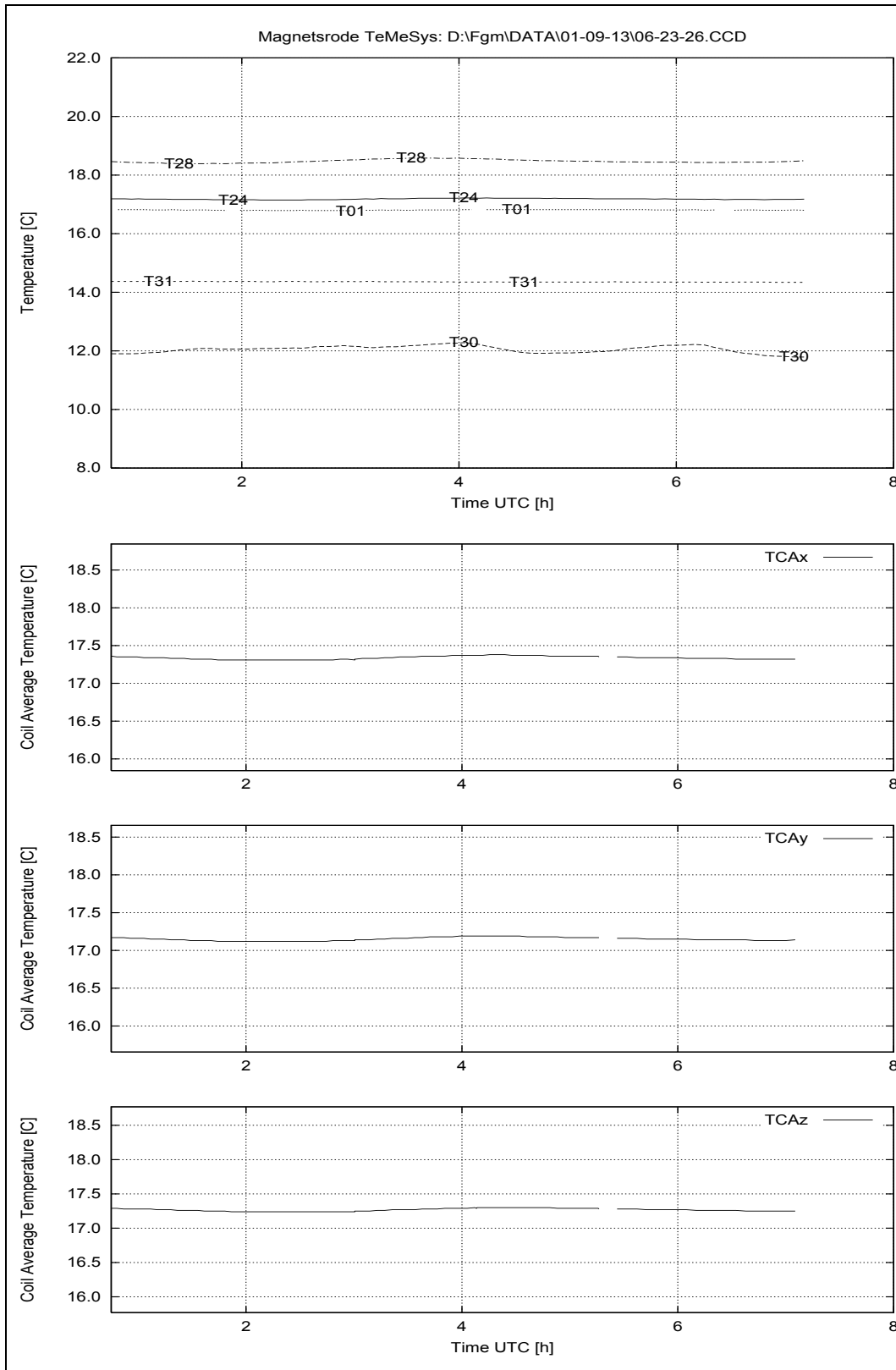

Figure 173: September 13, 2001: Temperatures House 2.

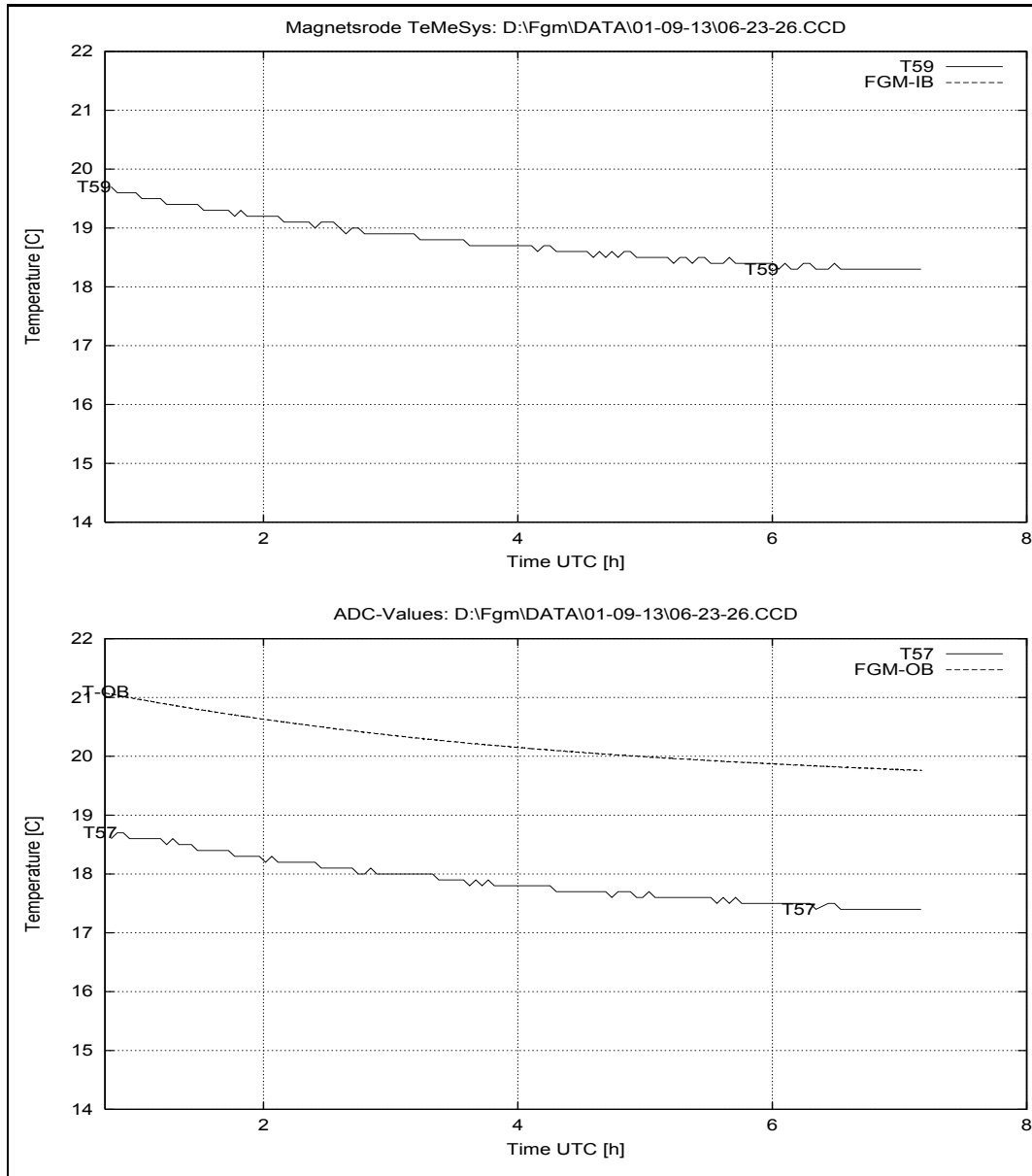

Figure 174: September 13, 2001: Sensor Temperatures at House 2.

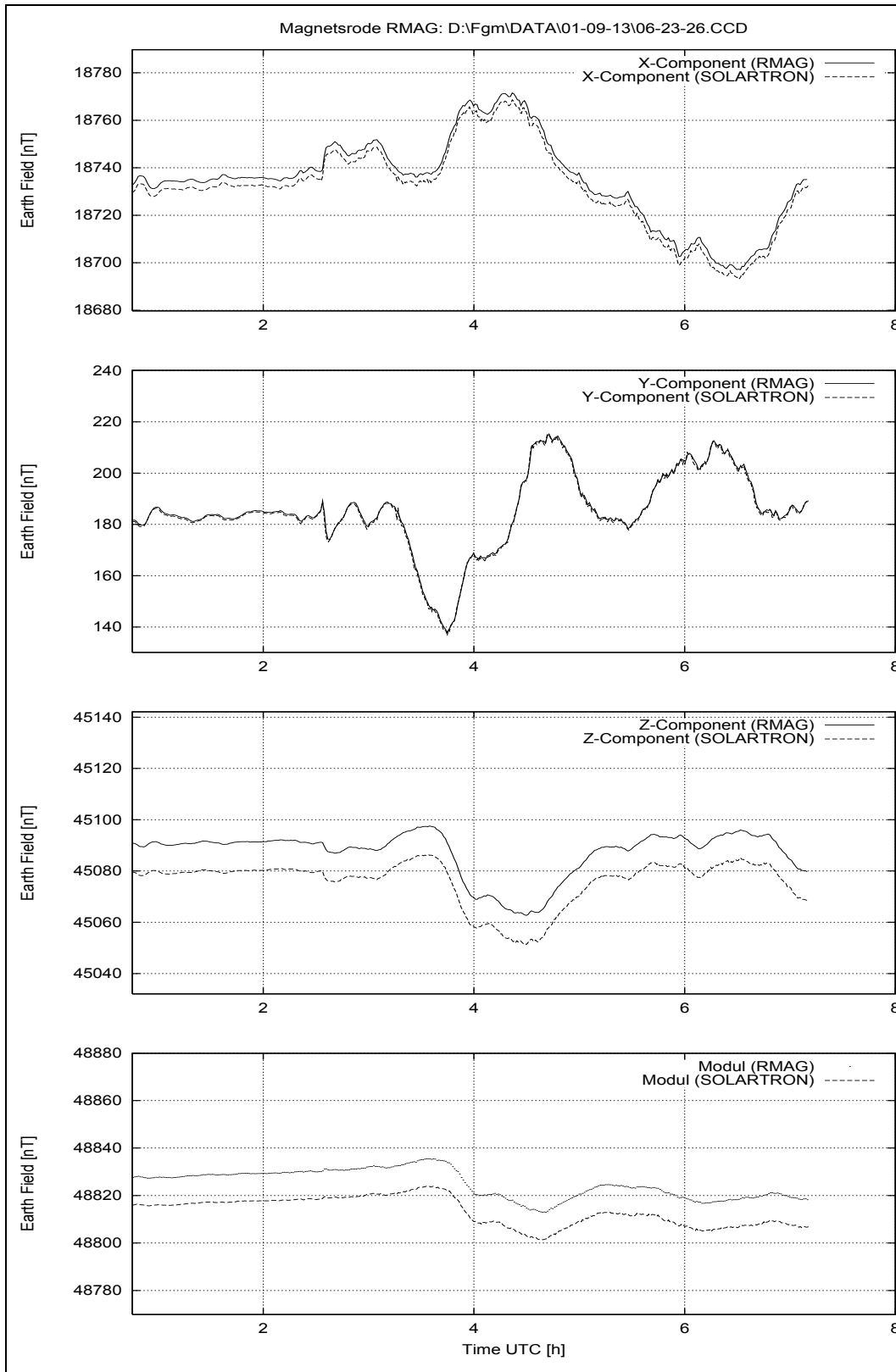

Figure 175: September 13, 2001: Earthfield variations.

43 The End

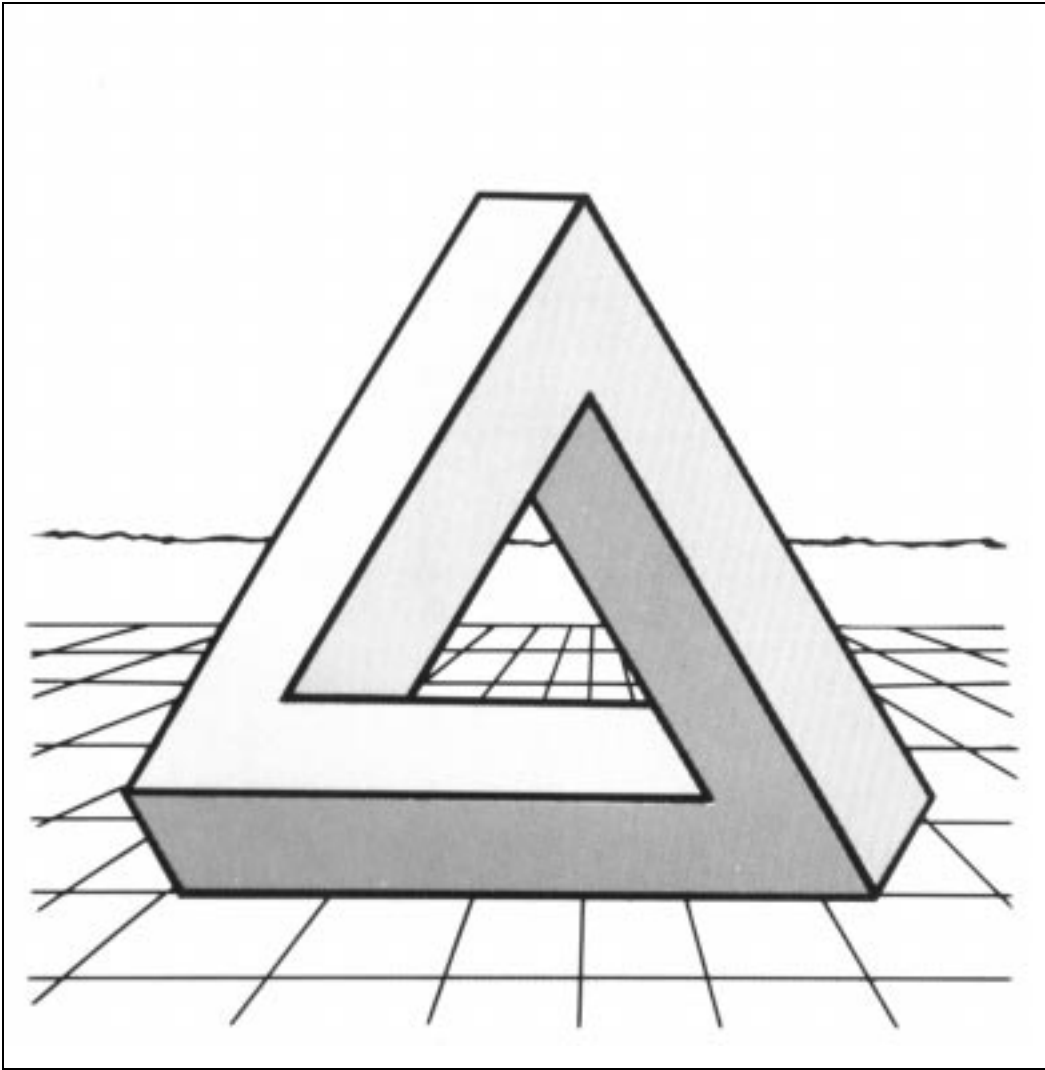

Figure 176: Going straight forward on the surface leads directly to perfect calibrations.

A Overview Plots

A.1 General Remarks

The overview plots for each day are produced using a lot of special batches and scripts after the data have been extracted from the *.CCD data files. The extraction was performed using the software CCD2T. This program extracts time series of a specific data type from the data files. Tables 6 and 7 shows some of the extraction setup topics. Especially the nominal averaging rates.

For the ROSETTA calibration the two different types of ADC frame within the *.CCD data files are of special interest. The ROSETTA specific data recording program ROSEterm records the digital data from the experiment as standard ADC frames using the ident ROSETTA.

Date / nom.Av.	RMAG	TEMA	TEMB	TCA	SOL	PROT	ADC (DT5816A)	ADC (ROSETTA)
	6	1	1	1	1	10	60	—
0308	6	1	1	1	1	10	60	—
0309	6	1	1	1	1	10	60	—
0310	6	1	1	1	1	10	60	—
0311	6	1	1	1	1	10	60	—
0312	6	1	1	1	1	10	60	—
0313	6	1	1	1	1	10	60	—
0314	6	1	1	1	1	10	60	—
0315	6	1	1	1	1	10	60	—
0316	6	1	1	1	1	10	60	—
0317	6	1	1	1	1	10	60	—
0318	6	1	1	1	1	10	60	—
0319	6	1	1	1	1	10	60	200
0320	6	1	1	1	1	10	60	200
0321	6	1	1	1	1	10	60	200
0322	6	1	1	1	1	10	60	200
0323	6	1	1	1	1	10	60	200
0324	6	1	1	1	1	10	60	200
0325	6	1	1	1	1	10	60	200
0326	6	1	1	1	1	10	60	200
0327	6	1	1	1	1	10	60	200
0328	6	1	1	1	1	10	60	200
0329	6	1	1	1	1	10	60	200
0405	6	1	1	1	1	10	60	200
0406	6	1	1	1	1	10	60	200

Table 6: Time series extraction list 1.

For PREMA, SOL, PROT and ADC some special setups are necessary for CCD2T. These parameters can only be set using the *Set Parameter* function of the program for extraction of this data type. After the setup has been performed the program should be terminated to save the actual configuration. Now *Set Parameter* can be called using a extraction list. The extraction lists are named RO_mmdd.EXT. They are created by the function *Prepare Extraction List* from CCD2T.

After the data have been extracted from the *.CCD files they have to be plotted. This is done using some batches to copy the data to standard names, call the plot program *GnuPlot* with an appropriate script and copy the plots back to specific names. The

Date / nom.Av.	RMAG	TEMA	TEMB	TCA	SOL	PROT	ADC (DT5816A)	ADC (ROSETTA)
0420	6	1	1	1	1	10	60	200
0421	6	1	1	1	1	10	60	200
0422	6	1	1	1	1	10	60	200
0423	6	1	1	1	1	10	60	200
0424	6	1	1	1	1	10	60	200
0425	6	1	1	1	1	10	60	200
0426	6	1	1	1	1	10	60	200
0427	6	1	1	1	1	10	60	200
0428	6	1	1	1	1	10	60	200
0429	6	1	1	1	1	10	60	200
0430	6	1	1	1	1	10	60	200
0501	6	1	1	1	1	10	60	200
0502	6	1	1	1	1	10	60	200
0828	6	1	1	1	1	10	60	200
0829	6	1	1	1	1	10	60	200
0830	6	1	1	1	1	10	60	200
0831	6	1	1	1	1	10	60	200
0901	6	1	1	1	1	10	60	200
0902	6	1	1	1	1	10	60	200
0903	6	1	1	1	1	10	60	200
0906	6	1	1	1	1	10	60	200
0907	6	1	1	1	1	10	60	200
0908	6	1	1	1	1	10	60	200
0909	6	1	1	1	1	10	60	200
0910	6	1	1	1	1	10	60	200
0911	6	1	1	1	1	10	60	200
0912	6	1	1	1	1	10	60	200
0913	6	1	1	1	1	10	60	200

Table 7: Time series extraction list 2.

following table A.1 lists the names of the plot files, the batches, scripts and the nominal vertical size parameter. The abbreviation `mmdd` will be filled with two digits month and day.

Overview	Files	Batch	Script	Size
1	FDAmddX.EPS	SOLDELTA.BAT	SOLDELTA.INI	0.50
	FDAmddY.EPS	SOLDELTA.BAT	SOLDELTA.INI	0.50
	FDAmddZ.EPS	SOLDELTA.BAT	SOLDELTA.INI	0.50
	TmmddG.EPS	Temp_HS1.BAT	Temp_HS2.INI	0.35
	TmmddH.EPS	Temp_HS1.BAT	Temp_HS2.INI	0.35
2	TmmddA.EPS	Temp_ROS.BAT	Temp_ROS.INI	1.00
	TmmddB.EPS	Temp_ROS.BAT	Temp_ROS.INI	0.55
	TmmddC.EPS	Temp_ROS.BAT	Temp_ROS.INI	0.55
	TmmddD.EPS	Temp_ROS.BAT	Temp_ROS.INI	0.55
3	TmmddI.EPS	Temp_R02.BAT	Temp_R02.INI	1.00
	TmmddO.EPS	Temp_R02.BAT	Temp_R02.INI	1.00
4	Rmmdd00.EPS	RMAGSOL.BAT	RMAGSOL.INI	0.66
	Rmmdd01.EPS	RMAGSOL.BAT	RMAGSOL.INI	0.66
	Rmmdd02.EPS	RMAGSOL.BAT	RMAGSOL.INI	0.66
	Rmmddb02.EPS	RMAGPROT.BAT	RMAGPROT.INI	0.66
special	Zmmdd00.EPS	STABREP.BAT	STABREP.INI	0.66
	Zmmdd01.EPS	STABREP.BAT	STABREP.INI	0.66
	Zmmdd02.EPS	STABREP.BAT	STABREP.INI	0.66
	Zmmddb02.EPS	STABREP.BAT	STABREP.INI	0.66

Table 8: Batches and scripts to produce the overview plots types 1 to 4. The figures 136, 137, 138 and 139 (the first at page 202) are examples for these types. The Sensor Temperature Plots (figure 138, page 204) are of special interest for the Temperature Calibration Cycles. The special type is only used for documenting the stability measurement from March 3rd to March 19th. For an example see the plots starting page 260.

R O S E T T A		Document: RO-IGM-TR-0002
		Issue: 2
		Revision: 2
IGM	Institut für Geophysik und Meteorologie	Date: October 10, 2001
	Technische Universität Braunschweig	Page: 257

A.2 Remarks on Calibration Specials

A.2.1 System Performance, the FLD–SOL Problem

Due to the fact that the data are recorded on `*.CCR` files to be transformed to real `*.CCD` files off line, which is necessary for calculating the FLD–Frames from the SOLARTRON readings, the original FLD–Frames are lost. The calculation of the system performance (this is symbolic written as FLD–SOL) is no longer possible on the `*.CCD` files. This calculation has to be performed on the original recorded data `*.CCR`. So the batch `SOLDELTA.BAT` should be called using the SOLARTRON measurement time series data extracted from the `*.CCR` files. They have to be extracted from the archive files `YYMMDDr.ZIP`. To extract the time series from those files (`*.CCR`) they have to be renamed do `*.CCD`. All this was done preparing this document.

R O S E T T A		Document: RO-IGM-TR-0002
		Issue: 2
		Revision: 2
IGM	Institut für Geophysik und Meteorologie	Date: October 10, 2001
	Technische Universität Braunschweig	Page: 258

B Stability Measurements

Prior to all the calibration measurements the system zero field stability was investigated.

B.1 Setup

During a long period only zero fields are applied in one minute measurement steps. One run lasts about 1 hour. The zero field was measured using the so called ZopfMag, which is the coil system reference magnetometer, in the high resolution range (1 nT/mV). The vector rate was set to 1 Hz. For the following plot 60 vectors are averaged so the resulting "dot rate" is approximately 1 per minute.

The ZopfMag was placed in the center of the coil system. See the following picture to get an impression of the mechanical setup.

In the following day by day the standard overview plots (see B.2 at page 259) are shown. In addition the second plot on all the days show the zero field measurements from the ZopfMag. There was no offset measurement available, therefore the offset of the ZopfMag is *not* compensated. The fields measured are the offset plus the residual field from the system.

B.2 Thursday March 8, 2001

B.2.1 Overview Plots: System Performance, Temperatures and Earthfield Variations.

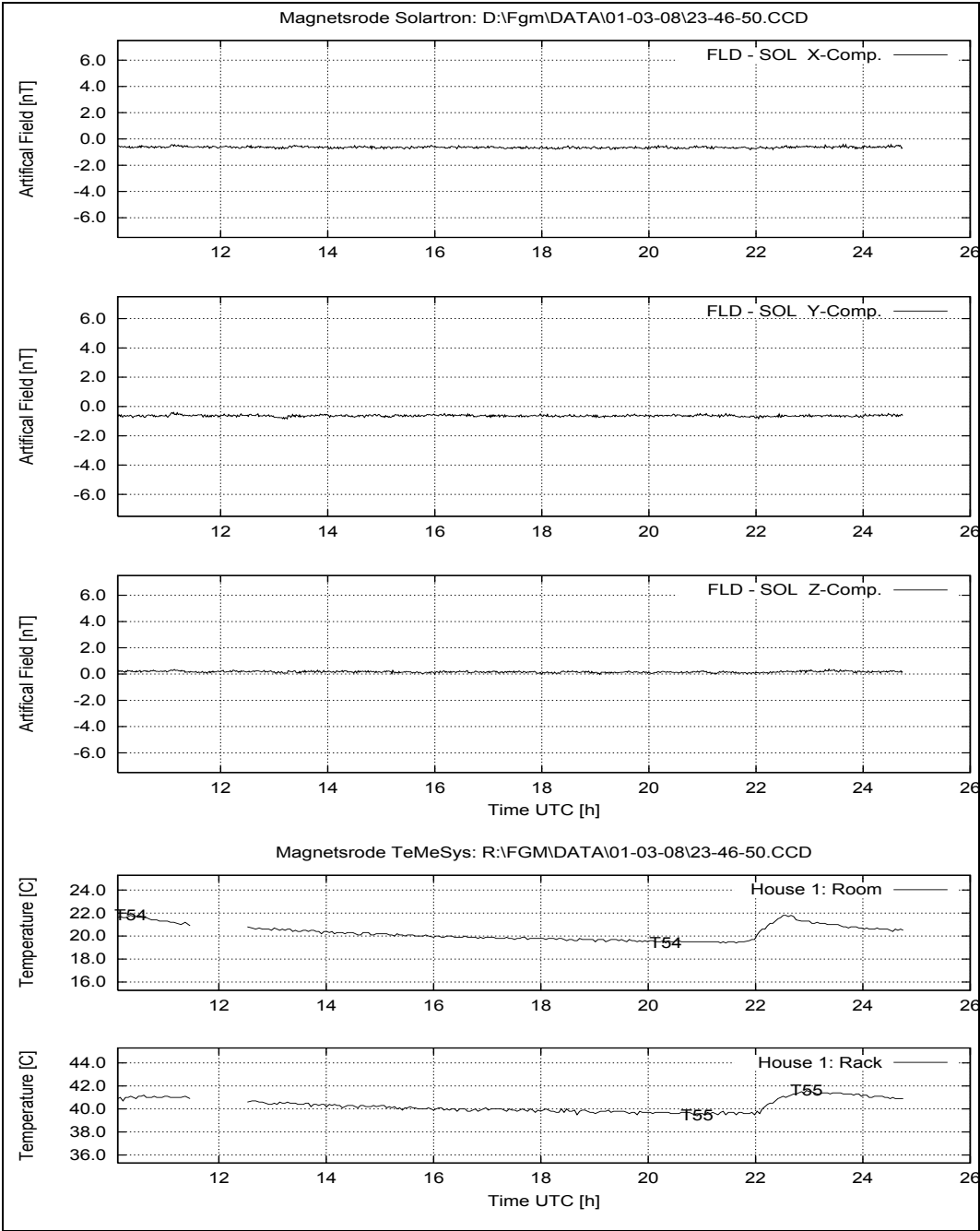

Figure 177: March 8, 2001: System Performance: FLD – SOL; Temperatures at House 1.

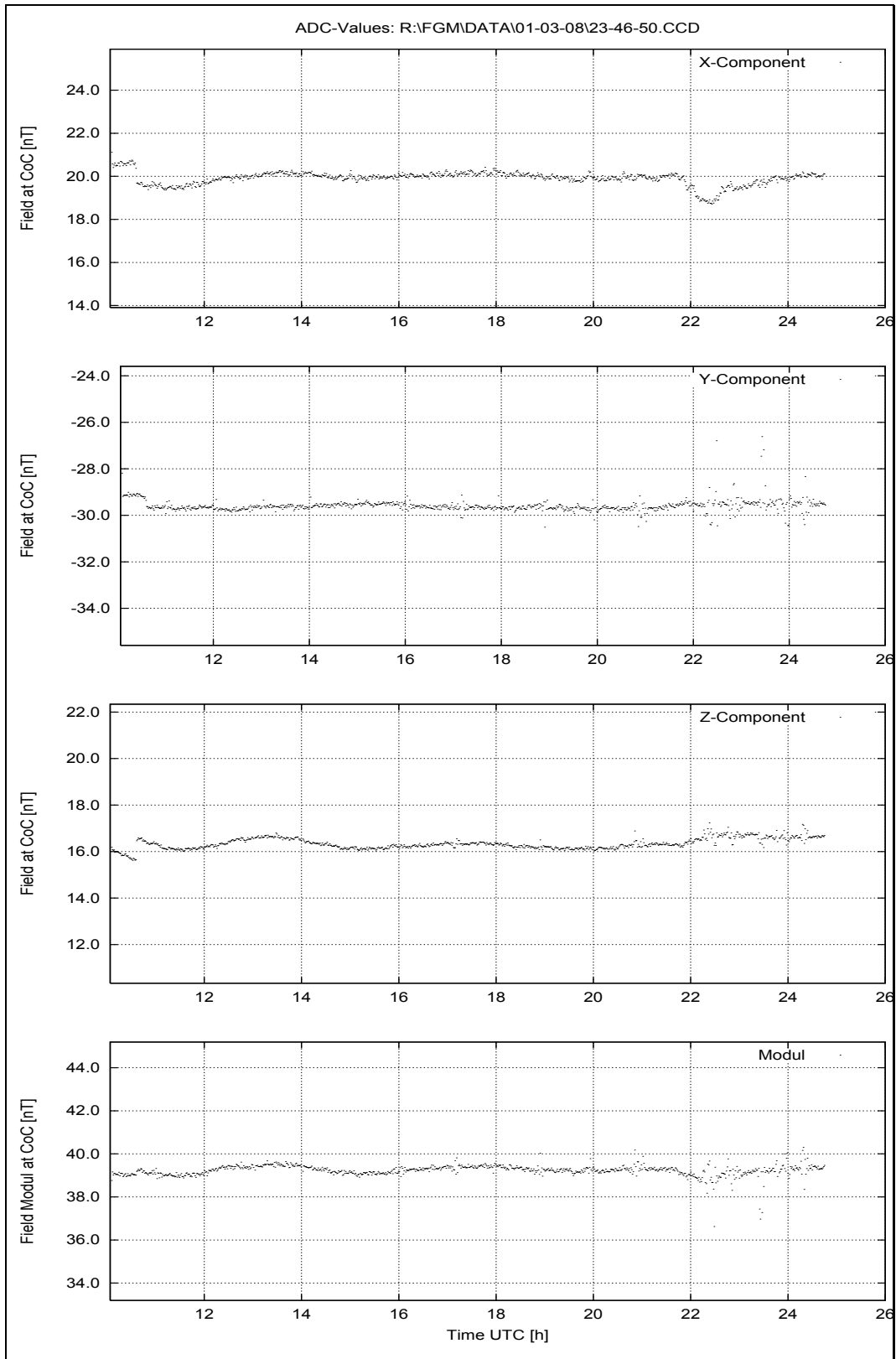

Figure 178: March 8, 2001: Zero field at CoC.

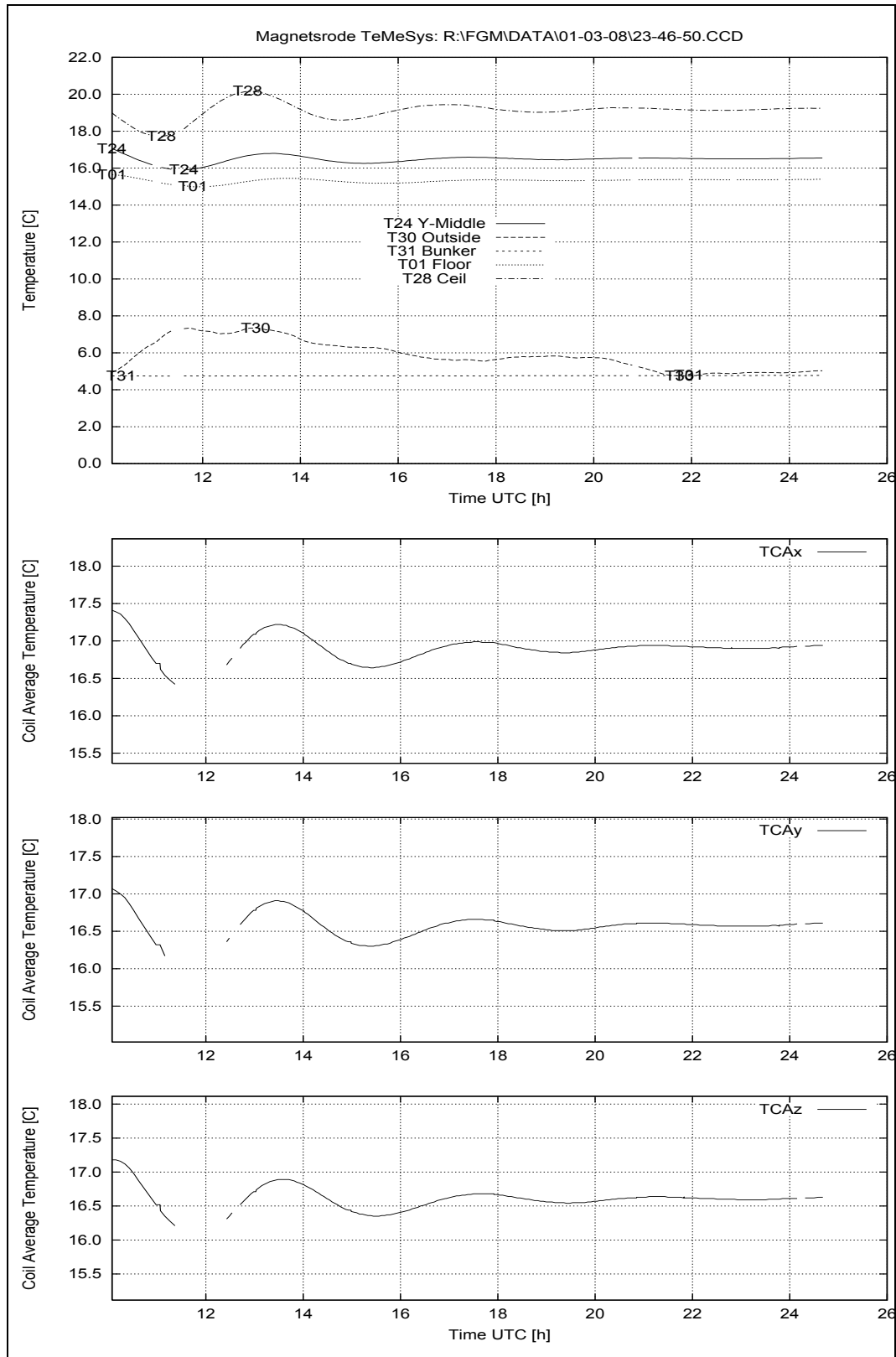

Figure 179: March 8, 2001: Temperatures House 2.

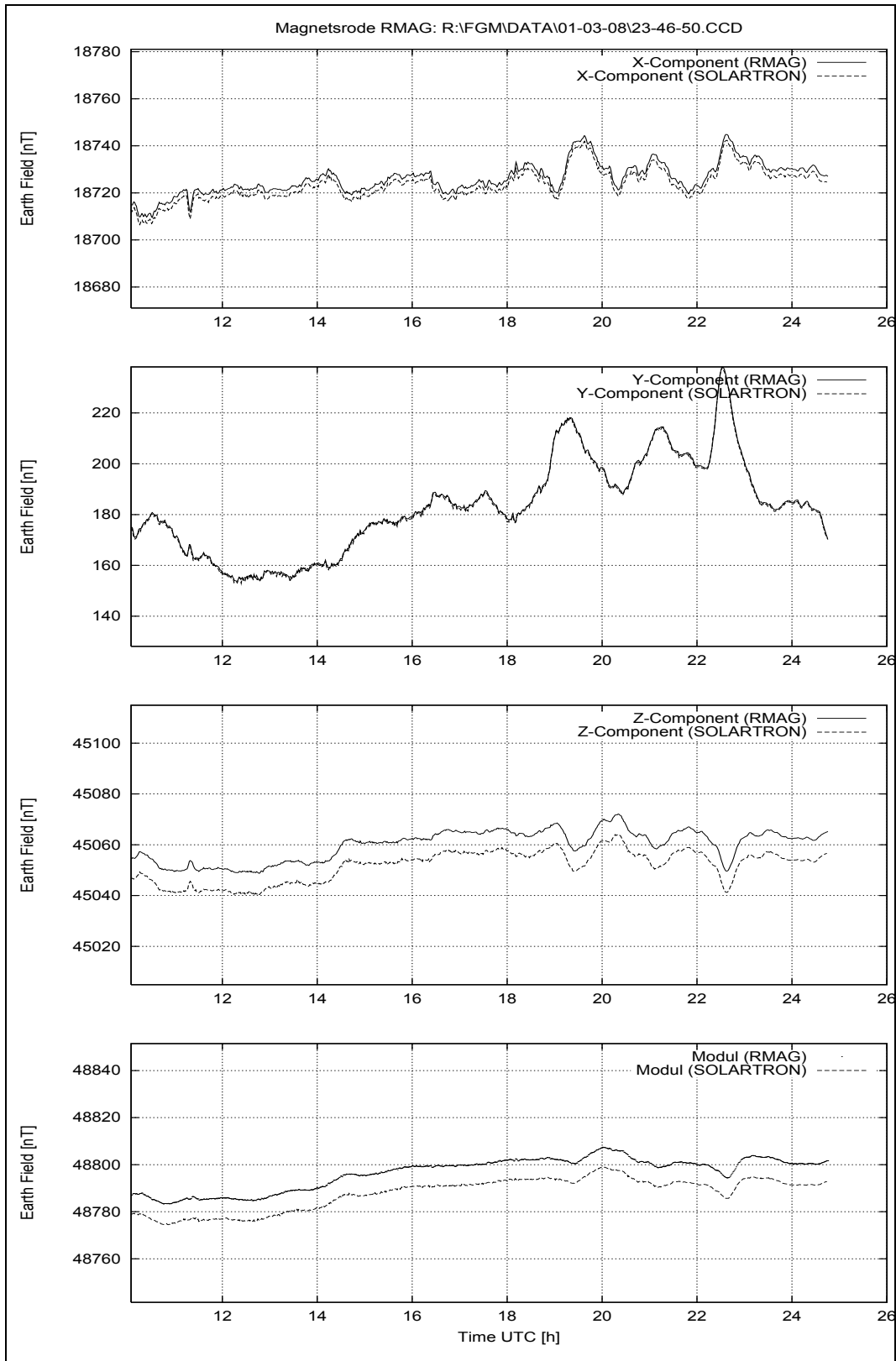

Figure 180: March 8, 2001: Earth field variations.

B.3 Friday March 9, 2001

B.3.1 Overview Plots: System Performance, Temperatures and Earthfield Variations.

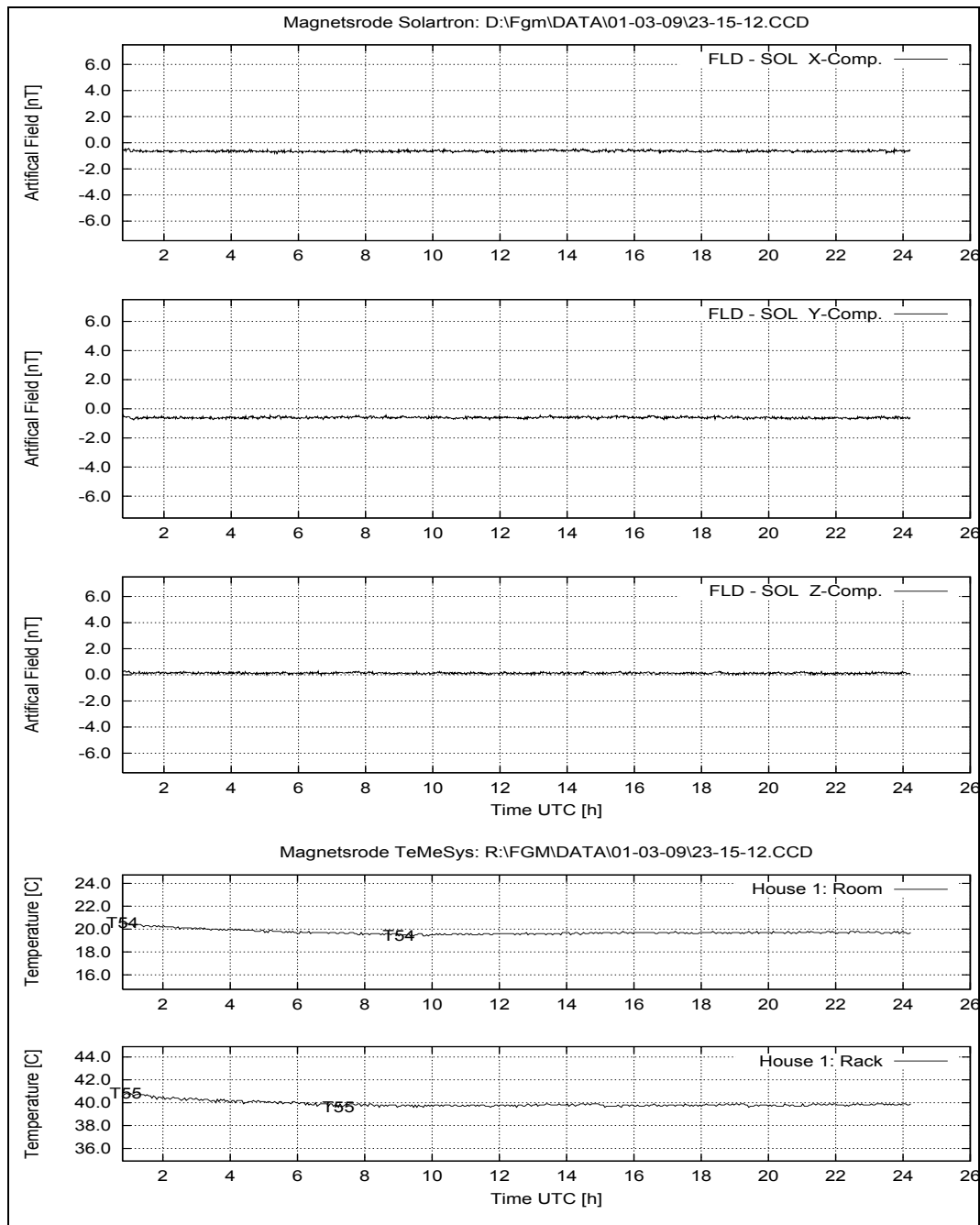

Figure 181: March 9, 2001: System Performance: FLD – SOL; Temperatures at House 1.

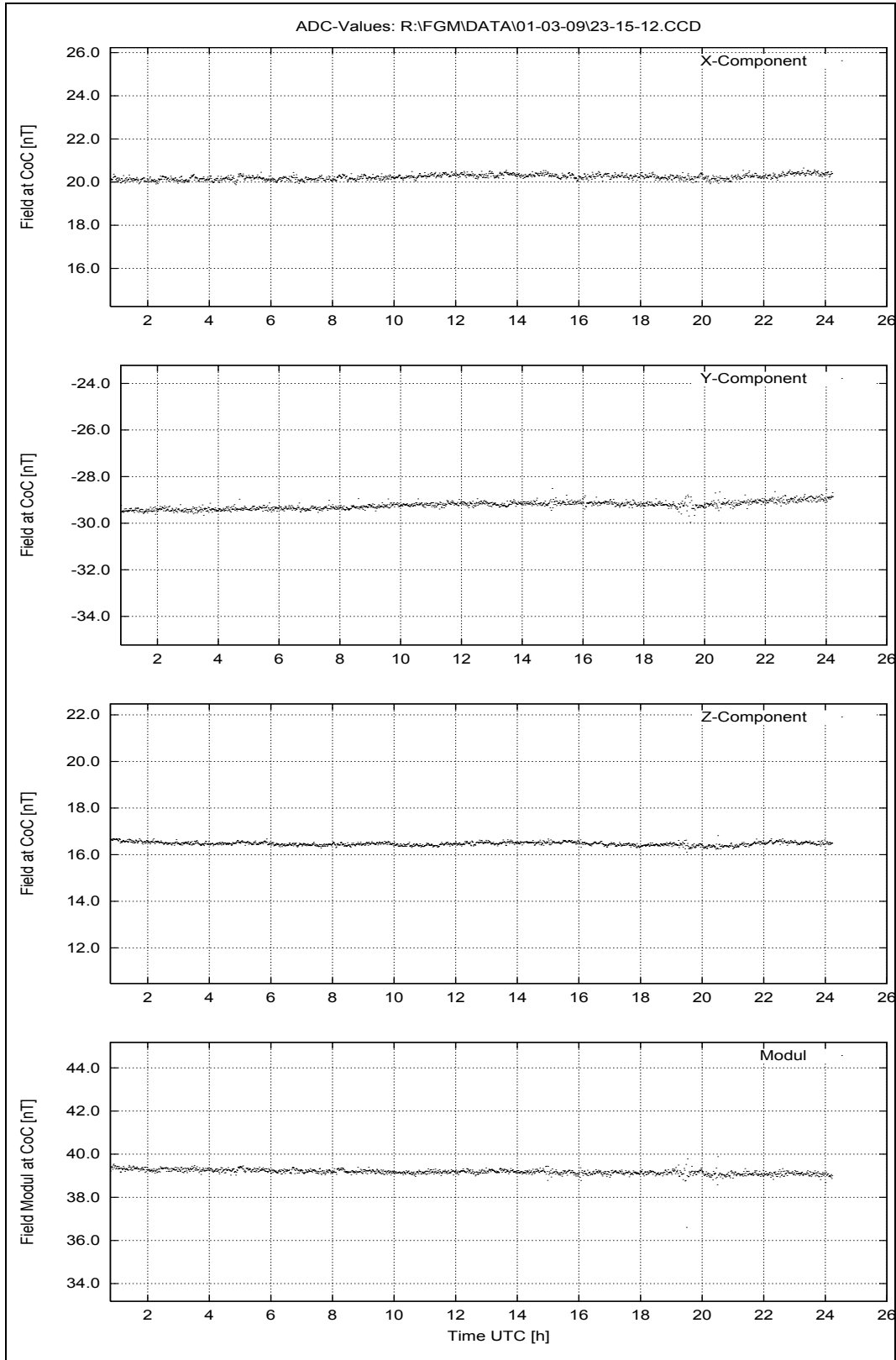

Figure 182: March 9, 2001: Zero field at CoC.

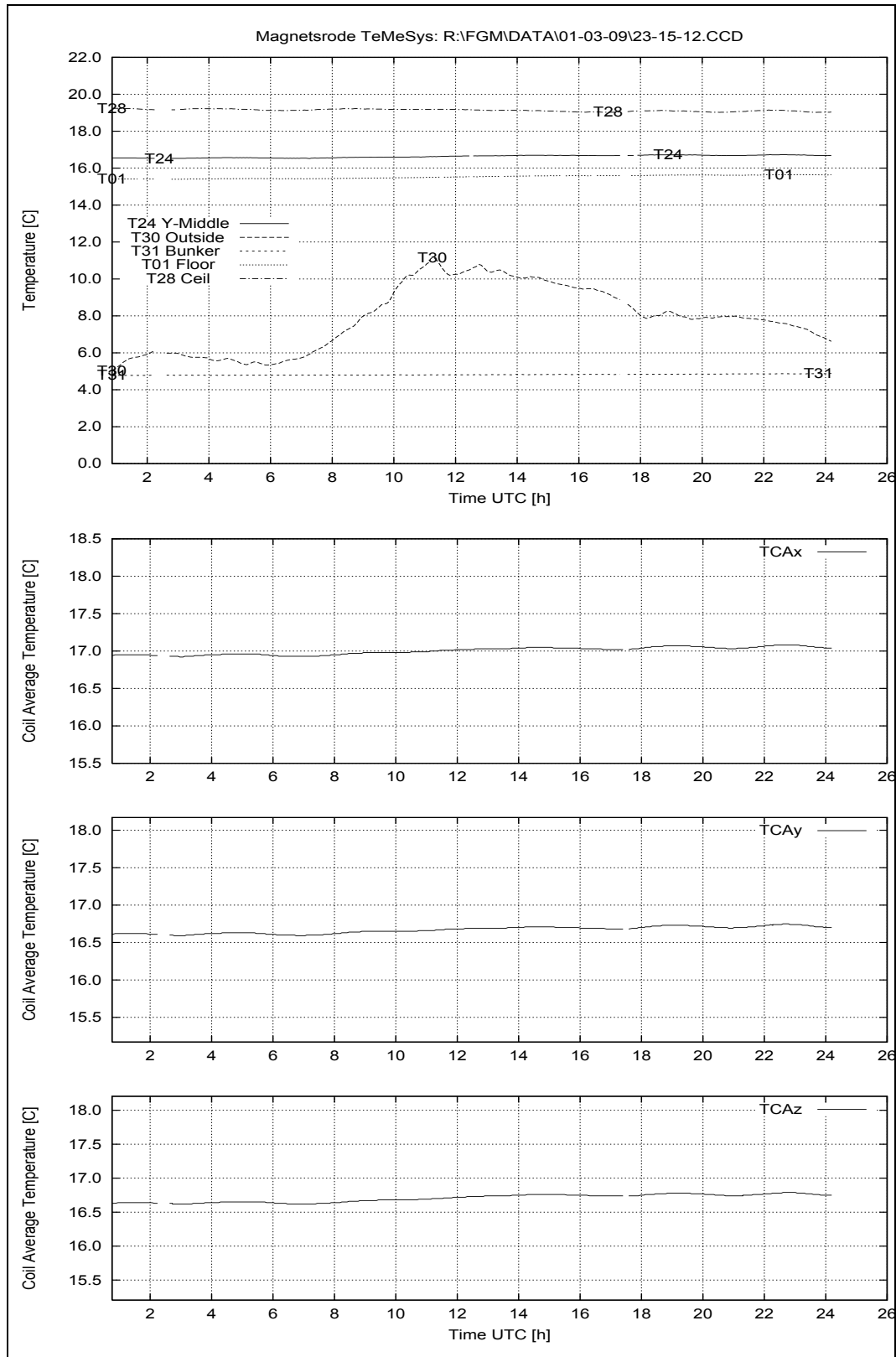

Figure 183: March 9, 2001: Temperatures House 2.

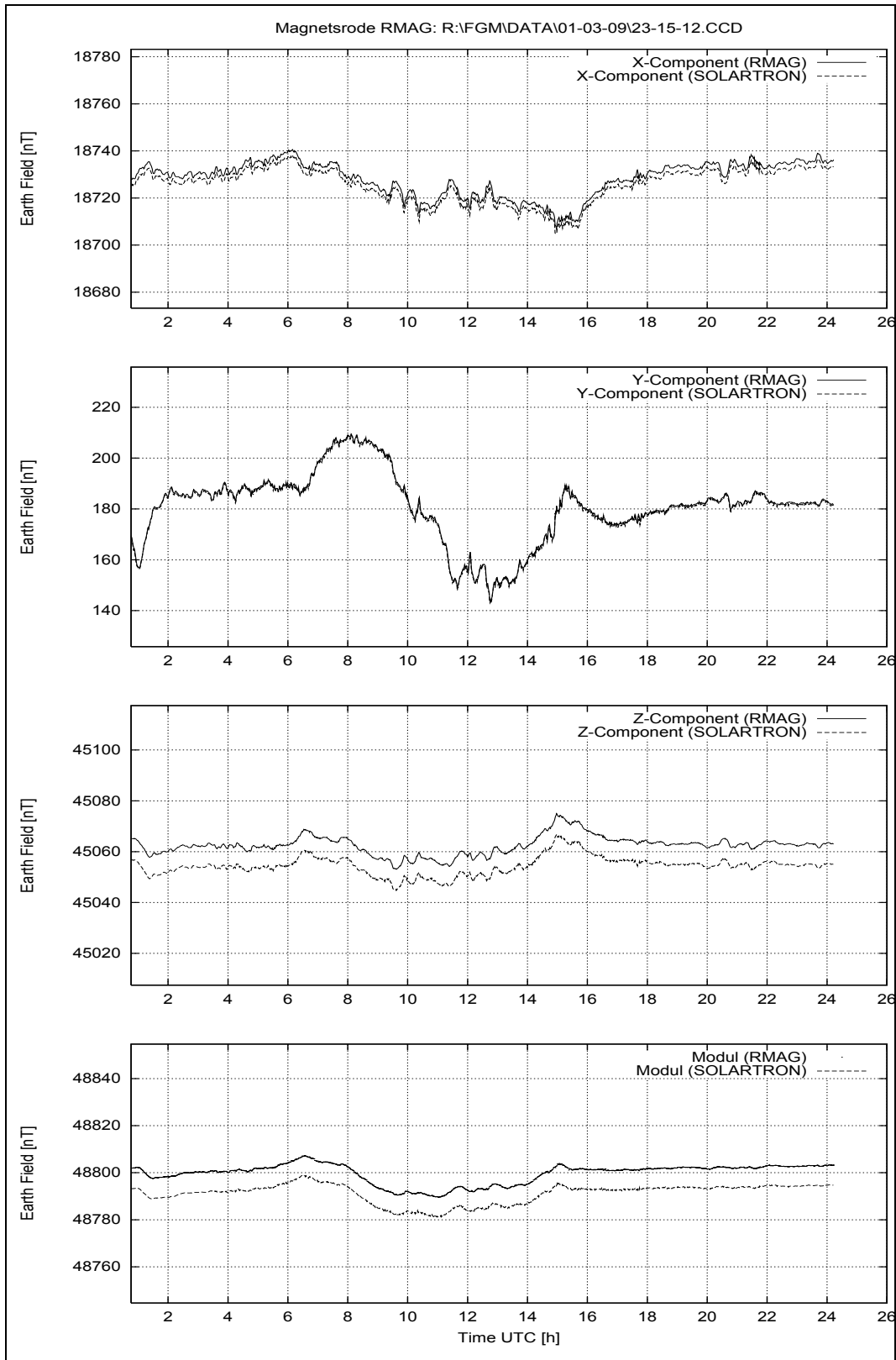

Figure 184: March 9, 2001: Earthfield variations.

B.4 Saturday March 10, 2001

B.4.1 Overview Plots: System Performance, Temperatures and Earthfield Variations.

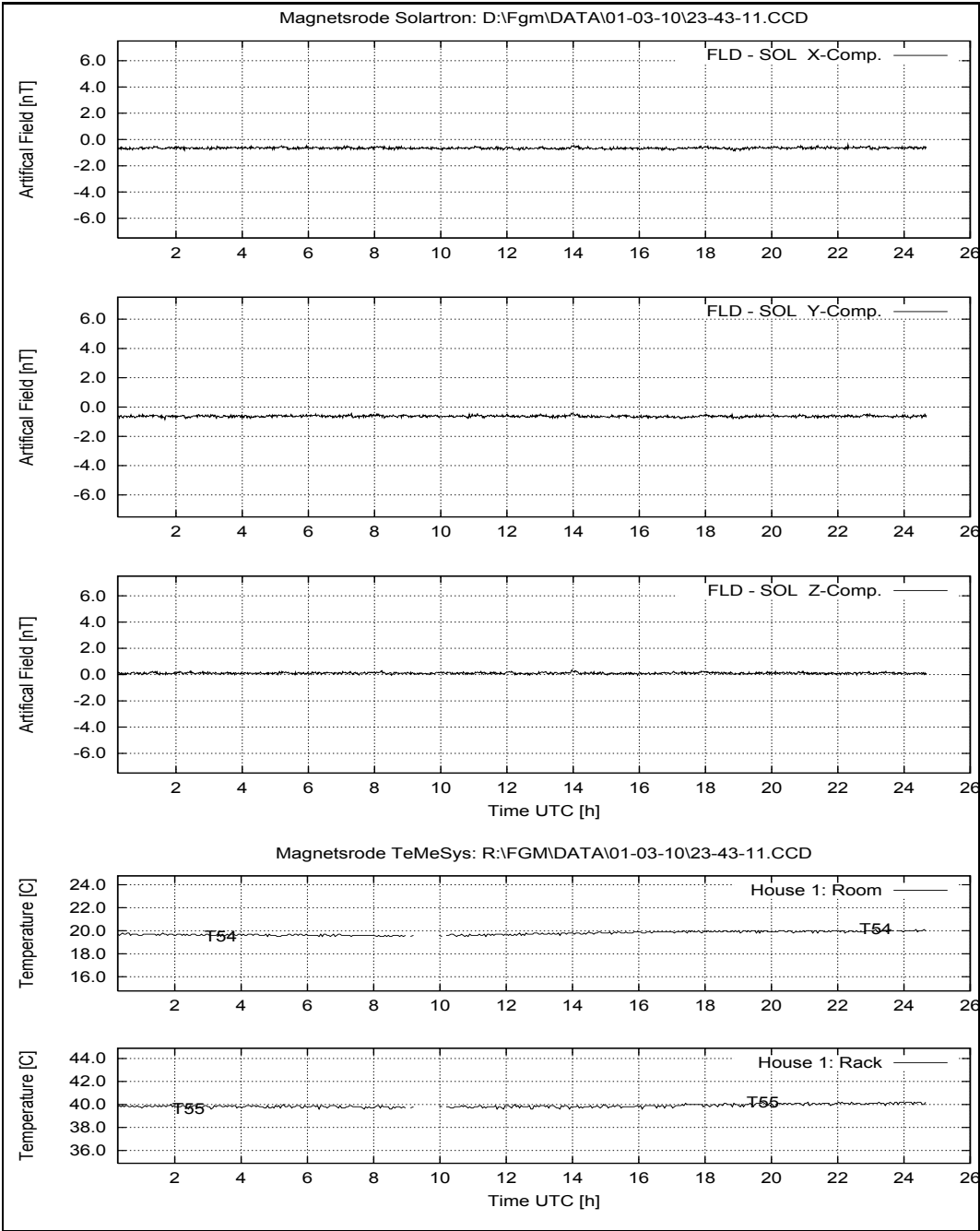

Figure 185: March 10, 2001: System Performance: FLD – SOL; Temperatures at House 1.

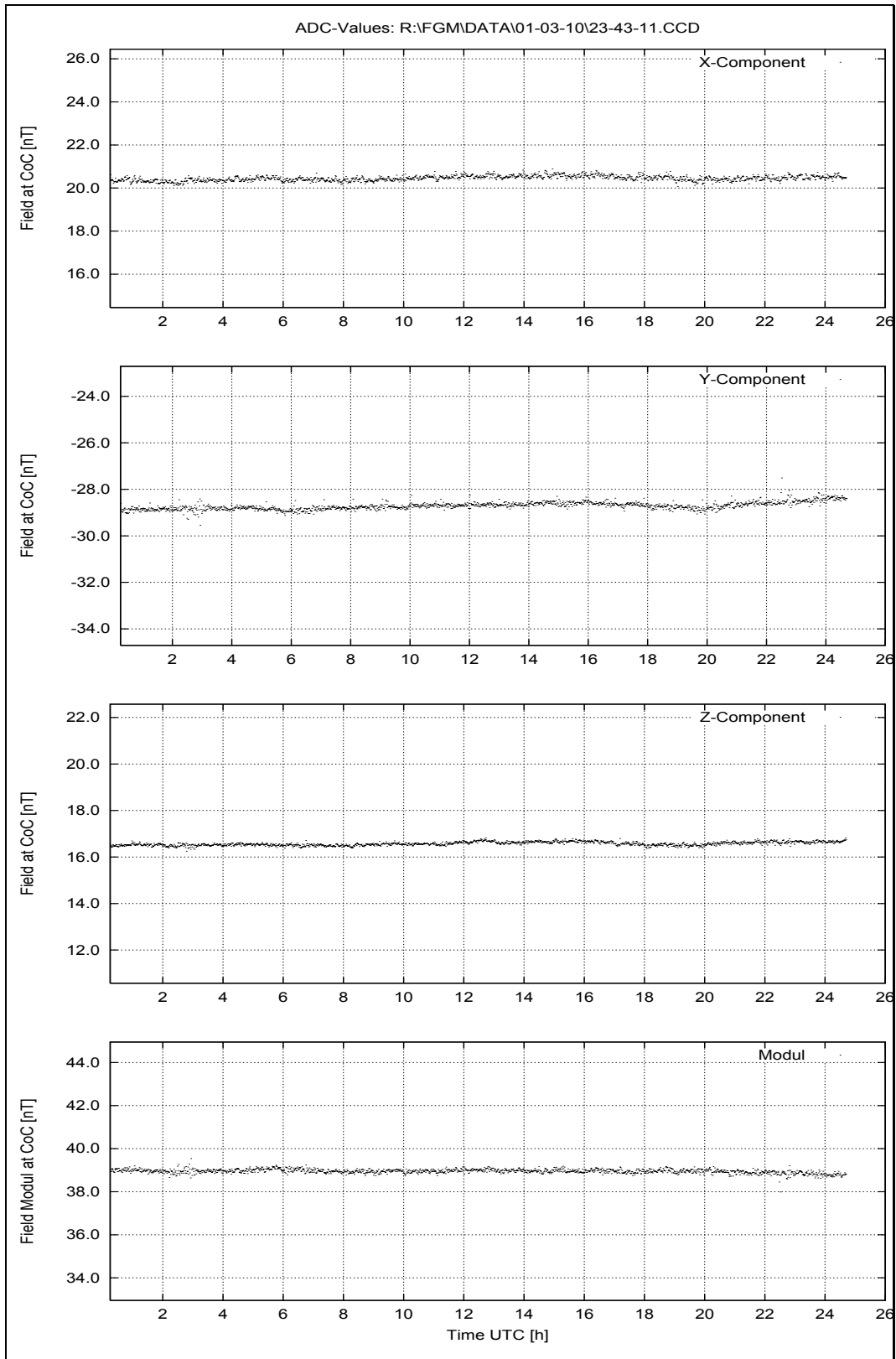

Figure 186: March 10, 2001: Zero field at CoC.

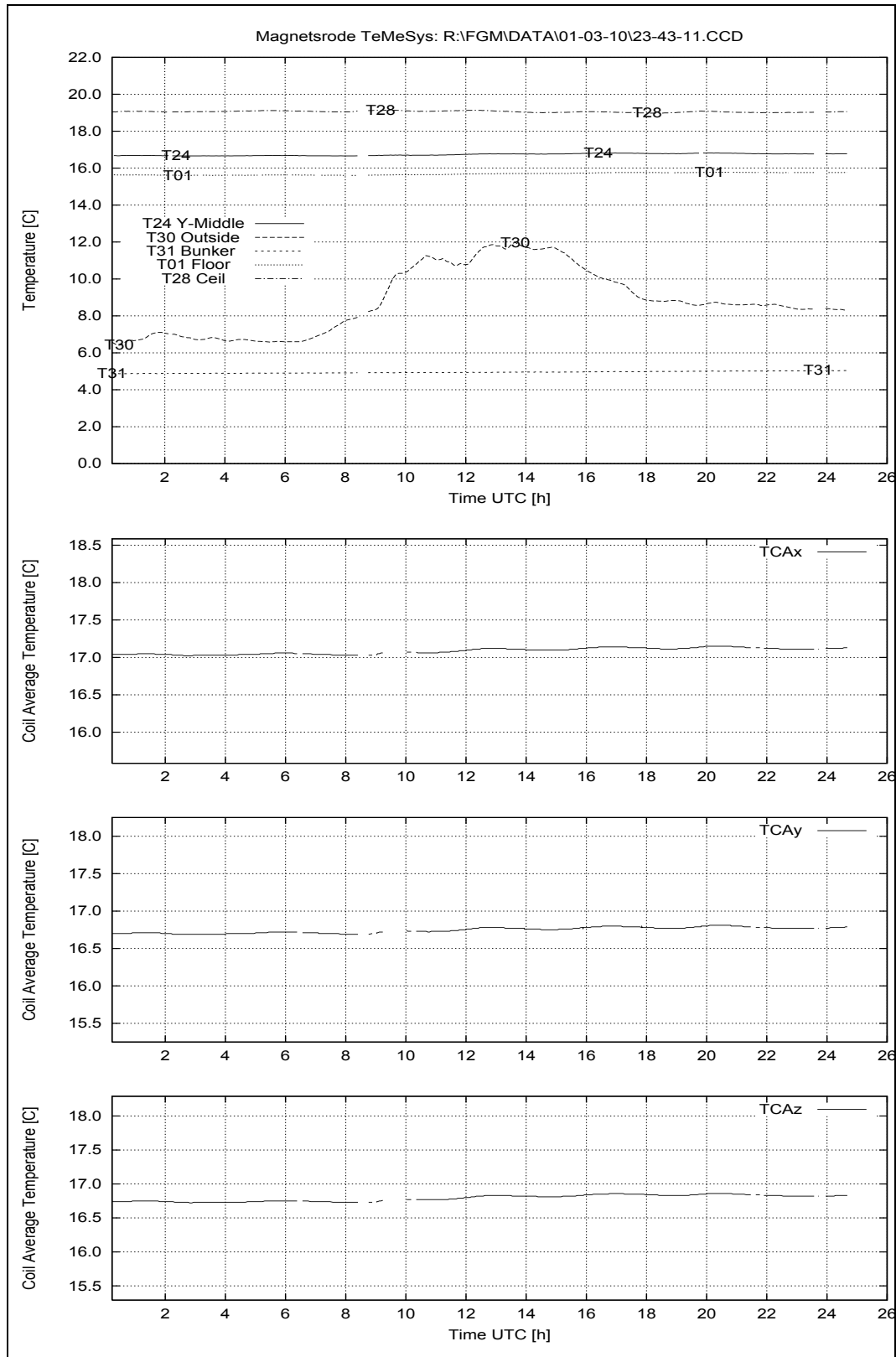

Figure 187: March 10, 2001: Temperatures House 2.

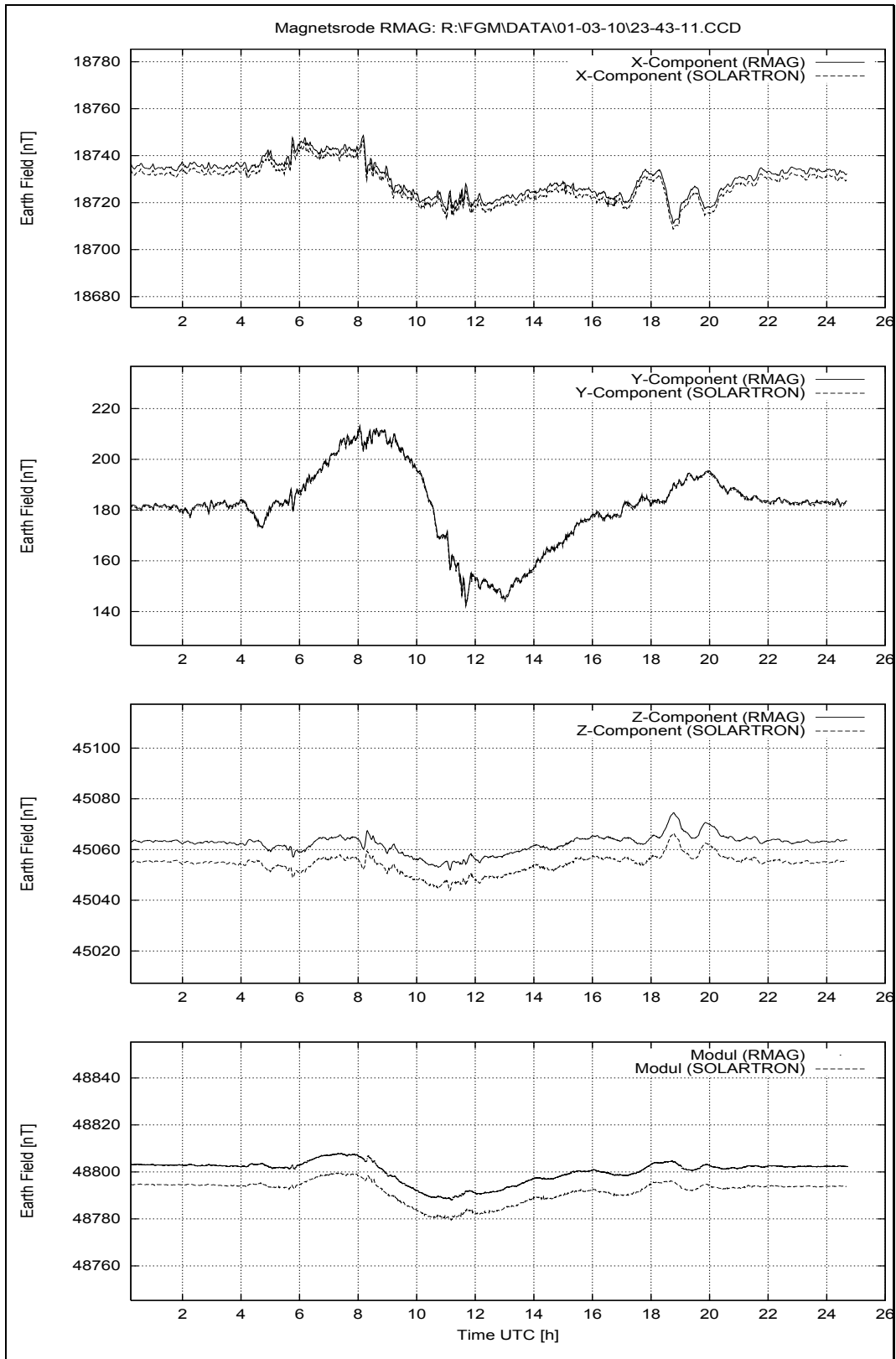

Figure 188: March 10, 2001: Earthfield variations.

B.5 Sunday March 11, 2001

B.5.1 Overview Plots: System Performance, Temperatures and Earthfield Variations.

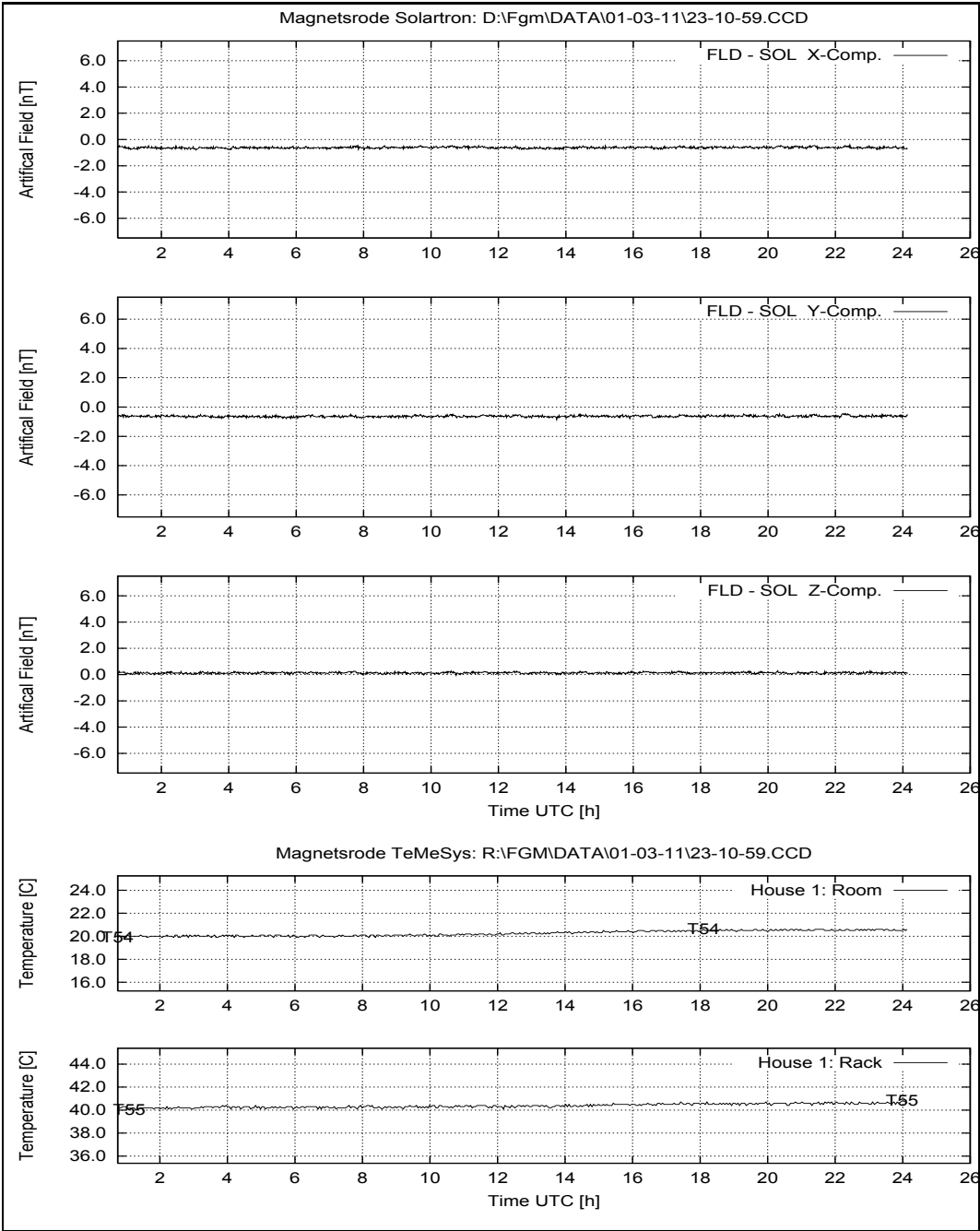

Figure 189: March 11, 2001: System Performance: FLD – SOL; Temperatures at House 1.

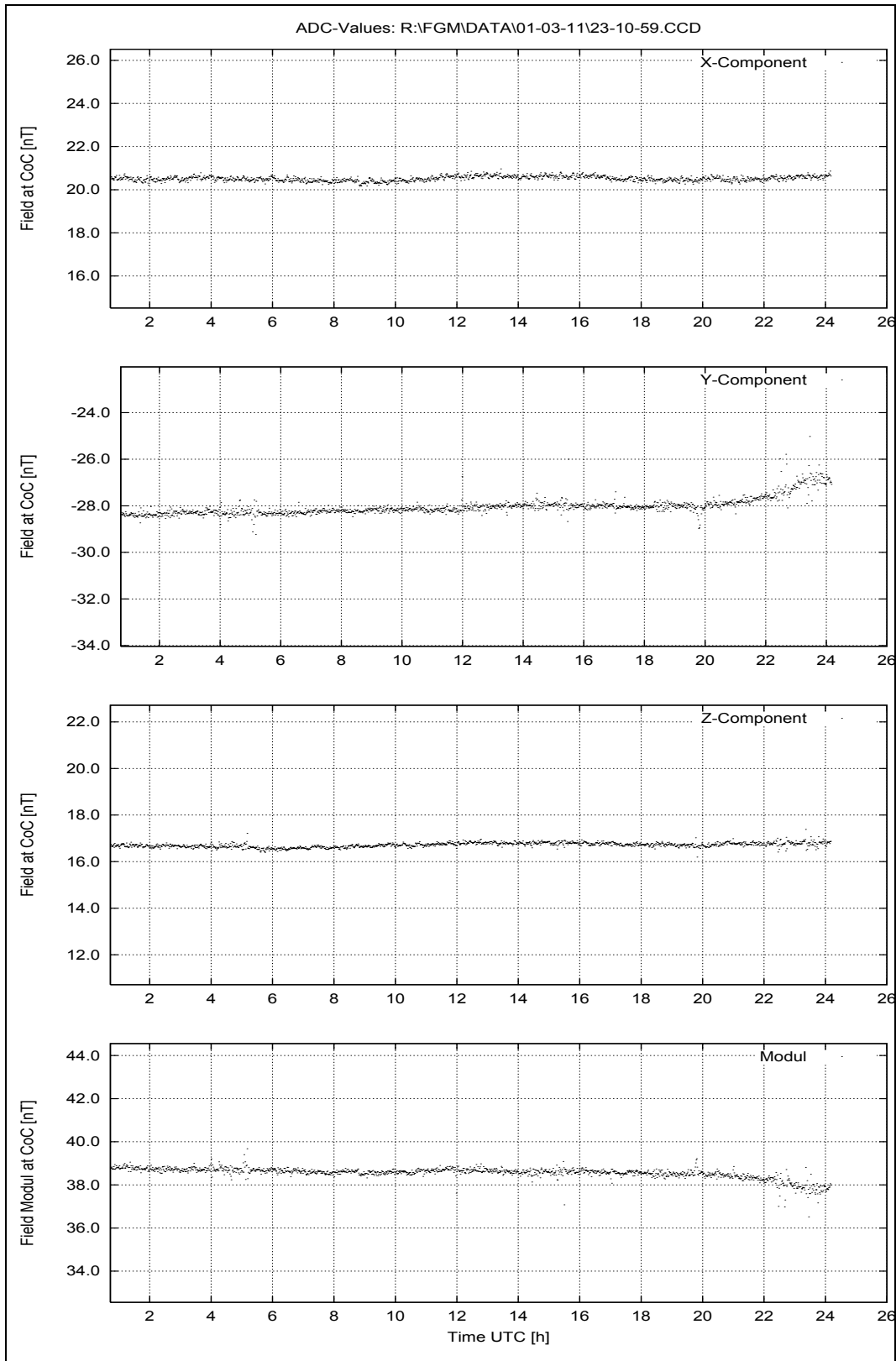

Figure 190: March 11, 2001: Zero field at CoC.

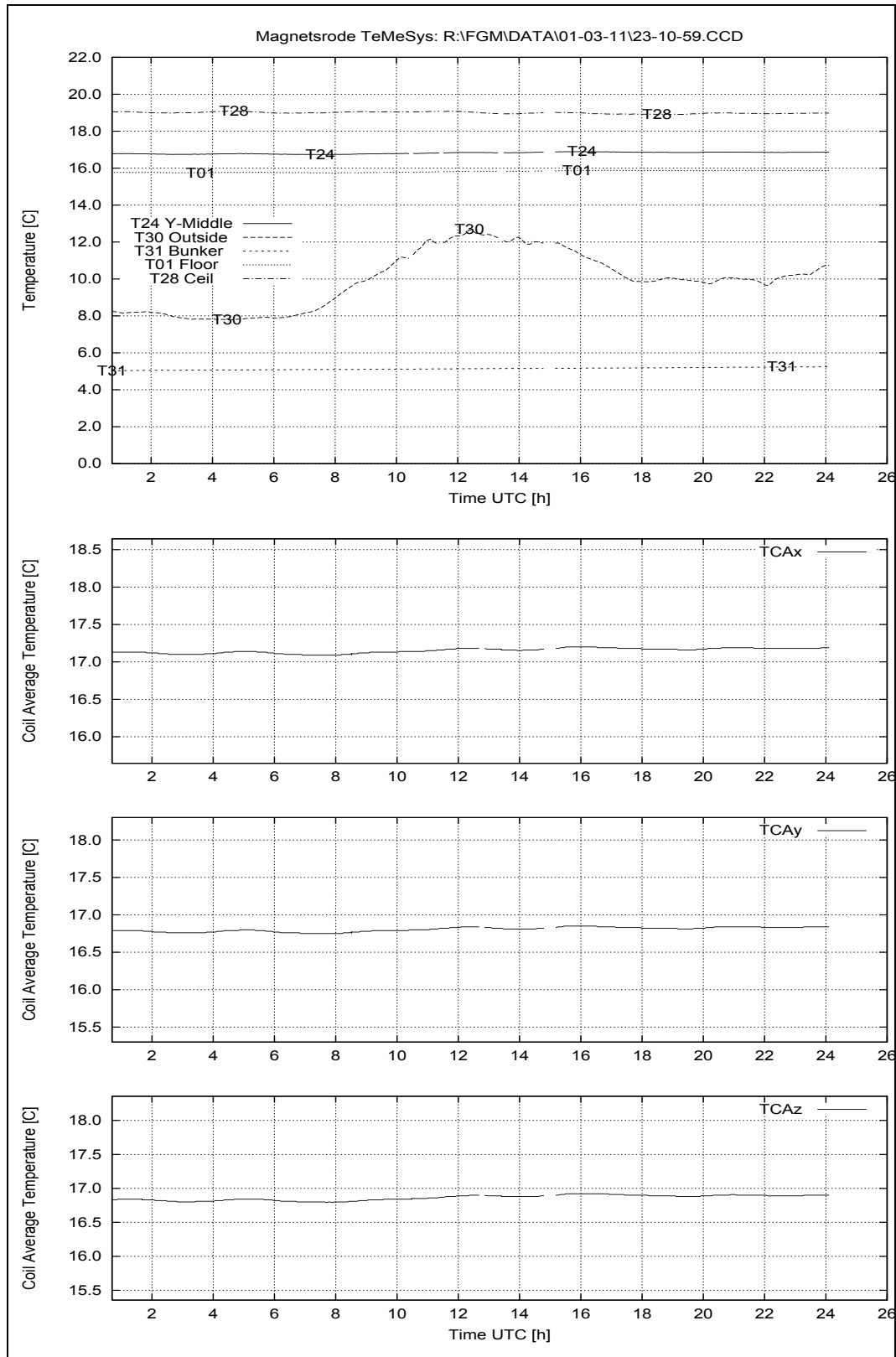

Figure 191: March 11, 2001: Temperatures House 2.

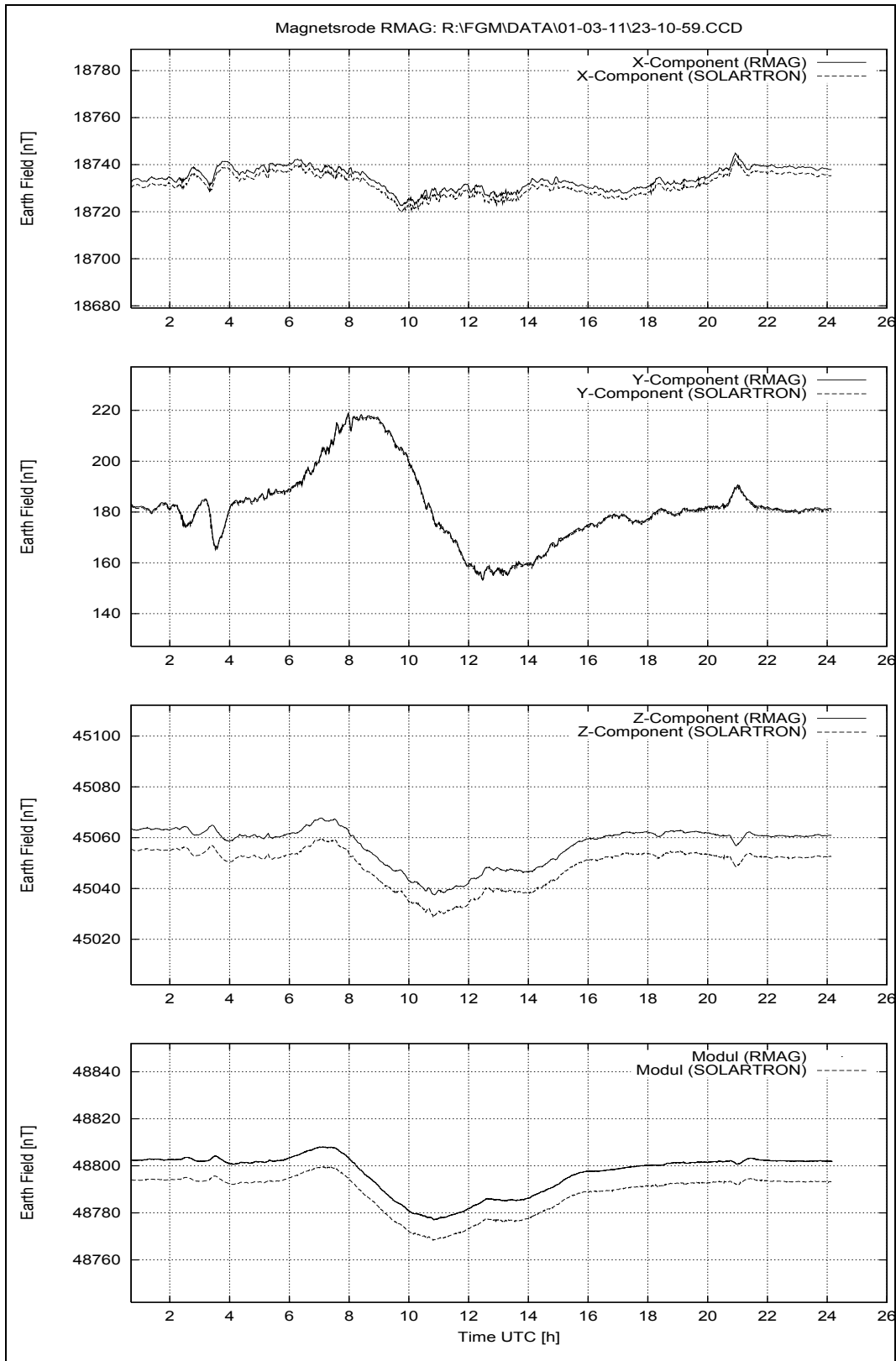

Figure 192: March 11, 2001: Earthfield variations.

B.6 Monday March 12, 2001

B.6.1 Overview Plots: System Performance, Temperatures and Earthfield Variations.

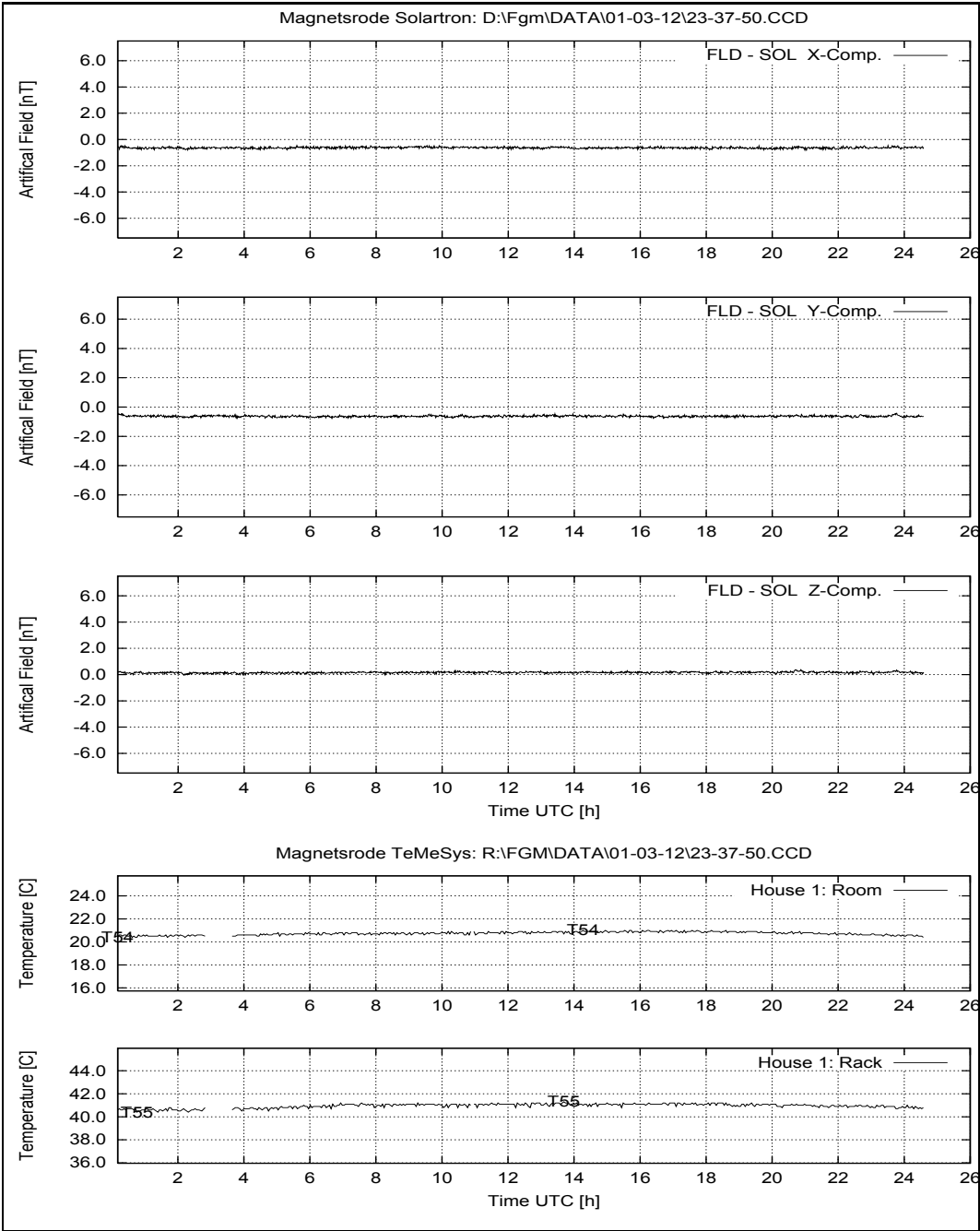

Figure 193: March 12, 2001: System Performance: FLD - SOL; Temperatures at House 1.

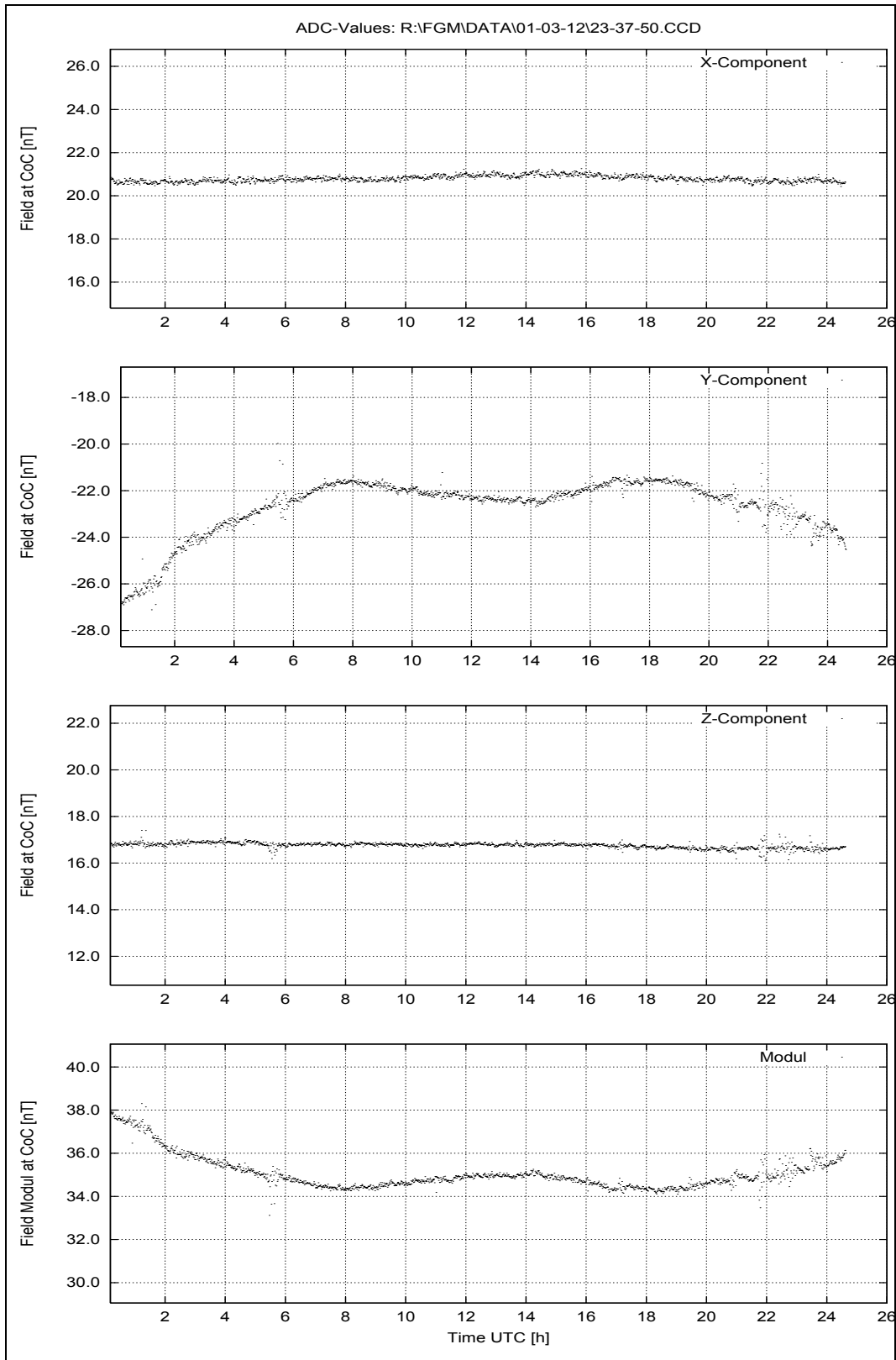

Figure 194: March 12, 2001: Zero field at CoC.

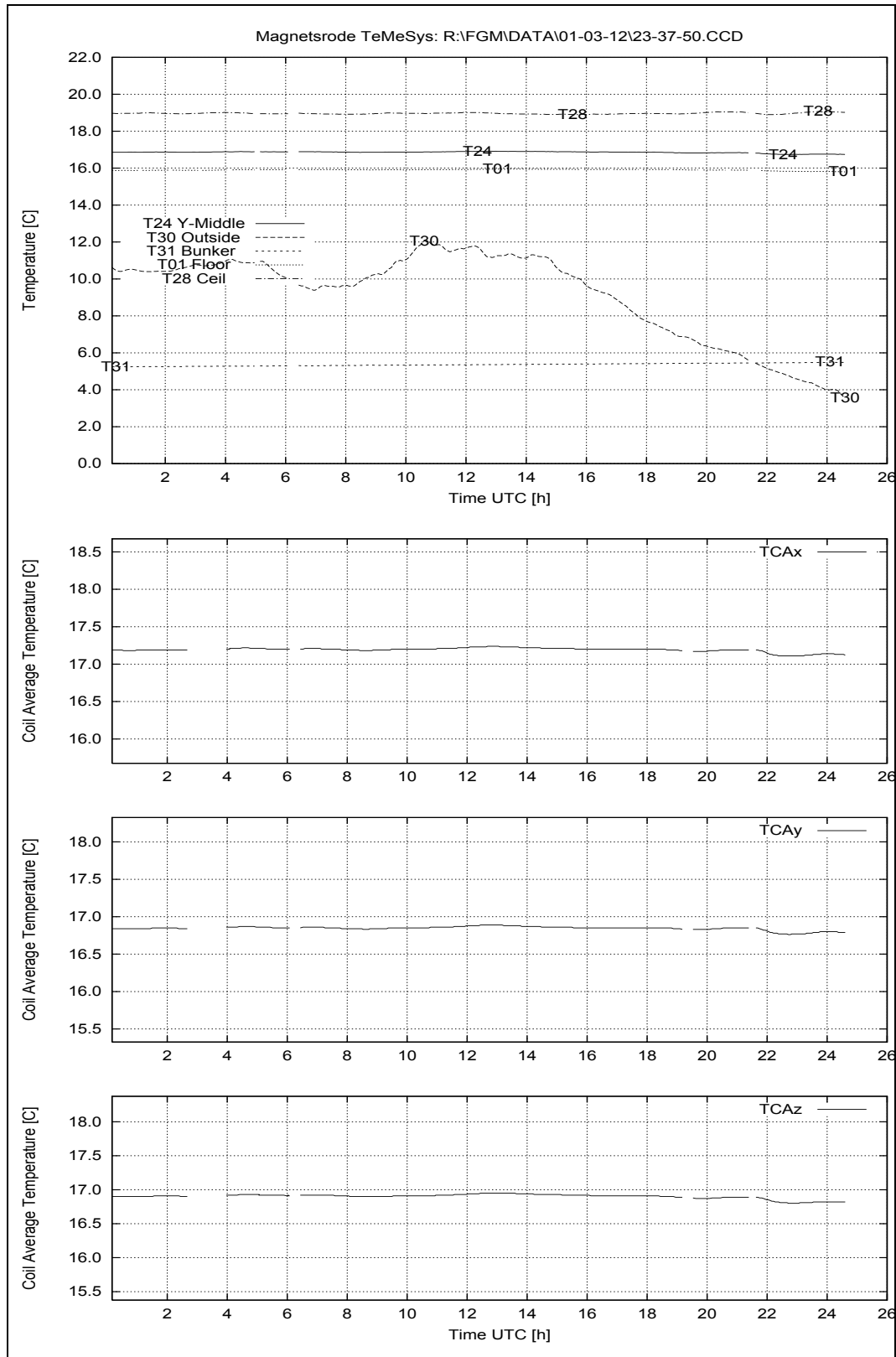

Figure 195: March 12, 2001: Temperatures House 2.

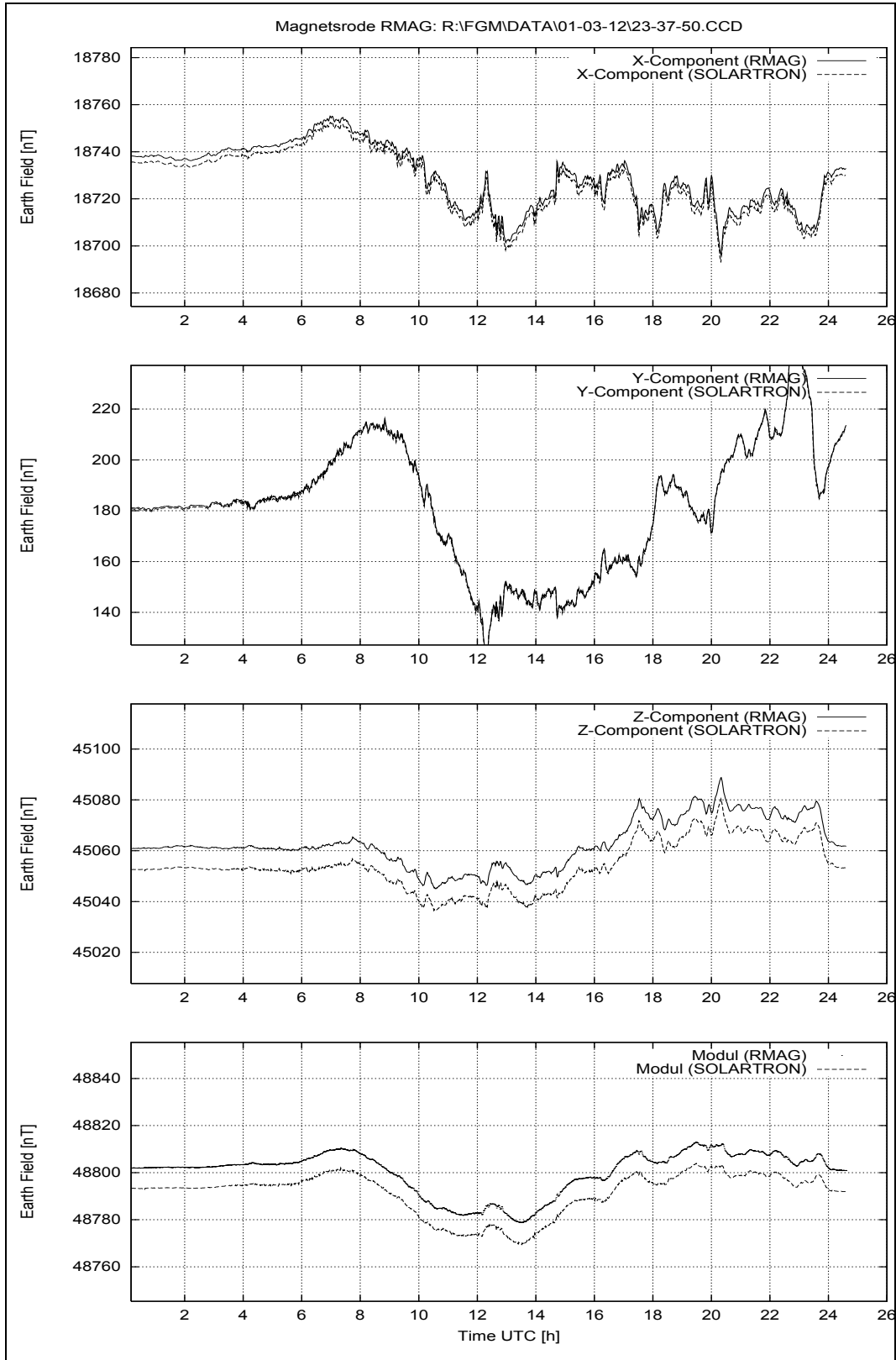

Figure 196: March 12, 2001: Earthfield variations.

B.7 Tuesday March 13, 2001

B.7.1 Overview Plots: System Performance, Temperatures and Earthfield Variations.

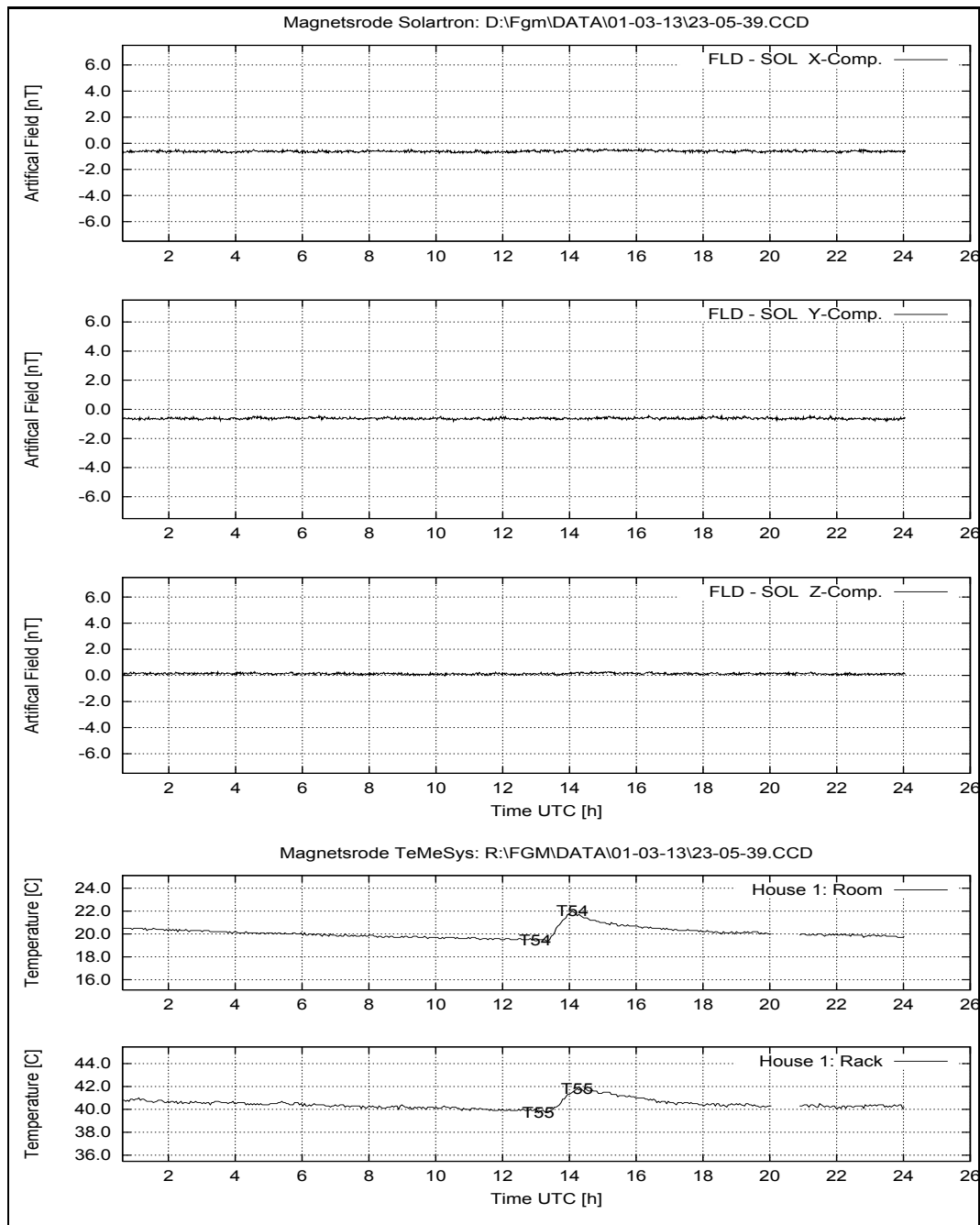

Figure 197: March 13, 2001: System Performance: FLD – SOL; Temperatures at House 1.

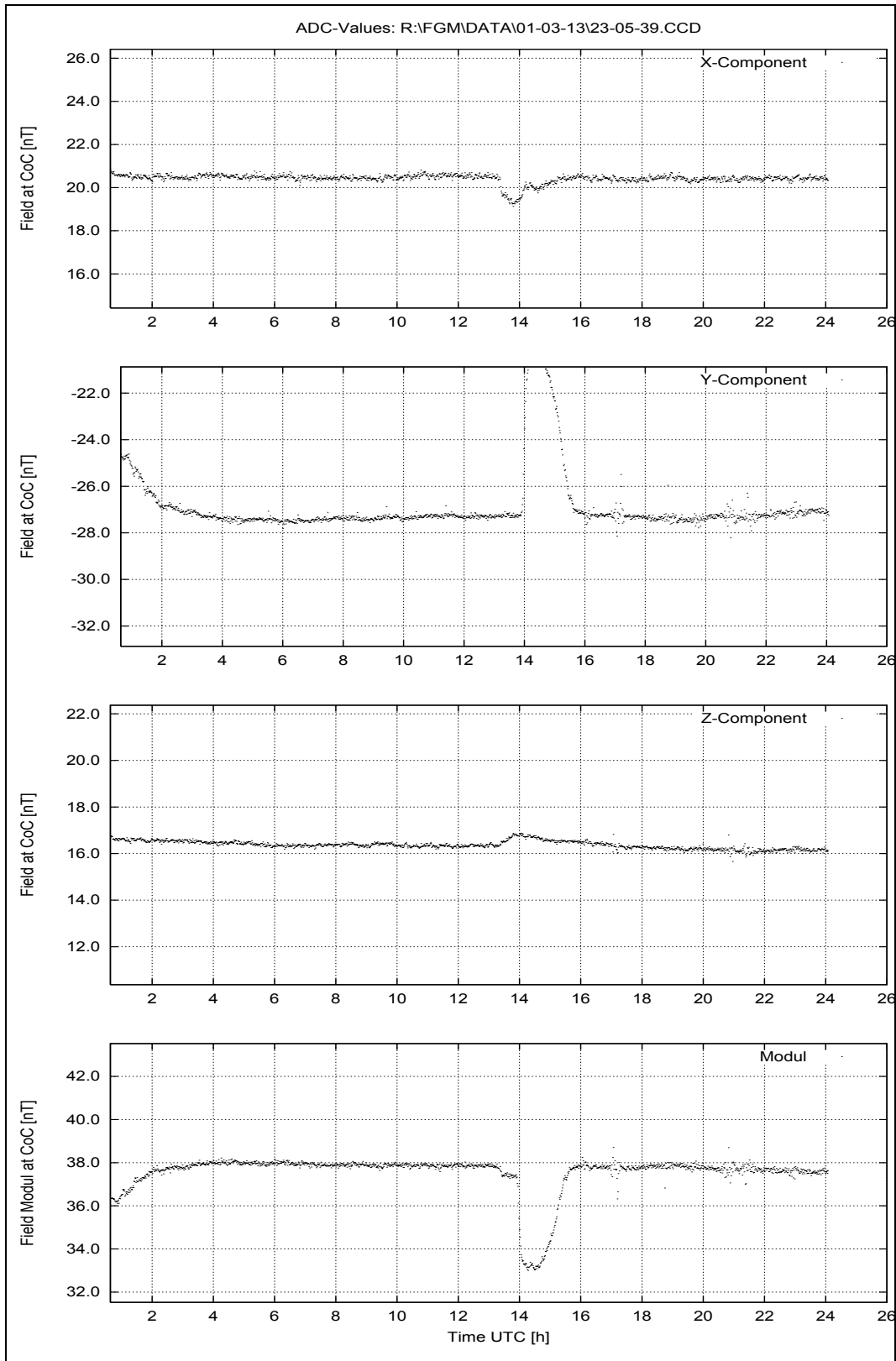

Figure 198: March 13, 2001: Zero field at CoC.

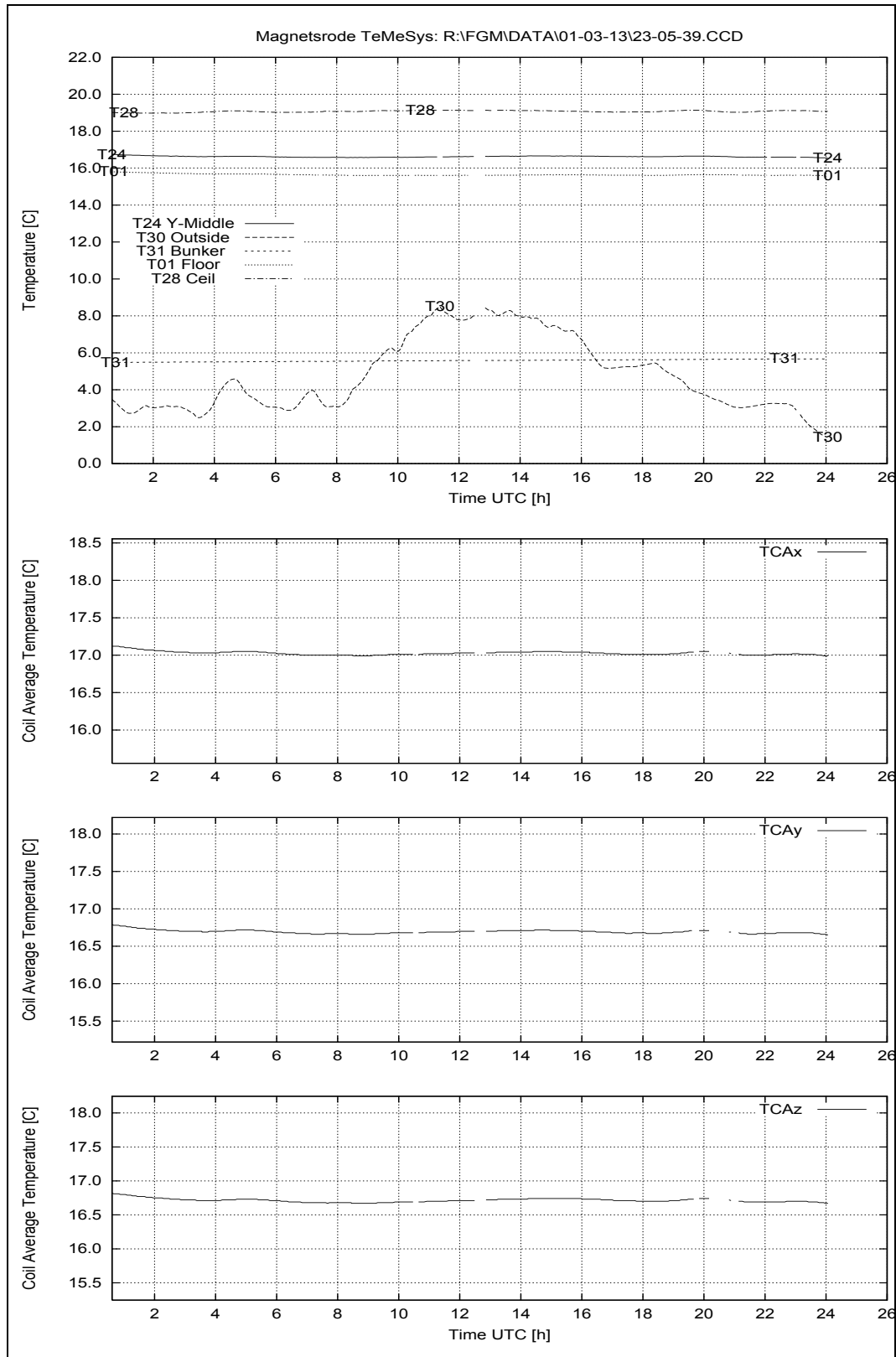

Figure 199: March 13, 2001: Temperatures House 2.

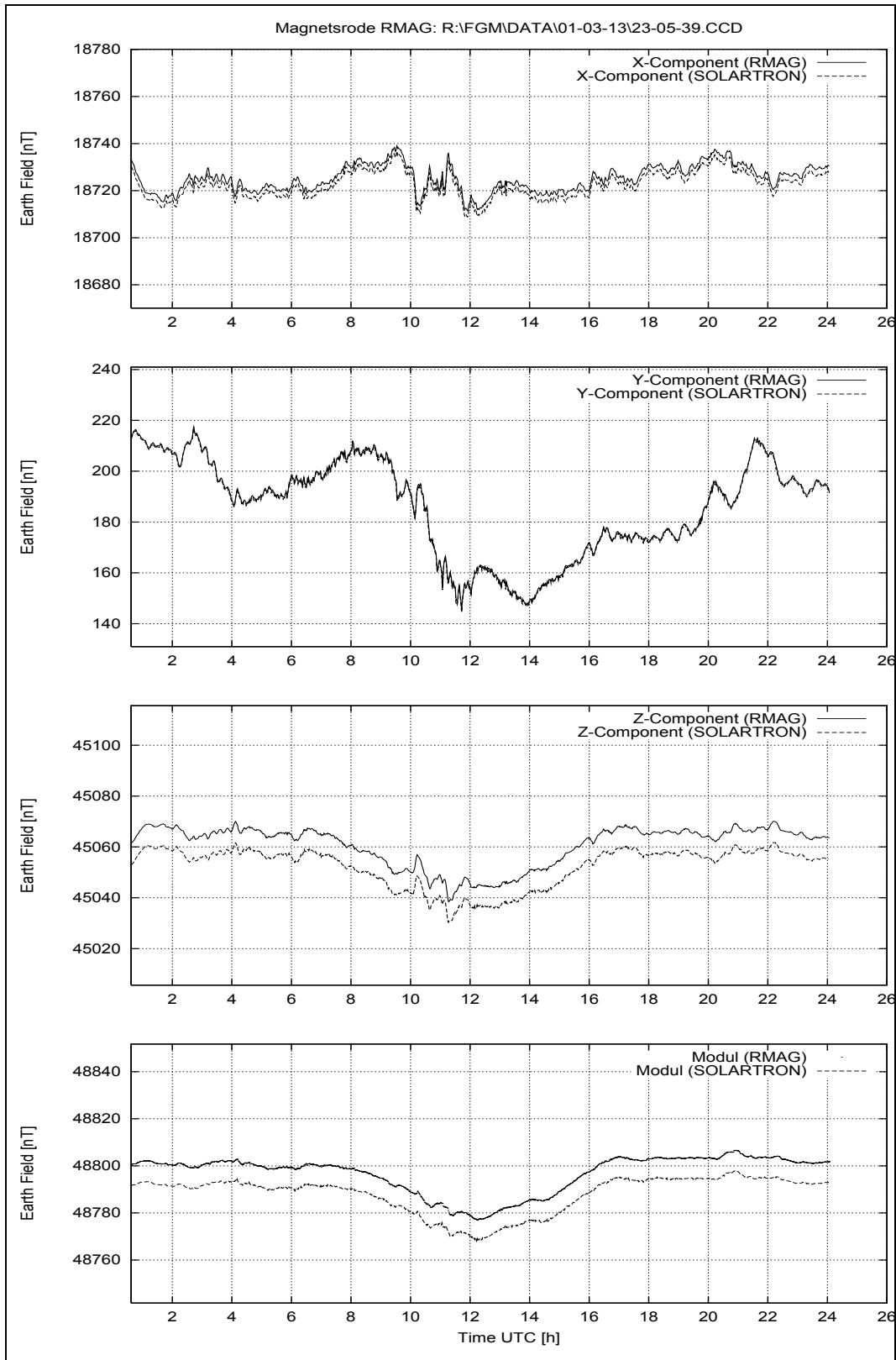

Figure 200: March 13, 2001: Earthfield variations.

B.8 Wednesday March 14, 2001

B.8.1 Overview Plots: System Performance, Temperatures and Earthfield Variations.

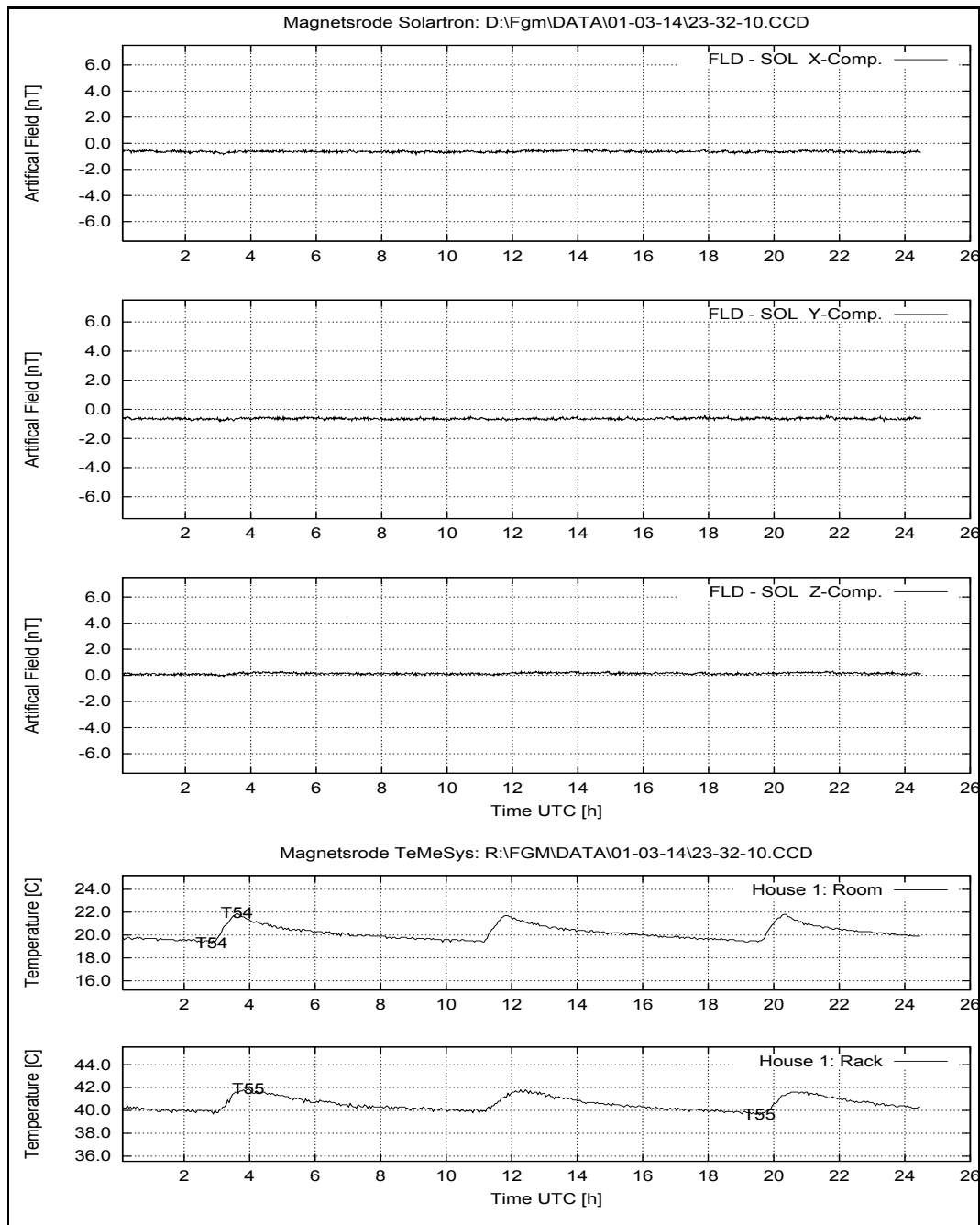

Figure 201: March 14, 2001: System Performance: FLD – SOL; Temperatures at House 1.

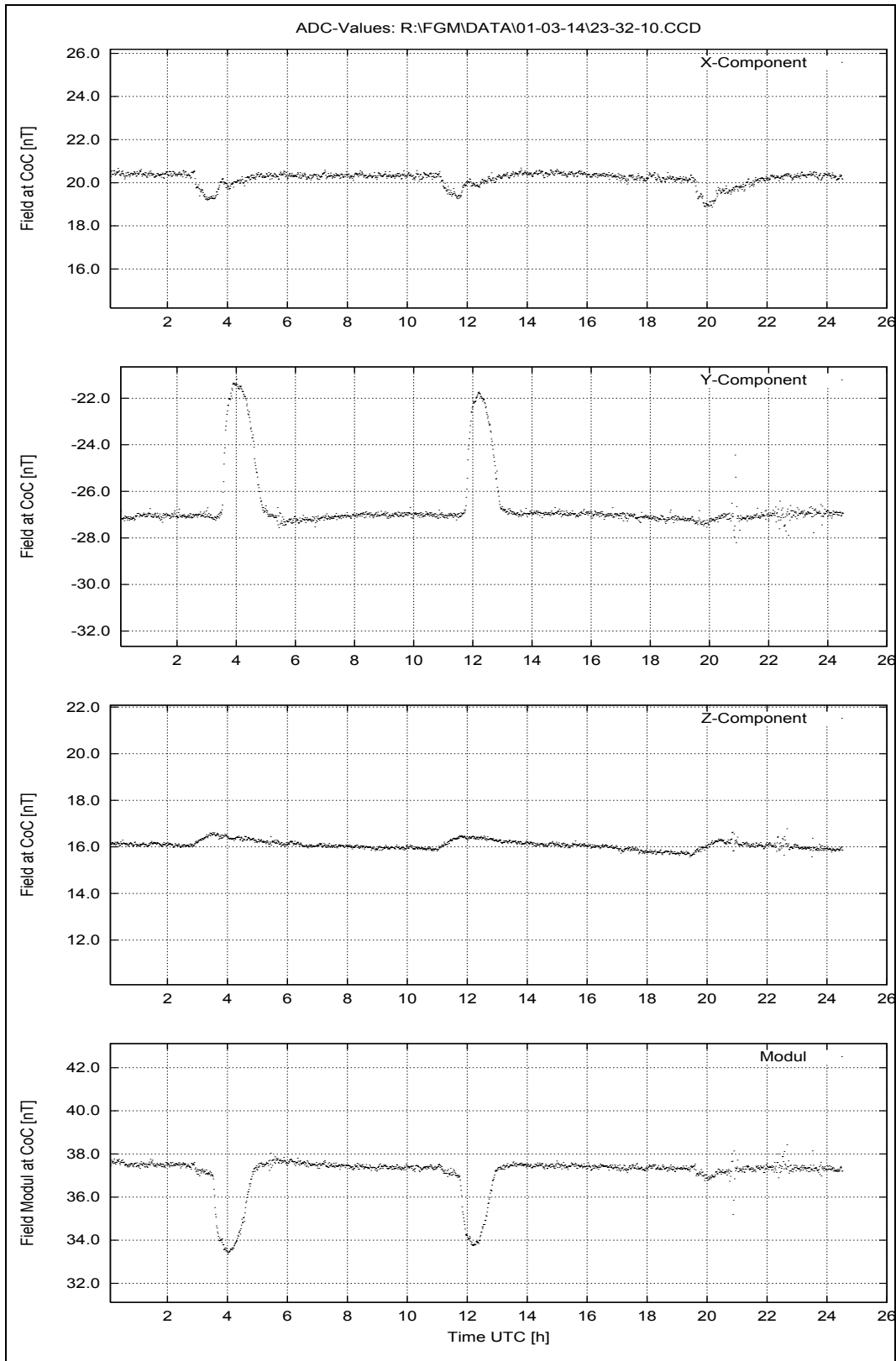

Figure 202: March 14, 2001: Zero field at CoC.

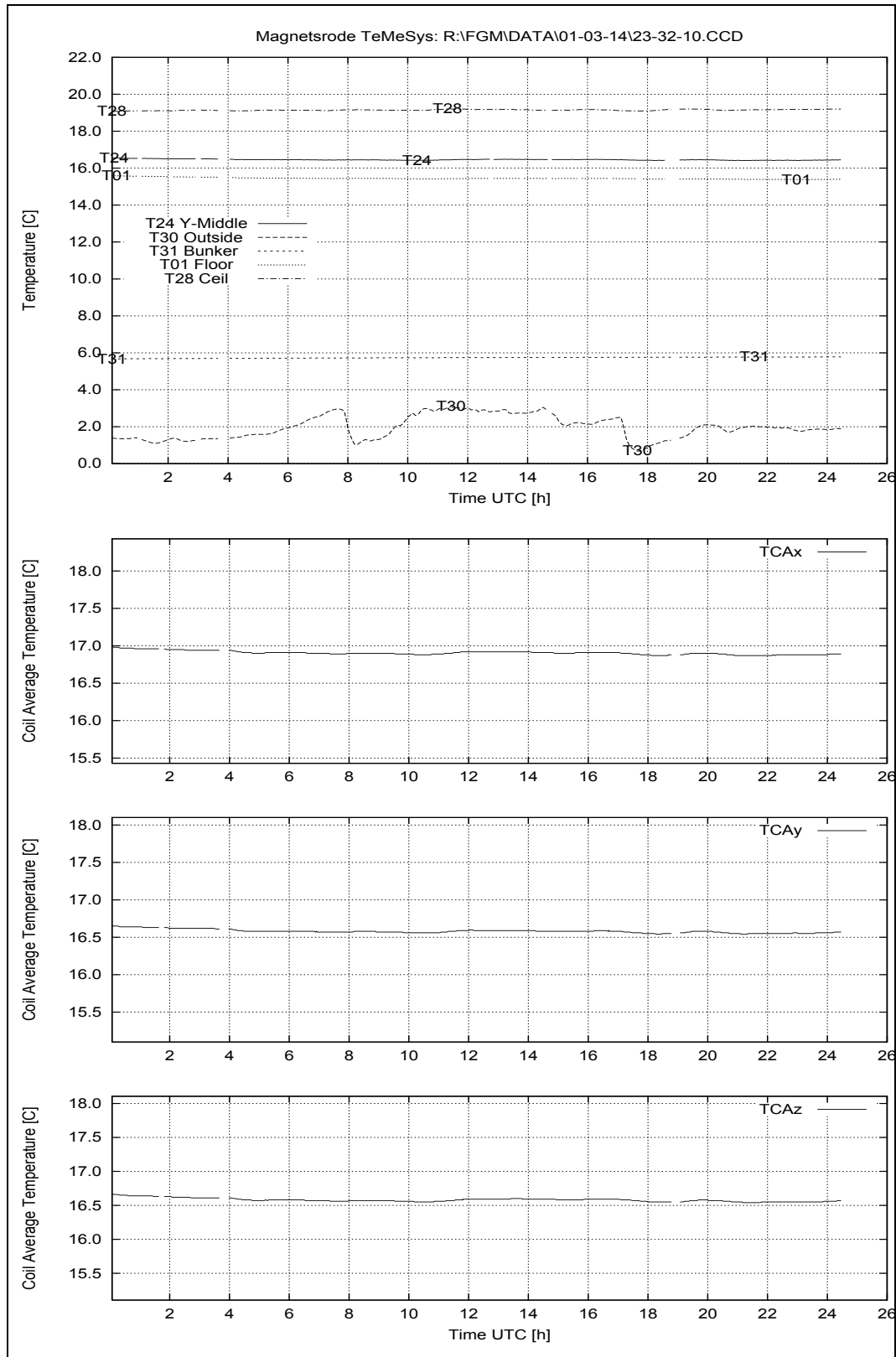

Figure 203: March 14, 2001: Temperatures House 2.

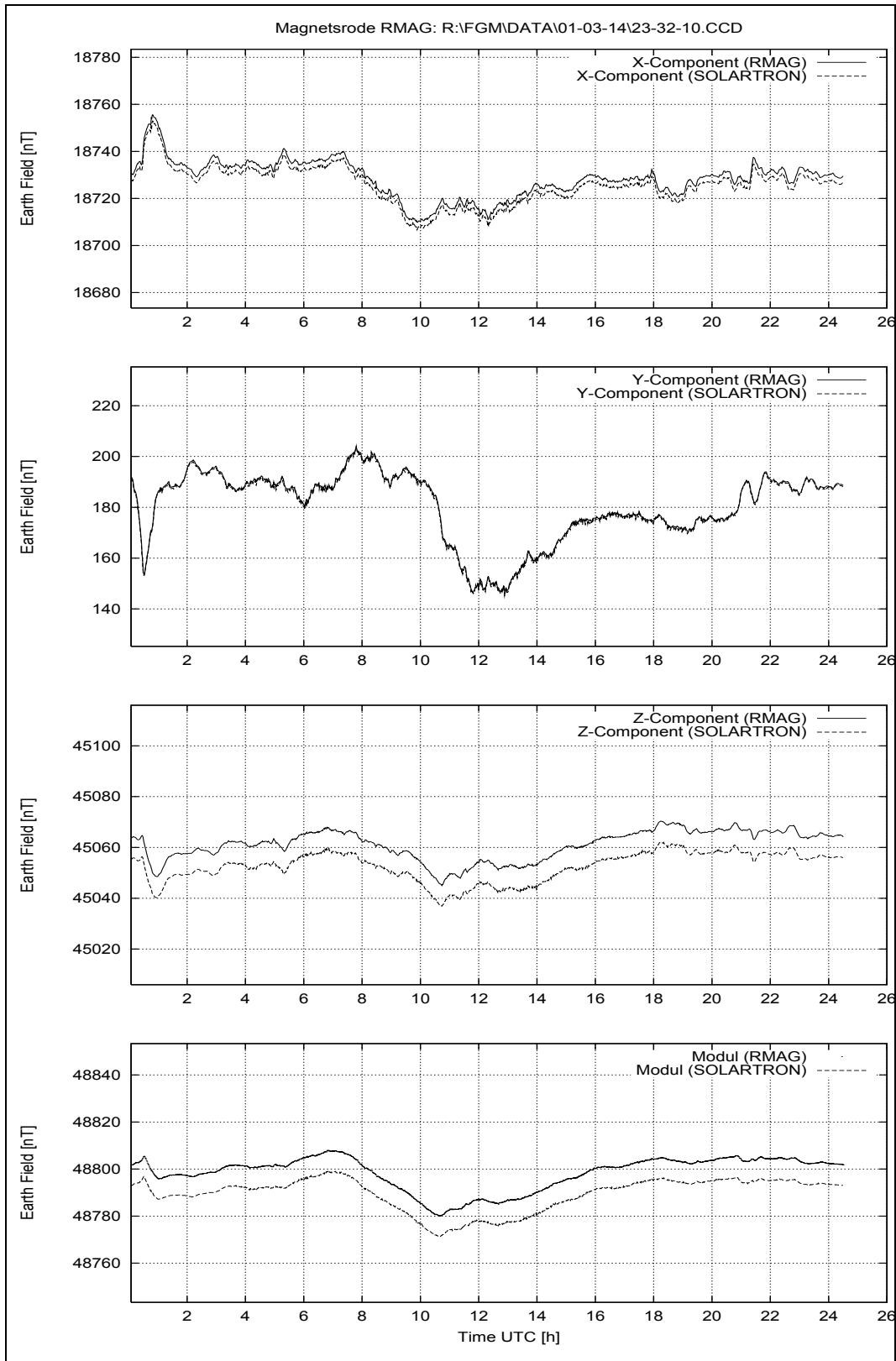

Figure 204: March 14, 2001: Earthfield variations.

B.9 Thursday March 15, 2001

B.9.1 Overview Plots: System Performance, Temperatures and Earthfield Variations.

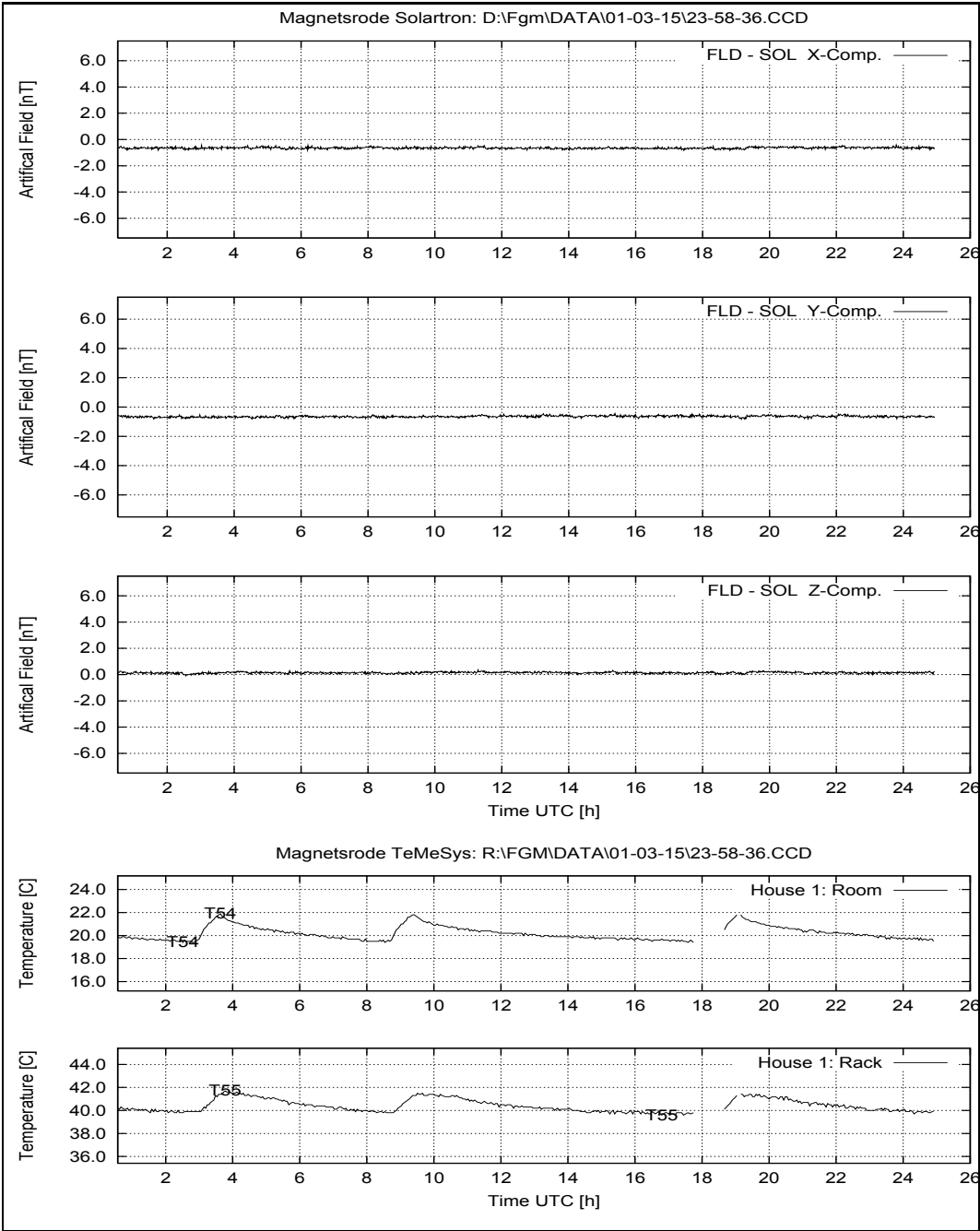

Figure 205: March 15, 2001: System Performance: FLD – SOL; Temperatures at House 1.

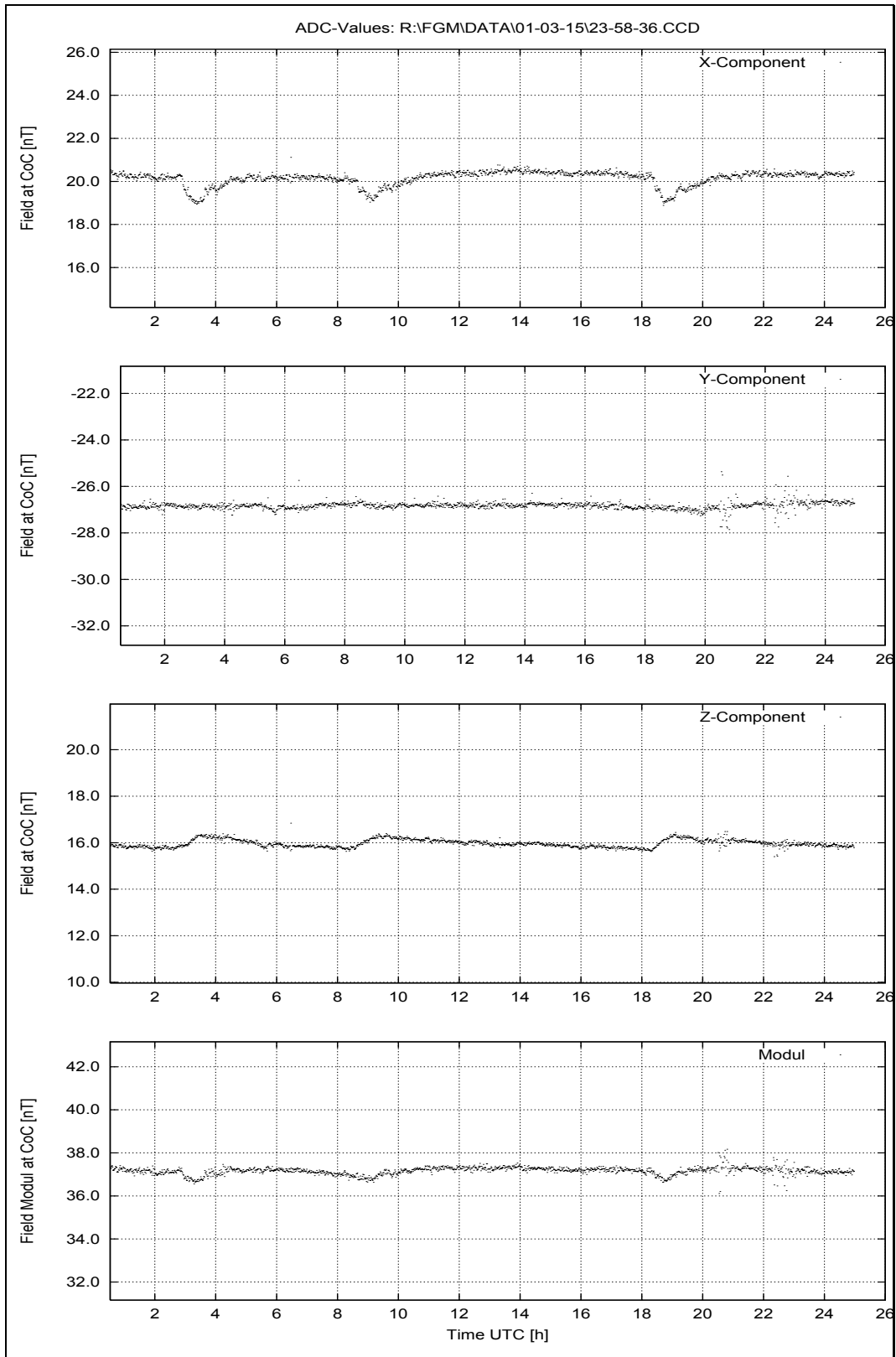

Figure 206: March 15, 2001: Zero field at CoC.

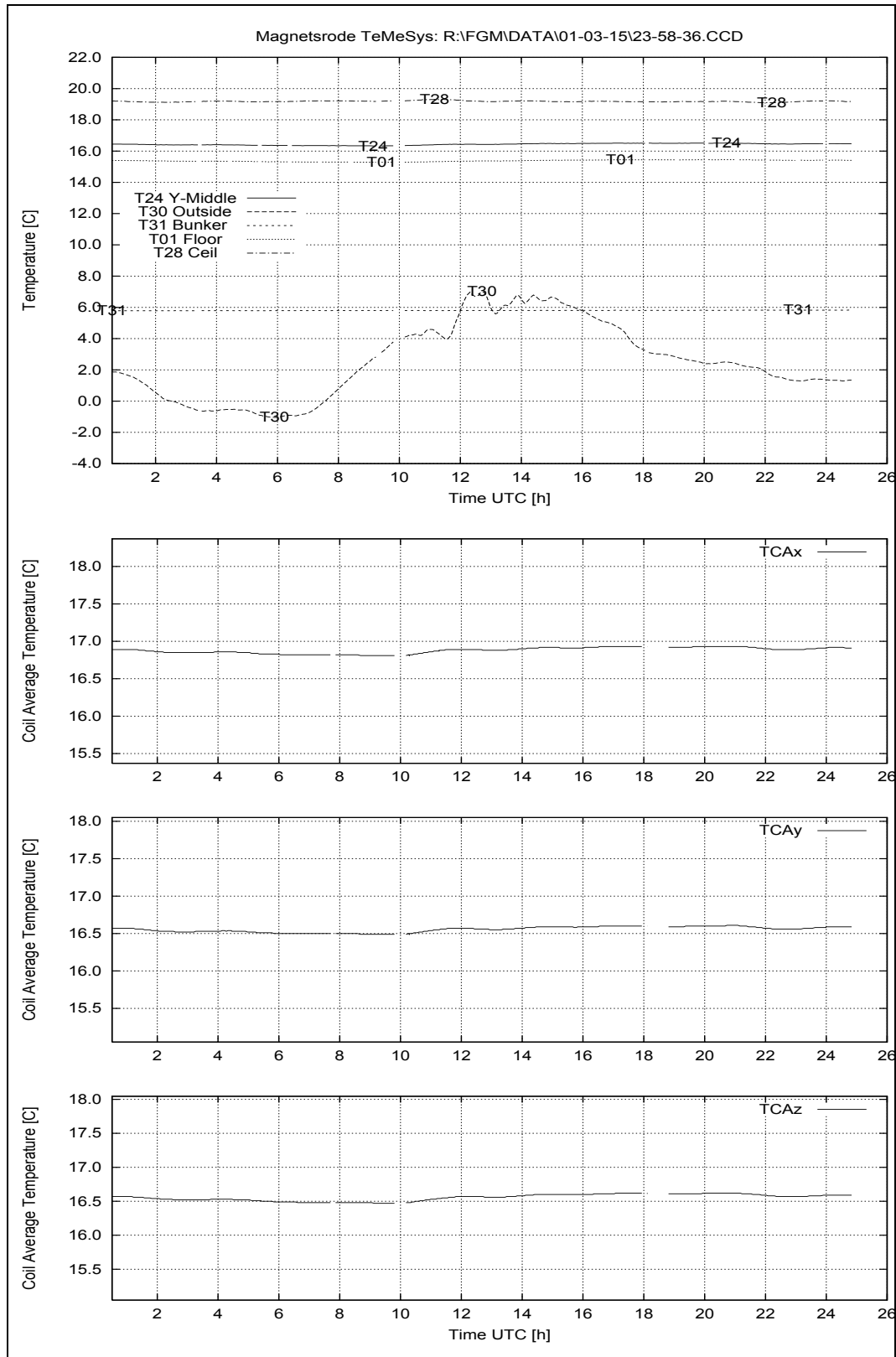

Figure 207: March 15, 2001: Temperatures House 2.

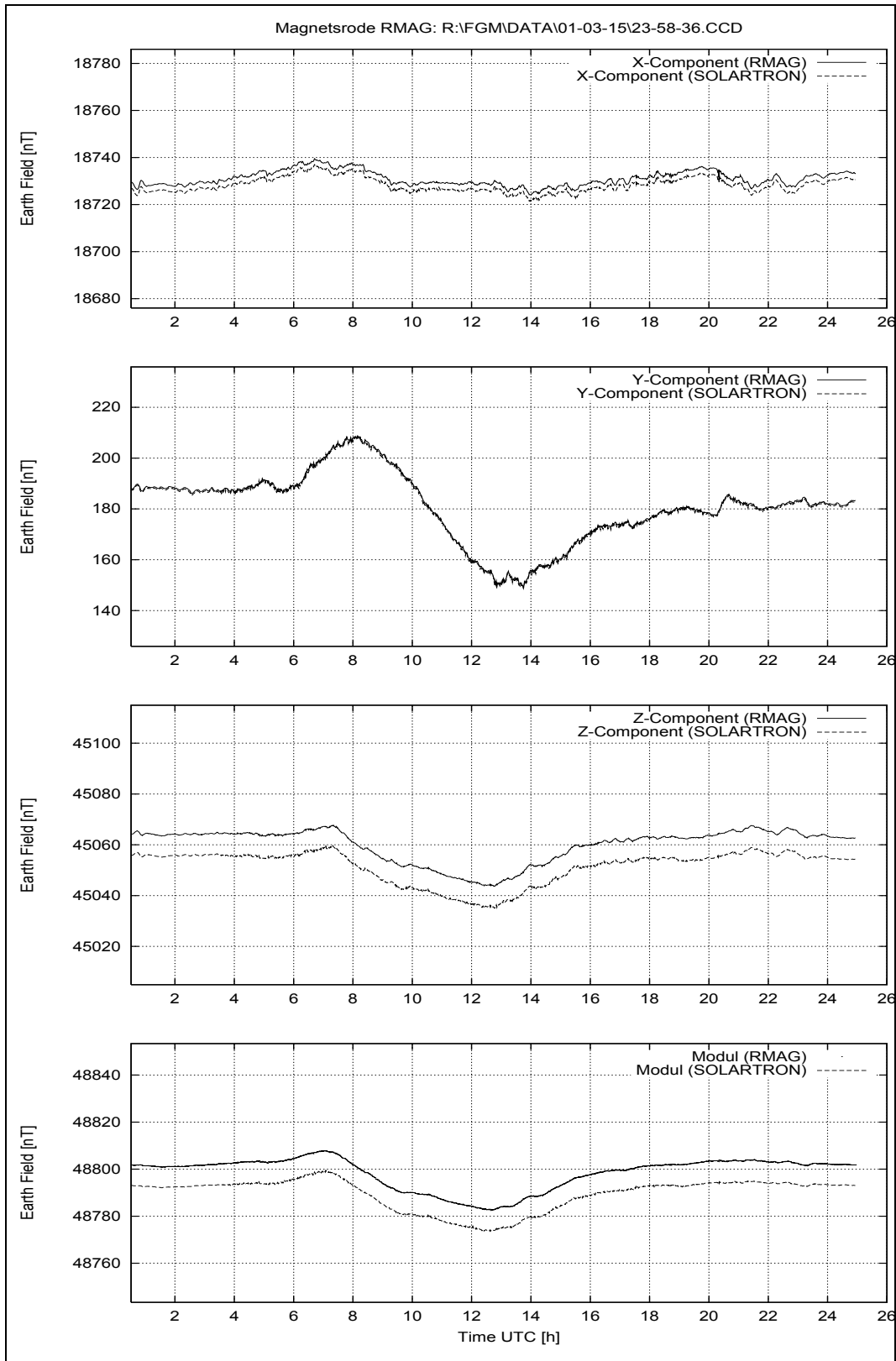

Figure 208: March 15, 2001: Earthfield variations.

B.10 Friday March 16, 2001

B.10.1 Overview Plots: System Performance, Temperatures and Earthfield Variations.

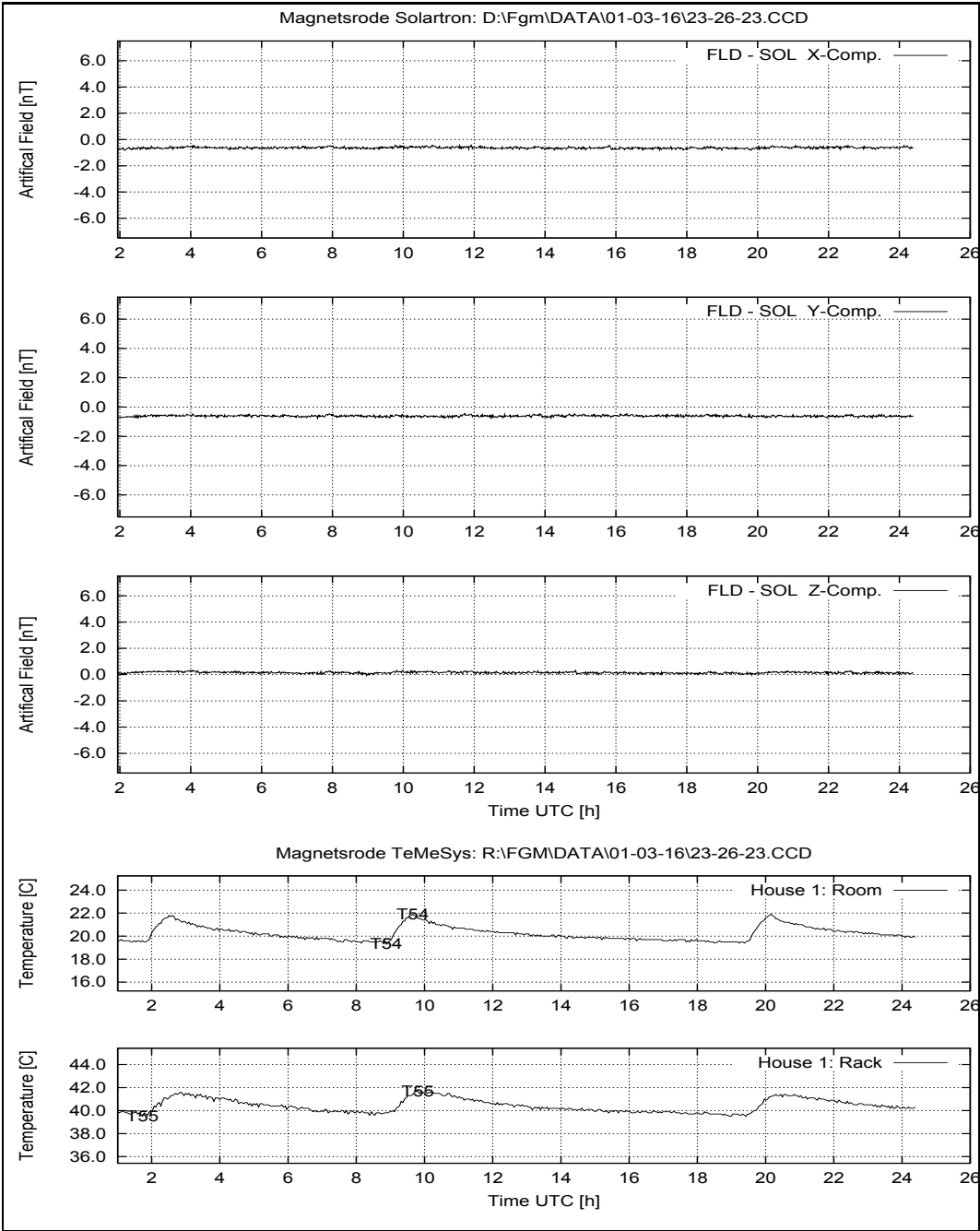

Figure 209: March 16, 2001: System Performance: FLD – SOL; Temperatures at House 1.

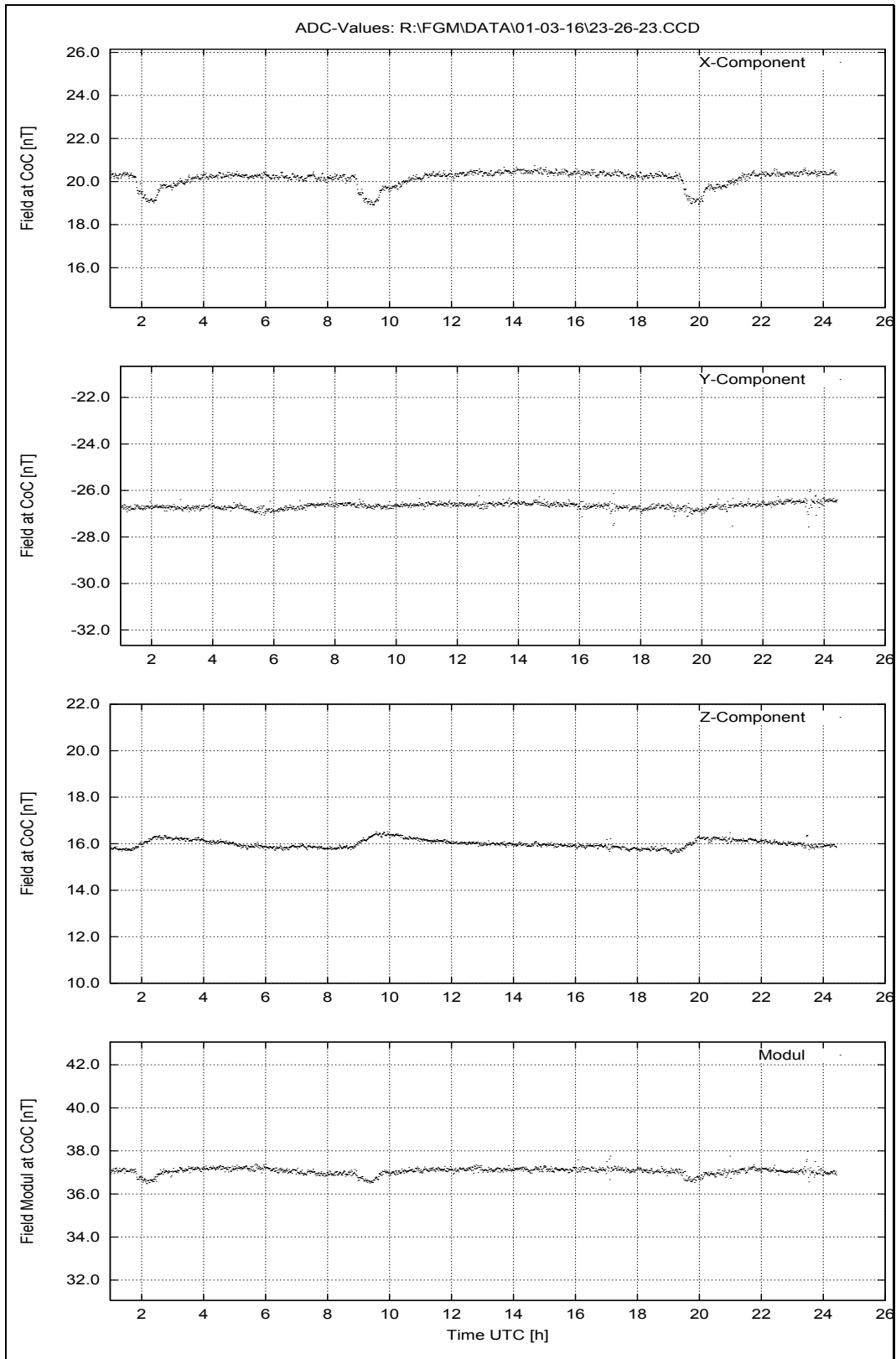

Figure 210: March 16, 2001: Zero field at CoC.

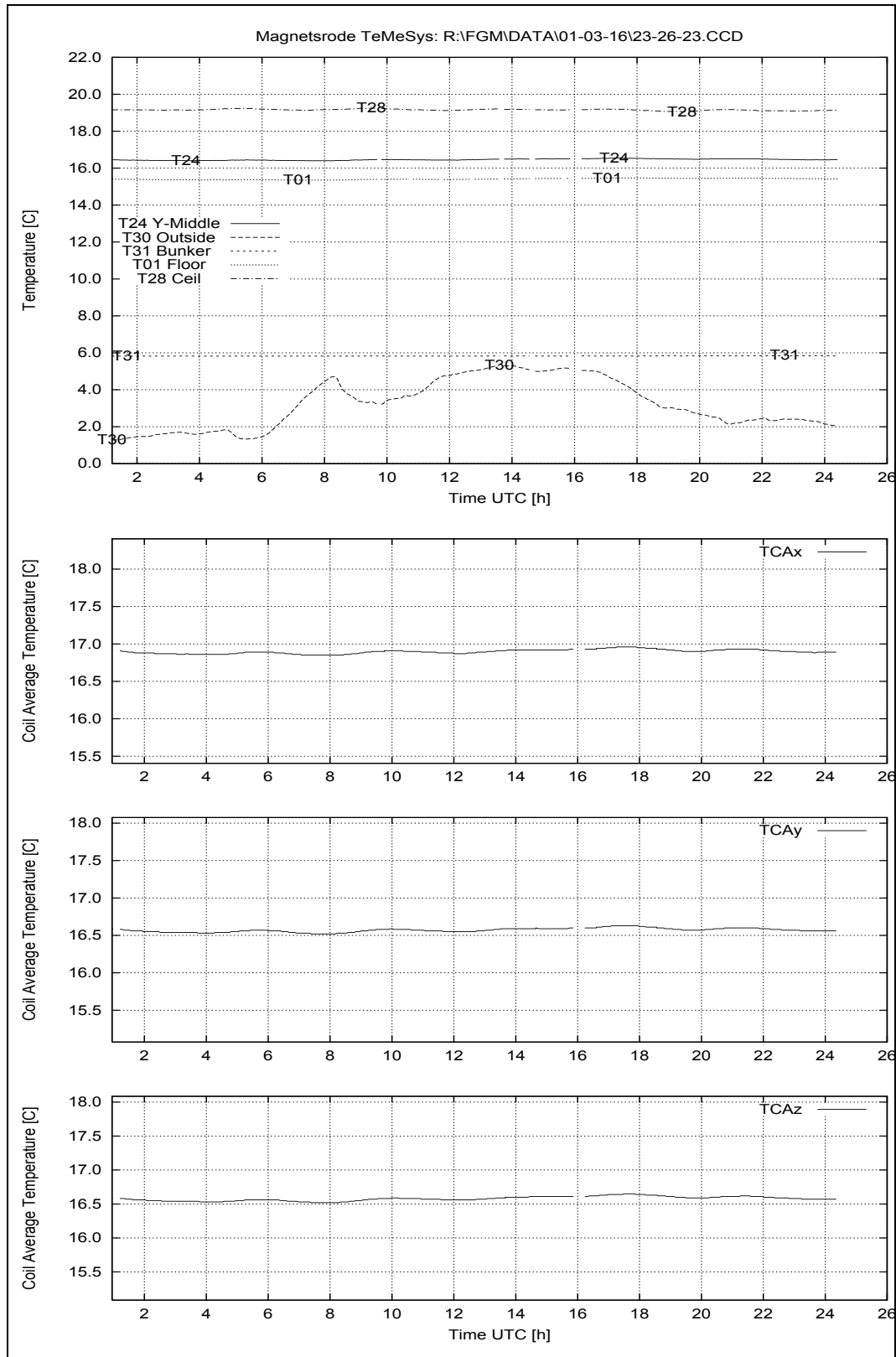

Figure 211: March 16, 2001: Temperatures House 2.

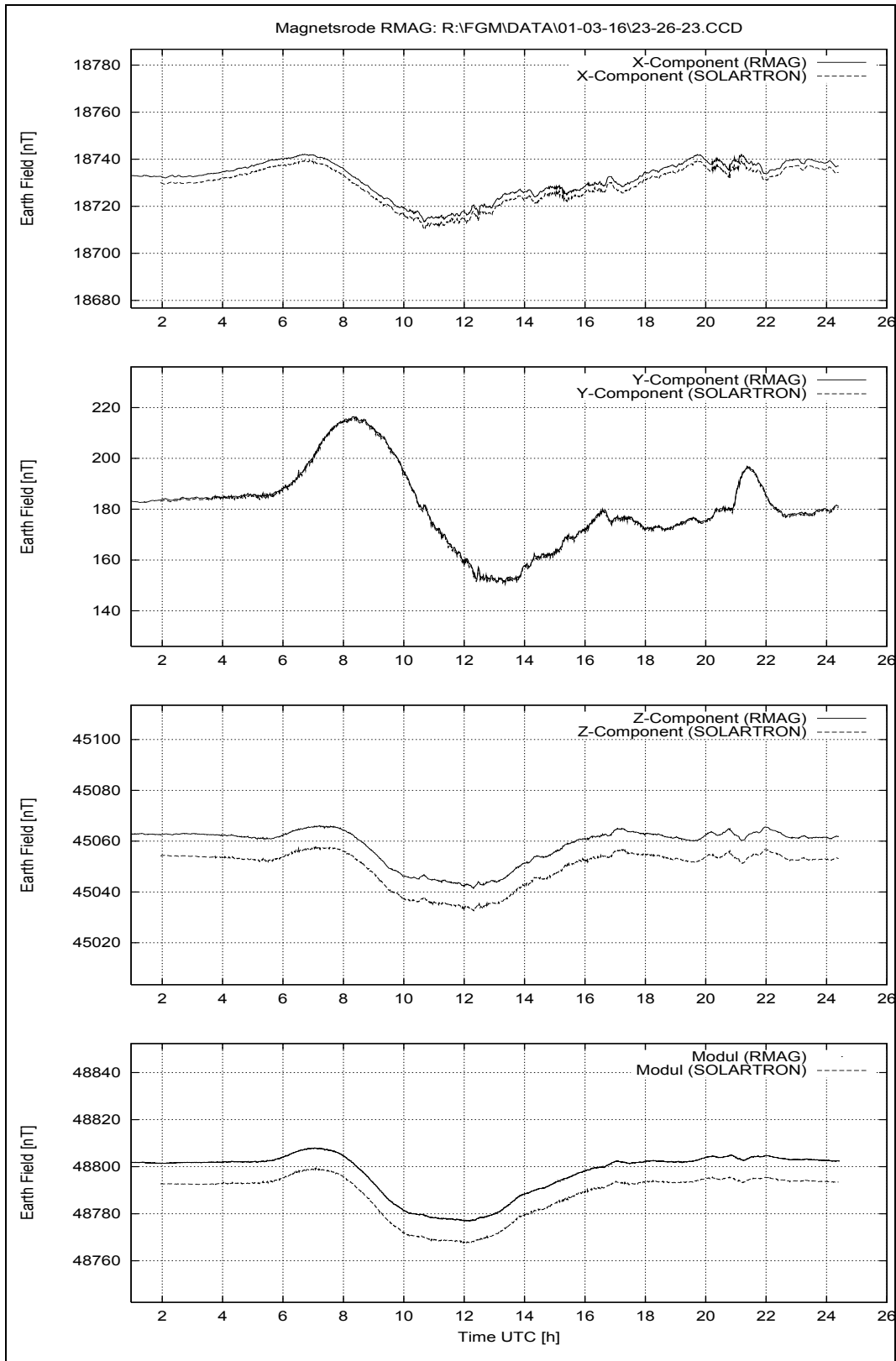

Figure 212: March 16, 2001: Earthfield variations.

B.11 Saturday March 17, 2001

B.11.1 Overview Plots: System Performance, Temperatures and Earthfield Variations.

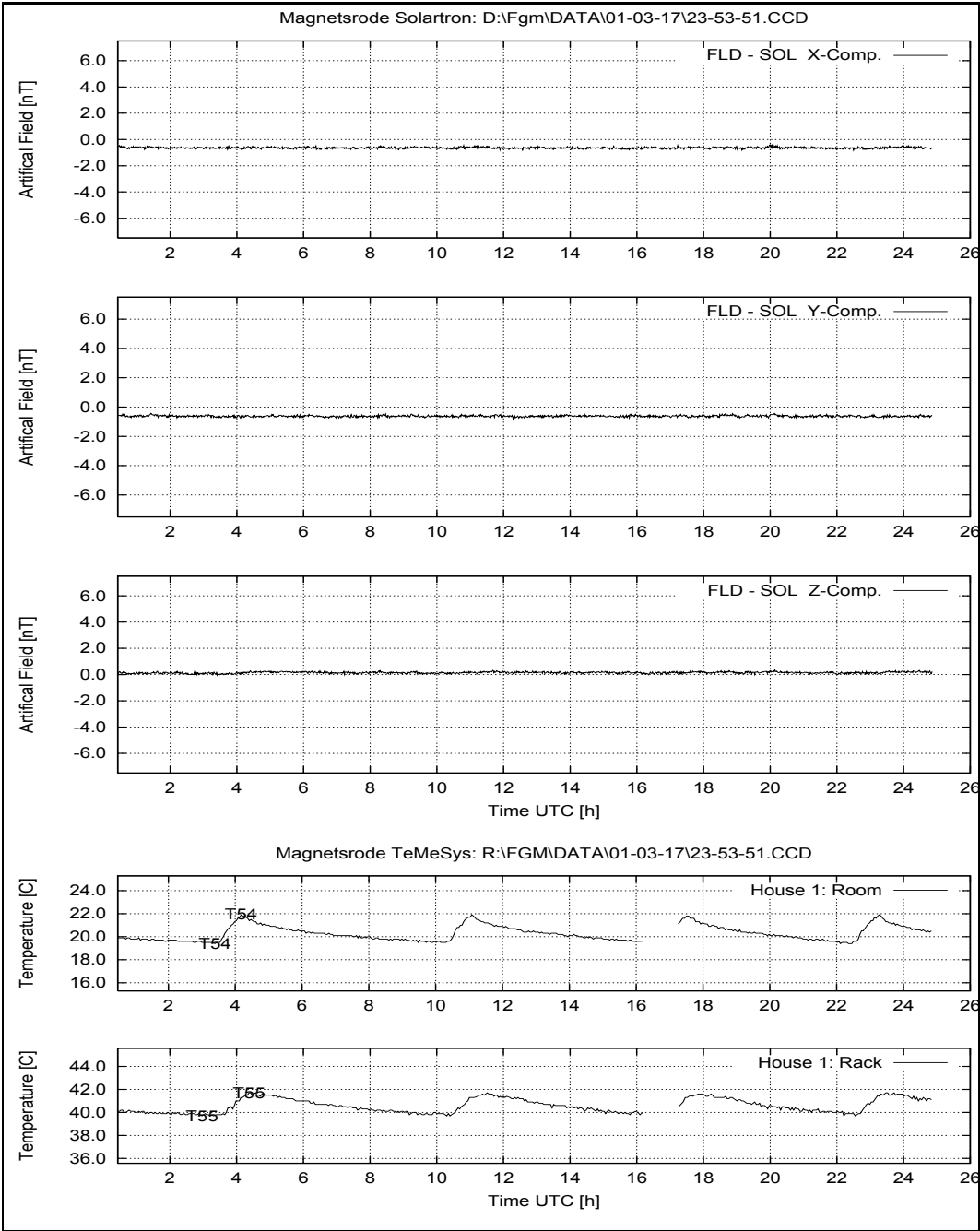

Figure 213: March 17, 2001: System Performance: FLD – SOL; Temperatures at House 1.

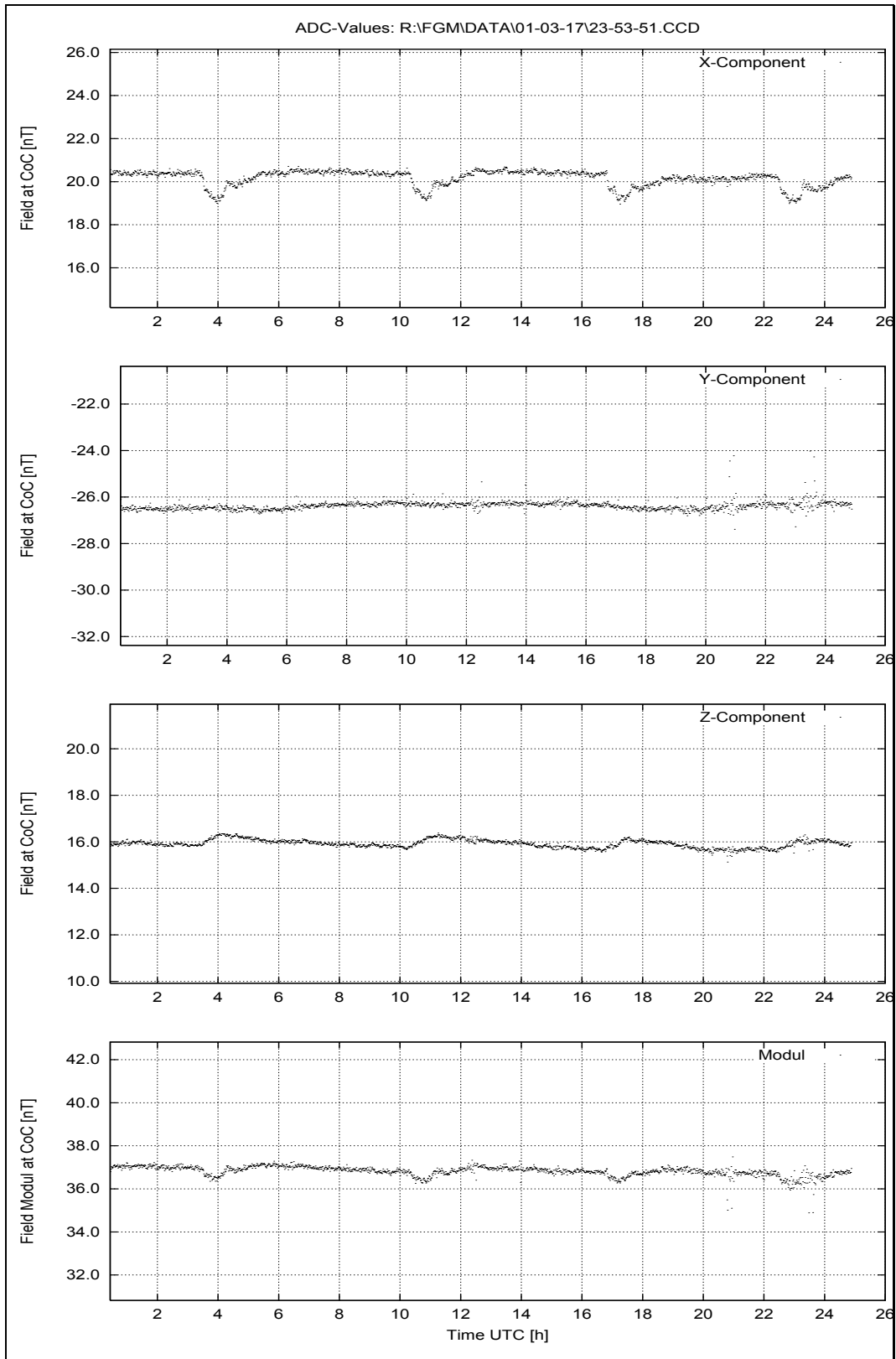

Figure 214: March 17, 2001: Zero field at CoC.

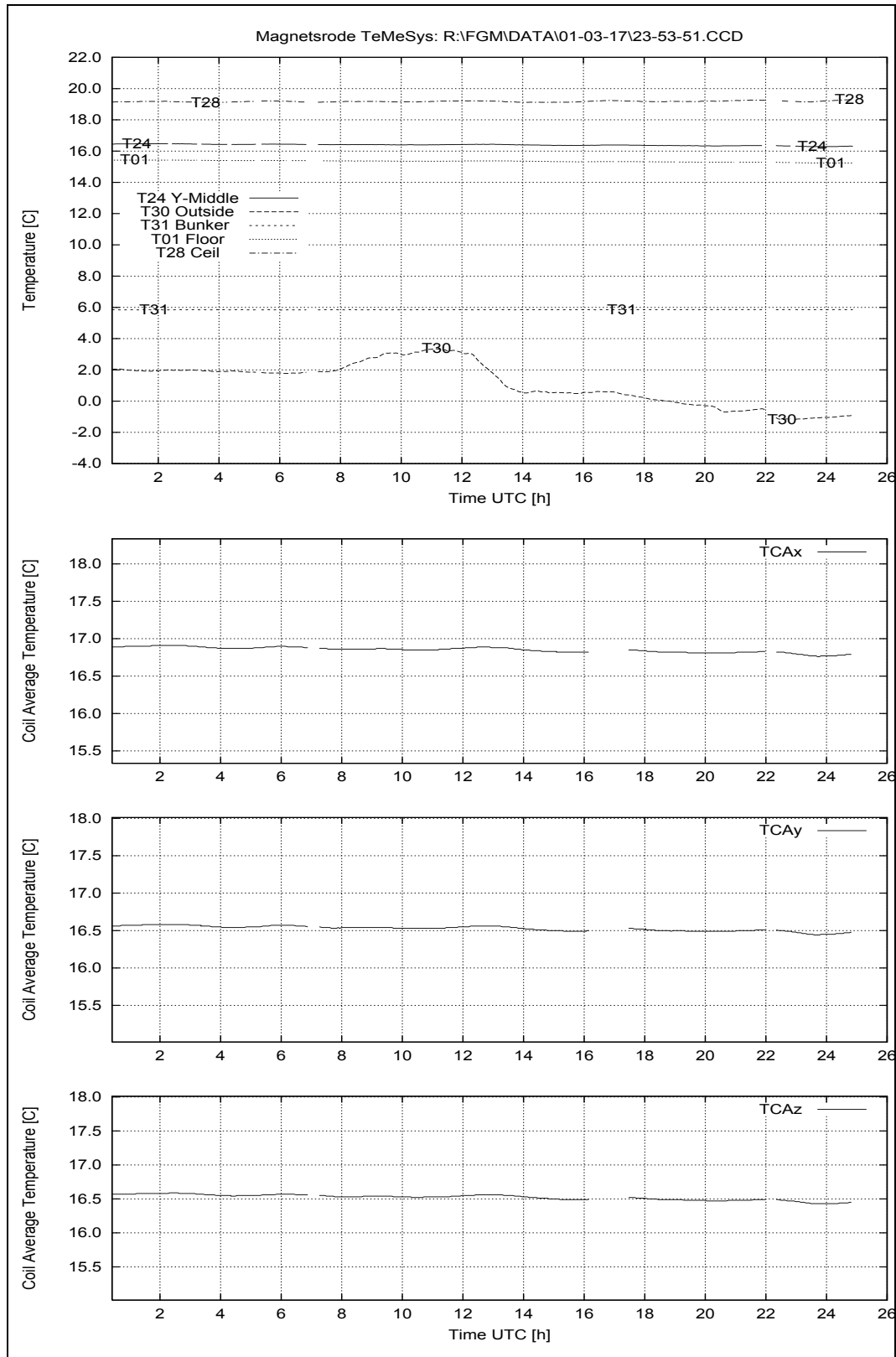

Figure 215: March 17, 2001: Temperatures House 2.

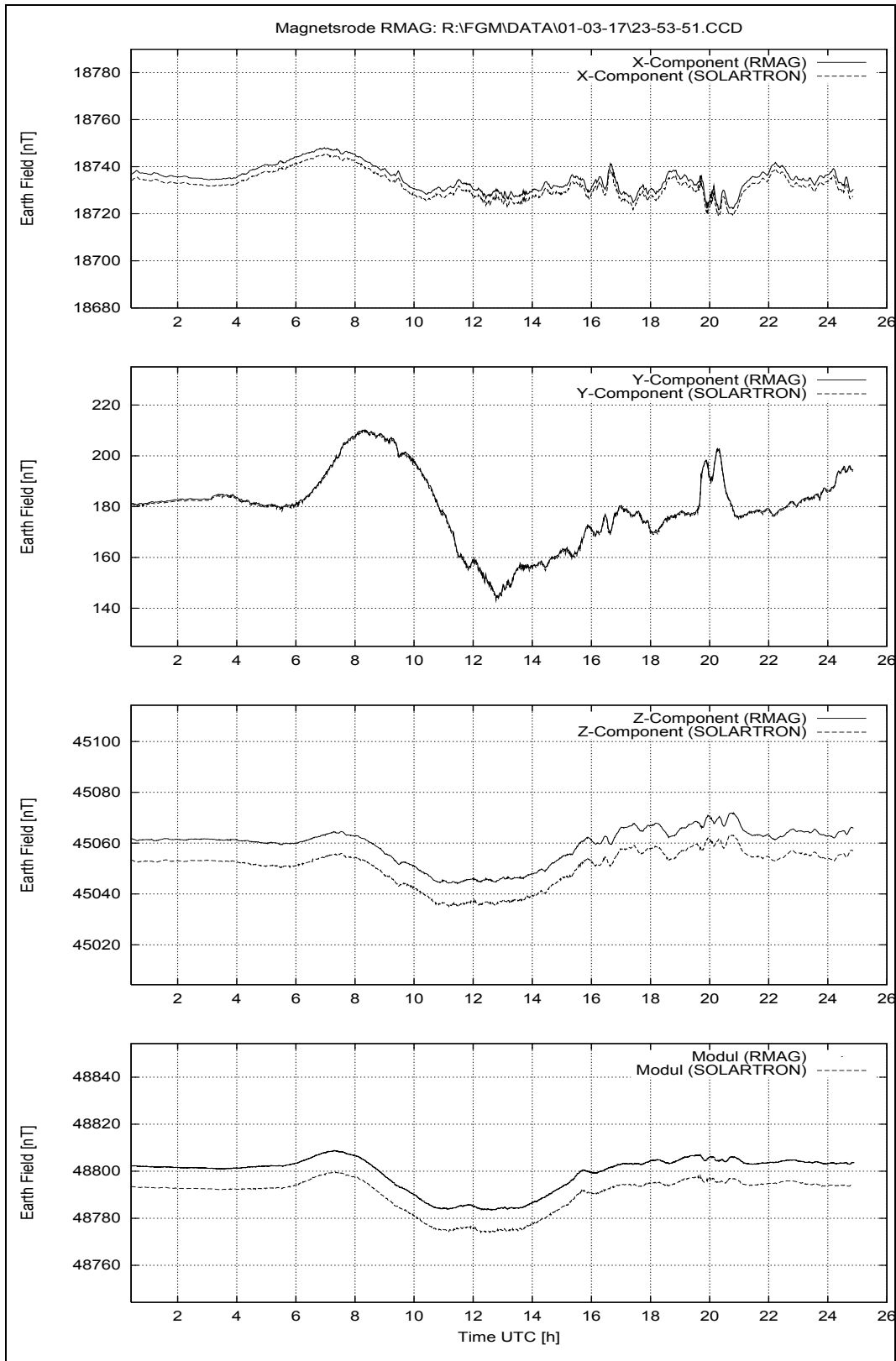

Figure 216: March 17, 2001: Earthfield variations.

B.12 Sunday March 18, 2001

B.12.1 Overview Plots: System Performance, Temperatures and Earthfield Variations.

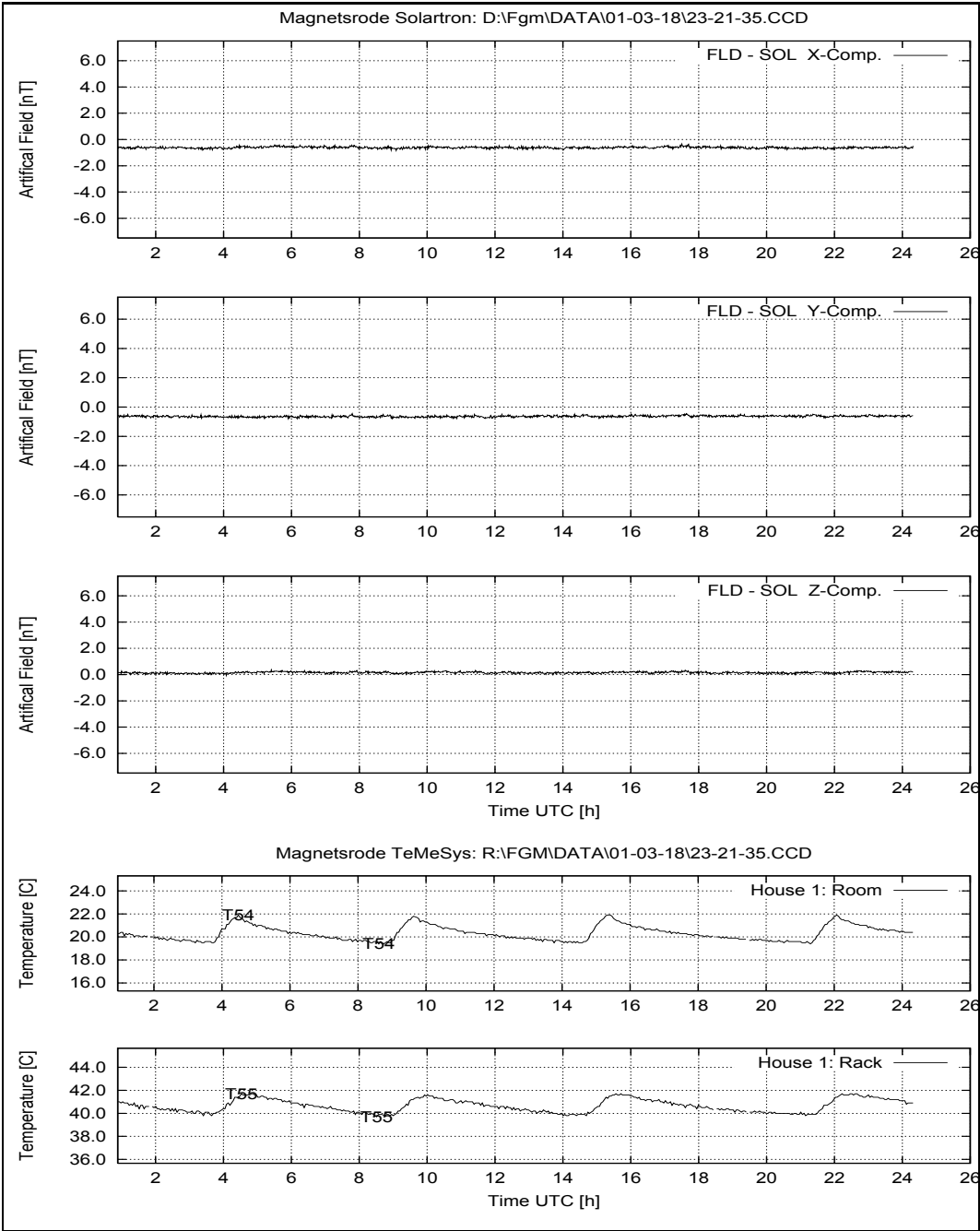

Figure 217: March 18, 2001: System Performance: FLD – SOL; Temperatures at House 1.

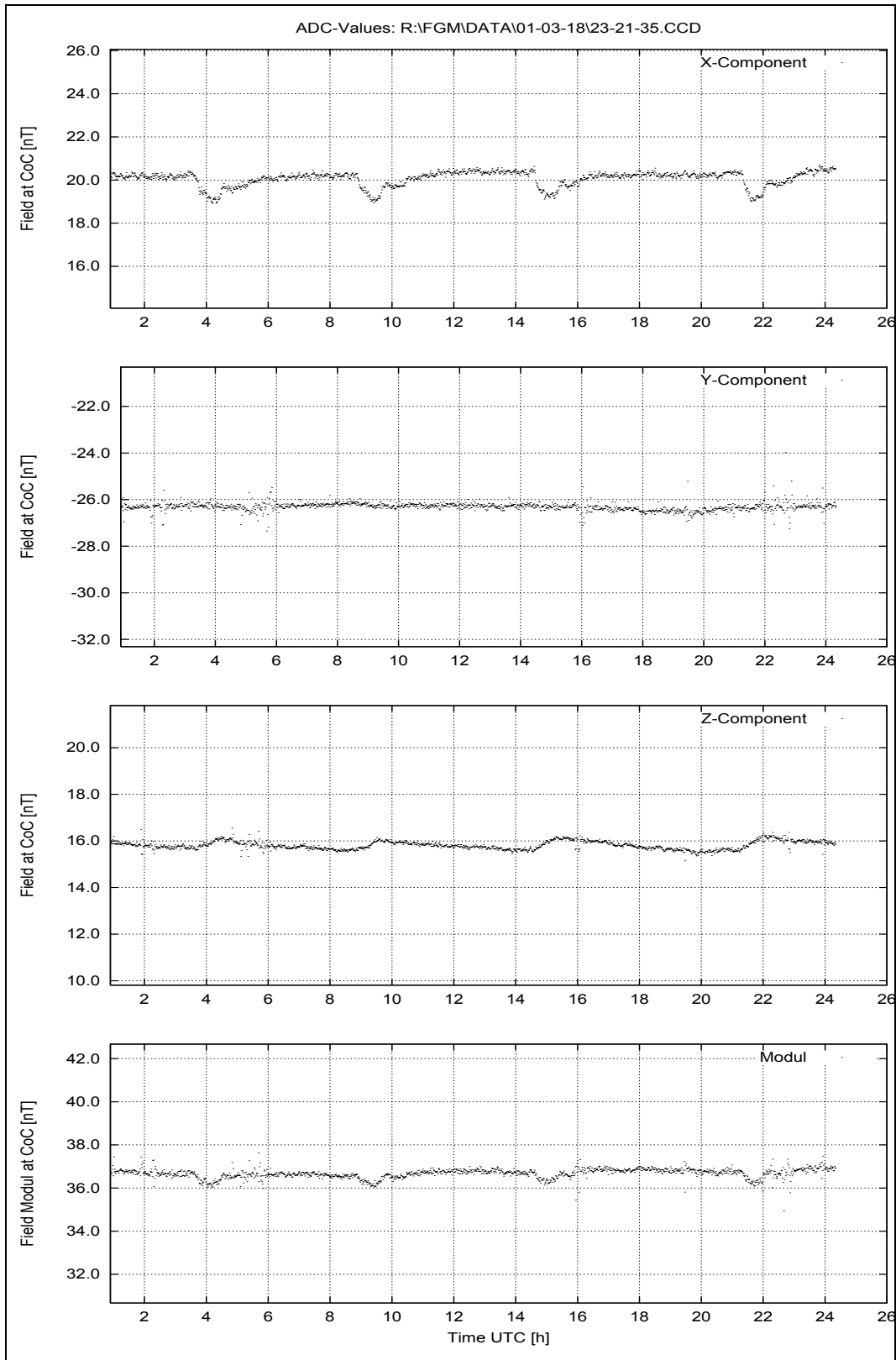

Figure 218: March 18, 2001: Zero field at CoC.

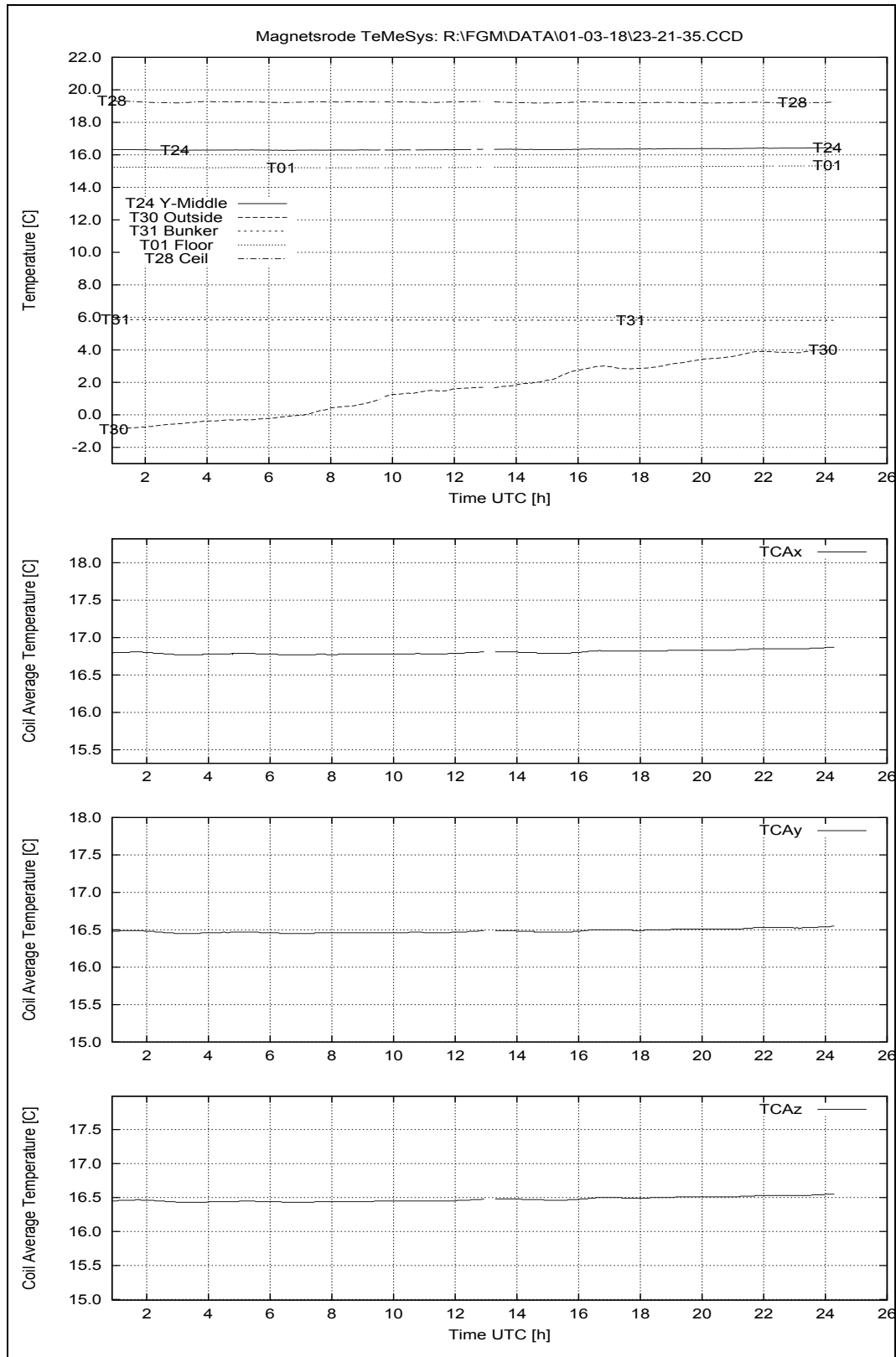

Figure 219: March 18, 2001: Temperatures House 2.

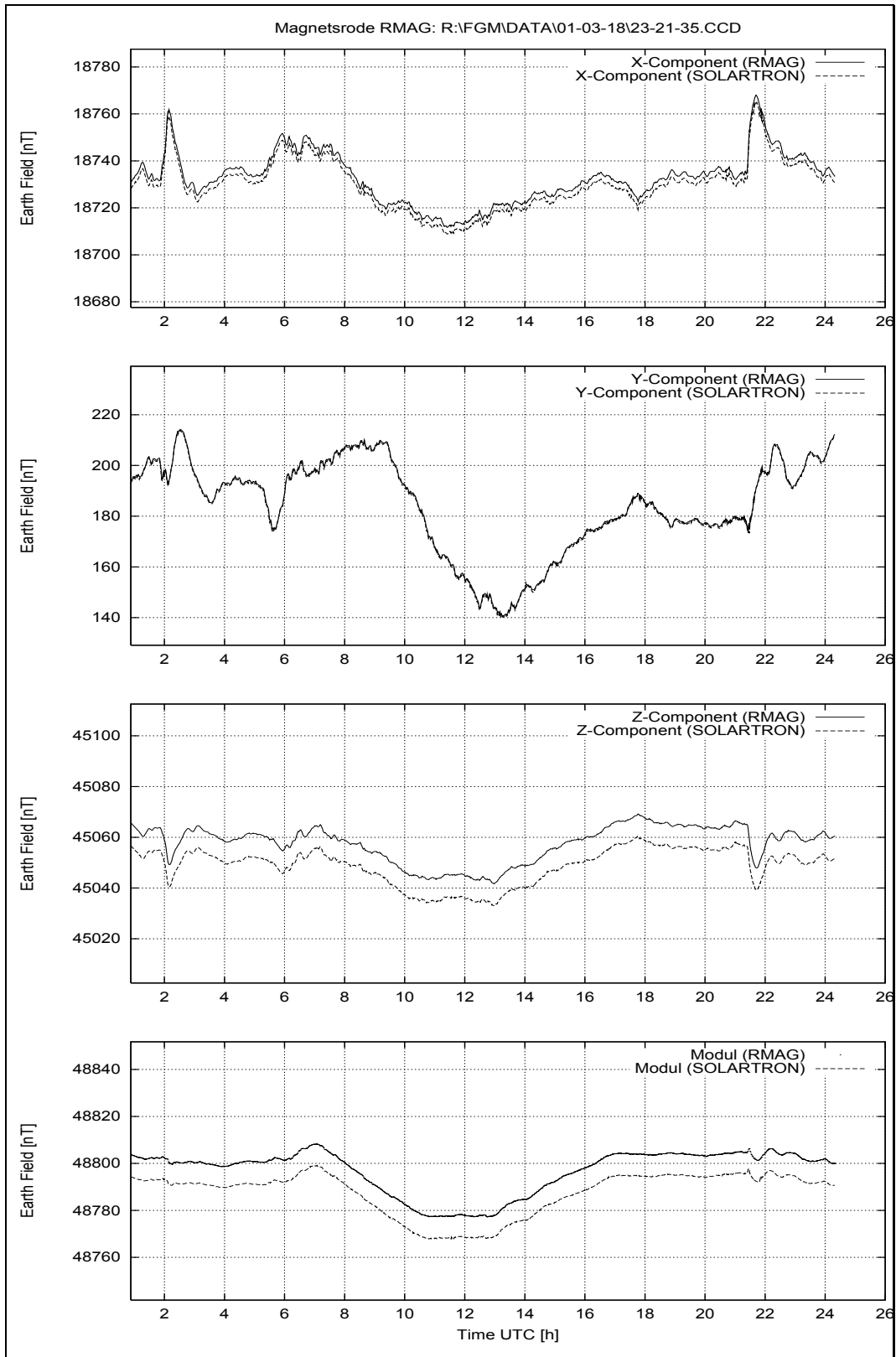

Figure 220: March 18, 2001: Earthfield variations.

R O S E T T A		Document: RO-IGM-TR-0002
		Issue: 2
		Revision: 2
IGM	Institut für Geophysik und Meteorologie	Date: October 10, 2001
	Technische Universität Braunschweig	Page: 303

C File Info Tables

The following tables gave a reference of the recorded *.CCD data file and the configuration file for that measurement. A specific calibration step data file can be looked up easily using these tables. The data are organized day by day.

C.1 CD-ROM

The complete data set as well as the calibration report, the analysis report and some other stuff is available on the CD-ROMs with the following described content.

ROSETTA 1-1			ROSETTA 2-1		ROSETTA 3-1	
01-03-08	01-03-14	01-03-20	01-03-23	01-03-28	01-04-05	
01-03-09	01-03-15	01-03-21	01-03-24	01-03-29	01-04-06	
01-03-10	01-03-16	01-03-22	01-03-25			
01-03-11	01-03-17	01-03-23	01-03-26		01-04-20	
01-03-12	01-03-18	(partial)	01-03-27		01-04-21	
01-03-13	01-03-19				01-04-22	

ROSETTA 4-1		ROSETTA 5-1		ROSETTA 6-1	
01-04-23	01-04-27	01-04-30	Miscelleaneous	01-08-28	01-09-01
01-04-24	01-04-28	01-05-01	Images	01-08-29	01-09-02
01-04-25	01-04-29	01-05-02	Materials	01-08-30	
01-04-26			Documentation	01-08-31	

ROSETTA 7-1	
01-09-03	01-09-10
01-09-06	01-09-11
01-09-07	01-09-12
01-09-08	01-09-13
01-09-09	

C.2 01-03-08

Configuration File	CCD File	Configuration File	CCD File
STABall.CFG	01-03-08\10-03-48.CCD	STABall.CFG	01-03-08\17-54-48.CCD
STABall.CFG	01-03-08\11-02-59.CCD	STABall.CFG	01-03-08\18-53-28.CCD
STABall.CFG	01-03-08\12-01-40.CCD	STABall.CFG	01-03-08\19-52-08.CCD
STABall.CFG	01-03-08\13-01-11.CCD	STABall.CFG	01-03-08\20-50-49.CCD
STABall.CFG	01-03-08\13-59-52.CCD	STABall.CFG	01-03-08\21-49-30.CCD
STABall.CFG	01-03-08\14-58-31.CCD	STABall.CFG	01-03-08\22-48-10.CCD
STABall.CFG	01-03-08\15-57-12.CCD	STABall.CFG	01-03-08\23-46-50.CCD
STABall.CFG	01-03-08\16-56-07.CCD		

C.3 01-03-09

Configuration File	CCD File	Configuration File	CCD File
STABall.CFG	01-03-09\00-45-31.CCD	STABall.CFG	01-03-09\12-29-36.CCD
STABall.CFG	01-03-09\01-44-10.CCD	STABall.CFG	01-03-09\13-28-15.CCD
STABall.CFG	01-03-09\02-42-52.CCD	STABall.CFG	01-03-09\14-26-56.CCD
STABall.CFG	01-03-09\03-41-32.CCD	STABall.CFG	01-03-09\15-25-37.CCD
STABall.CFG	01-03-09\04-40-13.CCD	STABall.CFG	01-03-09\16-24-18.CCD
STABall.CFG	01-03-09\05-38-54.CCD	STABall.CFG	01-03-09\17-22-58.CCD
STABall.CFG	01-03-09\06-37-34.CCD	STABall.CFG	01-03-09\18-21-38.CCD
STABall.CFG	01-03-09\07-36-15.CCD	STABall.CFG	01-03-09\19-20-19.CCD
STABall.CFG	01-03-09\08-34-55.CCD	STABall.CFG	01-03-09\20-18-59.CCD
STABall.CFG	01-03-09\09-33-35.CCD	STABall.CFG	01-03-09\21-17-40.CCD
STABall.CFG	01-03-09\10-32-15.CCD	STABall.CFG	01-03-09\22-16-20.CCD
STABall.CFG	01-03-09\11-30-56.CCD	STABall.CFG	01-03-09\23-15-12.CCD

C.4 01-03-10

Configuration File	CCD File	Configuration File	CCD File
STABall.CFG	01-03-10\00-13-52.CCD	STABall.CFG	01-03-10\12-57-30.CCD
STABall.CFG	01-03-10\01-12-33.CCD	STABall.CFG	01-03-10\13-56-09.CCD
STABall.CFG	01-03-10\02-11-13.CCD	STABall.CFG	01-03-10\14-54-50.CCD
STABall.CFG	01-03-10\03-09-53.CCD	STABall.CFG	01-03-10\15-53-29.CCD
STABall.CFG	01-03-10\04-08-33.CCD	STABall.CFG	01-03-10\16-52-09.CCD
STABall.CFG	01-03-10\05-07-14.CCD	STABall.CFG	01-03-10\17-50-49.CCD
STABall.CFG	01-03-10\06-05-53.CCD	STABall.CFG	01-03-10\18-49-29.CCD
STABall.CFG	01-03-10\07-04-34.CCD	STABall.CFG	01-03-10\19-48-10.CCD
STABall.CFG	01-03-10\08-03-14.CCD	STABall.CFG	01-03-10\20-47-12.CCD
STABall.CFG	01-03-10\09-01-54.CCD	STABall.CFG	01-03-10\21-45-51.CCD
STABall.CFG	01-03-10\10-00-34.CCD	STABall.CFG	01-03-10\22-44-32.CCD
STABall.CFG	01-03-10\11-00-08.CCD	STABall.CFG	01-03-10\23-43-11.CCD
STABall.CFG	01-03-10\11-58-49.CCD		

C.5 01-03-11

Configuration File	CCD File	Configuration File	CCD File
STABall.CFG	01-03-11\00-41-51.CCD	STABall.CFG	01-03-11\12-25-45.CCD
STABall.CFG	01-03-11\01-40-30.CCD	STABall.CFG	01-03-11\13-24-25.CCD
STABall.CFG	01-03-11\02-39-10.CCD	STABall.CFG	01-03-11\14-23-04.CCD
STABall.CFG	01-03-11\03-37-49.CCD	STABall.CFG	01-03-11\15-21-44.CCD
STABall.CFG	01-03-11\04-36-29.CCD	STABall.CFG	01-03-11\16-20-23.CCD
STABall.CFG	01-03-11\05-35-09.CCD	STABall.CFG	01-03-11\17-19-03.CCD
STABall.CFG	01-03-11\06-33-48.CCD	STABall.CFG	01-03-11\18-17-43.CCD
STABall.CFG	01-03-11\07-32-27.CCD	STABall.CFG	01-03-11\19-16-23.CCD
STABall.CFG	01-03-11\08-31-07.CCD	STABall.CFG	01-03-11\20-15-02.CCD
STABall.CFG	01-03-11\09-29-47.CCD	STABall.CFG	01-03-11\21-13-41.CCD
STABall.CFG	01-03-11\10-28-27.CCD	STABall.CFG	01-03-11\22-12-20.CCD
STABall.CFG	01-03-11\11-27-06.CCD	STABall.CFG	01-03-11\23-10-59.CCD

C.6 01-03-12

Configuration File	CCD File	Configuration File	CCD File
STABall.CFG	01-03-12\00-09-39.CCD	STABall.CFG	01-03-12\12-52-37.CCD
STABall.CFG	01-03-12\01-08-19.CCD	STABall.CFG	01-03-12\13-51-17.CCD
STABall.CFG	01-03-12\02-06-58.CCD	STABall.CFG	01-03-12\14-49-56.CCD
STABall.CFG	01-03-12\03-05-37.CCD	STABall.CFG	01-03-12\15-48-35.CCD
STABall.CFG	01-03-12\04-04-41.CCD	STABall.CFG	01-03-12\16-47-14.CCD
STABall.CFG	01-03-12\05-03-21.CCD	STABall.CFG	01-03-12\17-45-54.CCD
STABall.CFG	01-03-12\06-02-01.CCD	STABall.CFG	01-03-12\18-44-34.CCD
STABall.CFG	01-03-12\07-00-41.CCD	STABall.CFG	01-03-12\19-43-13.CCD
STABall.CFG	01-03-12\07-59-20.CCD	STABall.CFG	01-03-12\20-41-52.CCD
STABall.CFG	01-03-12\08-58-00.CCD	STABall.CFG	01-03-12\21-40-31.CCD
STABall.CFG	01-03-12\09-56-40.CCD	STABall.CFG	01-03-12\22-39-10.CCD
STABall.CFG	01-03-12\10-55-19.CCD	STABall.CFG	01-03-12\23-37-50.CCD
STABall.CFG	01-03-12\11-53-58.CCD		

C.7 01-03-13

Configuration File	CCD File	Configuration File	CCD File
STABall.CFG	01-03-13\00-36-29.CCD	STABall.CFG	01-03-13\12-20-23.CCD
STABall.CFG	01-03-13\01-35-08.CCD	STABall.CFG	01-03-13\13-19-02.CCD
STABall.CFG	01-03-13\02-33-48.CCD	STABall.CFG	01-03-13\14-17-42.CCD
STABall.CFG	01-03-13\03-32-27.CCD	STABall.CFG	01-03-13\15-16-22.CCD
STABall.CFG	01-03-13\04-31-06.CCD	STABall.CFG	01-03-13\16-15-02.CCD
STABall.CFG	01-03-13\05-29-45.CCD	STABall.CFG	01-03-13\17-13-41.CCD
STABall.CFG	01-03-13\06-28-24.CCD	STABall.CFG	01-03-13\18-12-21.CCD
STABall.CFG	01-03-13\07-27-04.CCD	STABall.CFG	01-03-13\19-11-01.CCD
STABall.CFG	01-03-13\08-25-43.CCD	STABall.CFG	01-03-13\20-09-41.CCD
STABall.CFG	01-03-13\09-24-23.CCD	STABall.CFG	01-03-13\21-08-20.CCD
STABall.CFG	01-03-13\10-23-03.CCD	STABall.CFG	01-03-13\22-07-00.CCD
STABall.CFG	01-03-13\11-21-43.CCD	STABall.CFG	01-03-13\23-05-39.CCD

C.8 01-03-14

Configuration File	CCD File	Configuration File	CCD File
STABall.CFG	01-03-14\00-04-19.CCD	STABall.CFG	01-03-14\12-46-55.CCD
STABall.CFG	01-03-14\01-02-58.CCD	STABall.CFG	01-03-14\13-45-34.CCD
STABall.CFG	01-03-14\02-01-38.CCD	STABall.CFG	01-03-14\14-44-13.CCD
STABall.CFG	01-03-14\03-00-18.CCD	STABall.CFG	01-03-14\15-42-53.CCD
STABall.CFG	01-03-14\03-58-58.CCD	STABall.CFG	01-03-14\16-41-33.CCD
STABall.CFG	01-03-14\04-57-38.CCD	STABall.CFG	01-03-14\17-40-12.CCD
STABall.CFG	01-03-14\05-56-17.CCD	STABall.CFG	01-03-14\18-38-51.CCD
STABall.CFG	01-03-14\06-54-56.CCD	STABall.CFG	01-03-14\19-37-31.CCD
STABall.CFG	01-03-14\07-53-35.CCD	STABall.CFG	01-03-14\20-36-11.CCD
STABall.CFG	01-03-14\08-52-15.CCD	STABall.CFG	01-03-14\21-34-50.CCD
STABall.CFG	01-03-14\09-50-55.CCD	STABall.CFG	01-03-14\22-33-30.CCD
STABall.CFG	01-03-14\10-49-35.CCD	STABall.CFG	01-03-14\23-32-10.CCD
STABall.CFG	01-03-14\11-48-15.CCD		

C.9 01-03-15

Configuration File	CCD File	Configuration File	CCD File
STABall.CFG	01-03-15\00-30-49.CCD	STABall.CFG	01-03-15\13-13-20.CCD
STABall.CFG	01-03-15\01-29-29.CCD	STABall.CFG	01-03-15\14-12-00.CCD
STABall.CFG	01-03-15\02-28-08.CCD	STABall.CFG	01-03-15\15-10-40.CCD
STABall.CFG	01-03-15\03-26-47.CCD	STABall.CFG	01-03-15\16-09-19.CCD
STABall.CFG	01-03-15\04-25-27.CCD	STABall.CFG	01-03-15\17-07-58.CCD
STABall.CFG	01-03-15\05-24-06.CCD	STABall.CFG	01-03-15\18-06-38.CCD
STABall.CFG	01-03-15\06-22-45.CCD	STABall.CFG	01-03-15\19-05-18.CCD
STABall.CFG	01-03-15\07-21-25.CCD	STABall.CFG	01-03-15\20-03-57.CCD
STABall.CFG	01-03-15\08-20-04.CCD	STABall.CFG	01-03-15\21-02-37.CCD
STABall.CFG	01-03-15\09-18-44.CCD	STABall.CFG	01-03-15\22-01-16.CCD
STABall.CFG	01-03-15\10-17-23.CCD	STABall.CFG	01-03-15\22-59-56.CCD
STABall.CFG	01-03-15\11-16-02.CCD	STABall.CFG	01-03-15\23-58-36.CCD
STABall.CFG	01-03-15\12-14-41.CCD		

C.10 01-03-16

Configuration File	CCD File	Configuration File	CCD File
	01-03-16\00-57-16.CCD	STABall.CFG	01-03-16\12-41-08.CCD
STABall.CFG	01-03-16\01-55-56.CCD	STABall.CFG	01-03-16\13-39-48.CCD
STABall.CFG	01-03-16\02-54-35.CCD	STABall.CFG	01-03-16\14-38-28.CCD
STABall.CFG	01-03-16\03-53-15.CCD	STABall.CFG	01-03-16\15-37-07.CCD
STABall.CFG	01-03-16\04-51-53.CCD	STABall.CFG	01-03-16\16-35-47.CCD
STABall.CFG	01-03-16\05-50-33.CCD	STABall.CFG	01-03-16\17-34-27.CCD
STABall.CFG	01-03-16\06-49-12.CCD	STABall.CFG	01-03-16\18-33-06.CCD
STABall.CFG	01-03-16\07-47-52.CCD	STABall.CFG	01-03-16\19-31-45.CCD
STABall.CFG	01-03-16\08-46-31.CCD	STABall.CFG	01-03-16\20-30-25.CCD
STABall.CFG	01-03-16\09-45-10.CCD	STABall.CFG	01-03-16\21-29-05.CCD
STABall.CFG	01-03-16\10-43-49.CCD	STABall.CFG	01-03-16\22-27-44.CCD
STABall.CFG	01-03-16\11-42-30.CCD	STABall.CFG	01-03-16\23-26-23.CCD

<h1 style="margin: 0;">R O S E T T A</h1>	Document: RO-IGM-TR-0002 Issue: 2 Revision: 2 Date: October 10, 2001 Page: 308
IGM	Institut für Geophysik und Meteorologie Technische Universität Braunschweig

C.11 01-03-17

Configuration File	CCD File	Configuration File	CCD File
STABall.CFG	01-03-17\00-25-03.CCD	STABall.CFG	01-03-17\12-08-59.CCD
STABall.CFG	01-03-17\01-23-42.CCD	STABall.CFG	01-03-17\13-07-38.CCD
STABall.CFG	01-03-17\02-22-21.CCD	STABall.CFG	01-03-17\14-06-17.CCD
STABall.CFG	01-03-17\03-21-01.CCD	STABall.CFG	01-03-17\15-04-57.CCD
STABall.CFG	01-03-17\04-19-40.CCD	STABall.CFG	01-03-17\16-03-37.CCD
STABall.CFG	01-03-17\05-18-19.CCD	STABall.CFG	01-03-17\17-02-17.CCD
STABall.CFG	01-03-17\06-16-59.CCD	STABall.CFG	01-03-17\18-01-52.CCD
STABall.CFG	01-03-17\07-15-39.CCD	STABall.CFG	01-03-17\19-00-31.CCD
STABall.CFG	01-03-17\08-14-21.CCD	STABall.CFG	01-03-17\19-59-12.CCD
STABall.CFG	01-03-17\09-13-00.CCD	STABall.CFG	01-03-17\20-57-51.CCD
STABall.CFG	01-03-17\10-11-40.CCD	STABall.CFG	01-03-17\21-56-31.CCD
STABall.CFG	01-03-17\11-10-19.CCD	STABall.CFG	01-03-17\22-55-11.CCD
STABall.CFG	01-03-17\12-08-59.CCD	STABall.CFG	01-03-17\23-53-51.CCD

C.12 01-03-18

Configuration File	CCD File	Configuration File	CCD File
STABall.CFG	01-03-18\00-52-30.CCD	STABall.CFG	01-03-18\12-36-22.CCD
STABall.CFG	01-03-18\01-51-09.CCD	STABall.CFG	01-03-18\13-35-01.CCD
STABall.CFG	01-03-18\02-49-49.CCD	STABall.CFG	01-03-18\14-33-41.CCD
STABall.CFG	01-03-18\03-48-29.CCD	STABall.CFG	01-03-18\15-32-21.CCD
STABall.CFG	01-03-18\04-47-08.CCD	STABall.CFG	01-03-18\16-31-00.CCD
STABall.CFG	01-03-18\05-45-48.CCD	STABall.CFG	01-03-18\17-29-40.CCD
STABall.CFG	01-03-18\06-44-27.CCD	STABall.CFG	01-03-18\18-28-20.CCD
STABall.CFG	01-03-18\07-43-06.CCD	STABall.CFG	01-03-18\19-26-59.CCD
STABall.CFG	01-03-18\08-41-45.CCD	STABall.CFG	01-03-18\20-25-38.CCD
STABall.CFG	01-03-18\09-40-25.CCD	STABall.CFG	01-03-18\21-24-17.CCD
STABall.CFG	01-03-18\10-39-04.CCD	STABall.CFG	01-03-18\22-22-56.CCD
STABall.CFG	01-03-18\11-37-43.CCD	STABall.CFG	01-03-18\23-21-35.CCD

C.13 01-03-19

Configuration File	CCD File	Configuration File	CCD File
STABall.CFG	01-03-19\00-20-15.CCD	ALI10.cfg	01-03-19\15-29-16.CCD
STABall.CFG	01-03-19\01-18-55.CCD	OFFX_T1.cfg	01-03-19\15-36-45.CCD
STABall.CFG	01-03-19\02-17-35.CCD	OFFX_T1.cfg	01-03-19\15-42-39.CCD
STABall.CFG	01-03-19\03-16-15.CCD	ALI10.cfg	01-03-19\15-53-19.CCD
STABall.CFG	01-03-19\04-14-54.CCD	OFFZ_T1.cfg	01-03-19\16-00-30.CCD
STABall.CFG	01-03-19\05-14-11.CCD	OFFZ_T1.cfg	01-03-19\16-07-30.CCD
STABall.CFG	01-03-19\06-12-51.CCD	ALI10.cfg	01-03-19\16-23-48.CCD
STABall.CFG	01-03-19\07-11-31.CCD	14000XYZ.CFG	01-03-19\16-31-23.CCD
STABall.CFG	01-03-19\08-10-11.CCD	LX15.CFG	01-03-19\17-04-04.CCD
STABall.CFG	01-03-19\09-08-51.CCD	LY15.CFG	01-03-19\17-35-25.CCD
STABall.CFG	01-03-19\10-07-31.CCD	LZ15.CFG	01-03-19\18-06-26.CCD
STABall.CFG	01-03-19\11-06-10.CCD	SP15.CFG	01-03-19\18-37-27.CCD
STABall.CFG	01-03-19\12-04-49.CCD	14000XYZ.CFG	01-03-19\20-21-50.CCD
		LX15.CFG	01-03-19\20-54-30.CCD
ALI10.cfg	01-03-19\15-01-03.CCD	LY15.CFG	01-03-19\21-25-30.CCD
OFFX_N1.cfg	01-03-19\15-08-30.CCD	LZ15.CFG	01-03-19\21-56-30.CCD
OFFX_N1.cfg	01-03-19\15-12-37.CCD	SP15.CFG	01-03-19\22-27-31.CCD

C.14 01-03-20

Configuration File	CCD File	Configuration File	CCD File
14000XYZ.CFG	01-03-20\00-11-53.CCD	LZ15.CFG	01-03-20\05-36-52.CCD
LX15.CFG	01-03-20\00-44-33.CCD	SP15.CFG	01-03-20\06-07-53.CCD
LY15.CFG	01-03-20\01-15-51.CCD	14000XYZ.CFG	01-03-20\07-52-14.CCD
LZ15.CFG	01-03-20\01-46-51.CCD	LX15.CFG	01-03-20\08-25-24.CCD
SP15.CFG	01-03-20\02-17-51.CCD	LY15.CFG	01-03-20\08-56-24.CCD
14000XYZ.CFG	01-03-20\04-02-13.CCD	LZ15.CFG	01-03-20\09-27-25.CCD
LX15.CFG	01-03-20\04-34-53.CCD	SP15.CFG	01-03-20\09-58-26.CCD
LY15.CFG	01-03-20\05-05-52.CCD		

C.15 01-03-21

Configuration File	CCD File	Configuration File	CCD File
ALI10.cfg	01-03-21\12-58-42.CCD	LX15.CFG	01-03-21\19-10-11.CCD
STABTST.cfg	01-03-21\13-06-10.CCD	LY15.CFG	01-03-21\19-41-11.CCD
STABTST.cfg	01-03-21\14-06-50.CCD	LZ15.CFG	01-03-21\20-12-11.CCD
STABTST.cfg	01-03-21\15-07-30.CCD	SP15spir.CFG	01-03-21\20-43-12.CCD
STABTST.cfg	01-03-21\16-08-10.CCD		
STABTST.cfg	01-03-21\17-08-50.CCD		
STABTST.cfg	01-03-21\18-09-30.CCD		

C.16 01-03-22

Configuration File	CCD File	Configuration File	CCD File
SP15sphe.CFG	01-03-22\00-35-57.CCD	STABTST.cfg	01-03-22\14-53-26.CCD
LX15.CFG	01-03-22\05-08-37.CCD	STABTST.cfg	01-03-22\15-54-07.CCD
LY15.CFG	01-03-22\05-39-37.CCD	STABTST.cfg	01-03-22\16-54-49.CCD
LZ15.CFG	01-03-22\06-10-38.CCD	STABTST.cfg	01-03-22\17-55-30.CCD
SP15sphe.CFG	01-03-22\06-41-38.CCD	LX15.CFG	01-03-22\18-56-10.CCD
ALI10.cfg	01-03-22\12-44-38.CCD	LY15.CFG	01-03-22\19-27-12.CCD
STABTST.cfg	01-03-22\12-52-04.CCD	LZ15.CFG	01-03-22\19-58-13.CCD
STABTST.cfg	01-03-22\13-52-45.CCD	SP15spir.CFG	01-03-22\20-29-13.CCD

C.17 01-03-23

Configuration File	CCD File	Configuration File	CCD File
SP15sphe.CFG	01-03-23\00-21-58.CCD	ali10.CFG	01-03-23\13-58-41.CCD
LX15.CFG	01-03-23\04-54-38.CCD	TEMP.CFG	01-03-23\14-05-56.CCD
LY15.CFG	01-03-23\05-25-39.CCD	TEMP.CFG	01-03-23\15-13-37.CCD
LZ15.CFG	01-03-23\05-58-17.CCD	TEMP.CFG	01-03-23\16-21-17.CCD
SP15sphe.CFG	01-03-23\06-29-17.CCD	TEMP.CFG	01-03-23\17-28-58.CCD
ALI10.cfg	01-03-23\12-21-23.CCD	TEMP.CFG	01-03-23\18-36-39.CCD
TX15.CFG	01-03-23\12-40-29.CCD	TEMP.CFG	01-03-23\19-44-20.CCD
TY15.CFG	01-03-23\12-53-30.CCD	TEMP.CFG	01-03-23\20-52-00.CCD
TZ15.CFG	01-03-23\13-06-31.CCD	TEMP.CFG	01-03-23\21-59-40.CCD
14000XYZ.CFG	01-03-23\13-26-01.CCD	TEMP.CFG	01-03-23\23-07-21.CCD

C.18 01-03-24

Configuration File	CCD File	Configuration File	CCD File
TEMP.CFG	01-03-24\00-15-02.CCD	TEMP.CFG	01-03-24\12-40-17.CCD
TEMP.CFG	01-03-24\01-22-43.CCD	TEMP.CFG	01-03-24\13-47-57.CCD
TEMP.CFG	01-03-24\02-30-23.CCD	TEMP.CFG	01-03-24\14-55-38.CCD
TEMP.CFG	01-03-24\03-38-04.CCD	TEMP.CFG	01-03-24\16-03-18.CCD
TEMP.CFG	01-03-24\04-45-45.CCD	TEMP.CFG	01-03-24\17-10-59.CCD
TEMP.CFG	01-03-24\05-53-25.CCD	TEMP.CFG	01-03-24\18-18-38.CCD
TEMP.CFG	01-03-24\07-01-06.CCD	TEMP.CFG	01-03-24\19-26-18.CCD
TEMP.CFG	01-03-24\08-08-46.CCD	TEMP.CFG	01-03-24\20-33-59.CCD
TEMP.CFG	01-03-24\09-16-46.CCD	TEMP.CFG	01-03-24\21-41-40.CCD
TEMP.CFG	01-03-24\10-24-56.CCD	TEMP.CFG	01-03-24\22-49-20.CCD
TEMP.CFG	01-03-24\11-32-36.CCD	TEMP.CFG	01-03-24\23-57-00.CCD

C.19 01-03-25

Configuration File	CCD File	Configuration File	CCD File
TEMP.CFG	01-03-25\01-04-41.CCD	TEMP.CFG	01-03-25\13-29-06.CCD
TEMP.CFG	01-03-25\02-12-20.CCD	TEMP.CFG	01-03-25\14-45-21.CCD
TEMP.CFG	01-03-25\03-20-02.CCD	TEMP.CFG	01-03-25\15-53-01.CCD
TEMP.CFG	01-03-25\04-27-43.CCD	TEMP.CFG	01-03-25\17-00-41.CCD
TEMP.CFG	01-03-25\05-35-23.CCD	TEMP.CFG	01-03-25\18-08-22.CCD
TEMP.CFG	01-03-25\06-43-03.CCD	TEMP.CFG	01-03-25\19-16-02.CCD
TEMP.CFG	01-03-25\07-50-44.CCD	TEMP.CFG	01-03-25\20-23-42.CCD
TEMP.CFG	01-03-25\08-58-24.CCD	TEMP.CFG	01-03-25\21-31-23.CCD
TEMP.CFG	01-03-25\10-06-05.CCD	TEMP.CFG	01-03-25\22-39-04.CCD
TEMP.CFG	01-03-25\11-13-44.CCD	TEMP.CFG	01-03-25\23-46-45.CCD
TEMP.CFG	01-03-25\12-21-25.CCD		

C.20 01-03-26

Configuration File	CCD File	Configuration File	CCD File
TEMP.CFG	01-03-26\00-54-26.CCD	TEMP.CFG	01-03-26\13-19-10.CCD
TEMP.CFG	01-03-26\02-02-06.CCD	TEMP.CFG	01-03-26\14-26-51.CCD
TEMP.CFG	01-03-26\03-09-46.CCD	TEMP.CFG	01-03-26\15-34-32.CCD
TEMP.CFG	01-03-26\04-17-27.CCD	TEMP.CFG	01-03-26\16-42-12.CCD
TEMP.CFG	01-03-26\05-25-28.CCD	TEMP.CFG	01-03-26\17-49-53.CCD
TEMP.CFG	01-03-26\06-33-08.CCD	TEMP.CFG	01-03-26\18-57-34.CCD
TEMP.CFG	01-03-26\07-40-49.CCD	TEMP.CFG	01-03-26\20-05-15.CCD
TEMP.CFG	01-03-26\08-48-29.CCD	TEMP.CFG	01-03-26\21-12-54.CCD
TEMP.CFG	01-03-26\09-56-08.CCD	TEMP.CFG	01-03-26\22-20-35.CCD
TEMP.CFG	01-03-26\11-03-49.CCD	TEMP.CFG	01-03-26\23-28-15.CCD
TEMP.CFG	01-03-26\12-11-29.CCD		

R O S E T T A		Document: RO-IGM-TR-0002
IGM Institut für Geophysik und Meteorologie Technische Universität Braunschweig		Issue: 2
		Revision: 2
		Date: October 10, 2001
		Page: 312

C.21 01-03-27

Configuration File	CCD File	Configuration File	CCD File
TEMP.CFG	01-03-27\00-36-28.CCD	TEMP.CFG	01-03-27\13-00-55.CCD
TEMP.CFG	01-03-27\01-44-09.CCD	TEMP.CFG	01-03-27\14-08-35.CCD
TEMP.CFG	01-03-27\02-51-49.CCD	TEMP.CFG	01-03-27\15-16-15.CCD
TEMP.CFG	01-03-27\03-59-29.CCD	TEMP.CFG	01-03-27\16-23-55.CCD
TEMP.CFG	01-03-27\05-07-10.CCD	TEMP.CFG	01-03-27\17-31-36.CCD
TEMP.CFG	01-03-27\06-14-51.CCD	TEMP.CFG	01-03-27\18-39-17.CCD
TEMP.CFG	01-03-27\07-22-32.CCD	TEMP.CFG	01-03-27\19-46-57.CCD
TEMP.CFG	01-03-27\08-30-12.CCD	TEMP.CFG	01-03-27\20-54-36.CCD
TEMP.CFG	01-03-27\09-37-52.CCD	TEMP.CFG	01-03-27\22-02-17.CCD
TEMP.CFG	01-03-27\10-45-33.CCD	TEMP.CFG	01-03-27\23-09-57.CCD
TEMP.CFG	01-03-27\11-53-14.CCD		

C.22 01-03-28

Configuration File	CCD File	Configuration File	CCD File
TEMP.CFG	01-03-28\00-17-38.CCD	VAR.CFG	01-03-28\10-59-36.CCD
TEMP.CFG	01-03-28\01-25-17.CCD	VAR.CFG	01-03-28\12-00-18.CCD
TEMP.CFG	01-03-28\02-32-59.CCD	VAR.CFG	01-03-28\13-00-59.CCD
TEMP.CFG	01-03-28\03-40-40.CCD	VAR.CFG	01-03-28\14-01-40.CCD
TEMP.CFG	01-03-28\04-48-44.CCD	VAR.CFG	01-03-28\15-02-20.CCD
TEMP.CFG	01-03-28\05-56-26.CCD	VAR.CFG	01-03-28\16-03-01.CCD
TEMP.CFG	01-03-28\07-04-05.CCD	VAR.CFG	01-03-28\17-03-42.CCD
TEMP.CFG	01-03-28\08-11-46.CCD	VAR.CFG	01-03-28\18-04-22.CCD
ali10.CFG	01-03-28\08-56-45.CCD	VAR.CFG	01-03-28\19-05-03.CCD
TX15.CFG	01-03-28\09-03-55.CCD	VAR.CFG	01-03-28\20-05-44.CCD
TY15.CFG	01-03-28\09-16-55.CCD	VAR.CFG	01-03-28\21-06-24.CCD
TZ15.CFG	01-03-28\09-29-55.CCD	VAR.CFG	01-03-28\22-07-05.CCD
ali10.CFG	01-03-28\09-51-44.CCD	VAR.CFG	01-03-28\23-07-46.CCD
VAR.CFG	01-03-28\09-58-54.CCD		

C.23 01-03-29

Configuration File	CCD File	Configuration File	CCD File
VAR.CFG	01-03-29\00-08-26.CCD	VAR.CFG	01-03-29\08-13-54.CCD
VAR.CFG	01-03-29\01-09-06.CCD	VAR.CFG	01-03-29\09-14-35.CCD
VAR.CFG	01-03-29\02-09-48.CCD	VAR.CFG	01-03-29\10-15-16.CCD
VAR.CFG	01-03-29\03-10-29.CCD	VAR.CFG	01-03-29\11-15-56.CCD
VAR.CFG	01-03-29\04-11-11.CCD	VAR.CFG	01-03-29\12-16-37.CCD
VAR.CFG	01-03-29\05-11-52.CCD	VAR.CFG	01-03-29\13-17-17.CCD
VAR.CFG	01-03-29\06-12-33.CCD	VAR.CFG	01-03-29\14-17-58.CCD
VAR.CFG	01-03-29\07-13-14.CCD		

C.24 01-04-05

Configuration File	CCD File	Configuration File	CCD File
ali10.CFG	01-04-05\09-34-37.CCD	fd_H.CFG	01-04-05\10-53-16.CCD
offx_N1.CFG	01-04-05\09-42-17.CCD	fd_L.CFG	01-04-05\11-40-37.CCD
offx_N1.CFG	01-04-05\09-46-47.CCD	ALI10.cfg	01-04-05\12-59-59.CCD
ALI10.CFG	01-04-05\09-51-50.CCD	LX15.CFG	01-04-05\13-08-09.CCD
offx_t1.CFG	01-04-05\09-59-00.CCD	LY15.CFG	01-04-05\13-39-12.CCD
offx_t1.CFG	01-04-05\10-06-02.CCD	LZ15.CFG	01-04-05\14-10-13.CCD
ali10.CFG	01-04-05\10-15-05.CCD	SP15spir.CFG	01-04-05\14-41-13.CCD
offz_t1.CFG	01-04-05\10-22-15.CCD	SP15sphe.CFG	01-04-05\18-33-57.CCD
offz_t1.CFG	01-04-05\10-29-10.CCD	LX15.CFG	01-04-05\23-06-37.CCD
ali10.CFG	01-04-05\10-45-49.CCD	LY15.CFG	01-04-05\23-37-38.CCD

C.25 01-04-06

Configuration File	CCD File	Configuration File	CCD File
LZ15.CFG	01-04-06\00-08-38.CCD	LY15.CFG	01-04-06\07-56-49.CCD
SP15sphe.CFG	01-04-06\00-39-39.CCD	LZ15.CFG	01-04-06\08-27-52.CCD
ALI10.cfg	01-04-06\07-18-23.CCD	SP15spir.CFG	01-04-06\08-58-51.CCD
LX15.CFG	01-04-06\07-25-45.CCD		

C.26 01-04-20

Configuration File	CCD File	Configuration File	CCD File
ALI10.cfg	01-04-20\08-53-39.CCD	ALI10.cfg	01-04-20\12-00-24.CCD
fd_h.CFG	01-04-20\09-01-12.CCD	STABTST.cfg	01-04-20\12-07-49.CCD
fd_l.CFG	01-04-20\09-48-34.CCD	STABTST.cfg	01-04-20\13-08-30.CCD
PWR_VAR.cfg	01-04-20\10-49-54.CCD	LX15.CFG	01-04-20\14-09-12.CCD
PWR_VAR.cfg	01-04-20\10-58-12.CCD	LY15.CFG	01-04-20\14-40-13.CCD
PWR_VAR.cfg	01-04-20\11-03-07.CCD	LZ15.CFG	01-04-20\15-11-14.CCD
PWR_VAR.cfg	01-04-20\11-07-39.CCD	SP15spir.CFG	01-04-20\15-42-14.CCD
PWR_VAR.cfg	01-04-20\11-12-51.CCD	SP15sphe.CFG	01-04-20\19-34-58.CCD
PWR_VAR.cfg	01-04-20\11-17-23.CCD		
PWR_VAR.cfg	01-04-20\11-22-01.CCD		

R O S E T T A		Document: RO-IGM-TR-0002
IGM Institut für Geophysik und Meteorologie Technische Universität Braunschweig		Issue: 2
		Revision: 2
		Date: October 10, 2001
		Page: 314

C.27 01-04-21

Configuration File	CCD File	Configuration File	CCD File
LX15.CFG	01-04-21\00-07-39.CCD	LZ15.CFG	01-04-21\12-31-22.CCD
LY15.CFG	01-04-21\00-38-39.CCD	SP15spir.CFG	01-04-21\13-02-23.CCD
LZ15.CFG	01-04-21\01-09-40.CCD	SP15sphe.CFG	01-04-21\16-55-08.CCD
SP15spir.CFG	01-04-21\01-40-40.CCD	LX15.CFG	01-04-21\21-27-48.CCD
SP15sphe.CFG	01-04-21\05-33-42.CCD	LY15.CFG	01-04-21\21-58-48.CCD
ALI10.cfg	01-04-21\11-21-57.CCD	LZ15.CFG	01-04-21\22-29-49.CCD
LX15.CFG	01-04-21\11-29-19.CCD	SP15spir.CFG	01-04-21\23-00-49.CCD
LY15.CFG	01-04-21\12-00-20.CCD		

C.28 01-04-22

Configuration File	CCD File	Configuration File	CCD File
SP15sphe.CFG	01-04-22\02-53-34.CCD	var.CFG	01-04-22\15-31-57.CCD
var.CFG	01-04-22\07-26-14.CCD	var.CFG	01-04-22\16-32-38.CCD
var.CFG	01-04-22\08-26-55.CCD	var.CFG	01-04-22\17-33-19.CCD
var.CFG	01-04-22\09-27-35.CCD	var.CFG	01-04-22\18-34-00.CCD
var.CFG	01-04-22\10-28-16.CCD	var.CFG	01-04-22\19-34-40.CCD
var.CFG	01-04-22\11-28-56.CCD	LX15.CFG	01-04-22\20-35-21.CCD
var.CFG	01-04-22\12-29-37.CCD	LY15.CFG	01-04-22\21-06-22.CCD
var.CFG	01-04-22\13-30-37.CCD	LZ15.CFG	01-04-22\21-37-22.CCD
var.CFG	01-04-22\14-31-17.CCD	SP15spir.CFG	01-04-22\22-08-23.CCD

C.29 01-04-23

Configuration File	CCD File	Configuration File	CCD File
SP15sphe.CFG	01-04-23\02-01-04.CCD	offz_t1.CFG	01-04-23\09-49-30.CCD
ALI10.cfg	01-04-23\07-00-01.CCD	ALI10.cfg	01-04-23\10-25-59.CCD
fd_h.CFG	01-04-23\07-07-33.CCD	STABTST.cfg	01-04-23\10-33-31.CCD
fd_l.CFG	01-04-23\07-54-55.CCD	STABTST.cfg	01-04-23\11-34-11.CCD
ALI10.cfg	01-04-23\08-53-30.CCD	LX15.CFG	01-04-23\12-34-52.CCD
offx_n1.CFG	01-04-23\09-01-01.CCD	LY15.CFG	01-04-23\13-06-15.CCD
offx_n1.CFG	01-04-23\09-04-58.CCD	LZ15.CFG	01-04-23\13-37-46.CCD
ALI10.cfg	01-04-23\09-10-36.CCD	SP15spir.CFG	01-04-23\14-09-10.CCD
offx_t1.CFG	01-04-23\09-17-46.CCD	SP15sphe.CFG	01-04-23\18-01-54.CCD
offx_t1.CFG	01-04-23\09-24-30.CCD	LX15.CFG	01-04-23\22-34-36.CCD
ALI10.cfg	01-04-23\09-34-59.CCD	LY15.CFG	01-04-23\23-05-35.CCD
offz_t1.CFG	01-04-23\09-42-09.CCD	LZ15.CFG	01-04-23\23-36-35.CCD

C.30 01-04-24

Configuration File	CCD File	Configuration File	CCD File
SP15spir.CFG	01-04-24\00-07-37.CCD	LY15.CFG	01-04-24\14-01-58.CCD
SP15sphe.CFG	01-04-24\04-00-21.CCD	LZ15.CFG	01-04-24\14-32-59.CCD
ALI10.cfg	01-04-24\11-22-15.CCD	SP15spir.CFG	01-04-24\15-03-59.CCD
STABTST.cfg	01-04-24\11-29-38.CCD	SP15sphe.CFG	01-04-24\18-56-42.CCD
STABTST.cfg	01-04-24\12-30-17.CCD	LX15.CFG	01-04-24\23-29-22.CCD
LX15.CFG	01-04-24\13-30-57.CCD		

C.31 01-04-25

Configuration File	CCD File	Configuration File	CCD File
LY15.CFG	01-04-25\00-00-24.CCD	offz_t1.CFG	01-04-25\14-15-35.CCD
LZ15.CFG	01-04-25\00-31-24.CCD	ALI10.cfg	01-04-25\14-38-48.CCD
SP15spir.CFG	01-04-25\01-02-24.CCD	fd_h.CFG	01-04-25\14-46-10.CCD
SP15sphe.CFG	01-04-25\04-55-08.CCD	fd_l.CFG	01-04-25\15-33-33.CCD
ALI10.cfg	01-04-25\11-20-48.CCD	fd_h.CFG	01-04-25\16-20-57.CCD
fd_h.CFG	01-04-25\11-28-26.CCD	fd_l.CFG	01-04-25\17-08-17.CCD
fd_l.CFG	01-04-25\12-15-47.CCD	fd_h.CFG	01-04-25\17-55-38.CCD
ALI10.cfg	01-04-25\13-19-54.CCD	fd_l.CFG	01-04-25\18-42-58.CCD
offx_n1.CFG	01-04-25\13-27-21.CCD	fd_h.CFG	01-04-25\19-30-18.CCD
offx_n1.CFG	01-04-25\13-32-01.CCD	fd_l.CFG	01-04-25\20-17-39.CCD
ALI10.cfg	01-04-25\13-38-17.CCD	fd_h.CFG	01-04-25\21-04-59.CCD
offx_t1.CFG	01-04-25\13-45-28.CCD	fd_l.CFG	01-04-25\21-52-20.CCD
offx_t1.CFG	01-04-25\13-53-02.CCD	fd_h.CFG	01-04-25\22-39-41.CCD
ALI10.cfg	01-04-25\14-01-34.CCD	fd_l.CFG	01-04-25\23-27-01.CCD
offz_t1.CFG	01-04-25\14-08-44.CCD		

C.32 01-04-26

Configuration File	CCD File	Configuration File	CCD File
fd_h.CFG	01-04-26\00-14-21.CCD	TZ15.CFG	01-04-26\10-31-11.CCD
fd_l.CFG	01-04-26\01-01-41.CCD	ali10.CFG	01-04-26\11-26-34.CCD
fd_h.CFG	01-04-26\01-49-02.CCD	TEMP.CFG	01-04-26\11-33-50.CCD
fd_l.CFG	01-04-26\02-36-22.CCD	TEMP.CFG	01-04-26\12-41-30.CCD
pwr_var.cfg	01-04-26\08-34-20.CCD	TEMP.CFG	01-04-26\13-49-11.CCD
pwr_var.cfg	01-04-26\08-40-18.CCD	TEMP.CFG	01-04-26\14-56-51.CCD
pwr_var.cfg	01-04-26\08-45-39.CCD	TEMP.CFG	01-04-26\16-04-32.CCD
pwr_var.cfg	01-04-26\08-50-44.CCD	TEMP.CFG	01-04-26\17-12-14.CCD
pwr_var.cfg	01-04-26\08-56-21.CCD	TEMP.CFG	01-04-26\18-19-55.CCD
pwr_var.cfg	01-04-26\09-01-17.CCD	TEMP.CFG	01-04-26\19-27-56.CCD
pwr_var.cfg	01-04-26\09-06-31.CCD	TEMP.CFG	01-04-26\20-35-37.CCD
ali10.CFG	01-04-26\09-57-42.CCD	TEMP.CFG	01-04-26\21-43-18.CCD
TX15.CFG	01-04-26\10-05-09.CCD	TEMP.CFG	01-04-26\22-50-58.CCD
TY15.CFG	01-04-26\10-18-10.CCD	TEMP.CFG	01-04-26\23-58-38.CCD

C.33 01-04-27

Configuration File	CCD File	Configuration File	CCD File
TEMP.CFG	01-04-27\01-06-18.CCD	TEMP.CFG	01-04-27\13-30-44.CCD
TEMP.CFG	01-04-27\02-13-58.CCD	TEMP.CFG	01-04-27\14-38-26.CCD
TEMP.CFG	01-04-27\03-21-38.CCD	TEMP.CFG	01-04-27\15-46-21.CCD
TEMP.CFG	01-04-27\04-29-18.CCD	TEMP.CFG	01-04-27\16-54-02.CCD
TEMP.CFG	01-04-27\05-36-57.CCD	TEMP.CFG	01-04-27\18-01-43.CCD
TEMP.CFG	01-04-27\06-44-38.CCD	TEMP.CFG	01-04-27\19-09-24.CCD
TEMP.CFG	01-04-27\07-52-19.CCD	TEMP.CFG	01-04-27\20-17-05.CCD
TEMP.CFG	01-04-27\09-00-03.CCD	TEMP.CFG	01-04-27\21-24-46.CCD
TEMP.CFG	01-04-27\10-07-43.CCD	TEMP.CFG	01-04-27\22-32-27.CCD
TEMP.CFG	01-04-27\11-15-23.CCD	TEMP.CFG	01-04-27\23-40-08.CCD
TEMP.CFG	01-04-27\12-23-04.CCD		

C.34 01-04-28

Configuration File	CCD File	Configuration File	CCD File
TEMP.CFG	01-04-28\00-47-48.CCD	TEMP.CFG	01-04-28\13-13-15.CCD
TEMP.CFG	01-04-28\01-55-28.CCD	TEMP.CFG	01-04-28\14-20-56.CCD
TEMP.CFG	01-04-28\03-03-08.CCD	TEMP.CFG	01-04-28\15-29-04.CCD
TEMP.CFG	01-04-28\04-10-49.CCD	TEMP.CFG	01-04-28\16-36-43.CCD
TEMP.CFG	01-04-28\05-19-21.CCD	TEMP.CFG	01-04-28\17-44-24.CCD
TEMP.CFG	01-04-28\06-27-01.CCD	TEMP.CFG	01-04-28\18-52-04.CCD
TEMP.CFG	01-04-28\07-34-41.CCD	TEMP.CFG	01-04-28\19-59-45.CCD
TEMP.CFG	01-04-28\08-42-21.CCD	TEMP.CFG	01-04-28\21-07-24.CCD
TEMP.CFG	01-04-28\09-50-02.CCD	TEMP.CFG	01-04-28\22-15-05.CCD
TEMP.CFG	01-04-28\10-57-42.CCD	TEMP.CFG	01-04-28\23-22-46.CCD
TEMP.CFG	01-04-28\12-05-35.CCD		

C.35 01-04-29

Configuration File	CCD File	Configuration File	CCD File
TEMP.CFG	01-04-29\00-30-27.CCD	TEMP.CFG	01-04-29\12-56-31.CCD
TEMP.CFG	01-04-29\01-38-06.CCD	TEMP.CFG	01-04-29\14-04-11.CCD
TEMP.CFG	01-04-29\02-45-47.CCD	TEMP.CFG	01-04-29\15-11-51.CCD
TEMP.CFG	01-04-29\03-53-28.CCD	TEMP.CFG	01-04-29\16-19-32.CCD
TEMP.CFG	01-04-29\05-01-09.CCD	TEMP.CFG	01-04-29\17-27-12.CCD
TEMP.CFG	01-04-29\06-08-50.CCD	TEMP.CFG	01-04-29\18-34-53.CCD
TEMP.CFG	01-04-29\07-16-31.CCD	TEMP.CFG	01-04-29\19-42-34.CCD
TEMP.CFG	01-04-29\08-25-50.CCD	TEMP.CFG	01-04-29\20-50-35.CCD
TEMP.CFG	01-04-29\09-33-30.CCD	TEMP.CFG	01-04-29\21-58-16.CCD
TEMP.CFG	01-04-29\10-41-10.CCD	TEMP.CFG	01-04-29\23-05-56.CCD
TEMP.CFG	01-04-29\11-48-50.CCD		

C.36 01-04-30

Configuration File	CCD File	Configuration File	CCD File
TEMP.CFG	01-04-30\00-13-37.CCD	TEMP.CFG	01-04-30\12-38-00.CCD
TEMP.CFG	01-04-30\01-21-17.CCD	TEMP.CFG	01-04-30\13-45-42.CCD
TEMP.CFG	01-04-30\02-28-58.CCD	TEMP.CFG	01-04-30\14-53-22.CCD
TEMP.CFG	01-04-30\03-36-39.CCD	TEMP.CFG	01-04-30\16-01-03.CCD
TEMP.CFG	01-04-30\04-44-20.CCD	TEMP.CFG	01-04-30\17-08-43.CCD
TEMP.CFG	01-04-30\05-51-59.CCD	TEMP.CFG	01-04-30\18-16-25.CCD
TEMP.CFG	01-04-30\06-59-39.CCD	TEMP.CFG	01-04-30\19-24-06.CCD
TEMP.CFG	01-04-30\08-07-20.CCD	TEMP.CFG	01-04-30\20-31-45.CCD
TEMP.CFG	01-04-30\09-15-01.CCD	TEMP.CFG	01-04-30\21-39-27.CCD
TEMP.CFG	01-04-30\10-22-40.CCD	TEMP.CFG	01-04-30\22-47-08.CCD
TEMP.CFG	01-04-30\11-30-21.CCD	TEMP.CFG	01-04-30\23-54-48.CCD

C.37 01-05-01

Configuration File	CCD File	Configuration File	CCD File
TEMP.CFG	01-05-01\01-02-28.CCD	TEMP.CFG	01-05-01\14-35-09.CCD
TEMP.CFG	01-05-01\02-10-26.CCD	TEMP.CFG	01-05-01\15-42-50.CCD
TEMP.CFG	01-05-01\03-18-06.CCD	TEMP.CFG	01-05-01\16-50-31.CCD
TEMP.CFG	01-05-01\04-25-46.CCD	TEMP.CFG	01-05-01\17-58-12.CCD
TEMP.CFG	01-05-01\05-33-27.CCD	TEMP.CFG	01-05-01\19-05-53.CCD
TEMP.CFG	01-05-01\06-41-07.CCD	TEMP.CFG	01-05-01\20-13-34.CCD
TEMP.CFG	01-05-01\07-48-47.CCD	TEMP.CFG	01-05-01\21-21-15.CCD
TEMP.CFG	01-05-01\08-56-27.CCD	TEMP.CFG	01-05-01\22-30-32.CCD
TEMP.CFG	01-05-01\10-04-07.CCD	ALI10.CFG	01-05-01\23-38-13.CCD
TEMP.CFG	01-05-01\11-11-48.CCD	TX15.CFG	01-05-01\23-45-24.CCD
TEMP.CFG	01-05-01\12-19-49.CCD	TY15.CFG	01-05-01\23-58-24.CCD
TEMP.CFG	01-05-01\13-27-29.CCD		

C.38 01-05-02

Configuration File	CCD File	Configuration File	CCD File
TZ15.CFG	01-05-02\00-11-24.CCD	TX15.CFG	01-05-02\01-03-26.CCD
TX15.CFG	01-05-02\00-24-25.CCD	TY15.CFG	01-05-02\01-16-25.CCD
TY15.CFG	01-05-02\00-37-25.CCD	TZ15.CFG	01-05-02\01-29-26.CCD
TZ15.CFG	01-05-02\00-50-25.CCD		

R O S E T T A		Document: RO-IGM-TR-0002
IGM Institut für Geophysik und Meteorologie Technische Universität Braunschweig		Issue: 2
		Revision: 2
		Date: October 10, 2001
		Page: 318

C.39 01-08-28

Configuration File	CCD File	Configuration File	CCD File
TX15.CFG	01-08-28\11-32-31.CCD	TEMP.CFG	01-08-28\17-52-32.CCD
TY15.CFG	01-08-28\11-45-32.CCD	TEMP.CFG	01-08-28\19-00-13.CCD
TZ15.CFG	01-08-28\11-58-33.CCD	TEMP.CFG	01-08-28\20-07-55.CCD
TEMP.CFG	01-08-28\12-14-04.CCD	TEMP.CFG	01-08-28\21-15-36.CCD
TEMP.CFG	01-08-28\13-21-46.CCD	TEMP.CFG	01-08-28\22-23-17.CCD
TEMP.CFG	01-08-28\14-29-27.CCD	TEMP.CFG	01-08-28\23-30-58.CCD
TEMP.CFG	01-08-28\15-37-08.CCD	ali10.CFG	01-08-28\11-25-10.CCD
TEMP.CFG	01-08-28\16-44-50.CCD		

C.40 01-08-29

Configuration File	CCD File	Configuration File	CCD File
TEMP.CFG	01-08-29\00-38-40.CCD	TEMP.CFG	01-08-29\13-03-14.CCD
TEMP.CFG	01-08-29\01-46-21.CCD	TEMP.CFG	01-08-29\14-10-55.CCD
TEMP.CFG	01-08-29\02-54-02.CCD	TEMP.CFG	01-08-29\15-18-36.CCD
TEMP.CFG	01-08-29\04-01-42.CCD	TEMP.CFG	01-08-29\16-26-17.CCD
TEMP.CFG	01-08-29\05-09-24.CCD	TEMP.CFG	01-08-29\17-34-27.CCD
TEMP.CFG	01-08-29\06-17-05.CCD	TEMP.CFG	01-08-29\18-42-08.CCD
TEMP.CFG	01-08-29\07-24-48.CCD	TEMP.CFG	01-08-29\19-49-50.CCD
TEMP.CFG	01-08-29\08-32-29.CCD	TEMP.CFG	01-08-29\20-57-31.CCD
TEMP.CFG	01-08-29\09-40-10.CCD	TEMP.CFG	01-08-29\22-05-12.CCD
TEMP.CFG	01-08-29\10-47-52.CCD	TEMP.CFG	01-08-29\23-12-54.CCD
TEMP.CFG	01-08-29\11-55-33.CCD		

C.41 01-08-30

Configuration File	CCD File	Configuration File	CCD File
TEMP.CFG	01-08-30\00-20-56.CCD	TEMP.CFG	01-08-30\13-01-26.CCD
TEMP.CFG	01-08-30\01-28-37.CCD	TEMP.CFG	01-08-30\14-09-22.CCD
TEMP.CFG	01-08-30\02-36-18.CCD	TEMP.CFG	01-08-30\15-17-04.CCD
TEMP.CFG	01-08-30\03-43-59.CCD	TEMP.CFG	01-08-30\16-24-44.CCD
TEMP.CFG	01-08-30\04-51-40.CCD	TEMP.CFG	01-08-30\17-32-25.CCD
TEMP.CFG	01-08-30\05-59-22.CCD	TEMP.CFG	01-08-30\18-40-07.CCD
TEMP.CFG	01-08-30\07-07-03.CCD	TEMP.CFG	01-08-30\19-47-48.CCD
TEMP.CFG	01-08-30\08-14-45.CCD	TEMP.CFG	01-08-30\20-55-28.CCD
TEMP.CFG	01-08-30\09-22-26.CCD	TEMP.CFG	01-08-30\22-03-10.CCD
TEMP.CFG	01-08-30\10-30-07.CCD	TEMP.CFG	01-08-30\23-10-50.CCD
TEMP.CFG	01-08-30\11-37-48.CCD		

C.42 01-08-31

Configuration File	CCD File	Configuration File	CCD File
TEMP.CFG	01-08-31\00-18-53.CCD	TEMP.CFG	01-08-31\12-44-09.CCD
TEMP.CFG	01-08-31\01-26-33.CCD	TEMP.CFG	01-08-31\13-52-07.CCD
TEMP.CFG	01-08-31\02-34-12.CCD	TEMP.CFG	01-08-31\14-59-47.CCD
TEMP.CFG	01-08-31\03-41-53.CCD	TEMP.CFG	01-08-31\16-07-27.CCD
TEMP.CFG	01-08-31\04-49-33.CCD	TEMP.CFG	01-08-31\17-15-08.CCD
TEMP.CFG	01-08-31\05-57-13.CCD	TEMP.CFG	01-08-31\18-22-47.CCD
TEMP.CFG	01-08-31\07-05-48.CCD	TEMP.CFG	01-08-31\19-30-28.CCD
TEMP.CFG	01-08-31\08-13-29.CCD	TEMP.CFG	01-08-31\20-38-08.CCD
TEMP.CFG	01-08-31\09-21-09.CCD	TEMP.CFG	01-08-31\21-45-49.CCD
TEMP.CFG	01-08-31\10-28-49.CCD	TEMP.CFG	01-08-31\22-53-29.CCD
TEMP.CFG	01-08-31\11-36-29.CCD		

C.43 01-09-01

Configuration File	CCD File	Configuration File	CCD File
TEMP.CFG	01-09-01\00-01-10.CCD	TEMP.CFG	01-09-01\12-25-35.CCD
TEMP.CFG	01-09-01\01-08-50.CCD	TEMP.CFG	01-09-01\13-33-16.CCD
TEMP.CFG	01-09-01\02-16-31.CCD	TEMP.CFG	01-09-01\14-40-56.CCD
TEMP.CFG	01-09-01\03-24-11.CCD	TEMP.CFG	01-09-01\15-48-37.CCD
TEMP.CFG	01-09-01\04-31-52.CCD	TEMP.CFG	01-09-01\16-56-17.CCD
TEMP.CFG	01-09-01\05-39-32.CCD	TEMP.CFG	01-09-01\18-03-58.CCD
TEMP.CFG	01-09-01\06-47-12.CCD	TEMP.CFG	01-09-01\19-11-38.CCD
TEMP.CFG	01-09-01\07-54-52.CCD	TEMP.CFG	01-09-01\20-19-19.CCD
TEMP.CFG	01-09-01\09-02-33.CCD	TEMP.CFG	01-09-01\21-26-59.CCD
TEMP.CFG	01-09-01\10-10-14.CCD	TEMP.CFG	01-09-01\22-34-40.CCD
TEMP.CFG	01-09-01\11-17-54.CCD	TEMP.CFG	01-09-01\23-42-21.CCD

C.44 01-09-02

Configuration File	CCD File	Configuration File	CCD File
TEMP.CFG	01-09-02\00-50-02.CCD	TEMP.CFG	01-09-02\06-28-52.CCD
TEMP.CFG	01-09-02\01-58-11.CCD	TEMP.CFG	01-09-02\07-36-34.CCD
TEMP.CFG	01-09-02\03-05-50.CCD	TEMP.CFG	01-09-02\08-44-13.CCD
TEMP.CFG	01-09-02\04-13-30.CCD	TEMP.CFG	01-09-02\09-51-54.CCD
TEMP.CFG	01-09-02\05-21-11.CCD	TEMP.CFG	01-09-02\10-59-34.CCD

R O S E T T A		Document: RO-IGM-TR-0002
IGM Institut für Geophysik und Meteorologie Technische Universität Braunschweig		Issue: 2
		Revision: 2
		Date: October 10, 2001
		Page: 320

C.45 01-09-03

Configuration File	CCD File	Configuration File	CCD File
TEMP.CFG	01-09-03\01-39-34.CCD	TEMP.CFG	01-09-03\05-02-36.CCD
TEMP.CFG	01-09-03\02-47-15.CCD	TEMP.CFG	01-09-03\06-10-17.CCD
TEMP.CFG	01-09-03\03-54-56.CCD	TEMP.CFG	01-09-03\00-31-53.CCD

C.46 01-09-06

Configuration File	CCD File	Configuration File	CCD File
ali10.CFG	01-09-06\12-07-17.CCD	TEMP.CFG	01-09-06\16-17-57.CCD
TX15.CFG	01-09-06\12-14-27.CCD	TEMP.CFG	01-09-06\17-25-39.CCD
TY15.CFG	01-09-06\12-27-28.CCD	TEMP.CFG	01-09-06\18-33-21.CCD
TZ15.CFG	01-09-06\12-40-29.CCD	TEMP.CFG	01-09-06\19-41-02.CCD
TEMP.CFG	01-09-06\12-54-54.CCD	TEMP.CFG	01-09-06\20-48-41.CCD
TEMP.CFG	01-09-06\14-02-36.CCD	TEMP.CFG	01-09-06\21-56-22.CCD
TEMP.CFG	01-09-06\15-10-17.CCD	TEMP.CFG	01-09-06\23-04-03.CCD

C.47 01-09-07

Configuration File	CCD File	Configuration File	CCD File
TEMP.CFG	01-09-07\00-11-43.CCD	TEMP.CFG	01-09-07\12-37-25.CCD
TEMP.CFG	01-09-07\01-19-24.CCD	TEMP.CFG	01-09-07\13-45-05.CCD
TEMP.CFG	01-09-07\02-27-06.CCD	TEMP.CFG	01-09-07\14-52-46.CCD
TEMP.CFG	01-09-07\03-34-46.CCD	TEMP.CFG	01-09-07\16-00-27.CCD
TEMP.CFG	01-09-07\04-42-26.CCD	TEMP.CFG	01-09-07\17-08-10.CCD
TEMP.CFG	01-09-07\05-50-07.CCD	TEMP.CFG	01-09-07\18-15-50.CCD
TEMP.CFG	01-09-07\06-58-11.CCD	TEMP.CFG	01-09-07\19-23-30.CCD
TEMP.CFG	01-09-07\08-05-52.CCD	TEMP.CFG	01-09-07\20-31-10.CCD
TEMP.CFG	01-09-07\09-14-24.CCD	TEMP.CFG	01-09-07\21-38-51.CCD
TEMP.CFG	01-09-07\10-22-04.CCD	TEMP.CFG	01-09-07\22-46-32.CCD
TEMP.CFG	01-09-07\11-29-45.CCD	TEMP.CFG	01-09-07\23-54-13.CCD

C.48 01-09-08

Configuration File	CCD File	Configuration File	CCD File
TEMP.CFG	01-09-08\02-09-34.CCD	TEMP.CFG	01-09-08\14-34-00.CCD
TEMP.CFG	01-09-08\03-17-14.CCD	TEMP.CFG	01-09-08\15-41-41.CCD
TEMP.CFG	01-09-08\04-24-53.CCD	TEMP.CFG	01-09-08\16-49-22.CCD
TEMP.CFG	01-09-08\05-32-34.CCD	TEMP.CFG	01-09-08\17-57-02.CCD
TEMP.CFG	01-09-08\06-40-14.CCD	TEMP.CFG	01-09-08\19-04-42.CCD
TEMP.CFG	01-09-08\07-47-55.CCD	TEMP.CFG	01-09-08\20-12-21.CCD
TEMP.CFG	01-09-08\08-55-35.CCD	TEMP.CFG	01-09-08\21-20-01.CCD
TEMP.CFG	01-09-08\10-03-16.CCD	TEMP.CFG	01-09-08\22-27-42.CCD
TEMP.CFG	01-09-08\11-10-56.CCD	TEMP.CFG	01-09-08\23-35-22.CCD
TEMP.CFG	01-09-08\12-18-39.CCD	TEMP.CFG	01-09-08\01-01-54.CCD
TEMP.CFG	01-09-08\13-26-19.CCD		

C.49 01-09-09

Configuration File	CCD File	Configuration File	CCD File
TEMP.CFG	01-09-09\00-43-03.CCD	TEMP.CFG	01-09-09\13-09-28.CCD
TEMP.CFG	01-09-09\01-50-44.CCD	TEMP.CFG	01-09-09\14-17-29.CCD
TEMP.CFG	01-09-09\02-58-25.CCD	TEMP.CFG	01-09-09\15-25-10.CCD
TEMP.CFG	01-09-09\04-06-06.CCD	TEMP.CFG	01-09-09\16-32-50.CCD
TEMP.CFG	01-09-09\05-14-07.CCD	TEMP.CFG	01-09-09\17-40-31.CCD
TEMP.CFG	01-09-09\06-21-46.CCD	TEMP.CFG	01-09-09\18-48-12.CCD
TEMP.CFG	01-09-09\07-29-27.CCD	TEMP.CFG	01-09-09\19-55-53.CCD
TEMP.CFG	01-09-09\08-38-47.CCD	TEMP.CFG	01-09-09\21-03-33.CCD
TEMP.CFG	01-09-09\09-46-27.CCD	TEMP.CFG	01-09-09\22-11-14.CCD
TEMP.CFG	01-09-09\10-54-08.CCD	TEMP.CFG	01-09-09\23-18-54.CCD
TEMP.CFG	01-09-09\12-01-48.CCD		

C.50 01-09-10

Configuration File	CCD File	Configuration File	CCD File
TEMP.CFG	01-09-10\15-10-43.CCD	TEMP.CFG	01-09-10\02-41-54.CCD
TEMP.CFG	01-09-10\16-18-24.CCD	TEMP.CFG	01-09-10\03-49-34.CCD
TEMP.CFG	01-09-10\17-27-04.CCD	TEMP.CFG	01-09-10\04-57-15.CCD
TEMP.CFG	01-09-10\18-34-43.CCD	TEMP.CFG	01-09-10\06-04-54.CCD
TEMP.CFG	01-09-10\19-42-24.CCD	TEMP.CFG	01-09-10\07-12-35.CCD
TEMP.CFG	01-09-10\20-50-04.CCD	TEMP.CFG	01-09-10\08-20-15.CCD
TEMP.CFG	01-09-10\21-57-44.CCD	TEMP.CFG	01-09-10\09-27-55.CCD
TEMP.CFG	01-09-10\23-05-25.CCD	TEMP.CFG	01-09-10\10-35-36.CCD
TEMP.CFG	01-09-10\00-26-35.CCD	TEMP.CFG	01-09-10\11-43-16.CCD
TEMP.CFG	01-09-10\01-34-15.CCD	TEMP.CFG	01-09-10\12-50-56.CCD

R O S E T T A		Document: RO-IGM-TR-0002
IGM Institut für Geophysik und Meteorologie Technische Universität Braunschweig		Issue: 2
		Revision: 2
		Date: October 10, 2001
		Page: 322

C.51 01-09-11

Configuration File	CCD File	Configuration File	CCD File
TEMP.CFG	01-09-11\00-13-06.CCD	TEMP.CFG	01-09-11\12-38-13.CCD
TEMP.CFG	01-09-11\01-20-47.CCD	TEMP.CFG	01-09-11\13-45-52.CCD
TEMP.CFG	01-09-11\02-28-28.CCD	TEMP.CFG	01-09-11\14-53-33.CCD
TEMP.CFG	01-09-11\03-36-08.CCD	TEMP.CFG	01-09-11\16-01-13.CCD
TEMP.CFG	01-09-11\04-43-49.CCD	TEMP.CFG	01-09-11\17-08-54.CCD
TEMP.CFG	01-09-11\05-51-59.CCD	TEMP.CFG	01-09-11\18-16-35.CCD
TEMP.CFG	01-09-11\06-59-40.CCD	TEMP.CFG	01-09-11\19-24-16.CCD
TEMP.CFG	01-09-11\08-07-33.CCD	TEMP.CFG	01-09-11\20-31-57.CCD
TEMP.CFG	01-09-11\09-15-12.CCD	TEMP.CFG	01-09-11\21-39-38.CCD
TEMP.CFG	01-09-11\10-22-53.CCD	TEMP.CFG	01-09-11\22-47-17.CCD
TEMP.CFG	01-09-11\11-30-33.CCD	TEMP.CFG	01-09-11\23-54-58.CCD

C.52 01-09-12

Configuration File	CCD File	Configuration File	CCD File
TEMP.CFG	01-09-12\01-02-38.CCD	TEMP.CFG	01-09-12\13-27-23.CCD
TEMP.CFG	01-09-12\02-10-18.CCD	TEMP.CFG	01-09-12\14-35-29.CCD
TEMP.CFG	01-09-12\03-17-59.CCD	TEMP.CFG	01-09-12\15-43-38.CCD
TEMP.CFG	01-09-12\04-25-39.CCD	TEMP.CFG	01-09-12\16-51-18.CCD
TEMP.CFG	01-09-12\05-33-19.CCD	TEMP.CFG	01-09-12\17-58-58.CCD
TEMP.CFG	01-09-12\06-40-59.CCD	TEMP.CFG	01-09-12\19-06-39.CCD
TEMP.CFG	01-09-12\07-49-00.CCD	TEMP.CFG	01-09-12\20-14-19.CCD
TEMP.CFG	01-09-12\08-56-40.CCD	TEMP.CFG	01-09-12\21-21-59.CCD
TEMP.CFG	01-09-12\10-04-21.CCD	TEMP.CFG	01-09-12\22-29-40.CCD
TEMP.CFG	01-09-12\11-12-02.CCD	TEMP.CFG	01-09-12\23-37-21.CCD
TEMP.CFG	01-09-12\12-19-42.CCD		

C.53 01-09-13

Configuration File	CCD File	Configuration File	CCD File
TEMP.CFG	01-09-13\00-45-03.CCD	TEMP.CFG	01-09-13\04-08-04.CCD
TEMP.CFG	01-09-13\01-52-44.CCD	TEMP.CFG	01-09-13\05-15-45.CCD
TEMP.CFG	01-09-13\03-00-24.CCD	TEMP.CFG	01-09-13\06-23-26.CCD

D FGM Sensor Alignment Tables

The following tables 9 shows the alignment data measured with all the ALI10.CFG files during the whole calibration session. The data are listed in chronological order for both sensors in parallel. See the following table which lists the magnetometer answer on a positive field applied on the coil system axis X_c , Y_c , and Z_c .

*.CCD File	FGM Data	FGM-IB			FGM-OB		
		X_c	Y_c	Z_c	X_c	Y_c	Z_c
01-03-19\15-01-03.CCD	ALI_01	-Y _m	+X _m	+Z _m	-Y _m	+X _m	+Z _m
01-03-19\15-29-16.CCD	ALI_02	+Y _m	-X _m	+Z _m	+Y _m	-X _m	+Z _m
01-03-19\15-53-19.CCD	ALI_03	-Y _m	-X _m	-Z _m	-Y _m	-X _m	-Z _m
01-03-19\16-23-48.CCD	ALI_04	-Y _m	+X _m	+Z _m	-Y _m	+X _m	+Z _m
01-03-21\12-58-42.CCD	ALI_05	-Y _m	+X _m	+Z _m	-Y _m	+X _m	+Z _m
01-03-22\12-44-38.CCD	ALI_06	-Y _m	+X _m	+Z _m	-Y _m	+X _m	+Z _m
01-03-23\12-21-23.CCD	ALI_07	-Y _m	+X _m	+Z _m	-Y _m	+X _m	+Z _m
01-03-23\13-58-41.CCD	ALI_08	-Y _m	+X _m	+Z _m	-Y _m	+X _m	+Z _m
01-03-28\08-56-45.CCD	ALI_09	-Y _m	+X _m	+Z _m	-Y _m	+X _m	+Z _m
01-03-28\09-51-44.CCD	ALI_10	-Y _m	+X _m	+Z _m	-Y _m	+X _m	+Z _m
01-04-05\09-34-37.CCD	ALI_11	-Y _m	+X _m	+Z _m	-Y _m	+X _m	+Z _m
01-04-05\09-51-50.CCD	ALI_12	+Y _m	-X _m	+Z _m	+Y _m	-X _m	+Z _m
01-04-05\10-15-05.CCD	ALI_13	-Y _m	-X _m	-Z _m	-Y _m	-X _m	-Z _m
01-04-05\10-45-49.CCD	ALI_14		diagonal			diagonal	
01-04-05\12-59-59.CCD	ALI_15	-Y _m	+X _m	+Z _m	-Y _m	+X _m	+Z _m
01-04-06\07-18-23.CCD	ALI_16	-Y _m	+X _m	+Z _m	-Y _m	+X _m	+Z _m
01-04-20\08-53-39.CCD	ALI_17		diagonal			diagonal	
01-04-20\12-00-24.CCD	ALI_18	-Y _m	+X _m	+Z _m	-Y _m	+X _m	+Z _m
01-04-21\11-21-57.CCD	ALI_19	-Y _m	+X _m	+Z _m	-Y _m	+X _m	+Z _m
01-04-23\07-00-01.CCD	ALI_20		diagonal			diagonal	
01-04-23\08-53-30.CCD	ALI_21	-Y _m	+X _m	+Z _m	-Y _m	+X _m	+Z _m
01-04-23\09-10-36.CCD	ALI_22	+Y _m	-X _m	+Z _m	+Y _m	-X _m	+Z _m
01-04-23\09-34-59.CCD	ALI_23	+Y _m	+X _m	-Z _m	+Y _m	+X _m	-Z _m
01-04-23\10-25-59.CCD	ALI_24	-Y _m	+X _m	+Z _m	-Y _m	+X _m	+Z _m
01-04-24\11-22-15.CCD	ALI_25	-Y _m	+X _m	+Z _m	-Y _m	+X _m	+Z _m
01-04-25\11-20-48.CCD	ALI_26		diagonal			diagonal	
01-04-25\13-19-54.CCD	ALI_27	-Y _m	+X _m	+Z _m	-Y _m	+X _m	+Z _m
01-04-25\13-38-17.CCD	ALI_28	+Y _m	-X _m	+Z _m	+Y _m	-X _m	+Z _m
01-04-25\14-01-34.CCD	ALI_29	-Y _m	-X _m	-Z _m	-Y _m	-X _m	-Z _m
01-04-25\14-38-48.CCD	ALI_30		diagonal			diagonal	
01-04-26\09-57-42.CCD	ALI_31	-Y _m	+X _m	+Z _m	-Y _m	+X _m	+Z _m
01-04-26\11-26-34.CCD	ALI_32	-Y _m	+X _m	+Z _m	-Y _m	+X _m	+Z _m
01-05-01\23-38-13.CCD	ALI_33	-Y _m	+X _m	+Z _m	-Y _m	+X _m	+Z _m
01-08-28\11-25-10.CCD	ALI_35	-Y _m	+X _m	+Z _m	-Y _m	+X _m	+Z _m
01-09-06\12-07-17.CCD	ALI_36	-Y _m	+X _m	+Z _m	-Y _m	+X _m	+Z _m

Table 9: Alignment 1: Results of all the FGM alignment measurements during the whole calibration session.

As a new feature for this calibration session the alignment is computed directly from the extracted data (ALI_xx). In former sessions this work was done manually by looking on

R O S E T T A		Document: RO-IGM-TR-0002
		Issue: 2
		Revision: 2
IGM	Institut für Geophysik und Meteorologie	Date: October 10, 2001
	Technische Universität Braunschweig	Page: 324

plots and writing down the alignments. Special for the analysis of the ROSETTA calibration a new version of the alignment tool, working with two magnetometers simultaneous, was developed. This tool is named `align_2.pas`.

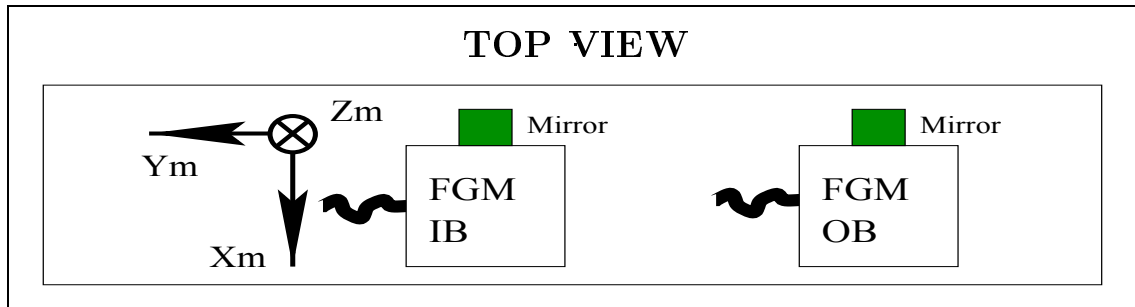

Figure 221: The FGM sensors FGM-OB and FGM-IB seen from the top with their coordinate system mounted on the aluminium support.

E Temperature Measurements

E.1 Sensor Temperatures

The sensor temperatures are measured using standard PT1000 elements inside the sensors. Table E.1 gives a part of the manufactures provided nominal function used for the measurements here. For the plots in this document polynomial approximations of order 3 for the functions $T(U)$ is used.

$$T(U) = a_0 + a_1U + a_2U^2 + a_3U^3 \quad (1)$$

with

$$a_0 = -368.61072$$

$$a_1 = 458.49304$$

$$a_2 = -356.02890$$

$$a_3 = 180.00644$$

T [°C]	R(T) [Ω]	U(T) [V]	T [°C]	R(T) [Ω]	U(T) [V]
-150.000	423.219	0.743420	10.0000	1039.14	1.27399
-140.000	461.402	0.789310	20.0000	1078.40	1.29715
-130.000	499.567	0.832850	30.0000	1117.77	1.31951
-120.000	537.730	0.874230	40.0000	1157.26	1.34112
-110.000	575.906	0.913610	50.0000	1196.86	1.36201
-100.000	614.108	0.951160	60.0000	1236.58	1.38222
-90.0000	652.351	0.987000	70.0000	1276.41	1.40178
-80.0000	690.646	1.02128	80.0000	1316.36	1.42072
-70.0000	729.005	1.05408	90.0000	1356.43	1.43907
-60.0000	767.436	1.08552	100.000	1396.60	1.45686
-50.0000	805.950	1.11569	110.000	1436.90	1.47411
-40.0000	844.555	1.14466	120.000	1477.31	1.49084
-30.0000	883.256	1.17251	130.000	1517.84	1.50708
-20.0000	922.061	1.19931	140.000	1558.48	1.52286
-10.0000	960.974	1.22512	150.000	1599.24	1.53818
0.000000	1000.00	1.25000			

Table 10: Calibration data for the sensor PT1000 elements, nominal data provided by the manufacturer.

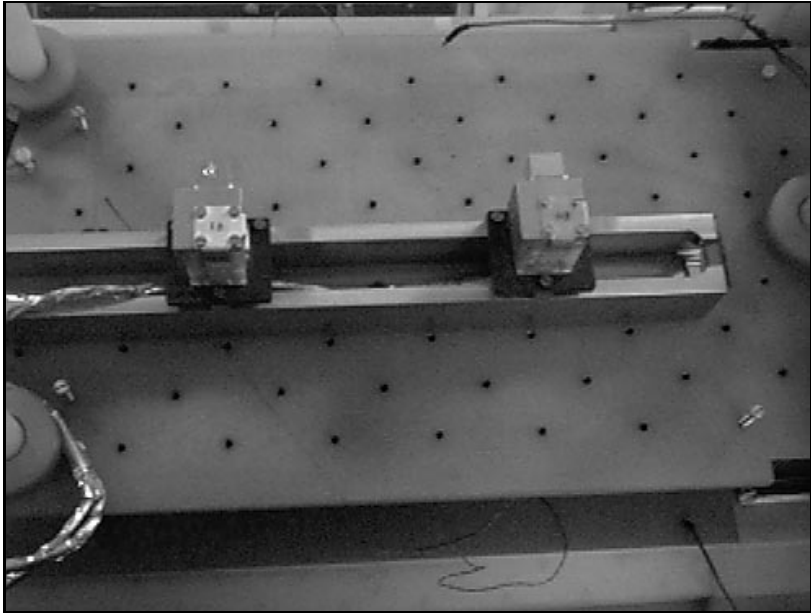

Figure 222: I010322A

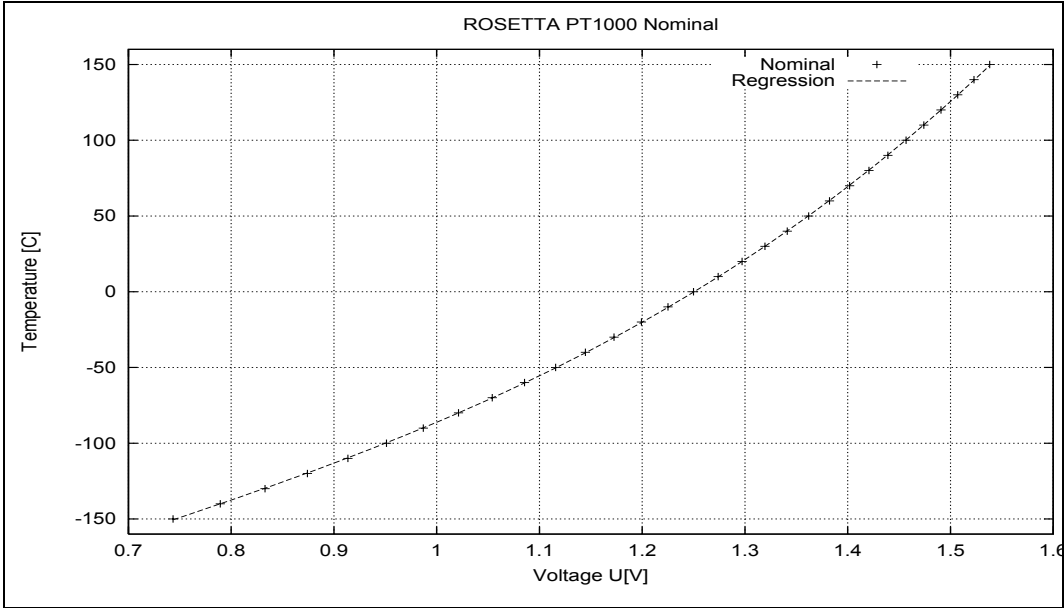

Figure 223: Nominal function and regression for a standard PT1000 thermistor element.

E.2 Thermal Test Box Temperatures

Figure 234 shows a picture of the Thermal Test Box with the installed sensors. The heater foils and the basin are not just installed to show the orientation of the sensors. The following table gives again the TEMESYS-B channel with respect to the position of the sensor inside the Thermal Test Box. See also the draft in figure 224 on page 327.

Sensor	Position
T ₅₇	under FGM-OB sensor
T ₅₉	under FGM-IB sensor
T ₅₆	mounting plate, upper side, north west corner
T ₅₈	mounting plate, upper side, south west corner
T ₂₉	mounting plate, upper side, center
T ₆₀	ground plate, north middle
T ₆₁	mounting plate, lower side, center
T ₆₂	ground plate, south west
T ₆₃	ground plate, south east

Table 11: The TEMESYS-B sensors in the Thermal Test Box.

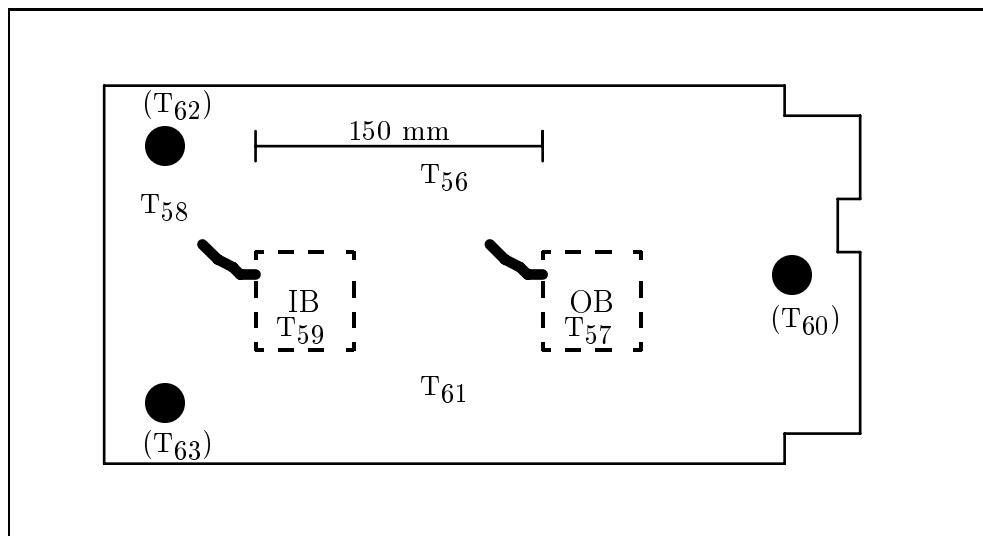

Figure 224: The temperature sensors at the Thermal Test Box mounting plate. The draft shows the top view. Sensors in brackets are mounted near the Thermal Test Box ground plate, not on the mounting plate.

E.3 Temperature Calibration Cycle 1, March 2001, DPU: FM, Sensors: FM

The following figure 225 shows an overview of the temperature cycle performed from March 23rd to March 29th. The arbitrary step function starting early on March 25th is the nominal goal temperature. Due to an error on the Thermal Test Box Power Supply no heating occurs. Later on the 25th the heating is restarted manually and the system performs normally. The instrument temperatures can be found in detail on the overview plots for the specific day.

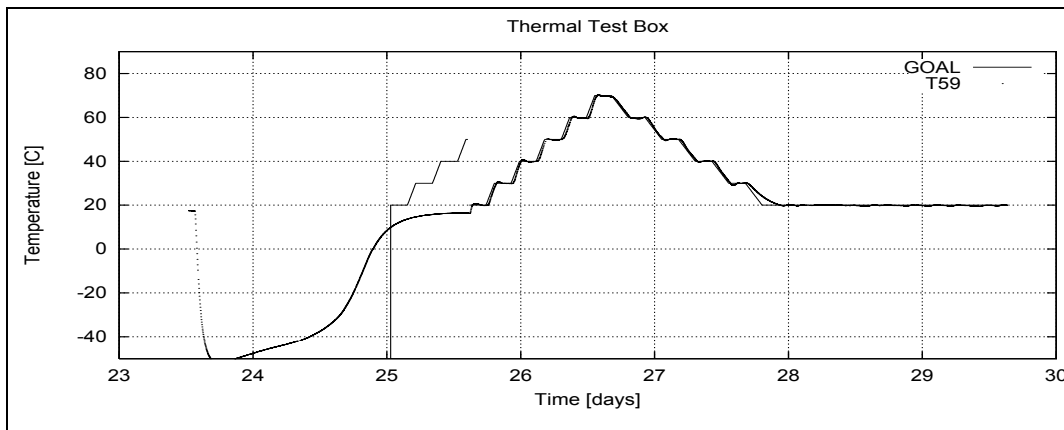

Figure 225: The first Temperature Calibration Cycle, March 23rd to March 29th.

E.4 Temperature Calibration Cycle 2, April 2001,DPU: FS, Sensors: FS

The second run is without any doubts. In the plot the days are numbered ongoing starting at the 26th. Therefore, 31 is May 1st.

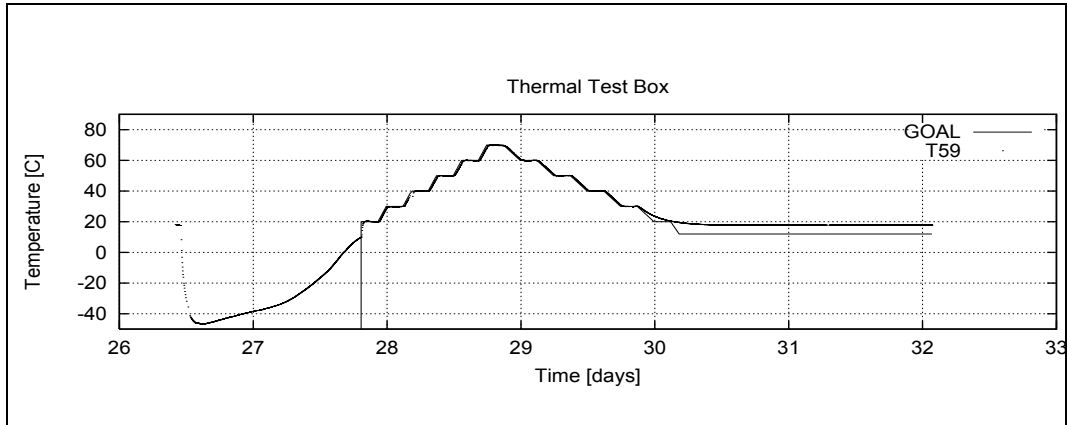

Figure 226: The first Temperature Calibration Cycle, April 26th to May 2nd.

E.5 Temperature Calibration Cycle 3, August 2001,DPU: FS, Sensors: FS

Caused by some trouble analyzing the Temperature Calibration Cycles they are redone starting on the 28th of August.

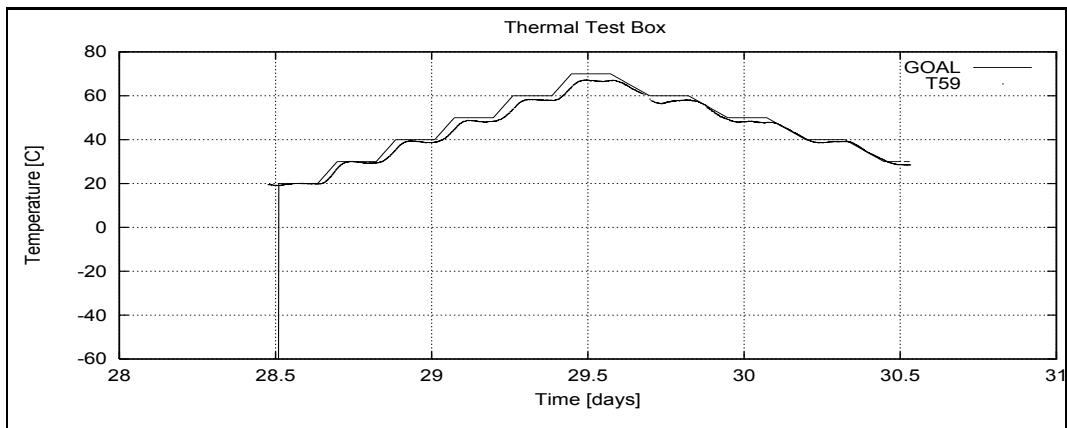

Figure 227: The third Temperature Calibration Cycle, heating cycle from August 28th to 30th.

E.6 Temperature Calibration Cycle 4, August and September 2001, DPU: FS, Sensors: FS

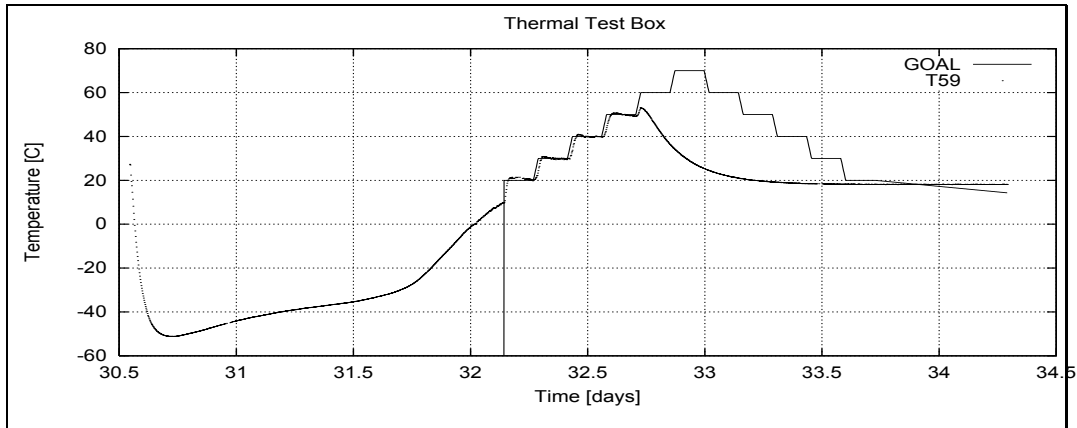

Figure 228: The fourth Temperature Calibration Cycle, cooling cycle from August 30th to September 1st and heating cycle from September 1st to 3rd.

It is obvious, that the heating was not completed. In the afternoon of September 1st at 17:20 the heating stopped due melting of the main fuse of the temperature control electronics. Most likely the temperature profile was chosen to steep. Therefore, the required heater power was to large.

As the achieved temperature was already about 50°C it was decided to waive an other T-cycle.

E.7 Temperature Calibration Cycle 5, September 2001, DPU: FS, Sensors: FM

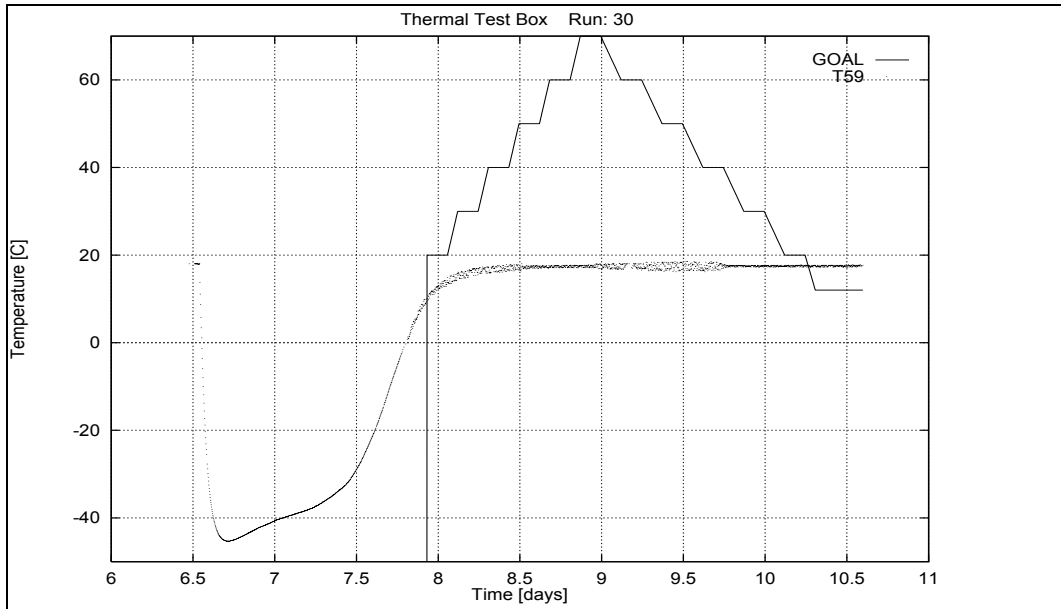

Figure 229: The fifth Temperature Calibration Cycle. Cooling from September 6th to September 10th.

After the cooling cycle the system did not start the heating cycle due to a loose contact at the heating foils. Therefore, the box was opened, the contact was fixed and the heating started in a sixth cycle.

E.8 Temperature Calibration Cycle 6, September 2001, DPU: FS, Sensors: FM

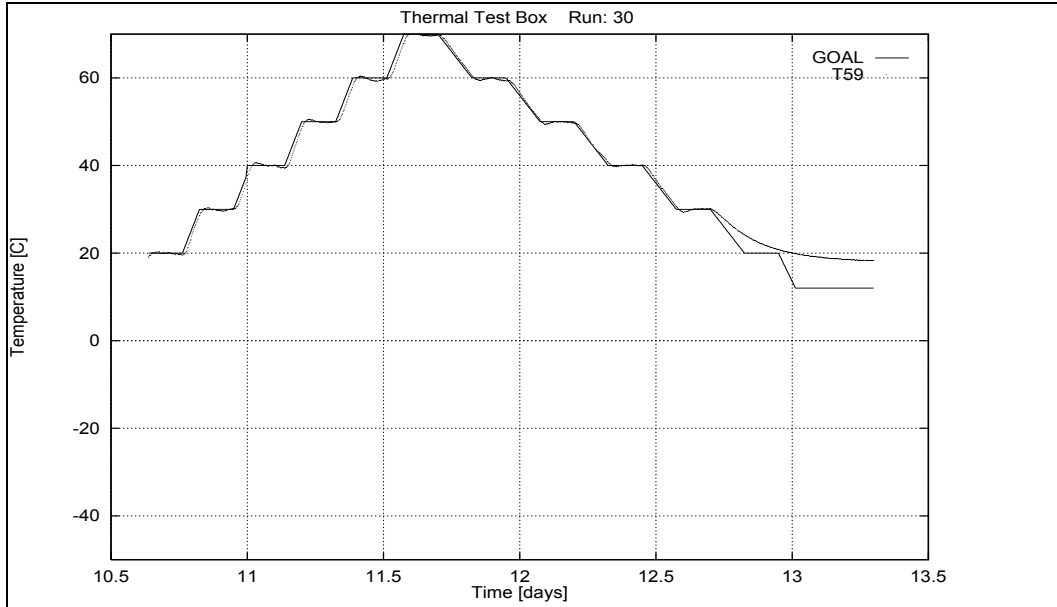

Figure 230: The sixth Temperature Calibration Cycle. Heating from September 10th to September 13th.

R O S E T T A	Document: RO-IGM-TR-0002
IGM Institut für Geophysik und Meteorologie Technische Universität Braunschweig	Issue: 2
	Revision: 2
	Date: October 10, 2001
	Page: 333

F Images of the ROSETTA Calibration

In the following you will find an album of all the fotos taken during the calibration session. Some of them are also used in the previous parts of the document, all others can be found here.

The following listing provides a short description to all the pictures.

```

----- ROSETTA -----
I010321A    FM-OB(north) optical aligned at CoC, south west view
I010322A    FM-IB(south) optical aligned at CoC, top east view
I010322B    FM-IB(south) optical aligned at CoC, south west view

I010323A    FM-OB(north) and FM-IB(south) in Temperature configuration
             top east view
I010323B    FM-OB(north) and FM-IB(south) in Temperature configuration
             south view

I010405A    FM-OB(north) at CoC, Offset position 1, normal, south west view
I010405B    FM-IB(south) at CoC, Offset position 2, normal, south west view
I010405C    FM-OB(south) at CoC, Offset position 3, turned, south west view
I010405D    FM-IB(north) at CoC, Offset position 4, turned, south west view
I010405E    FM-OB(north) at CoC, Offset position 5, turned, west view
I010405F    FM-IB(south) at CoC, Offset position 6, turned, west view
I010405G    FM-OB(down) and FM-IB(up) diagonal at CoC for frequency measurements
             south west view

I010405H    FM-OB(north) optical aligned at CoC, south west view

I010406A    FM-IB(south) optical aligned at CoC, west view

I010420A    FM-OB(up,2) and FM-IB(down,4) diagonal at CoC for frequency measurements
             south west view, sensor on Gradiometer mounting plate
             (Grad sensors at first and third position)

I010420B    FS-IB(south) optical aligned at CoC, south west view

I010421A    FS-OB(north) optical aligned at CoC, south west view

I010423A    FM-OB(down) and FM-IB(up) diagonal at CoC for frequency measurements
             south west view
I010423B    FS-OB(north) at CoC, Offset position 1, normal, south west view
I010423C    FM-OB(south) at CoC, Offset position 3, turned, south west view
I010423D    FM-OB(south) at CoC, Offset position 5, turned, west view

I010423E    FM-DPU, top view
I010423F    FS-IB(south) optical aligned at CoC, west view
I010424A    FS-DPU, Top view
I010424B    FS-OB(north) optical aligned at CoC, west view
-----

```

R O S E T T A		Document: RO-IGM-TR-0002
		Issue: 2
		Revision: 2
IGM	Institut für Geophysik und Meteorologie Technische Universität Braunschweig	Date: October 10, 2001
		Page: 334

----- ROSETTA -----

I010425A FM-OB(down) and FM-IB(up) diagonal at CoC for frequency measurements
south west view

I010425B FS-OB(north) at CoC, Offset position 1, normal, south west view

I010425C FS-IB(south) at CoC, Offset position 2, normal, south west view

I010425D FS-OB(south) at CoC, Offset position 3, turned, south west view

I010425E FS-IB(north) at CoC, Offset position 4, turned, south west view

I010425F FS-OB(north) at CoC, Offset position 5, turned, west view

I010425G FS-IB(south) at CoC, Offset position 6, turned, west view

I010425H FM-OB(up,2) and FM-IB(down,4) diagonal at CoC for frequency measurements
south west view, sensor on Gradiometer mounting plate
(Grad sensors at first and third position)

I010426A FM-OB(north) and FM-IB(south) in Temperature configuration
west view

I010426B FM-OB(north) and FM-IB(south) in Temperature configuration
south view

I010828A FS-IB (south) and FS-OB (north) in T-Box for temperature cycle

I010828B OVH at CoC (south west down to north east up) for residual field
check

I010913A Power supply and interface board (DPU-CLUSTERM) in Haouse 2 anteroom

I010913B FM-IB (south) and FM-OB (north) in T-Box for temperature cycle

F.1 Album

F.1.1 Images 01-03-21

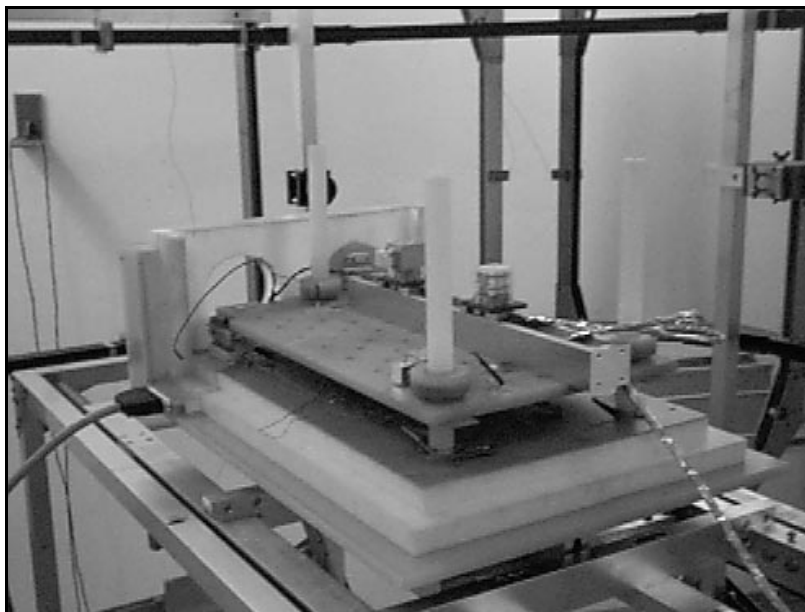

Figure 231: I010321A

F.1.2 Images 01-03-22

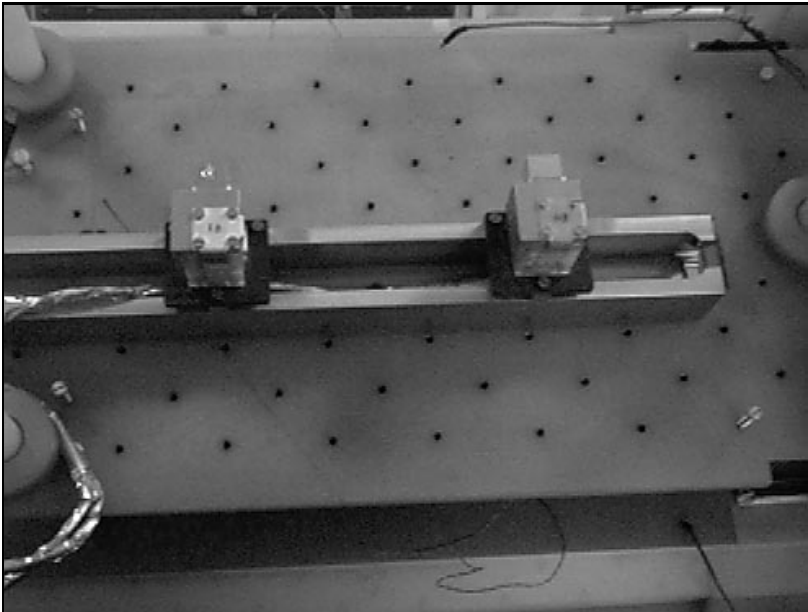

Figure 232: I010322A

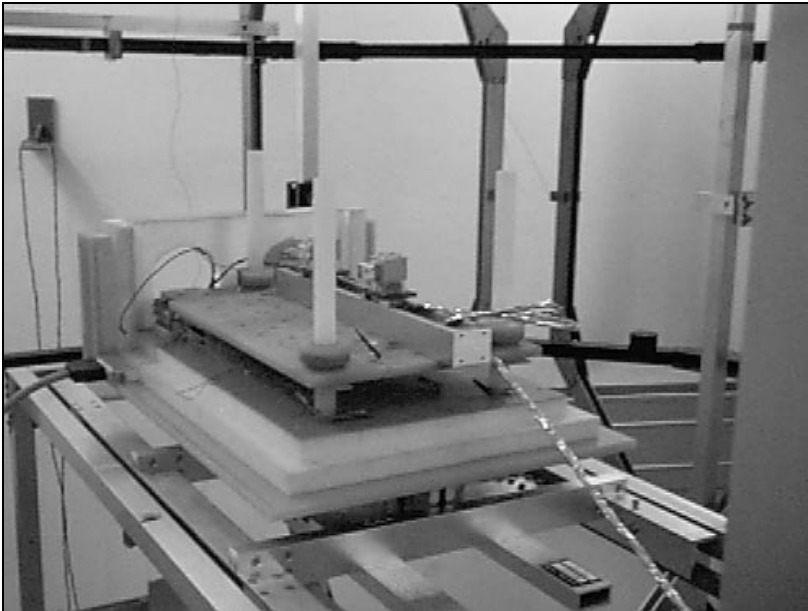

Figure 233: I010322B

F.1.3 Images 01-03-23

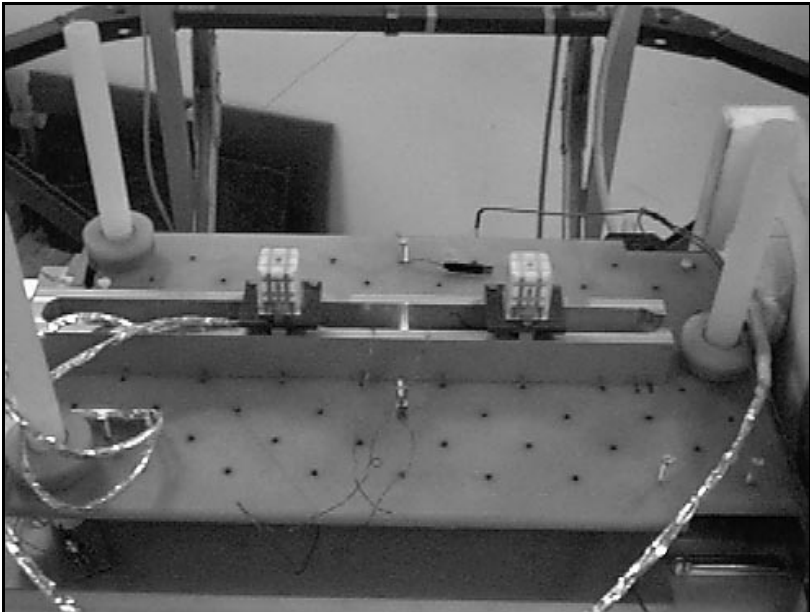

Figure 234: I010323A

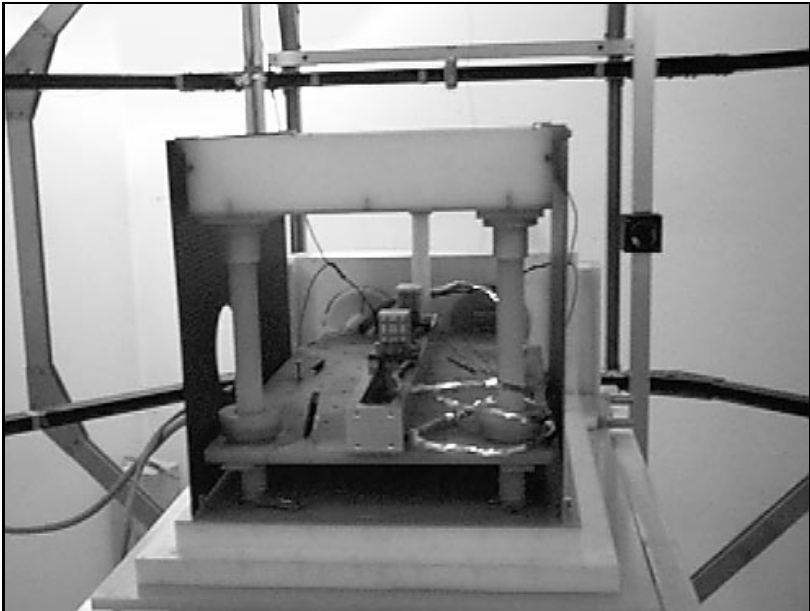

Figure 235: I010323B

F.1.4 Images 01-04-05

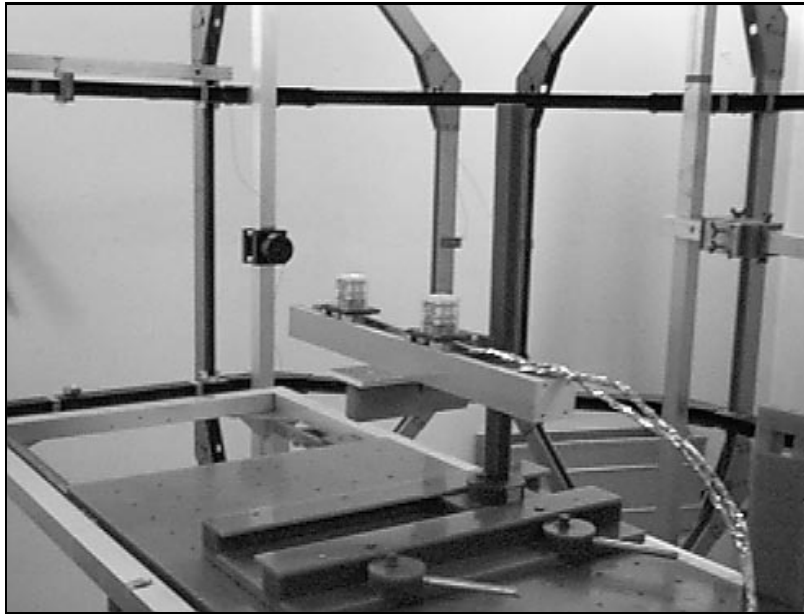

Figure 236: I010405A

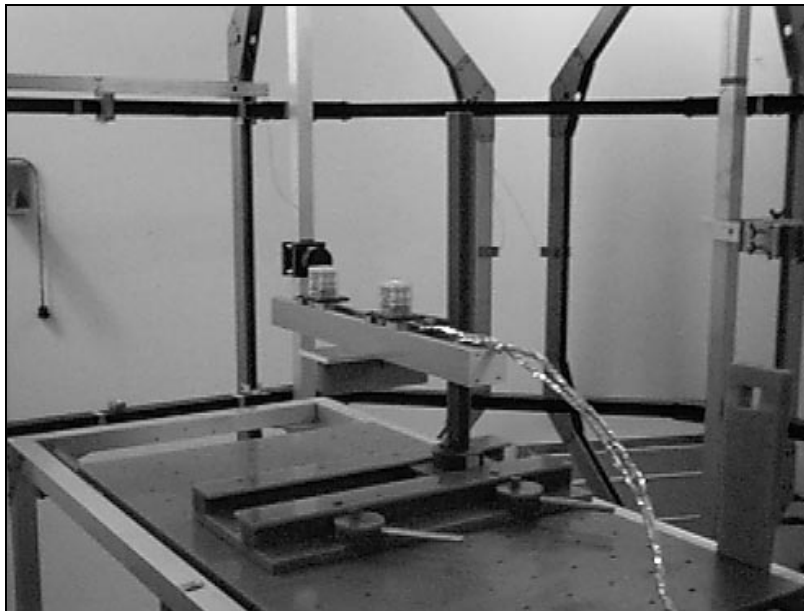

Figure 237: I010405B

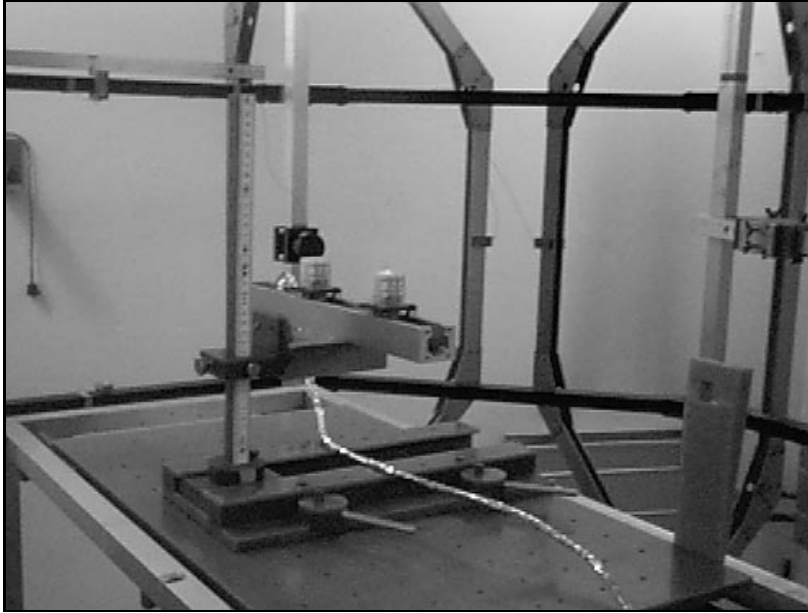

Figure 238: I010405C



Figure 239: I010405D

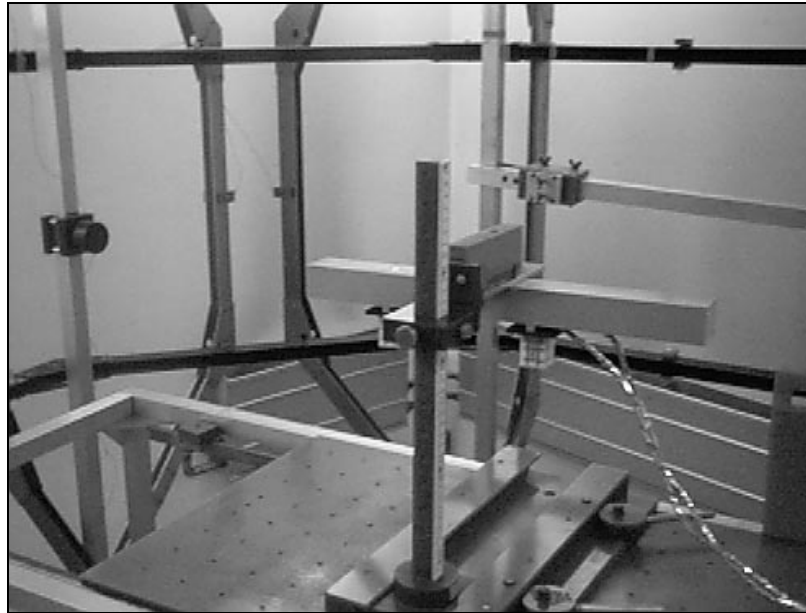

Figure 240: I010405E



Figure 241: I010405F

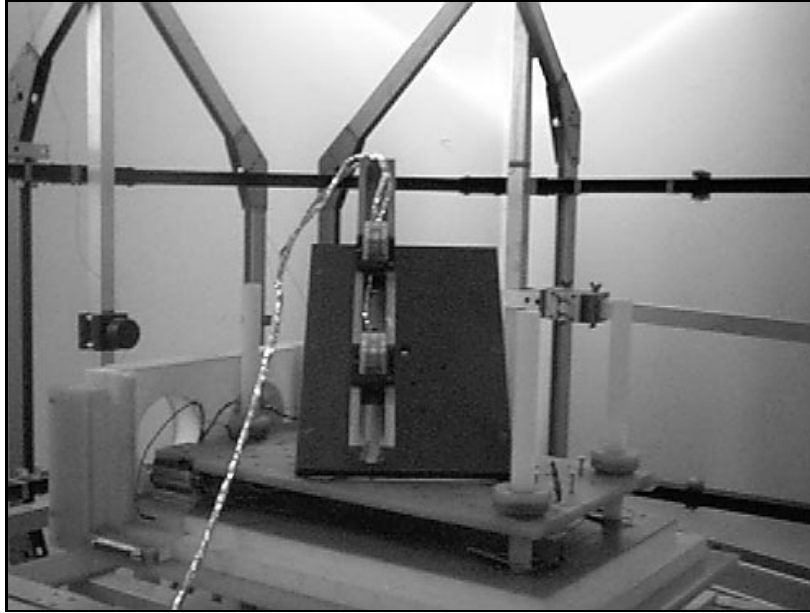

Figure 242: I010405G

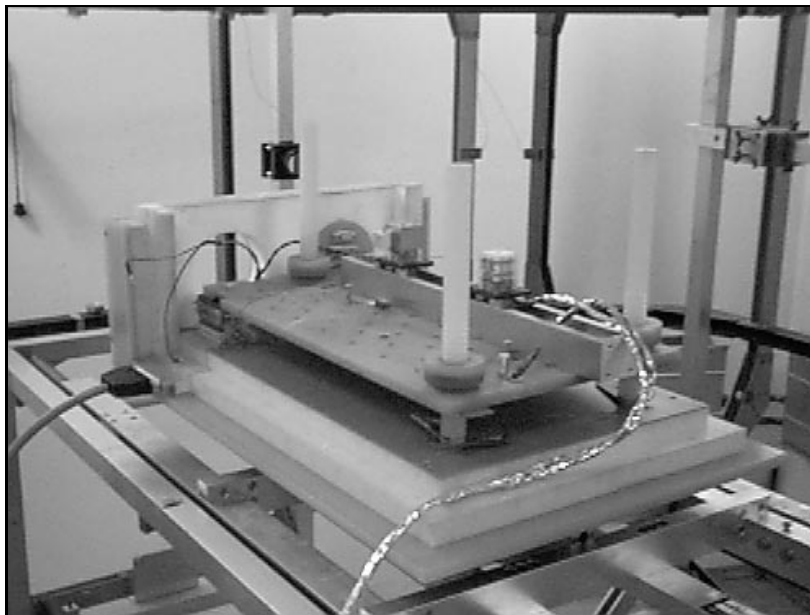

Figure 243: I010405H

F.1.5 Images 01-04-06

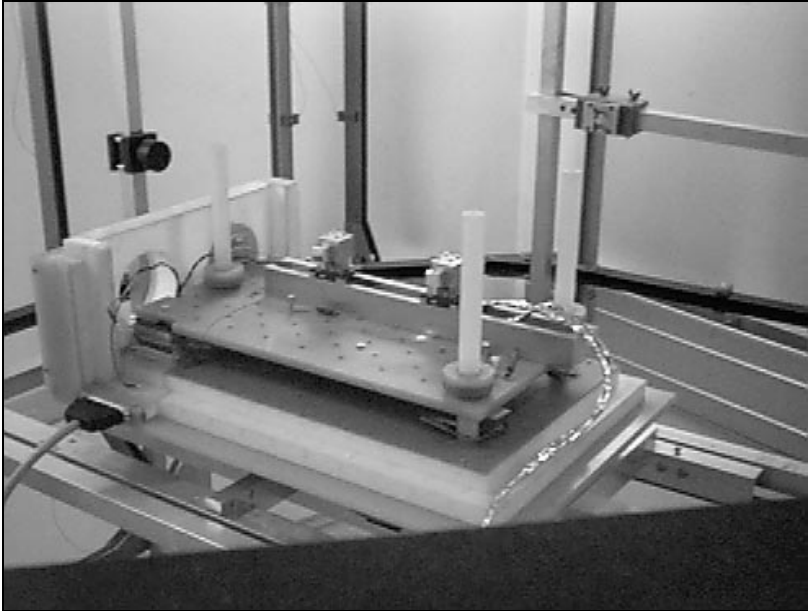

Figure 244: I010406A

F.1.6 Images 01-04-20

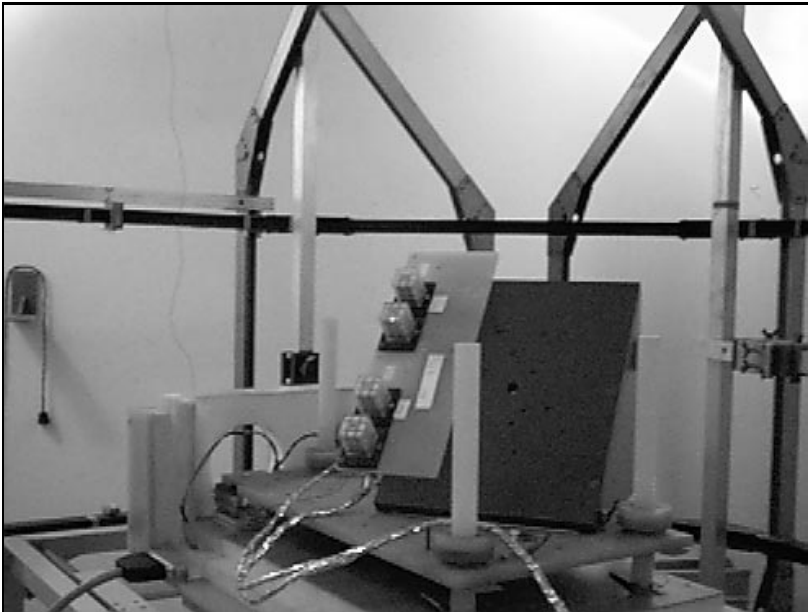

Figure 245: I010420A

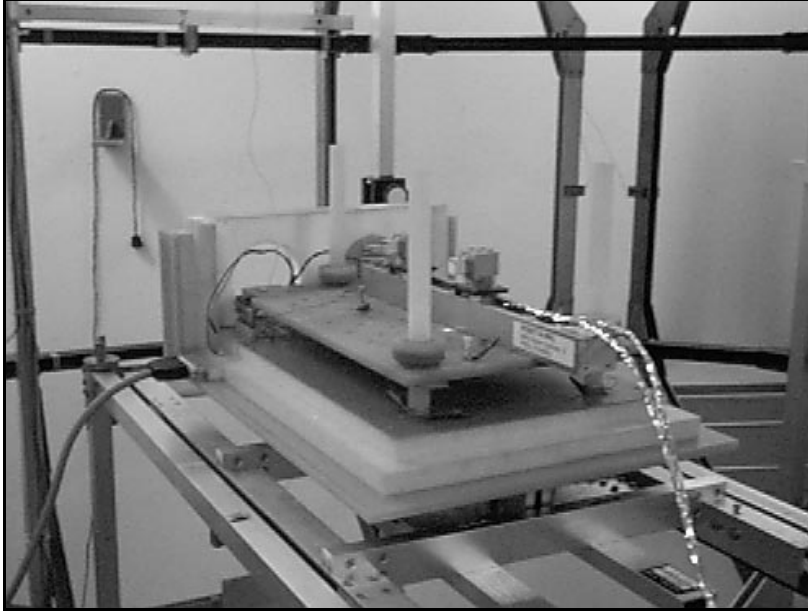

Figure 246: I010420B

F.1.7 Images 01-04-21

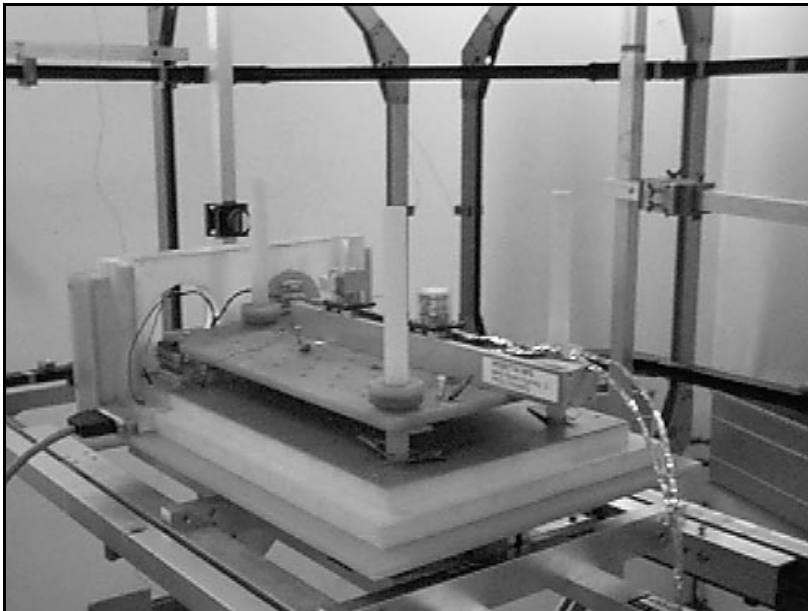

Figure 247: I010421A

F.1.8 Images 01-04-23

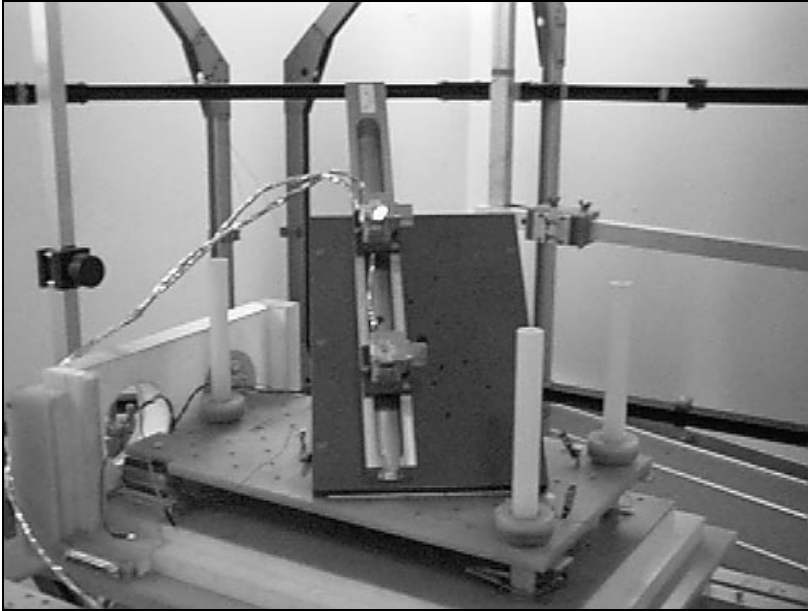

Figure 248: I010423A

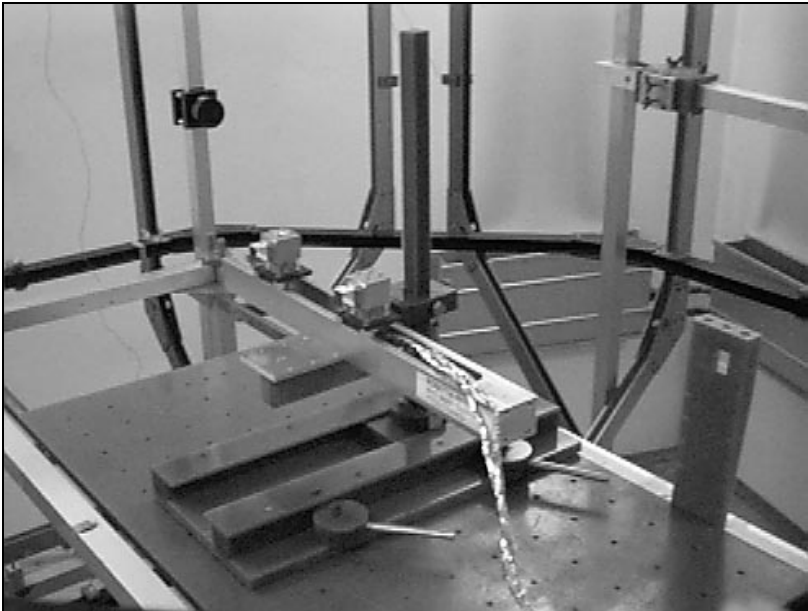

Figure 249: I010423B

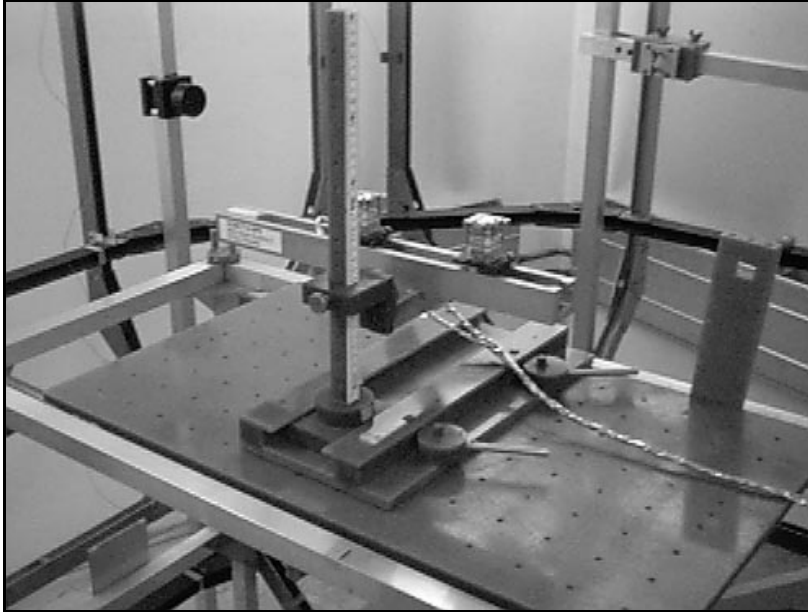

Figure 250: I010423C



Figure 251: I010423D



Figure 252: I010423E

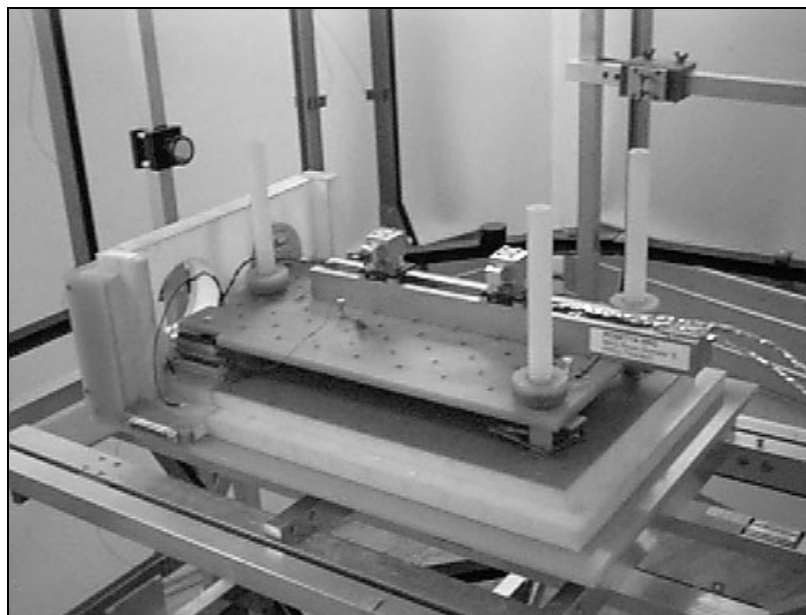

Figure 253: I010423F

F.1.9 Images 01-04-24



Figure 254: I010424A

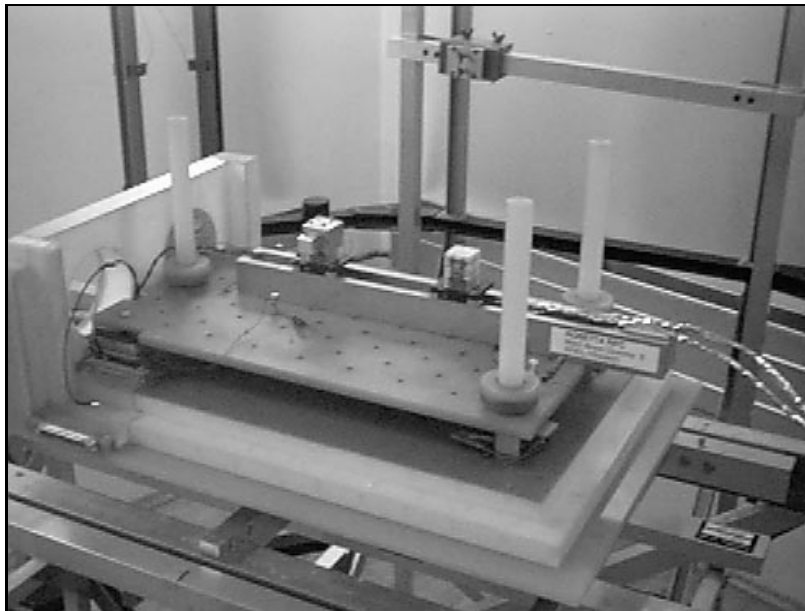

Figure 255: I010424B

F.1.10 Images 01-04-25

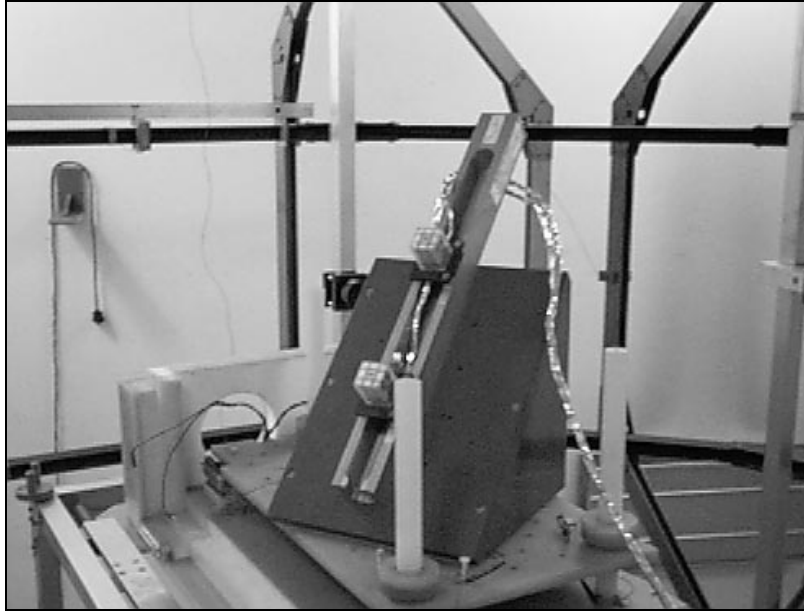

Figure 256: I010425A

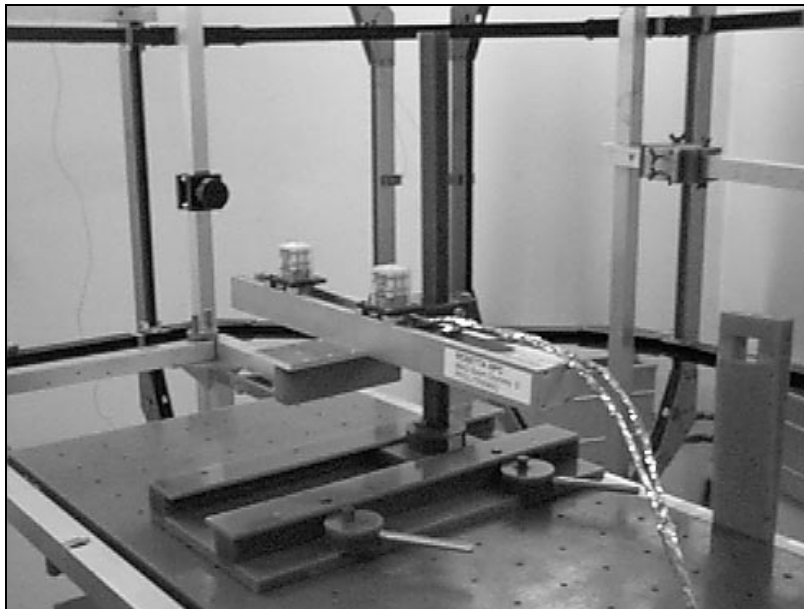

Figure 257: I010425B

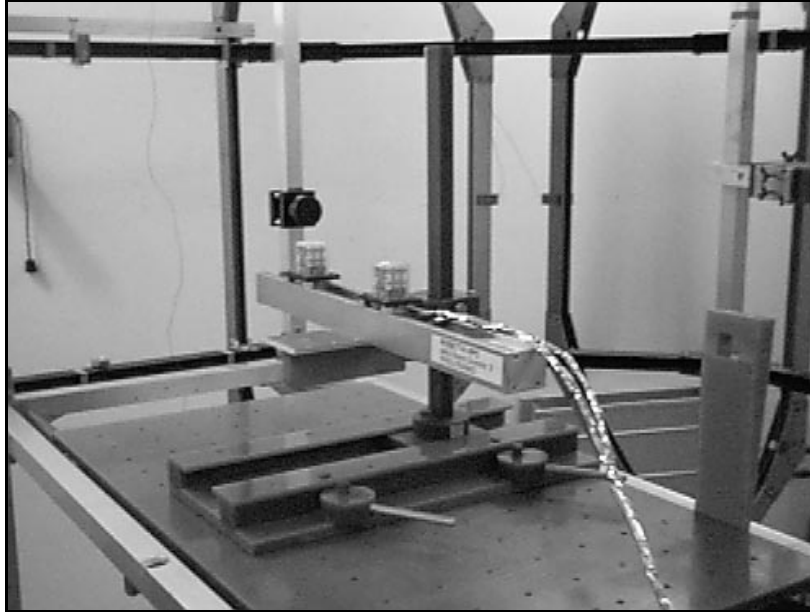

Figure 258: I010425C

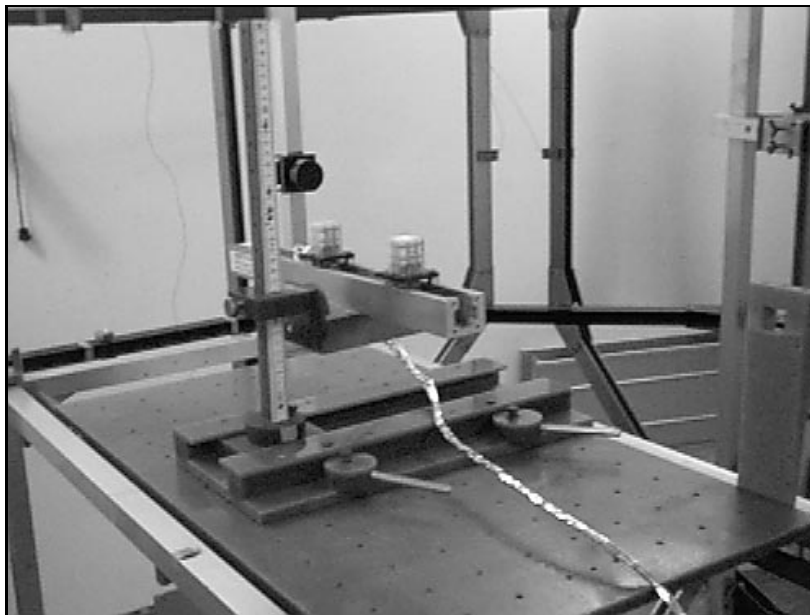

Figure 259: I010425D

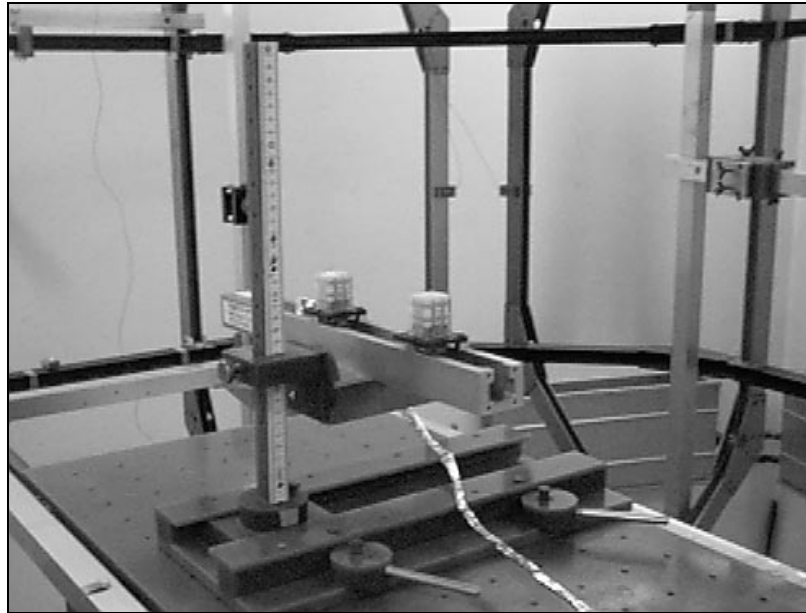

Figure 260: I010425E

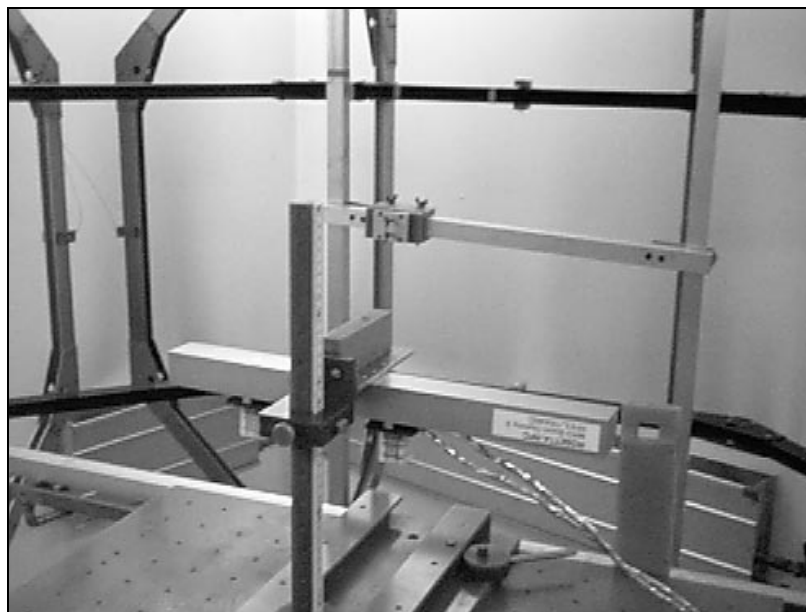

Figure 261: I010425F

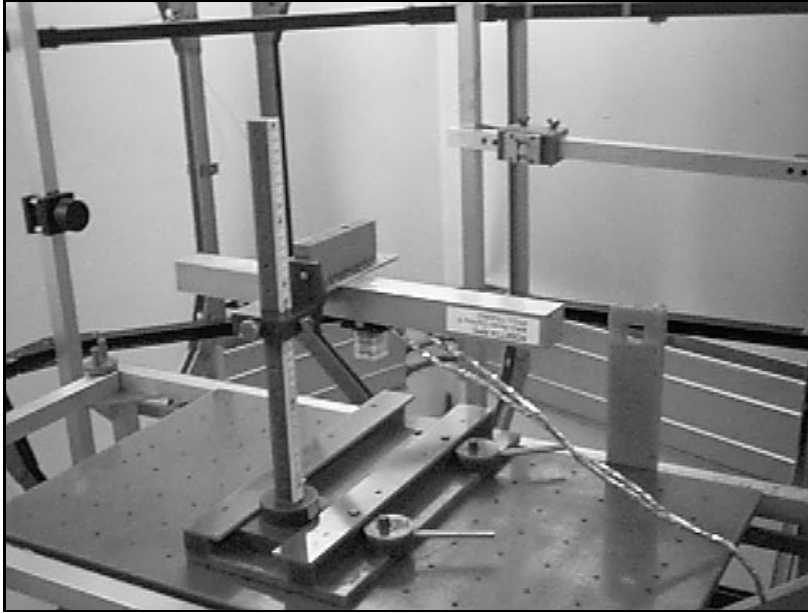

Figure 262: I010425G

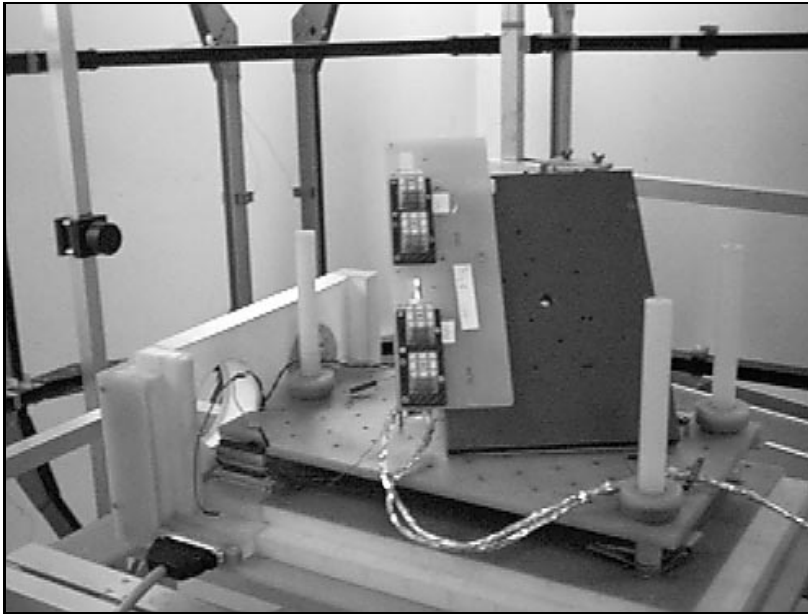

Figure 263: I010425H

F.1.11 Images 01-04-26

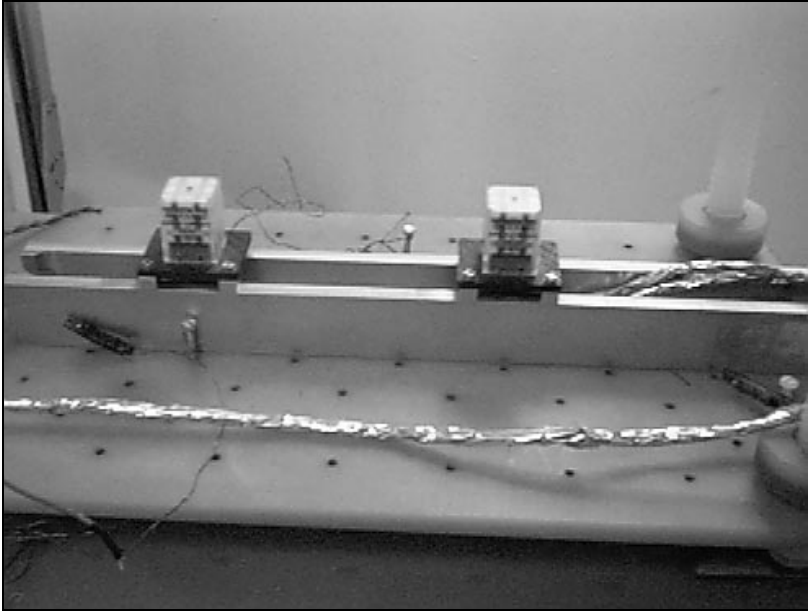

Figure 264: I010426A

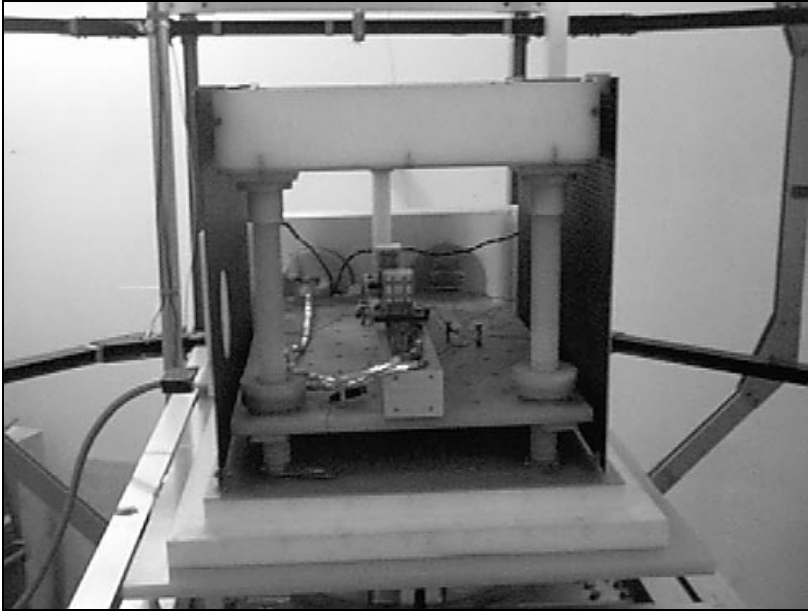

Figure 265: I010426B

F.1.12 Images 01-08-28

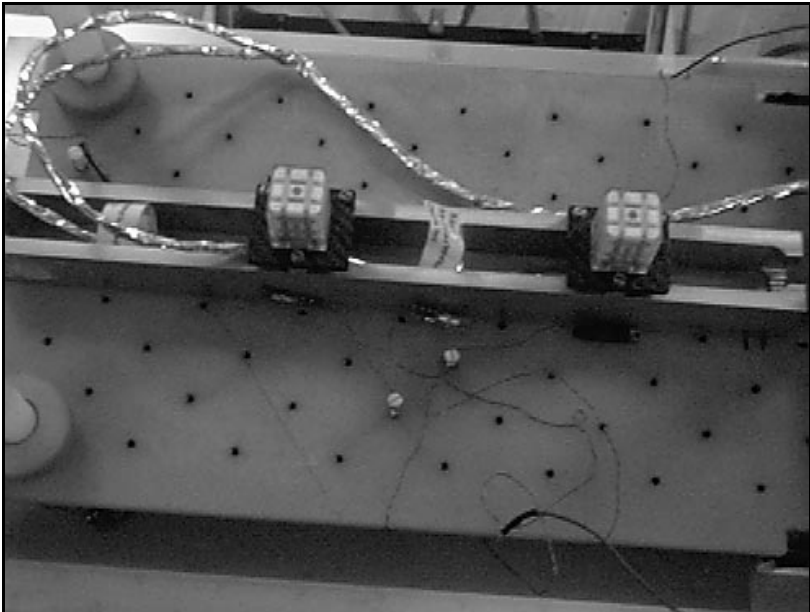

Figure 266: I010828A



Figure 267: I010828B

F.1.13 Images 01-09-13

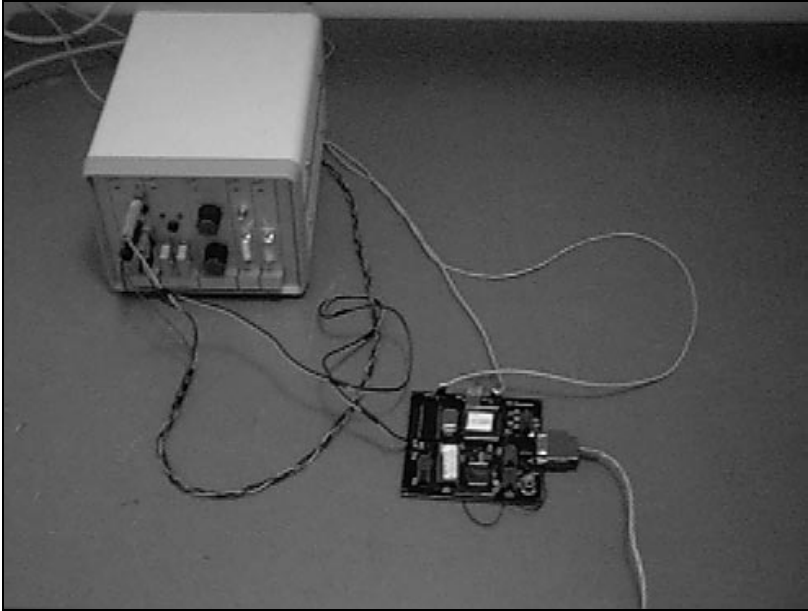

Figure 268: I010913A

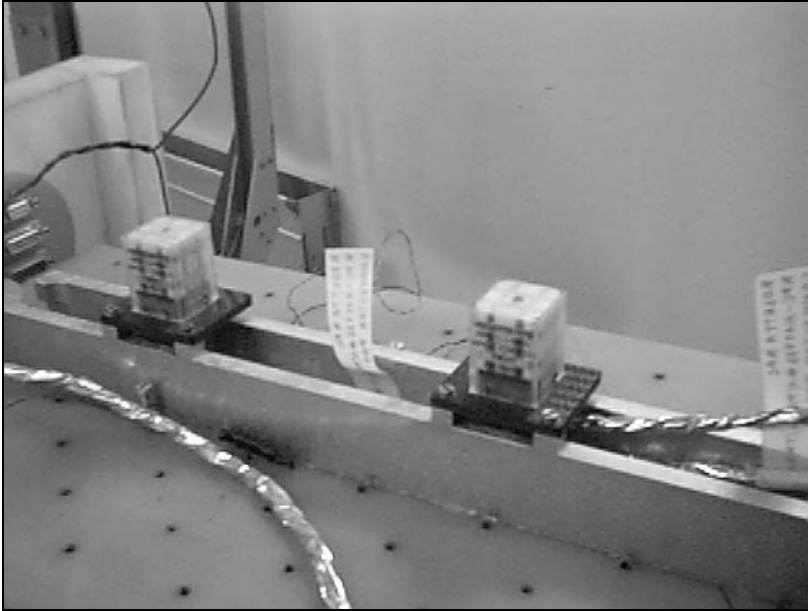

Figure 269: I010913B