

ROSETTA-RPC-MAG

To Planetary Science Archive Interface Control
Document

EAICD

RO-IGEP-TR0009

Issue 4.3
1 July 2012

Prepared by: Ingo Richter, RPC-MAG TM

Approved by: PI

Change Log

Date	Sections Changed	Reasons for Change
7.3.2005	EAICD V1.5 release	
26.9.2005	EAICD V1.7 release	PDS LABEL changes, SOFTWARE deleted
4.10.2005	RPCMAG_SW.CAT changed to RPCMAG_SOFTWARE.CAT	RPC Conventions
13.10.2005	Data Structure adapted to RPC conventions	RPC Conventions
26.10.2005	1.8, 2.4.3, 2.44, 3.11, 3.13, 3.14, 3.2.2, 3.42, 3.4.3.1,3.4.3.3, 4.3.1.6	Changes due to comments listed in RO-EST- LI-3331_1.0
18.01.2006	4.3.x	Geoindex information in DATA LBL files updated
28.09.2006	Sections mentioned in RO-EST-LI-3362	Comments on the Internal ESA Review
18.10.2006	TOC,1.5,1.9,2,22,3.1,4.2,4.3	Implementation of CLK,CLL data and Quality flags
20.4.2007	1.5.1, 1.5.2, 1.6, 1.8, 2.2.2, 2.2.6, 3.2.3, 3.42, 4.3.1.3,4.3.1.6 2.1, 2.2.3.1, 3.1.3, 3.4.3.2 4.3.1.9 4.3.2 – 4.3.15	RID related changes, Editorial Changes due to Improvement of Calibration S/W Chapter added for description of GEOMETRY Information Changes of *LBL files due to new ESA Requirements after DAWG meeting
6.8.2007		Additional changes according to RID 45
5.9.2007	2.2.2	Exact explanation of time stamps

28.10.2009		EAICD Acronym included in Acronym List, List extended with RPCMAG_INST.CAT Acronyms
26.1.2010	3.2	*LBL files updated according to S/W changes related to Archive review in October 2009 LEVEL_H description update due to LAP disturbance correction
18.2.2010	3.3	Logbook Items added
6.1.2012	4.0	Data label format changed due to NOTE Keyword, CSEQ coordsys added
3.4.2012	4.1	Reference to RPCMAG_SC_ALIGN.TXT due to RID of LUTETIA-Review
20.6.2012	4.2	Filter design added in section 2.1.3. ADC conversion revised in section 2.1.2 Changes due to RIDs of LUTETIA Review
1.7.2012	4.3	Typos corrected

TABLE OF CONTENTS

1	INTRODUCTION.....	5
1.1	PURPOSE AND SCOPE.....	5
1.2	ARCHIVING AUTHORITIES.....	5
1.3	CONTENTS.....	5
1.4	INTENDED READERSHIP.....	5
1.5	SCIENTIFIC OBJECTIVES.....	6
1.5.1	<i>Overview.....</i>	6
1.5.2	<i>The Cometary Magnetic Field - A historical perspective.....</i>	6
1.5.3	<i>The Cometary Magnetic field.....</i>	7
1.6	APPLICABLE DOCUMENTS.....	7
1.7	RELATIONSHIPS TO OTHER INTERFACES.....	8
1.8	ACRONYMS AND ABBREVIATIONS.....	8
1.9	CONTACT NAMES AND ADDRESSES.....	10
2	OVERVIEW OF INSTRUMENT DESIGN, DATA HANDLING PROCESS AND PRODUCT GENERATION.....	10
2.1	DATA HANDLING PROCESS.....	12
2.1.1	<i>Data Processing from DDS to PDS.....</i>	12
2.1.2	<i>Conversion of ADC-Counts to Physical Values.....</i>	15
2.1.3	<i>Description of the Filter – Amplitude and Phase Response.....</i>	22
2.2	OVERVIEW OF DATA PRODUCTS.....	27
2.2.1	<i>Instrument Calibrations.....</i>	27
2.2.2	<i>In-Flight Data Products.....</i>	27
2.2.3	<i>Software.....</i>	31
2.2.4	<i>Documentation.....</i>	33
2.2.5	<i>Derived and other Data Products.....</i>	33
2.2.6	<i>Ancillary Data Usage.....</i>	33
3	ARCHIVE FORMAT AND CONTENT.....	35
3.1	FORMAT AND CONVENTIONS.....	35
3.1.1	<i>Deliveries and Archive Volume Format.....</i>	35
3.1.2	<i>Data Set ID Formation.....</i>	35
3.1.3	<i>Data Directory Naming Convention.....</i>	37
3.1.4	<i>Filenaming Convention.....</i>	39
3.2	STANDARDS USED IN DATA PRODUCT GENERATION.....	41
3.2.1	<i>PDS Standards.....</i>	41
3.2.2	<i>Time Standards.....</i>	41
3.2.3	<i>Reference Systems.....</i>	42
3.2.4	<i>Other Applicable Standards.....</i>	43
3.3	DATA VALIDATION.....	43
3.4	CONTENT.....	47
3.4.1	<i>Volume Set.....</i>	47
3.4.2	<i>Data Set.....</i>	47

3.4.3	Directories.....	49
4	DETAILED INTERFACE SPECIFICATIONS.....	52
4.1	STRUCTURE AND ORGANIZATION OVERVIEW.....	52
4.2	DATA SETS, DEFINITION AND CONTENT.....	54
4.3	DATA PRODUCT DESIGN	56
4.3.1	General <i>OVERVIEW</i>	56
4.3.2	Data Product “ <i>EDITED Magnetic field data</i> ” Design.....	60
4.3.3	Data Product “ <i>EDITED Housekeeping data</i> ” Design	63
4.3.4	Data Product “ <i>CALIBRATED LEVEL_A Housekeeping data</i> ” Design.....	68
4.3.5	Data Product “ <i>CALIBRATED LEVEL_A Magnetic Field data</i> ” Design.....	72
4.3.6	Data Product “ <i>CALIBRATED LEVEL_B Magnetic Field data</i> ” Design.....	76
4.3.7	Data Product “ <i>CALIBRATED LEVEL_C Magnetic Field data</i> ” Design.....	81
4.3.8	Data Product “ <i>RESAMPLED LEVEL_K Magnetic Field data</i> ” Design.....	87
4.3.9	Data Product “ <i>RESAMPLED LEVEL_L Magnetic Field data</i> ” Design.....	91
4.3.10	Data Product “ <i>RESAMPLED LEVEL_F Magnetic Field data</i> ” Design.....	97
4.3.11	Data Product “ <i>RESAMPLED LEVEL_G Magnetic Field data</i> ” Design.....	101
4.3.12	Data Product “ <i>RESAMPLED LEVEL_H Magnetic Field data</i> ” Design.....	106
4.3.13	Data Product “ <i>RESAMPLED LEVEL_I Magnetic Field data</i> ” Design.....	111
4.3.14	Data Product “ <i>DERIVED LEVEL_J Magnetic Field data</i> ” Design.....	112
5	APPENDIX: AVAILABLE SOFTWARE TO READ PDS FILES	117
6	APPENDIX: EXAMPLE OF DIRECTORY LISTING OF DATA SET X	117

1 Introduction

1.1 Purpose and Scope

The purpose of this EAICD (Experimenter to (Science) Archive Interface Control Document) is two fold. First it provides users of the RPC-MAG with detailed description of the product and a description of how it was generated, including data sources and destinations. Secondly, it is the official interface between your instrument team and your archiving authority.

1.2 Archiving Authorities

The Planetary Data System Standard is used as archiving standard by

- NASA for U.S. planetary missions, implemented by PDS
- ESA for European planetary missions, implemented by the Research and Scientific Support Department (RSSD) of ESA

ESA implements an online science archive, the PSA,

- to support and ease data ingestion
- to offer additional services to the scientific user community and science operations teams as e.g.
 - search queries that allow searches across instruments, missions and scientific disciplines
 - several data delivery options as
 - direct download of data products, linked files and data sets
 - ftp download of data products, linked files and data sets

The PSA aims for online ingestion of logical archive volumes and will offer the creation of physical archive volumes on request.

1.3 Contents

This document describes the data flow of the RPC-MAG instrument on ROSETTA from the s/c until the insertion into the PSA for ESA. It includes information on how data were processed, formatted, labeled and uniquely identified. The document discusses general naming schemes for data volumes, data sets, data and label files. Standards used to generate the product are explained. Software that may be used to access the product is explained further on.

The design of the data set structure and the data product is given. Examples of these are given in the appendix.

1.4 Intended Readership

The staff of the archiving authority (Planetary Science Archive, ESA, RSSD, design team) and any potential user of the RPC-MAG data.

1.5 Scientific Objectives

1.5.1 Overview

The ROSETTA orbiter magnetometer is part of the ROSETTA Plasma Consortium set of scientific instruments. The purpose of the magnetometer is the measurement of the interplanetary magnetic field close to different targets visited by the ROSETTA spacecraft.

Special points of interest are:

- Measurements of the interplanetary magnetic field during the flybys at planet Mars & Earth, the asteroids and in the environment of comet p/Churyumov Gerasimenko.
- Study of the structure and dynamics of the cometary-solar wind interaction region.
- Study of the generation and evolution of the cometary magnetic Cavity.
- Study of cometary tail evolution and structure.

1.5.2 The Cometary Magnetic Field - A historical perspective

In 1951 the German Astronomer Ludwig Biermann used the fact that cometary tails are always pointing away from the Sun to postulate the solar wind.

It was Hannes Alfvén who suggested in 1957 that cometary tails are due to the draping of the interplanetary magnetic field around the cometary nucleus.

To explain this draping effect C.S. Wu and R.C. Davidson in 1972 studied the pick-up of cometary ions and the associated mass loading of the solar wind.

Associated strong plasma wave turbulence due to this mass loading was first detected by B.T. Tsurutani and E.J. Smith in 1986.

The magnetic field draping itself was first measured by F. M. Neubauer and co-workers using magnetic field measurements made onboard the GIOTTO spacecraft.

1.5.3 The Cometary Magnetic field

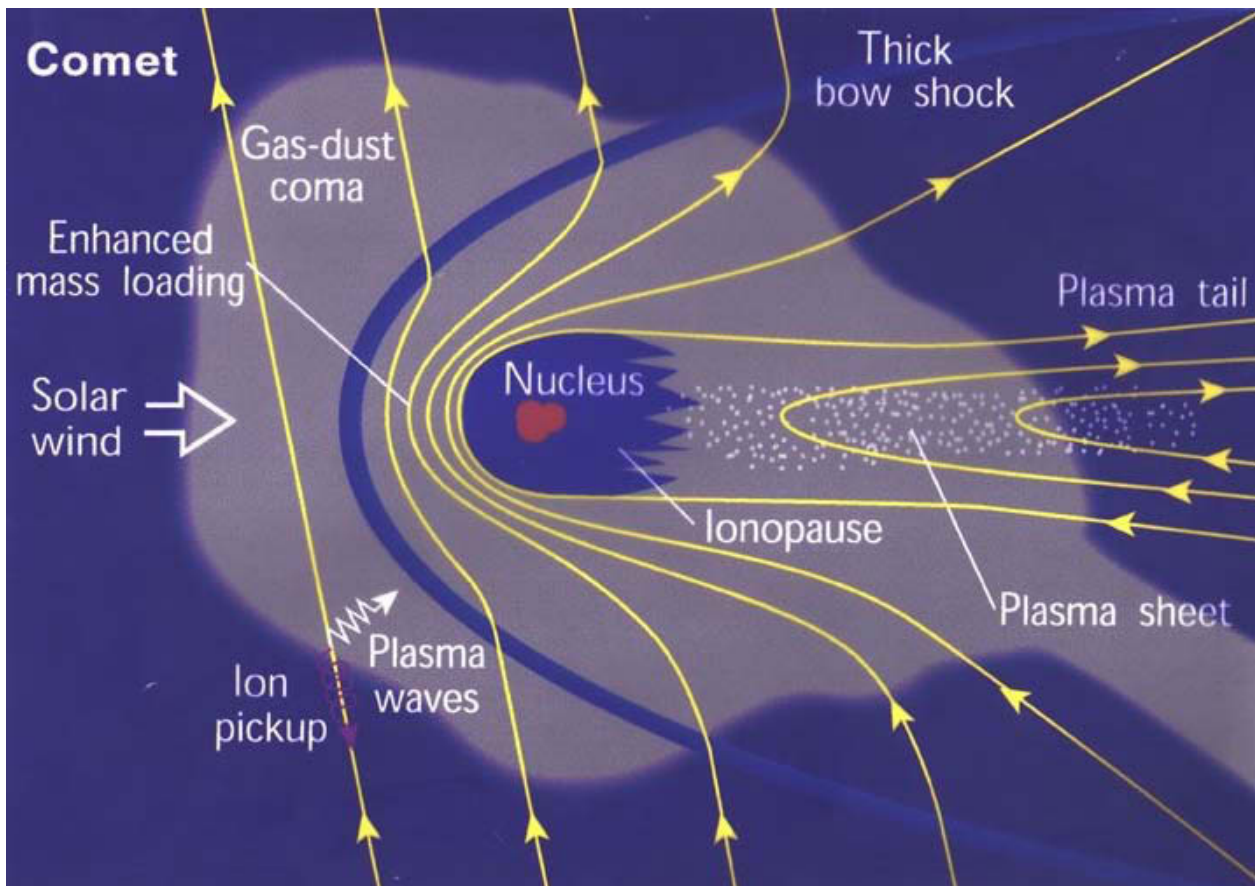

1.6 Applicable Documents

- Planetary Data System Data Preparation Workbook, February 1, 1995, Version 3.1, JPL, D-7669, Part1
- Planetary Data System Standards Reference, August 1, 2003, Version 3.6, JPL, D-7669, Part 2
- ROSETTA, Archive Generation, Validation and Transfer Plan, January 10, 2006, RO-EST-PL-5011
- RPC-MAG Knowledge Management, Power-Point Presentation and Video (RO-3DSE-MAG)
- RO-RPC-UM, Rosetta Plasma Consortium: User's Manual
- RO-IGM-TR-0002, Fluxgate Magnetometer Calibration for Rosetta: Report on the FM and FS Calibration
- RO-IGM-TR-0003, Fluxgate Magnetometer Calibration for Rosetta: Analysis of the FM Calibration
- RO-IWF-TR-0001, Calibration Report, Sample Rate and Frequency Response - Analysis of ROSETTA RPCMAG
- RO-IGEP-TR-0007, DDS2PDS User Manual
- RO-IGEP-TR-0016, RPC Archiving Guidelines
- RO-IGEP-TR-0028, RPCMAG Step by step Calibration Procedure

1.7 Relationships to Other Interfaces

This EAICD describes the overall RPC-MAG archiving details. If there will be changes in the DDS2PDS Software, this EAICD and the DDS2PDS User manual, RO-IGM-TR0007, will be affected. Changes of the EAICD will not have any feedback to other documents, as the EAICD is changed at the end of the chain, taking into account any other document update made before

1.8 Acronyms and Abbreviations

ADC:	Analog-Digital-Converter
AQP:	Acquisition Period
ASIC:	Application Specific Integrated Circuit
B-FIELD:	Magnetic Field
CG:	67P/Churyumov-Gerasimenko
CO-I:	Co-Investigator
CuL:	Kupferlackdraht, Enamelled copper wire
DDS:	Data Distribution System
DPU:	Digital Processing Unit
DS-1:	NASA's Deepspace 1 Mission
EAICD:	Experimenter to Archive Interface Control Document
EID-B:	Experiment Interface Document , Part B
EMC:	Electromagnetic Compatibility
ESA:	European Space Agency
ESTEC:	European Space Research and Technology Centre
FGM:	Fluxgate-Magnetometer
FM:	Flight Model
FMECA:	Failure Mode Effects and Criticality Analysis
FPGA:	Field programmable Gate Array
FCP:	Flight Control Procedure
FS:	Flight Spare Model
HK:	Housekeeping data (Supply voltages, Ref. Voltages, Temperatures)
H/W:	Hardware
IABG:	Industrieanlagenbetriebsgesellschaft
IB:	Inboard Sensor
ID:	Identifier
I/F:	Interface
IGEP:	Institut fuer Geophysik und extraterrestrische Physik, TU-Braunschweig
IWF:	Institut fuer Weltraumforschung, Graz

LCL:	Latching Current Limiter
LEXAN:	Polycarbonate resin thermoplastic
MACOR:	Machinable glas ceramic
MAG:	Magnetometer
MIP:	RPC Mutual Impedance Probe
NASA:	National Aeronautics and Space Administration
OB:	Outboard Sensor
OPAMP:	Operational Amplifier
PCB:	Printed Circuit Board
PDS:	Planetary Data System
PERMALLOY:	Nickel Iron magnetic alloy
PI:	Principal Investigator
PIU:	RPC Power Interface Unit
PSA:	Planetary Science Archive
PT1000:	Platinum Thermistor with 1000 Ohm nominal resistance
RAW:	Data in units of ADC counts in instrument coordinates
ROKSY:	ROSETTA Knowledge Management System
ROMAP:	ROSETTA Lander Magnetometer
RPC:	ROSETTA Plasma Consortium
RPCMAG:	ROSETTA Orbiter Magnetometer
RPC-MAG:	ROSETTA Orbiter Magnetometer
RPC-0:	RPC Main Electronics Box
SADM:	Solar Array Drive Mechanism
S/C:	Spacecraft
SID:	Science Mode Identifier
S/W:	Software
SEU:	Single Event Upset
SEL:	Single Event Latch-up
TC:	Telecommand
TM:	Telemetry
TM:	Technical Manager
TS:	Time series
UV:	Ultraviolet
us:	microsecond
Wrt.:	with respect to

1.9 Contact Names and Addresses

PI: Prof. Dr. Karl-Heinz Glassmeier, IGEP, Mendelssohnstr. 3 , 38106 Braunschweig,
+49 531 391 5215 , kh.glassmeier@tu-bs.de

TM: Dr. Ingo Richter, IGEP, Mendelssohnstr. 3 , 38106 Braunschweig,
+49 531 391 5223 , i.richter@tu-bs.de

Responsible for the RAW2ASCII S/W, which converts Raw TM files to ASCII files:

Hans Eichelberger, Space Research Institute (IWF), Austrian Academy of Sciences, Schmiedlstr. 6,
8042 Graz, +43 316 4120 557, hue@oeaw.ac.at

2 Overview of Instrument Design, Data Handling Process and Product Generation

The ROSETTA orbiter magnetometer is part of the ROSETTA Plasma Consortium set of scientific instruments. The purpose of the magnetometer is the measurement of the interplanetary magnetic field close to different targets visited by the ROSETTA spacecraft.

To measure the magnetic field a system of two ultra light triaxial fluxgate magnetometers (about 36 g each) is used, with the outboard (OB) sensor mounted close to the tip of the about 1.55 m long spacecraft boom pointing away from the comet nucleus and with the inboard (IB) sensor on the same boom about 15 cm closer to the spacecraft body. The OB position on the boom is at 1.48m, the IB position is at 1.33m distance from the spacecraft. Two magnetometer sensors are required to minimise the influence of the rather complex spacecraft field on the actual measurements, and for redundancy purposes.

In order to meet the scientific requirements as discussed above the spacecraft magnetic DC-field requirement is about 25 nT at the outboard MAG sensor. To achieve this goal a magnetic cleanliness programme was planned, conducted by the experimenter team, supported by the ROSETTA project.

To further eliminate spacecraft fields and zero-offsets the so called multi-magnetometer technique will be applied in conjunction with statistical in-flight techniques. To increase time resolution 6 A/D converters (one for each of the six sensor channels) will be used synchronously. The A/D converters have a resolution of 20 bits each. MAG will be operated with a high temporal resolution of about 20 vectors/sec outboard and inboard. Transmission of number of vectors/sec respectively burst mode memory operation will be adopted to available data rate by averaging of vector rate inside the PIU-DPU.

The Orbiter Magnetometer RPCMAG can be characterized by the following features:

- Fluxgate-Magnetometer with a resolution of +/- 31 pT
- Measurement Range ; +/- 16384 nT
- 2 Sensors: Outboard (OB) / Inboard (IB)
- 20 Bit ADC
- Measuring B-Field in 3 components with a maximum vector rate of 20 Hz.
- The Flux-Gate Magnetometer RPC-MAG performance parameters are in full accordance with the EID-B design goals

- The Outboard/ Inboard sampling rate can be inverted by command either for higher Inboard time resolution or in case of outboard failure.
- The sensors are fully calibrated also versus a wide temperature range.
- The temperature at Outboard and Inboard sensor is monitored in MAG housekeeping data.
- The instrument delivers time series of the 3 dimensional magnetic field vector.

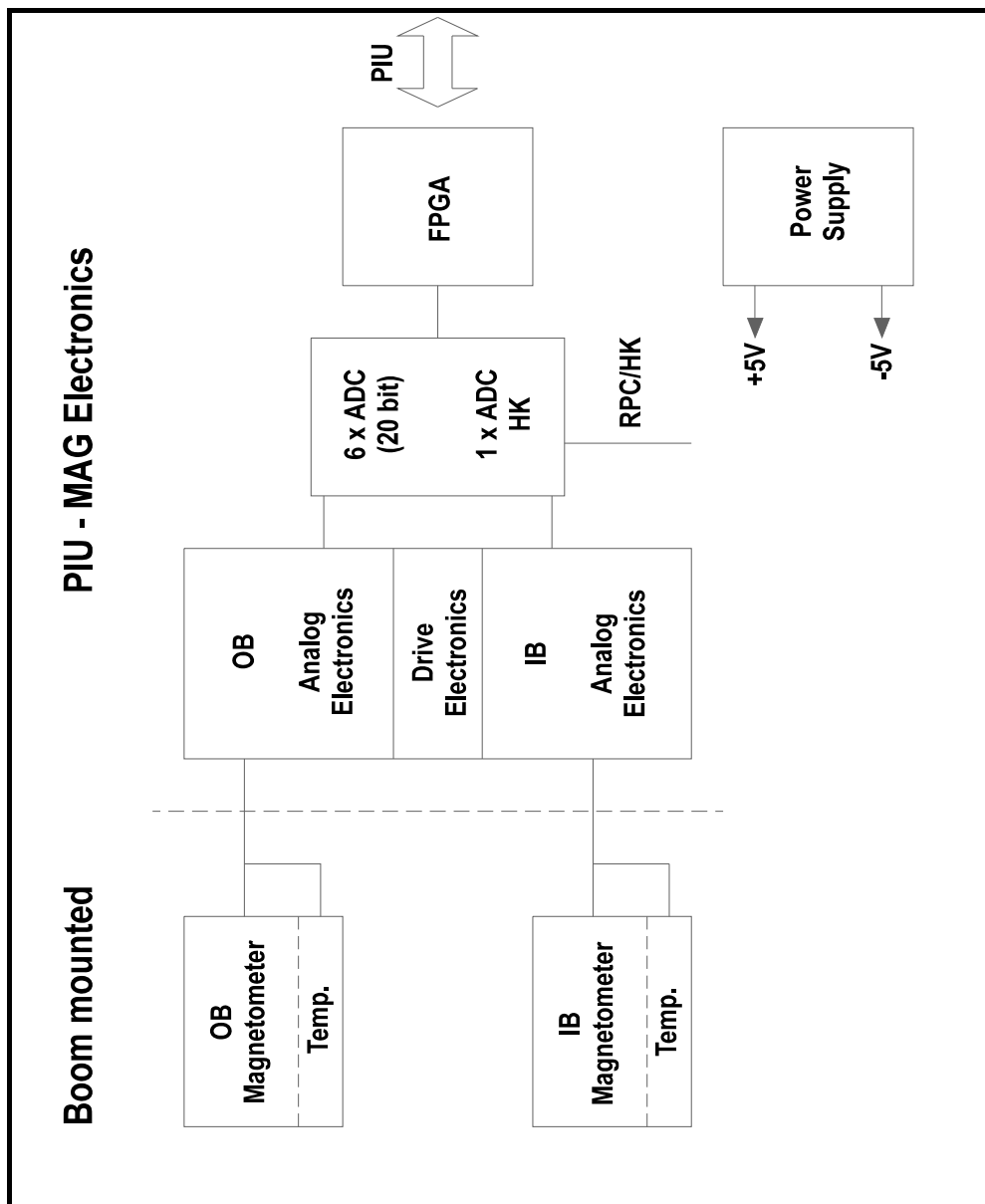

Block diagram of the RPCMAG Instrument

2.1 Data Handling Process

The RPC-MAG data are provided by IGEP using the DDS2PDS S/W package.

2.1.1 Data Processing from DDS to PDS

Details can be found in the DDS2PDS User Manual RO-IGEP-TR0007.

- The overall data processing can be done mainly by the IDL S/W package **DDS2PDS**. This consists of several routines for different purposes:
 - Copying TM raw data from our ftp-server to the local analysis PC
 - Converting /Decoding these binary data to ASCII data. This is done by calling the MATLAB S/W **RAW2ASCII** from the IDL program.
 - Reading Attitude and Orbit file (*.ROS) from the ftp server
 - Calling the OASWLIB S/W to generate desired attitude and orbit vectors
 - Generating PDS Files from these ASCII raw data (Routine: **GEN_CAL_DATA**)
 - Generating Plots
 - Elimination of Reaction wheel influence
 - Elimination of LAP Disturbance
 - Considering Lander heater current disturbance
 - Setting Quality flags to CALIBRATED, RESAMPLED, and DERIVED data
 - Generating log files

- Binary TM data can be just read and converted to ASCII by **RAW2ASCII**

Program Details:

- developed in MATLAB under Windows by Hans Eichelberger, IWF, GRAZ
- this S/W acts as I/F between the binary raw data transmitted by the DDS/EGSE/IC-FTP server and the scientific usable data.
- The program converts binary raw data into ASCII data and adds the necessary time information (UTC) for the subsequent scientific analysis. Bad vectors are marked. All written ASCII files get a header starting with #
- It reads
 - Magnetic field raw data in all modes (SID1 - SID6)
 - Temperature data (IB/OB)
 - HK data
- The program can be executed via a batch job to guarantee a more or less automatic data generation/conversion process.
- The converted ASCII data will be merged with auxiliary data and processed with **GEN_CAL_DATA** to obtain scientific usable data in PDS format. This IDL routine acts as I/F between the ASCII raw data converted by RAW2ASCII and the PDS System.
 - GEN_CAL_DATA reads (files can be read from a list for automatic data generation)

Magnetic field ASCII raw data:

RPCMAGyymmddThhmm_RAW_<sensor>_<MODE>.ASS
 Auxiliary data - Attitude: ATyyyymmdd.ROS
 Auxiliary data - Position: POSyymmdd.ROS
 Housekeeping data: RPCMAGyymmddThhmm_RAW_HK.ASC
 Calibration files: RPCMAG_GND_CALIB_FSDPU_FM<sensor>.TXT,
 Boom alignment file: RPCMAG_SC_ALIGN.TXT

- Functions of GEN_CAL_DATA:
 - 1) apply temperature dependent ground calibration results to get B-field in unit coordinates.
 - 2) apply actual "inflight" temperature model to get rid of temperature influence. This model has to be created with assistance of the IDL S/W CALIB_ROS_TEMP_xxxx before.
 - 2) turn B-field from instrument to s/c coordinates
 - 3) apply attitude data to get B-field in EME2000 frame (or a similar one)
 - 4) apply filters, spike detectors,.... data processing routines to get ``scientific usable magnetic field data`` in ASCII time series.
- GEN_CAL_DATA writes

PDS compliant calibrated data files and labels on different stages (*.tab, *.lbl).

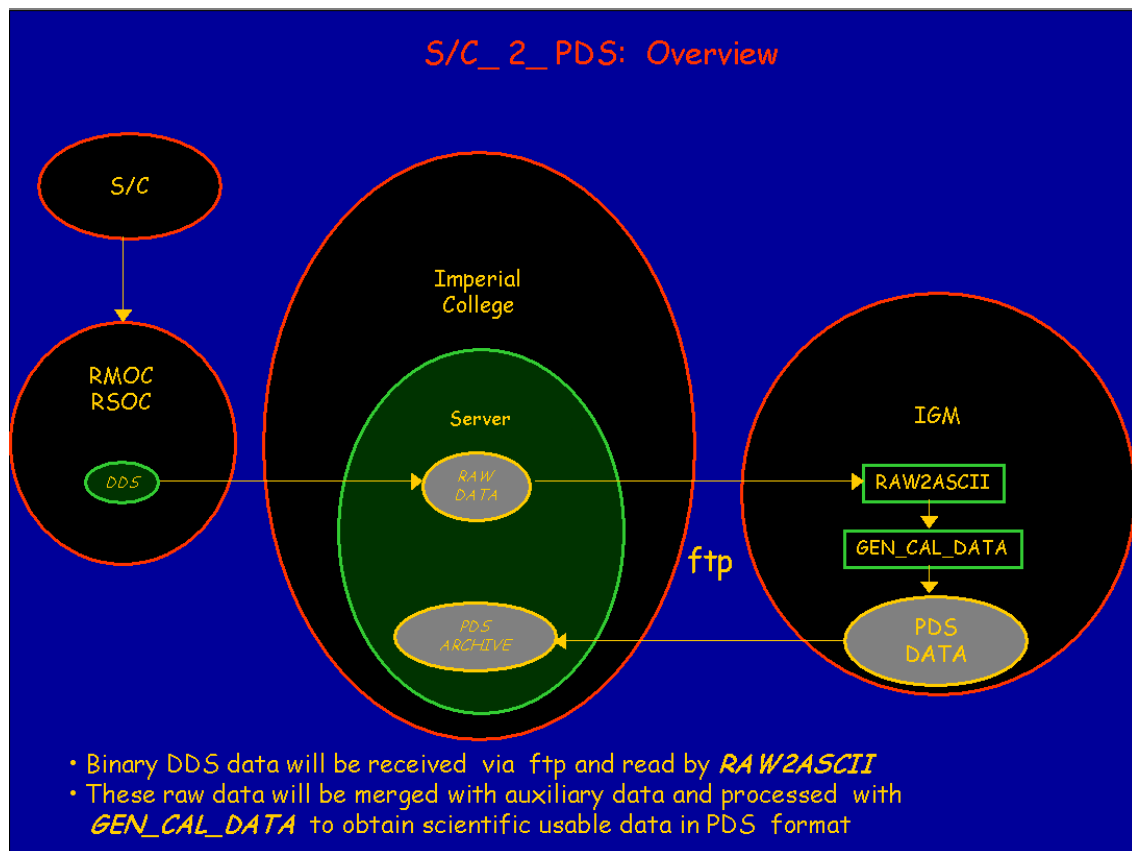

After generating all the dataset and checking them with PVV the data are copy (via SCP) to the Imperial college SFTP server. From here all RPC data will be sent (sftp'ed) to the PSA. This last step is under responsibility of our overall RPC archive engineer.

2.1.2 Conversion of ADC-Counts to Physical Values

The measured values of the instrument are digitized by ADC-converters. The conversion from the raw ADC-counts to meaningful physical raw values (still uncalibrated) is different for magnetic field values and housekeeping values like e.g. instrument voltages. The following subsections show detailed algorithms of the conversion from ADC counts to physical values

- **General Remarks**

RPCMAG contains seven 20bit ADCs. 3 are used for the digitalization of magnetic field data measured by the OB sensor, 3 are used for the magnetic field data of the IB sensor, and the seventh, which is operated with a multiplexer, converts various Housekeeping (HK) data.

The reference voltage of the ADCs is 2.5 V. The converters are operated in a bipolar mode, thus input voltages in the range of +-2.5V can be converted. The relation of input voltage and counts is:

00000h <-> -2.5V

80000h <-> 0V

FFFFFFh <-> +2.5V

Due to the small input range some voltage adaption has to be done in the MAG instrument for certain HK values:

- * the 2.5V reference voltage is monitored behind a voltage divider

$100016 \text{ Ohm} / (100000 \text{ Ohm} + 100016 \text{ Ohm}) = 0.499$ as 1.2497V nominal voltage.

- * the +5V supply voltage is monitored behind a voltage divider

$90956 \text{ Ohm} / (99972 \text{ Ohm} + 90956 \text{ Ohm}) = 0.476$ as 2.38V nominal voltage.

- * the -5V supply voltage is monitored behind a voltage divider

$27400 \text{ Ohm} / (100024 \text{ Ohm} + 27400 \text{ Ohm}) = 0.215$ as -0.997 V nominal voltage.

- * the temperatures are measured as the voltage drop of PT1000 thermistors connected to the 2.5V reference voltage via a 1kOhm serial resistor: $U(T) = U_{ref} * (1 / (R_{ser} / R(T) + 1))$. Therefore, the nominal voltages at 273K are 1.25V. Conversion to temperatures are obtained by application of 3rd order polynomials.

RPCMAG sends always 20bit data to the PIU. The PIU reduces the amount of data in the following way:

- **Science data:**

<i>Data</i>	<i>PIU-Input</i>	<i>PIU-Output</i>	<i>PIU-Operation</i>
Magnetic field IB	20 bit	20 bit	subtract 2^{19}
Magnetic field OB	20 bit	20 bit	subtract 2^{19}

- **Housekeeping data:**

<i>Data</i>	<i>PIU-Input</i>	<i>PIU-Output</i>	<i>PIU-Operation</i>
Magnetic field OB	20bit	16bit	subtract 2 ¹⁹ right shift by 4 digits
2.5V Ref. Voltage	20bit	20bit	subtract 2 ¹⁹
+5V Supply Voltage	20bit	8bit	subtract 2 ¹⁹ right shift by 4digits subtract offset 79F7h right shift by 4 digits
-5V Supply Voltage	20bit	8bit	subtract 2 ¹⁹ right shift by 4digits subtract offset -370Eh right shift by 3 digits
Temperature OB	20bit	16bit	subtract 2 ¹⁹ right shift by 4 digits
Temperature IB	20bit	16bit	subtract 2 ¹⁹ right shift by 4 digits

- Detailed description of the conversion

1) Science Data: Magnetic field (range = +/-15000nT, 20 Bit):

Definitions:

B_max = +15000 nT

B_min = -15000 nT

counts20 = 2^{20} = 1048576

Nominal_Factor = $(B_{max} - B_{min}) / (counts20-1)$

The TLM data contain signed 20bit data. The data range of these values in decimal representation is $-(counts20/2) \dots +counts20/2-1$. These signed integers are the EDITED RAW DATA. Unit is [counts].

In the first step of conversion to physical values an offset of $counts20/2$ is added, which yields to data in the range of 00000h:FFFFh. The nominal relation between these converted TLM data and magnetic field is now as follows:

00000h <-> B_min

80000h <-> 0

FFFFh <-> B_max

To convert these data into uncalibrated [engineering, enT] nanotesla values, the following algorithm has to be applied:

$$B = [TLMdata + counts20/2] * Nominal_Factor + B_{min} \text{ [enT]}$$

2) Housekeeping Data: Magnetic field (range = +/-16384nT, 16 Bit):

Definitions:

B_max = +16384 nT

B_min = -16384 nT

counts16 = 2^{16} = 65536

Nominal_Factor = $(B_{max} - B_{min}) / (counts16-1)$

The TLM data contain 16bit data. The relation between the ADCvalues and the PIU output (TLM) is: $TLM = (ADCvalue - 2^{19}) \text{ shr } 4$. The data range of these TLM data is $0 \dots +counts16-1$. The decimal representation of these unsigned integers are the EDITED RAW HK DATA. Unit is [counts].

In the first step of the conversion to physical values an offset of $counts16/2$ is added if the value is smaller than $counts16/2$ and subtracted in the other case. The nominal relation between these converted data and magnetic field is now as follows:

0000h <-> B_min
8000h <-> 0
FFFFh <-> B_max

To convert these values into uncalibrated [engineering, enT] nanotesla values, the following algorithm has to be applied:

$$B = \text{converted data} * \text{Nominal_Factor} + B_min \text{ [enT]}$$

3) Housekeeping Data: 2.5V Reference Voltage (Typical divided input voltage: 1.2497V, 20 Bit)

Definitions:

$$U_max = +2.5 \text{ V}$$

$$U_min = -2.5 \text{ V}$$

$$\text{counts20} = 2^{20} = 1048576$$

$$\text{volt_divider} = 100016/200016 = 0.49996$$

$$\text{Nominal_Factor} = (U_max - U_min) / (\text{counts20}-1)$$

The TLM data contain 20bit data. The relation between the ADCvalues and the PIU output (TLM) is: $TLM = (\text{ADCvalue} - 2^{19})$. The data range of these TLM data is 0...+counts20-1. The decimal representation of these unsigned integers are the EDITED RAW HK DATA. Unit is [counts].

In the first step of the conversion to physical values an offset of counts20/2 is added if the value is smaller than counts20/2 and subtracted in the other case. The nominal relation between these converted data and magnetic field is now as follows:

$$0000h \text{ <-> } U_min$$

$$8000h \text{ <-> } 0$$

$$FFFFh \text{ <-> } U_max$$

To convert these values into voltages the following algorithm has to be applied:

$$U_REF = (\text{converted data} * \text{Nominal_Factor} + U_min) / \text{volt_divider} \text{ [V]}$$

4) Housekeeping Data: +5V Supply Voltage (Typical divided input voltage: 2.38V, 8 Bit)

Definitions:

$$U_{\max} = +2.5 \text{ V}$$

$$U_{\min} = -2.5 \text{ V}$$

$$U_{\text{Ref}} = +2.4996 \text{ V}$$

$$U_{\text{center}} = +5.0\text{V}$$

$$\text{counts8} = 2^8 = 256$$

$$\text{volt_divider} = 90956/(99972+90956) = 0.476389$$

$$\text{cal_fak} = U_{\text{ref}} / (\text{counts}20-1) / \text{volt_divider} * 512 = 0.002562$$

The TLM data contain 8bit data. The relation between the ADCvalues and the PIU output (TLM) is: $TLM = (((ADCvalue - 2^{19}) \text{ shr } 4) - 79F7h) \text{ shr } 4$). The data range of these TLM data is 0...+counts8-1. The decimal representation of these unsigned integers are the EDITED RAW HK DATA. Unit is [counts].

In the first step of the conversion to physical values these unsigned integer TLM values are converted to signed integers, thus an offset of counts8 is subtracted if the value is greater than counts8/2. the nominal relation between these converted data and the original voltage is now as follows:

$$80h = -128d \leftrightarrow 4.673V$$

$$00h = 0d \leftrightarrow 5.000V$$

$$7Fh = 127d \leftrightarrow 5.327V$$

To convert these values into voltages, the following algorithm has to be applied:

$$U_{\text{plus}} = \text{cal_fak} * \text{converted data} + U_{\text{center}} \text{ [V]}$$

5) Housekeeping Data: -5V Supply Voltage

(Typical divided input voltage: 0.997 V, 8 Bit)

Definitions:

$$U_{\max} = +2.5 \text{ V}$$

$$U_{\min} = -2.5 \text{ V}$$

$$U_{\text{Ref}} = +2.4996 \text{ V}$$

$$U_{\text{center}} = -5.0\text{V}$$

$$\text{counts8} = 2^8 = 256$$

$$\text{volt_divider} = 27400/(100024+27400) = 0.21503$$

$$\text{cal_fak} = U_{\text{ref}} / (\text{counts}20-1) / \text{volt_divider} * 256 = 0.002838$$

The TLM data contain 8bit data. The relation between the ADCvalues and the PIU output (TLM) is:

$$\text{TLM} = (((\text{ADCvalue} \cdot 2^{19}) \text{ shr } 4) + 370\text{Eh}) \text{ shr } 3$$

The data range of these TLM data is 0...+counts8-1.

The decimal representation of these unsigned integers are the EDITED RAW HK DATA. Unit is [counts].

In the first step of the conversion to physical values these unsigned integer TLM values are converted to signed integers, thus an offset of counts8 is subtracted if the value is greater than counts8/2.

The nominal relation between these converted data and the original voltages is now as follows:

$$80\text{h} = -128\text{d} \leftrightarrow -5.36\text{V}$$

$$00\text{h} = 0\text{d} \leftrightarrow -5.00\text{V}$$

$$7\text{Fh} = 127\text{d} \leftrightarrow -4.64\text{V}$$

To convert these values into voltages, the following algorithm has to be applied:

$$U_{\text{minus}} = \text{cal_fak} * \text{converted data} + U_{\text{center}} \quad [\text{V}]$$

6) Housekeeping Data: Temperatures (range = +-200 °C, 16 Bit)
(Related input voltages: 0.5...1.6V, 16 Bit)

Definitions:

$$U_{\max} = +2.5V$$

$$U_{\min} = -2.5V$$

$$\text{counts}_{16} = 2^{16} = 65536$$

$$\text{Nominal_Factor} = (U_{\max} - U_{\min}) / (\text{counts}_{16} - 1)$$

The TLM data contain 16bit data. The relation between the ADCvalues and the PIU output (TLM) is: $TLM = (\text{ADCvalue} - 2^{19}) \text{shr } 4$. The data range of these TLM data is $0 \dots \text{counts}_{16} - 1$. The decimal representation of these unsigned integers are the EDITED RAW HK DATA. Unit is [counts].

In the first step of the conversion to physical values an offset of $\text{counts}_{16}/2$ is added to the TLM data. To convert these values into voltages, the following algorithm has to be applied:

$$U(T) = (TLM \text{ data} + \text{counts}_{16}/2) * \text{Nominal_Factor} + U_{\min} \text{ [V]}$$

The calibrated temperatures can be derived from these voltages by application of a 3rd order calibration polynomial:

$$T = T_0 + T_1 * U(T) + T_2 * U(T) * U(T) + T_3 * U(T) * U(T) * U(T)$$

The coefficients T_i are:

$$T_0 = -368.6107$$

$$T_1 = +458.4930$$

$$T_2 = -356.0289$$

$$T_3 = +180.0064$$

2.1.3 Description of the Filter – Amplitude and Phase Response

RPCMAG comprises an analog fluxgate magnetometer and measures time series of the magnetic field vector. Prior to the digitalization with 20 bit ADCs the analog signal has to pass an analog lowpass-filter in order to eliminate any aliasing effects possibly occurring during the digitalization. This lowpass is a 3rd order Bessel-type filter with a corner frequency of 25 Hz. The filtered and digitized data are then sent to the PIU. As the digitization is always done with 20 Hz sampling frequency, all MAG output data are magnetic field vectors with a vector rate of 20 Hz.

The data are received by the PIU and further processed. A schematic overview about the processing is presented in the following diagram:

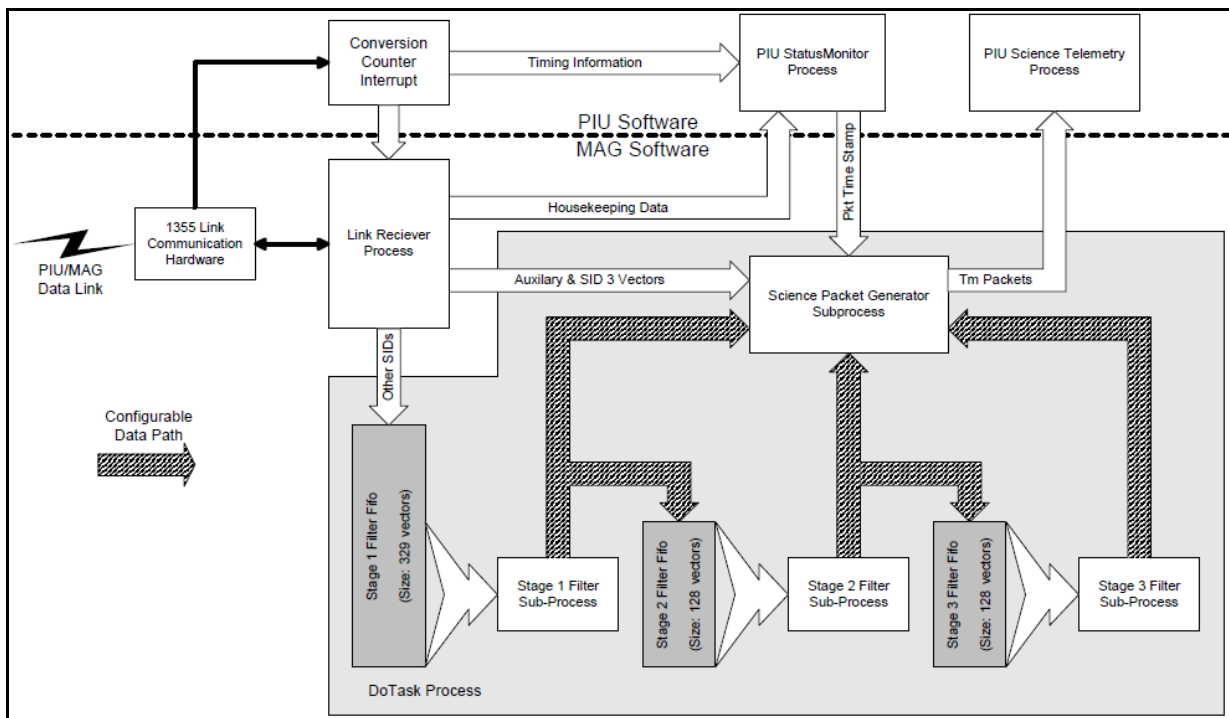

Simplified diagram of PIU data processing & data flow

The details of the PIU processing are presented in Lee, Chris: RO-RPC-MAG-6007, PIU Magnetometer Processing Software, Imperial College, London, 2005. All facts concerning the PIU which are listed here are taken from that document.

Each Telemetry packet of MAG data is marked with the conversion time of the first vector used in the calculation of the first result in the science telemetry packet. The time is generated when the PIU receives the conversion signal sent by the MAG electronics for the relevant vector. The latency time between the MAG conversion and the receipt of the conversion signal at the PIU should be added to this time.

For all data products apart from burst mode the data is passed through up to 3 stages of a symmetric digital filter (FIR) and decimated. Depending on the actual mode (SID) the specific filters (identified by a specific filter ID) are activated at each stage to provide the desired overall characteristics defined by the effective sample rate, the desired frequency & phase behavior and the cut-off frequency. Each filter is calculated from an odd number of filter coefficients which is symmetric around the centre coefficient. It is assumed that the time of a result is the time of the sample which is multiplied with this centre coefficient.

To reduce the storage and the processing the coefficients are folded around the centre coefficient so that the actual number of coefficients stored for a given filter is $(\text{No of coefficients for whole filter}+1)/2$. The Figure below illustrates the relative timing between the samples of each filter stage. It can be seen that it is dependent both on the number of coefficients (N) the filter has and the decimation interval (D) for each stage as defined by the variables "CoefficientsNo" and "DecimationInterval" in the filter header. It can be seen that the number of samples between the receipt of the latest vector and that of the vector directly relating to the time of the result is given by:

$$n = (N_3 - 1) \cdot D_2 \cdot D_1 + (N_2 - 1) \cdot D_1 + N_1$$

If the filter stage is off the value of N is 1. Results for the default set of vectors is given below. For the secondary vectors the time of the vector in a non burst mode relative to the packet time is given by $(\text{number of primary results} \cdot D_3 \cdot D_2 \cdot D_1 - 1) \cdot 0.05 \text{ sec}$

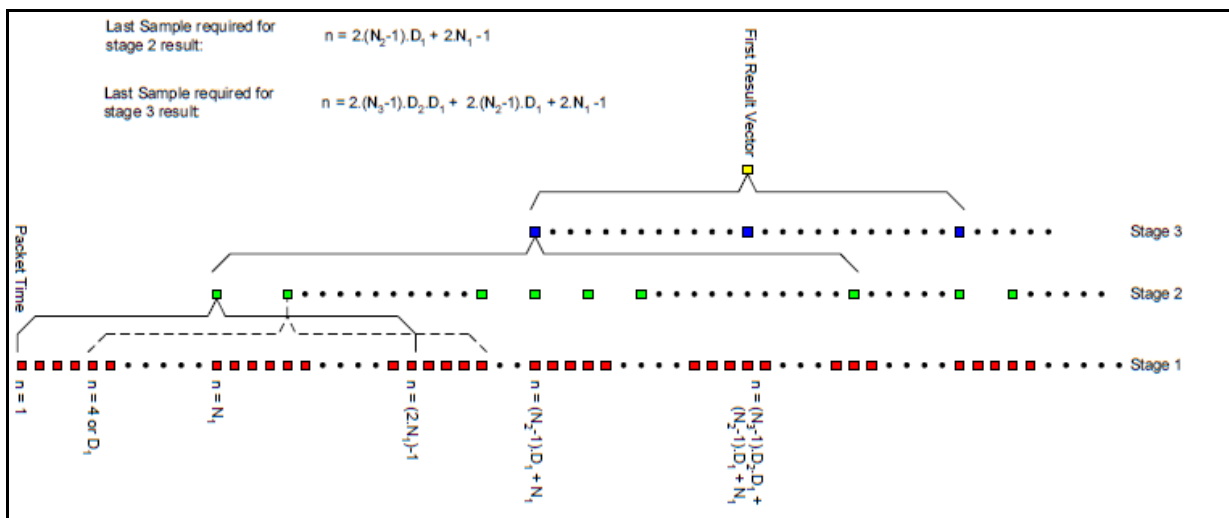

Diagram of the timing between samples in each filter level

The following table presents the details about this design for each mode:

SID No.	Name	Rate (Hz)	Filter Id's			Samples per packet	
			Stage 1	Stage 2	Stage 3	Primary	Secondary
1	Minimum	1/32	4	3	3	32	1
2	Norm	1	1	2	Off	32	1
3	Burst	20	Off	Off	Off	320	16
4	Medium	5	2	Off	Off	160	1
5	Low	1/4	4	3	Off	32	1

Definitions of each Science mode (SID) including application of specific filters

The default filters were designed to give no aliasing to any decimation given that the maximum amplitude of the signal was 2^{19} counts. This means that an attenuation of at least -114 dB is required at the Nyquist point. All filters have linear phase so that no distortion will be seen.

The following figures show in the upper panel the filter responses calculated from coefficients in real numbers (blue) and the actual response from the integer coefficients (red) used by the software. The design goal is displayed in green. In the middle panels the actual phase response is plotted. The steps in the phase function at higher frequencies do not cause any problem as they occur far beyond the cut-off frequency where the signal is already damped by at least -130dB.

The third panels finally show the derived group delay of each filter stage, derived from the phase behaviour as $\tau_{\text{group}} = -d\phi/d\omega$. As the filters are characterized by linear phase responses they show of course a constant time delay. Only at the singular frequencies where the phase jumps, singular jumps in the time delay can be seen, which do, however, not influence the filter as this happens only in the stop band of the filter.

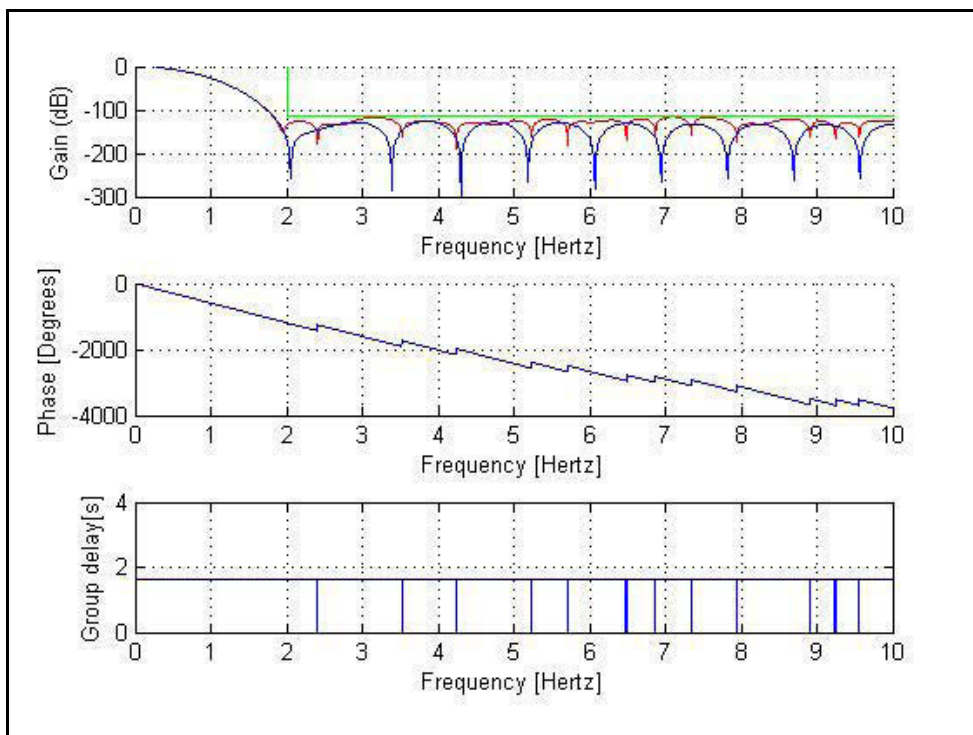

Amplitude, Phase Response and Group Delay of the Digital Filter for Filter-ID 1.

Cutoff frequency = 2Hz, Decimation 5:1, Group delay = 1.65 s

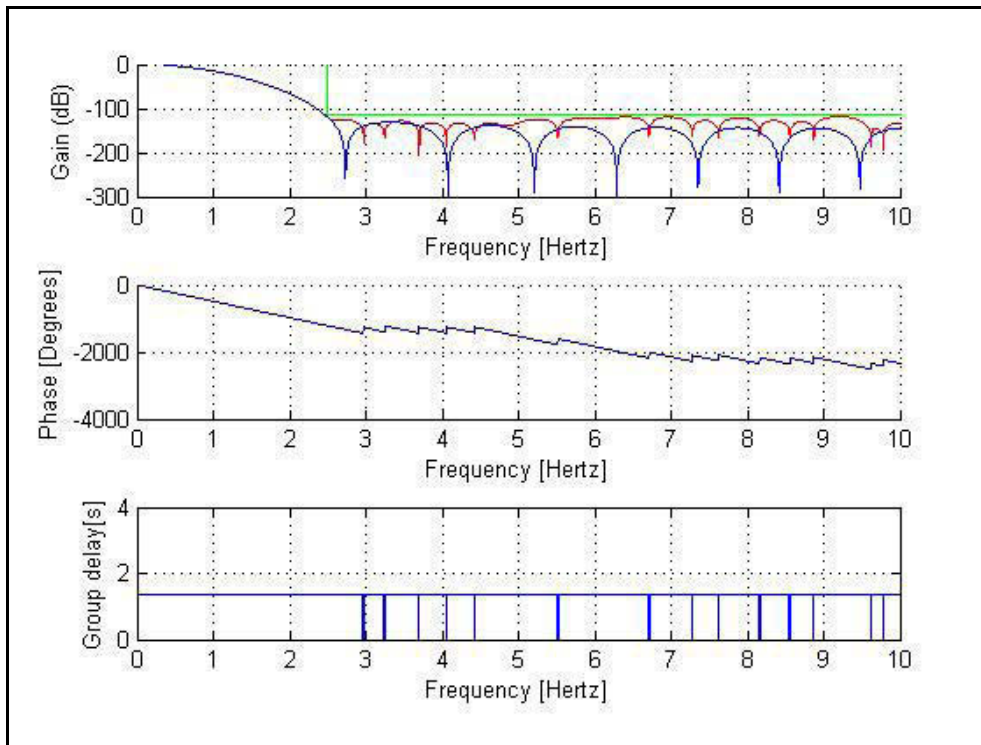

Amplitude, Phase Response and Group Delay of the Digital Filter for Filter-ID 2.
 Cutoff frequency = 2.5Hz, Decimation 4:1, Group delay = 1.35 s

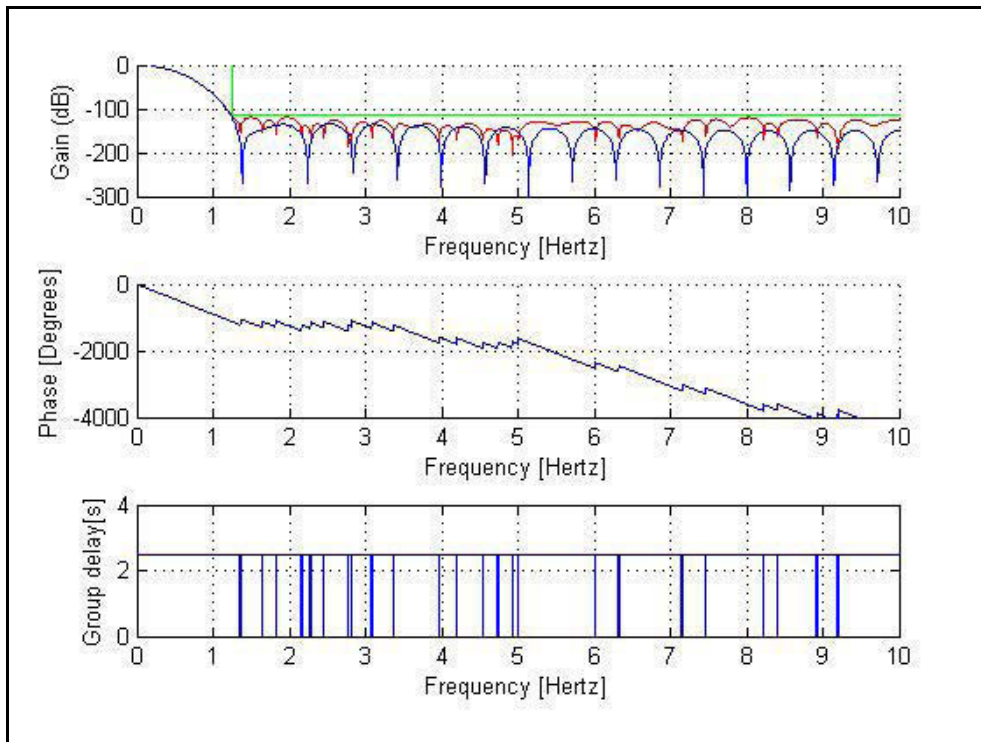

Amplitude, Phase Response and Group Delay of the Digital Filter for Filter-ID 3.
 Cutoff frequency = 1.25Hz, Decimation 8:1, Group delay = 2.5 s

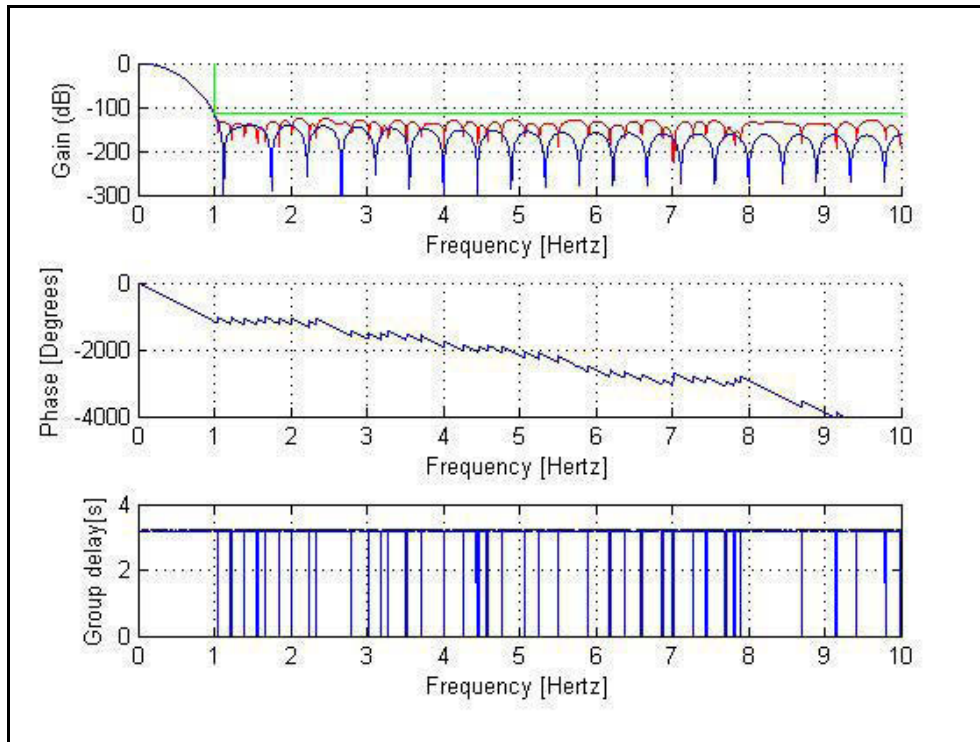

**Amplitude, Phase Response and Group Delay of the Digital Filter for Filter-ID 4.
Cutoff frequency = 1Hz, Decimation 10:1, Group delay = 3.2 s**

2.2 Overview of Data Products

RPCMAG will only deliver Flight data to the PSA. Data of the Ground calibration and the system tests cannot be converted to PDS compliant format and will be stored directly at IGEP. Relevant documentation will also be saved in the ROSETTA Knowledge Management System (ROKSY).

No software will be archived at the PSA.

2.2.1 Instrument Calibrations

The calibration for RPC-MAG has been performed completely. This means every electronics unit (DPU:FS,DPU:FM) has been calibrated connected with each sensor (Outboard sensor FS & FM, Inboard sensor FS & FM). Thus the results of all calibrations and cross calibrations will be archived.

Only the results are archived in PDS. These are

- Temperature dependent Sensitivity-Matrices
- Temperature dependent Alignment-Matrices
- Temperature dependent Offsets-Matrices
- Frequency behavior

During the calibration and integration of the instrument it turned out, that there were slight differences between the Flight model (FM) and Flight spare unit (FS) of the instruments. We choose the best one for the real flying units. These are:

- DPU: FS
- IB-Sensor: FM
- OB-Sensor: FM

2.2.2 In-Flight Data Products

Sensor temperatures of the MAG inboard and outboard sensors are delivered in the raw data files.

From the DDS we get raw data in instrument coordinates. These will be rotated into s/c-coordinates, the ground calibration parameters will be applied, and a temperature correction will be performed. The result of this procedure will be calibrated data.

On a higher level we will rotate these data in a convenient celestial body frame (e.g. EME2000, ECLIPJ2000, CSO, ...) and average these data to a convenient rate (e.g. 1s mean). A degapping and despiking filter can be applied.

The principal structure of the data products is the same for all mission phases. We will deliver ASCII tables containing at least 3 component magnetic field data and the related times in UTC and OBT. The raw data files will contain the sensor temperatures as well, as these are needed to calculate the real magnetic field.

The term "Calibrated data" means that the results of the Ground calibration will be applied to the raw data. The spacecraft generated residual fields and the structures arising from the s/c noise are NOT removed in these data.

The elimination of these effects is under development and will lead to derived data products (TBD).

A major success in improving the data quality has been achieved by creating a Reaction Wheel frequency elimination algorithm. The rotation frequencies of ROSETTA's 4 reaction wheels can be identified as disturbance spectral lines in the dynamic spectra of the MAG data. Therefore, a frequency elimination filter (dynamic sharp notch filter) had to be developed to get rid of the reaction wheel impact. The filter works satisfactory, especially for the burst data. A quite similar filter also purges the data from the LAP disturbances, which occurred as constant frequency lines (mode dependent) in the dynamic spectrum.

During the Earth Swing by it turned out that the Lander heater currents disturb the RPCMAG data. The disturbance is in the order of a nanotesla. The elimination of this disturbance is done semi manually but the generation of the archive files can be done automatically using DDS2PDS.

All higher level data products (CALIBRATED, RESAMPLED, DERIVED) contain quality flags for each magnetic field vector.

During the analysis of the EAR1 data and the comparison of the measured data with the Earth Magnetic Field model data (POMME model from GFZ ,Potsdam) it turned out that the time stamp of the measured and filtered data has to be shifted slightly due to the filter algorithm used in the PIU software. If the time stamp is uncorrected, as it is for all the data products for the phases CVP, EAR1, and CR2 level V1.0, the time of the data is a little bit to early. This means that a certain dt (s. tables) has to be added to the time stamp to get the right times. This additional time offset is mode dependent and also dependent on the actual primary / secondary sensor.

For the data of the PRIMARY sensor, which is usually the OB sensor, the following table shows the times to be added to the time stamp of the vector to get the real physical event time:

SID	Mode Name	Packet Length [s]	Time to add to PRIMARY data timestamp [s]
SID1	Minimum	1024	223.7
SID2	Normal	32	8.2 ¹
SID3	Burst	16	0
SID4	Medium	32	1.35
SID5	Low	128	27.7
SID6	Test	16	0

For the SECONDARY vectors the situation is different as these vectors are not filtered but just picked out of the data stream. The following table applies for the time shift of the SECONDARY vectors.

SID	Mode Name	Packet Length [s]	Time to add to SECONDARY data timestamp [s]
SID1	Minimum	1024	1023.95

¹ The analysis of the Earth Fly-by data resulted in a time shift of 8.3s. The stated 8.2 s is a theoretical value derived from the digital filter design.

SID2	Normal	32	31.95
SID3	Burst	16	15.95
SID4	Medium	32	31.95
SID5	Low	128	127.95

For the later data products, starting with MARS or delivery level higher than V1.0 these corrections will be taken into account automatically by the Archive generation software. The correction is done only for the CALIBRATED, RESAMPLED and DERIVED science data, neither for EDITED data nor for HOUSEKEEPING data. Only the UTC time stamps are changed, the OBT is kept in the originally state to maintain a reference to the original TLM data.

All the data processing performed by the analysis software is done on the base of the UTC timestamps. The OBT is never used during the calibration or analysis.

Data products:

EDITED RAW DATA: Data in ADC Counts

- Housekeeping Data
UTC, OBT, T_OB, T_IB, STAGE_ID_A, STAGE_ID_B, FILTER_CFG, MAG_REF_VOLT,
MAG_NEG_VOLT, MAG_POS_VOLT, BX_OB, BY_OB, BZ_OB
- IB & OB Data
UTC, OBT, BX, BY, BZ, T, QUALITY

CALIBRATED DATA: DATA in Physical units, bad vectors removed, Quality flagged

LEVEL_A Data:

- Housekeeping Data
UTC, OBT, T_OB, T_IB, STAGE_ID_A, STAGE_ID_B, FILTER_CFG, MAG_REF_VOLT,
MAG_NEG_VOLT, MAG_POS_VOLT, BX_OB, BY_OB, BZ_OB
- IB & OB Data in Instrument coordinates
UTC, OBT, BX, BY, BZ, T, QUALITY

LEVEL_B Data:

- IB & OB Data in s/c coordinates
UTC, OBT, BX, BY, BZ, T, QUALITY

LEVEL_C Data:

- IB & OB Data in Celestial body coordinate system, e.g. ECLIPJ2000
UTC, OBT, POS_X, POS_Y, POS_Z, BX, BY, BZ, QUALITY

RESAMPLED DATA : DATA in Physical units, bad vectors removed, Quality flagged

LEVEL_K Data:

- IB & OB Data in s/c coordinates, Lander Heater influence eliminated
Source is corrected LEVEL_B data
UTC, OBT, BX, BY, BZ, T, QUALITY

LEVEL_L Data:

- IB & OB Data in Celestial body coordinate system, e.g. ECLIPJ2000
Source is corrected LEVEL_C data
UTC, OBT, POS_X, POS_Y, POS_Z, BX, BY, BZ, QUALITY

LEVEL_E Data:

- IB & OB Data in Instrument coordinates, derived from LEVEL_A data, data resampled to specified average interval, e.g. 1s, or 1 min
UTC, OBT, BX, BY, BZ, T, QUALITY

LEVEL_F Data:

- IB & OB Data in s/c - coordinates, derived from LEVEL_B or LEVEL_K data, data resampled to specified average interval, e.g. 1s, or 1 min
UTC, OBT, BX, BY, BZ, T, QUALITY

LEVEL_G Data:

- IB & OB Data in Celestial body coordinate system, e.g. ECLIPJ2000, derived from LEVEL_C or LEVEL_L data, data resampled to specified average interval, e.g. 1s, or 1 min
UTC, OBT, POS_X, POS_Y, POS_Z, BX, BY, BZ, QUALITY

LEVEL_H Data: Reaction Wheel Corrected Data

- IB & OB Data in Celestial body coordinate system, e.g. ECLIPJ2000, derived from LEVEL_C or LEVEL_L data, reaction wheel influence eliminated by filtering in frequency domain.
UTC, OBT, POS_X, POS_Y, POS_Z, BX, BY, BZ, QUALITY

LEVEL_I Data: Reaction Wheel Corrected Data, Averaged

- IB & OB Data in Celestial body coordinate system, e.g. ECLIPJ2000, derived from LEVEL_H data, reaction wheel influence eliminated by filtering in frequency domain, data resampled to specified average interval, e.g. 1s, or 1 min
UTC, OBT, POS_X, POS_Y, POS_Z, BX, BY, BZ, QUALITY

DERIVED DATA (occasionally): DATA in Physical units, bad vectors removed

LEVEL_J Data: PCA processed data

- IB & OB Data derived from LEVEL_G, LEVEL_H or LEVEL_J data, a principal component analysis (PCA) has been applied, output is
 - One file for correlated data (_C), and
 - Two files (IB, OB) containing uncorrelated data (_U)
 - UTC, OBT, POS_X, POS_Y, POS_Z, BX,BY,BZ, QUALITY

Normally EDITED RAW DATA, CLA, CLB, CLC, CLF and CLG data will be produced, in case of heater problems additionally CLK and CLL data will be available. In case of Reaction wheel or LAP disturbance also CLH data will be generated.

The following figure shows an overview about the relation of all produced data types:

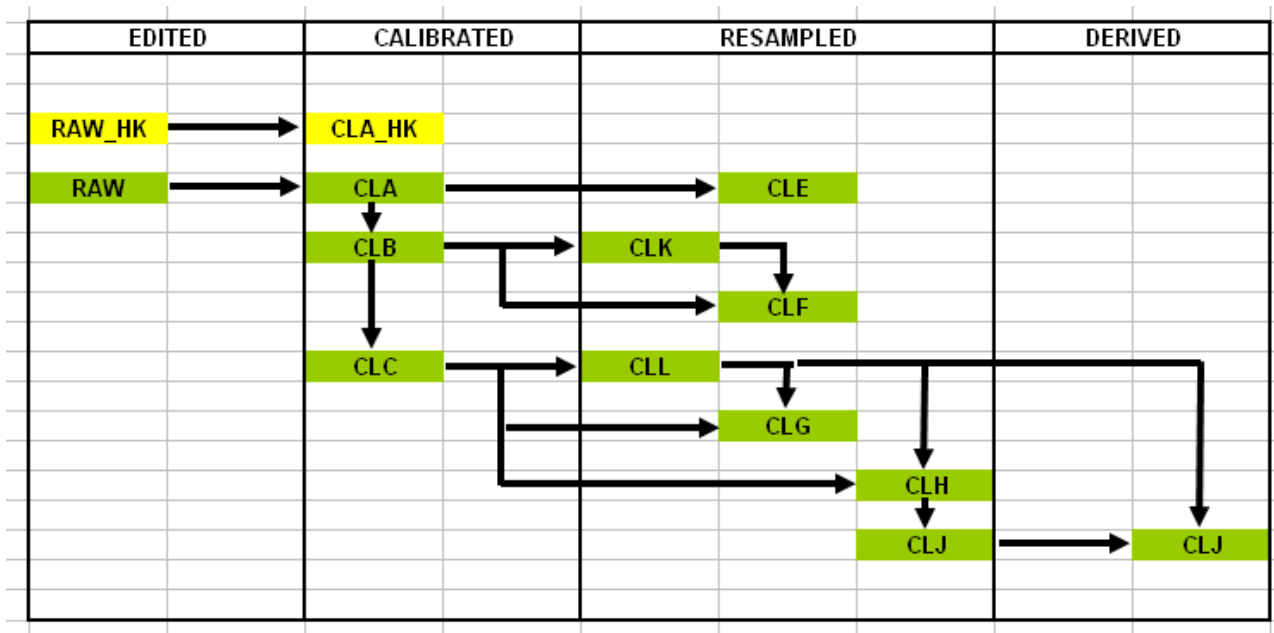

DATA PRODUCT OVERVIEW

2.2.3 Software

We do not deliver any software.

2.2.3.1 Calibration Software

The ground calibration s/w is a complex package of different routines which has been used since many years for many missions (e.g. CLUSTER, DS-1, CASSINI, ...). The s/w is stored at the IGEP.

A single binary calibration file (*.CCD, Complete Calibration Data) produced by the calibration facility contains all information needed to perform a specific calibration task like offset determination or calculation of sensitivity and alignment. The calibration analysis s/w extracts the needed frames like applied magnetic field of the coil facility, measured fields of the FGM under test, and the actual temperatures. Then an appropriate sensor model will be applied to the data (e.g. linear model or models of higher order) to calculate the temperature dependent sensor parameters like offset, alignment and sensitivity. The frequency behavior will be investigated as well.

At the end of the process a report is written containing all results needed to use the magnetometer. All necessary parameters are written to the result files which are read by the DDS2PDS S/W.

DDS2PDS will apply the ground calibration results and additionally inflight calibration parameter to the data to generate proper archive data. In case of disturbance by ROSETTA's reaction wheels special filters in the frequency domain can be applied to get rid of the reaction wheel frequencies in the magnetic field data. This can be done automatically if needed. This elimination requires the knowledge of the reaction wheel frequencies which have to be retrieved from the DDS prior to the analysis.

Also the Lander heater currents have an influence to the magnetic field data. This impact can be eliminated semi manually by comparing Lander HK data, ROMAP signatures and the RPCMAG data. The used s/w is not part of the DDS2PDS package.

It is a known fact that the magnetic field sensors are very temperature sensitive. This behavior has been calibrated at the ground calibration down to -60°C . In flight, however, lower temperatures are seen. It turned out that the extrapolation of the ground calibration results (only the temperature dependent offset shift) did not lead to really convincing results. Therefore inflight data were taken to create a new temperature model of the offset behavior. For the early mission phases a common model, based on CVP & EAR1 data was used – the so called model 002. During the Mars swing by it turned out that the usage of a model based on daily changes yields to even better results. Especially due to hysteretic effects (in terms of temperature influence) of the magnetic field sensor it showed up that a more sophisticated temperature model was needed

Therefore the CALIB_ROS_TEMP_XXXX and the GEN_CAL_DATA S/W (IDL) were improved/extended to handle this more complex task, leading to model 006. Also the method was changed. The model 002 was achieved by calculating a best fit 3rd order polynomial of the sensor temperatures to the magnetic field (one polynomial for each of the 6 sensor components).

For the calculation of the new model 006 a different approach based on the following items, has been chosen:

- The correlation of the OB magnetic field readings and the OB temperature has to be minimal.
- The correlation of the IB magnetic field readings and the IB temperature has to be minimal.
- The correlation of the IB magnetic field readings and the OB magnetic field readings has to be maximal.
- The influence of the temperature can be eliminated (minimized) by subtracting suitable polynomials $P(T)$ from the magnetic field readings.
- The coefficients of these 6 polynomials are calculated from the optimization of the 9 above mentioned correlation coefficients.

Mathematically this is done by a POWELL minimization routine.

It showed up that the best result is achieved if this calculation is done day by day in order to really take the right temperature behavior into account. The former temperature model showed significantly worse results especially at lower temperatures and faster temperature changes. The calculated polynomials can be of 5th

order, but the analysis yielded that linear ones with only very little quadratic and cubic contribution are the best ones. All the MARS data and future data will be calibrated using this new model.

2.2.3.2 Pipeline processing Software

The pipeline processing s/w is named DDS2PDS. A coarse overview has been given already in chapter 2.2. DDS2PDS can be used with a command file in batch mode. Thus, data of many days can be processed automatically. The output of DDS2PDS are PDS files sorted by modes and times and calibration levels. Usually there will be one file per day and mode and level. CLH, CLK, and CLL file are generated only if disturbances occur and if they can be eliminated.

The format and the content of all PDS *.TAB files is stated in chapter 2.4.5.

2.2.3.3 Scientific analysis Software

The DDS2PDS software has also the capability to generate different kinds of plots. Thus time series can be plotted for every calibrated data level. Additionally spectra plots can be generated as well as plots of the differences of the OB & IB sensor.

Higher Level analysis software is currently under development.

2.2.4 Documentation

The features of the DDS2PDS s/w package are described in detail in the

DDS2PDS User Manual, RO-IGEP-TR0007.

This manual is not anymore part of the documentation package, because a reviewer did not find it very useful to deliver this documentation. Also the S/W will not be delivered to the archive.

2.2.5 Derived and other Data Products

Actually it is not planned to deliver other derived data products than the described ones in section 2.4.5.

2.2.6 Ancillary Data Usage

For calculation of the magnetic field in a celestial reference coordinate system it is essential to have information about the attitude of the s/c and the position of the s/c. These data have to be available on the DDS.

Without these ancillary data (ATNR, ORER, ORHR,...) the generation of LEVEL_C (or higher level) data is not possible. The files can be retrieved from the AUXILIARY data section of the ROSETTA DDS. The format and content of these files is described in the ROSETTA DDID RO-ESC-IF-5003.

The Attitude information is extracted from the actual ATNR file. Currently this is ATNR_FDLRMA_DAP040302093352_0053.ROS. This ASCII file is provided by ESOC/TOS-GFI and contains ROSETTA'S state attitude quaternions. The actual attitude can be evaluated using the OASW S/W provided by ESOC.

The positions of the s/c are retrieved from the ORxx files. All positions are given here in the EME2000 frame. The coordinate systems centers, however, are different:

FILE	COORDINATE SYSTEM CENTER
ORHR	SUN
ORER, ORFR, ORGR	EARTH
ORMR	MARS

These ASCII file are provided by ESOC/TOS-GFI as well and contain ROSETTA'S state vectors (positions & velocities for given times). The position for a specific time can be evaluated using the OASW S/W provided by ESOC.

Meanwhile the calibration software has been changed. For the transformation between s/c-coordinates and celestial coordinates the SPICE system, generated by the JPL NAIF group, is used. The input to the ROSETTA trajectory and attitude kernels is provided by the ESOC Flight dynamic team. All needed SPICE transformation routines are embedded in the IDL analysis software. Each single magnetic field vector is transformed time dependently in the desired way to the needed celestial coordinate system. The SPICE kernels used in the specific magnetic field data file are listed in each related *:LBL file.

3 Archive Format and Content

3.1 Format and Conventions

3.1.1 Deliveries and Archive Volume Format

PDS compliant data will be delivered to ESA on DATA SET Level. One Data Set corresponds to one Volume.

Data of different Processing Levels will be archived in different Data Sets.

The complete RPCMAG Data Set will be delivered to the Imperial College server. From here all RPC data will be delivered to ESA by the RPC Archive Manager.

3.1.2 Data Set ID Formation

Example: DATA_SET_ID = "RO-X-RPCMAG-3-CVP-RAW-V3.0"

The Data Set Id has the following structure

- RO: Rosetta Orbiter as instrument host
- <target_Id> :
 - E: Earth,
 - A: Asteroid
 - M:Mars
 - C:Comet
 - X: Checkout
 - CAL:Calibration
 - SS:SOLAR WIND
 - D: Dust
- RPCMAG: Magnetometer Instrument
- <data_Processing_level> : Codmac Level 1...8,N .

According to PDS Standard Reference, Chapter 6.5
- <Mission Phase abbreviation>:
 - CVP: Commissioning
 - EAR1,EAR2,EAR3 : Earth Swing-By
 - CR1...CRn : Cruise Phases
 - MARS
 - AST1,AST2 : Asteroid Fly-by

- RVM1,RVM2 : Rendezvous Manoeuvre
- NCD : Near comet Drift
- FAT / CAT: Far / Close Approach Trajectory
- TGM : Transition to Global mapping
- GMP: Global mapping Phase
- COP : Close Observation Phase
- SSP : Lander delivery
- LOW / HIGH :Comet Activity low/ high
- MINC: Comet Activity moderate increase
- SINC: Comet Activity sharp increase
- PERI : Near Perihelion
- EXT: Extended Mission

Accumulated Phases:

- APPR : Approach FAT to COP
- ESCO : Escort LOW to PERI
- COM : Comet FAT to PERI

Designators according to RO-EST-PL-5011, Table 2

- Description: processing level...
- V3.0 version number

3.1.3 Data Directory Naming Convention

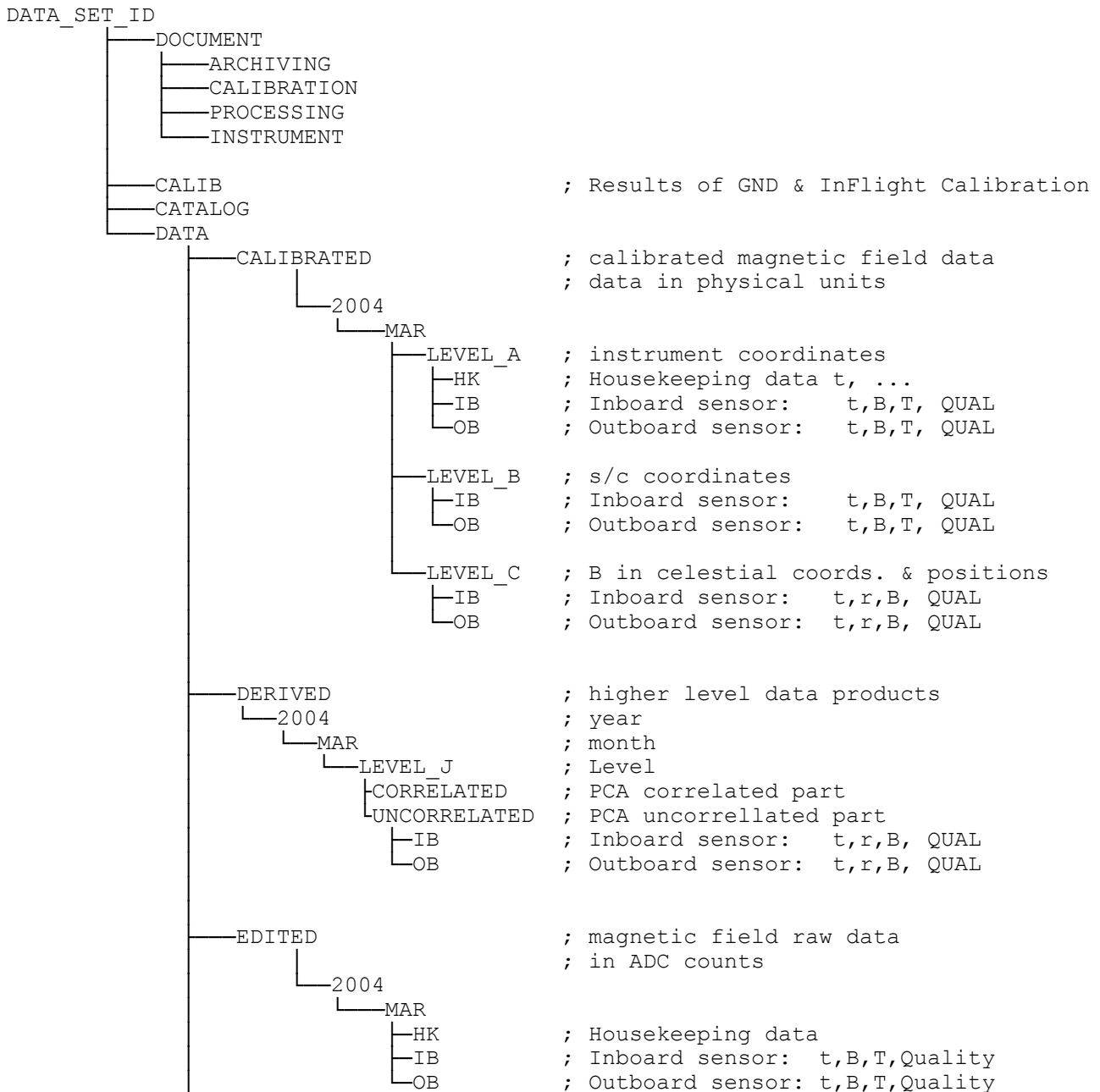

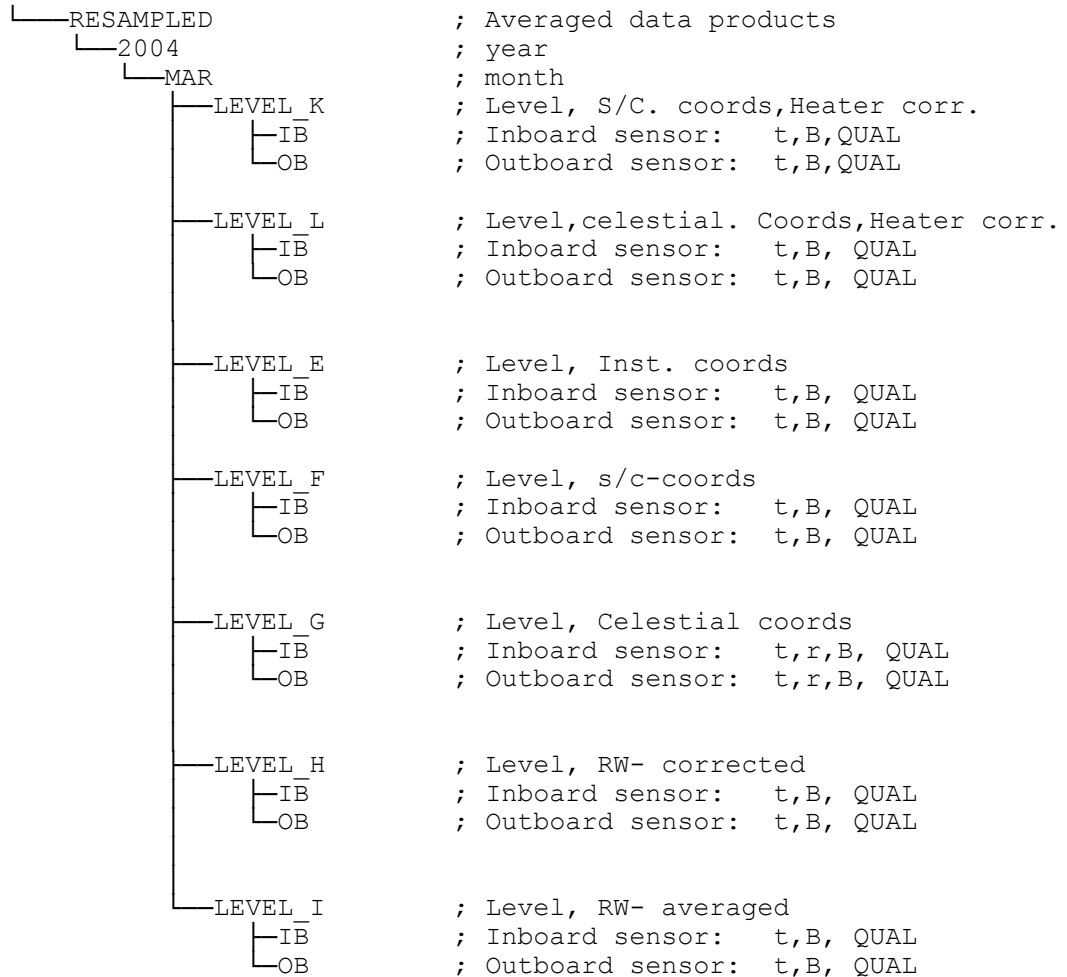

This directory shows the complete internal data structure, which gives an detailed overview of all processed data. When the data will be delivered to the PSA, the transmitted structure will be adapted in that way, that only the data of a single processing level (EDITED, CALIBRATED, RESAMPLED,...) will go into the designated data set. There are no empty folders . Data of different processing levels will go to different data sets.

For every activated mode there will be one single file for each day where data have been measured. This means that there can be data gaps in the file if e.g. there were some measurements in the morning and some others in the evening.

3.1.4 Filenaming Convention

Magnetic Field data filename convention for EDITED and CALIBRATED data:

```
<inst> <begin of observation>_<level>_<sensor>_<inst mode>.<ext>
RPCMAG yymmddThhmm RAW IB M1..M6 LBL
          CLA OB TAB
          CLB
          CLC
```

Example: RPCMAG040528T1230_CLC_OB_M3.LBL
RPCMAG040528T1230_CLC_OB_M3.TAB

Magnetic Field data filename convention for RESAMPLED averaged data (CLE,CLF,CLG,CLI):

```
<inst> <begin of observation>_<level>_<sensor>_A<average>.<ext>
RPCMAG yymmdd CLE IB A60 LBL
          CLF OB TAB
          CLG
          CLI
```

Example: RPCMAG040528_CLG_OB_A20.LBL
RPCMAG040528_CLG_OB_A20.TAB

Average denotes the time interval for one average period in seconds.

Magnetic Field data filename convention for RESAMPLED Heater or Reaction Wheel influenced data (CLK, CLL, CLH):

```
<inst> <begin of observation>_<level>_<sensor>_<inst mode>.<ext>
RPCMAG yymmddThhmm CLK IB M1..M6 LBL
          CLL OB TAB
          CLI
```

Example: RPCMAG040528T1230_CLK_OB_M3.LBL
RPCMAG040528T1230_CLK_OB_M3.TAB

Magnetic Field data filename convention for PCA corrected data:

Correlated data:

<inst> <begin of observation>_<level>_A<average>_C.<ext>
 RPCMAG yymmdd CLJ A60 LBL
 TAB

Example: RPCMAG040528_CLJ_A20_C.LBL
 RPCMAG040528_CLJ_A20_C.TAB

Average denotes the time interval for one average period in seconds.

Uncorrelated data:

<inst> <begin of observation>_<level>_<sensor>_A<average>_U.<ext>
 RPCMAG yymmdd CLJ IB A60 LBL
 CLJ OB TAB

Example: RPCMAG040528_CLJ_OB_A20_U.LBL
 RPCMAG040528_CLJ_OB_A20_U.TAB
 RPCMAG040528_CLJ_IB_A20_U.LBL
 RPCMAG040528_CLJ_IB_A20_U.TAB

Average denotes the time interval for one average period in seconds.

Housekeeping data Convention:

<inst> <begin of observation>_<datatype>.<ext>
 RPCMAG yymmddThhmm _ HK LBL
 TAB

Example: RPCMAG040528T1230_HK.LBL
 RPCMAG040528T1230_HK.TAB

3.2 Standards Used in Data Product Generation

3.2.1 PDS Standards

MAG complies to PDS version 3, and we use version 3.6 of the PDS standard reference.

3.2.2 Time Standards

The Time Standard used for RPC-MAG obey the definitions stated in
Rosetta Time Handling, RO-EST-TN-3165, sect. 4.2

UTC Time Format :

Time(UTC) in LBL files: yyyy-mm-ddThh:mm:ss.sss

Time(UTC) in TAB files: yyyy-mm-ddThh:mm:ss.ssssss

ss.sss means: "seconds . decimal fractional seconds"

OBT Time Format:

The PDS keywords

SPACECRAFT_CLOCK_START_COUNT and
SPACECRAFT_CLOCK_STOP_COUNT
refer to OBT.

The header of the experiment telemetry source packets contains the data acquisition start time in OBT as 32 bit of unit seconds followed by 16 bit of fractional seconds. OBT = 0 is at 2003-01-01-T00:00:00 UTC. The time resolution is $2^{(-16)} = 1.53E-5$ seconds. The OBT is represented in the following format:

SPACECRAFT_CLOCK_START/STOP_COUNT = "<reset number>/<unit seconds>.<fractional seconds>"

The unit seconds and the fractional seconds are separated by the full stop character ("."). Note that this is not a decimal point. The fractional seconds are expressed as multiples of $2^{(-16)} = 1.53E-5$ seconds and count from 0 to $2^{16} - 1 = 65535$.

E.g. in SPACECRAFT_CLOCK_START_COUNT = "1/21983325.392" the 392 fractional seconds correspond to $392 * 2^{(-16)} = 0.00598$ decimal seconds.

The spacecraft clock could be reset during the mission (although this is not planned). This would imply a change of the zero point. The zero point of the OBT will be indicated by pre-pending the reset number (integer starting at 1) and a slash to the unit seconds, i.e. "1/" means OBT = 0 at 2003-01-01T00:00:00 UTC.

Spacecraft Clock (OBT) in LBL files: "r/nnnnnnnnnn.nnnnn"

Spacecraft Clock (OBT) in TAB files: nnnnnnnnnn.nnnnn

Here r means the reset number starting at 1. As the OBT is in the TAB files is supposed to be just an add-on information only the value of the clock without the reset number is stored. Probably nobody will use the OBT inside the TAB files as UTC is available for a comparison with other data.

3.2.3 Reference Systems

System Name	Definition
Instrument coordinates	RPC-MAG unit reference systems for the Inboard (IB) and Outboard (OB) sensor. Systems are defined relative to the S/C coordinate system using matrices for the stowed and deployed boom orientations. The matrices can be found in the ./calib/RPCMAG_SC_ALIGN.TXT file, distributed with each CALIBRATED and RESAMPLED dataset.
S/C coordinates	Orientation: x: pointing from the LANDER to the s/c center, perpendicular to solar array axes; y:parallel to solar array axis; pointing to the left, when standing in front of the Lander, z: pointing up
EME2000	Earth Mean Equator inertial reference frame related to Equinox of Epoch J2000. Orientation: X: Pointing from SUN to Vernal Equinox, Y: perpendicular to X in Earth Equatorial plane, Z: Perpendicular to Earth Equatorial plane, pointing up
ECLIPJ2000	Ecliptic Coordinates related to Equinox of Epoch J2000. Orientation: X: Pointing from SUN to Vernal Equinox, Y: perpendicular to X in Ecliptic Plane, Z: Perpendicular to Ecliptic plane, pointing up
CSO	Comet Centric Solar Orbital System. Orientation: X: Pointing from COMET to SUN, Y: The inertially referenced velocity of the sun relative to the comet is the secondary vector: the Y axis is the component of this velocity vector orthogonal to the X axis. Z: Perpendicular to X and Y, completing system to be right handed

GSE	GEO Centric Solar Ecliptic System. Orientation: X: Pointing from EARTH to SUN, Y: perpendicular to X in Ecliptic plane, Z: Perpendicular to Ecliptic plane, pointing up
MSO	Mars Centric Solar Orbital System. Orientation: X: Pointing from MARS to SUN, Y: perpendicular to X against planetary motion, Z: Perpendicular to X & Y, completing system to be right handed
CSEQ	Body-centered Solar EQUatorial This frame is defined as a two-vector style dynamic frame as follows: +X axis is the position of the Sun relative to the body; it's the primary vector and points from the body to the Sun; +Z axis is the component of the Sun's north pole of date orthogonal to the +X axis; +Y axis completes the right-handed reference frame; The origin of this frame is the body's center of mass.

3.2.4 Other Applicable Standards

N/A

3.3 Data Validation

For the validation of the data, data of the OB and IB sensor will be compared. They should show similar structures, originated in the solar wind. Due to the distortions of the s/c, however, there will be uncorrelated structures as well. The temperatures of both sensors should be nearly identical. A comparison of the MAG data with the data of the Lander magnetometer ROMAP will reveal precious information.

For a more quantitative assessment quality flags have been implemented to each magnetic field vector stored in TAB file. The quality flag is a string of 8 digits. The definition of this flag system is given in the following table

```
# ROSETTA RPCMAG QUALITY INDEX FILE FOR LUTETIA
# IR 18. 06.2012
# Speichern als MS_DOS *.TXT file
#
# FLAG-STRING FLAG DESCRIPTION
# 87654321
# .....----- 1 IMPACT OF REACTION WHEELS
# .....      x = impact not assessed
# .....      0 = no disturbance
```

- # 1 = disturbance eliminated during data analysis
..... 2 = disturbance elimination failed
..... 3 = data disturbed
.....
.....----- 2 IMPACT OF LANDER HEATER CURRENTS:
..... x = impact not assessed
..... 0 = no disturbance
..... 1 = disturbance eliminated during data analysis
..... 2 = disturbance elimination failed
..... 3 = data disturbed
.....
.....----- 3 BOOM DEPLOYMENT:
..... 0 = boom deployed
..... 1 = boom stowed
..... 2 = boom deployment ongoing. Data only valid in instrument coordinates
..... 3 = pyros fired for boom release
.....
.....----- 4 OFFSET/RESIDUAL-FIELD RELATED EFFECTS:
..... x = offset/residual-field issues not assessed
..... 0 = no offset/residual-field problems
..... 1 = offset/residual-field behavior not clear
..... 2 = offset drifts, sensor not in thermal equilibrium thus temperature model N/A
..... 3 = offset/residual-field drifts, reason unknown
..... 4 = residual-field jump detected, reason unknown
.....
.....----- 5 CORRELATION BETWEEN IB AND OB SENSOR
..... x = correlation not assessed
..... 0 = perfect correlation
..... 1 = good correlation
..... 2 = poor correlation
..... 3 = IB and OB show different long term behavior
.....
.....
.....----- 6 OTHER IMPACTS DECREASING THE QUALITY
..... x = no assessment
..... 0 = no other problems detected
..... 1 =
..... 2 =
..... 3 =
..... 4 = data disturbed by pulses originated in s/c
..... 5 = data disturbed by AC signal originated in s/c
..... 6 = data noisy due to power on failure
..... 7 = data not calculatable due to thermistor failure
..... 8 = sensor saturated due to huge external field
..... 9 = sensor saturated, instrument power on sequence failed
.....
.....----- 7 TBD
..... x = no assessment
.....----- 8 TBD
..... x = no assessment

With this complex quality assessment system it is possible to quantify the quality of each single vector in a detailed way. It is flexible enough to be adapted to widely spread future needs.

At a first step the flags have to be determined and written to an overall time oriented index file. Each time a flag changes a new entry has to be generated. This step has to be done manually day by day. Once this index file has been generated the S/W BATCH_SET_QUALITY will read this file and pad each vector in every related TAB file with the right quality flag.

Flag evaluation Process:

Flag 1: Impact of Reaction wheels

This influence is checked by comparison of the dynamic frequency spectra of the magnetic field vectors and the spectra of the reaction wheels obtained from the DDS TM files. After calculation of the spectra the flags can easily be determined manually day by day (Optical comparison of plots: do disturbing spectral lines exist or not)

Flag 2: Impact of Lander Heater Currents

These heater currents were up to now only disturbing during EAR1. The overall switch on/off times of this disturbance can be retrieved from Lander HK data.

Flag 3: Boom Deployment

The boom has been deployed on March 19, 2004. Exact times are known.

Flag 4, 5: Offset / residual field related/ Effects & Correlation between IB and OB Sensor

The offset is temperature dependent. Although a 3rd order model of the offset's temperature dependence exists the offset can not be determined exactly at any time. Especially immediately after powering on the instrument (up to a few hours later) the thermal equilibrium is not reached and therefore the thermal model cannot be applied. This leads to arbitrary offset values.

The S/W QUALITY_CHECK performs an automatic analysis of the IB and OB sensor temperatures. It will mark the quality as bad if the magnitude of the 1st derivative of the difference of these temperatures exceeds a certain threshold.

Furthermore various kinds of magnetic field difference plots (IBi-Obi vs .Time, IBi vs.OBi) are generated to get an idea of the offset jumps. The flags will be set according to the inspection.

Flag 6: Other Impacts

Manual inspection of HK data and taking into account all known problems

Flag 7 TBD

Flag 8 TBD.

The Quality assessment is done by the data producer.

More details about the quality flag system can be found in the reports

“Overview of available RPCMAG data and quality assessment ...” delivered with each data set.

See e.g RO-IGEP-TR0035 for the mission phase “LUTETIA”.

3.4 Content

3.4.1 Volume Set

According to Planetary Data System Standard Reference, Version 3.6, Chapter 19, Figure 19.1.

3.4.2 Data Set

Our naming convention for the DATA_SET_NAME will follow the same principles as the DATA_SET_ID in chapter 3.1.3.

```
DATA_SET_NAME="ROSETTA-ORBITER <target_name> RPCMAG <level> <Mission phase  
abbreviation> <Description> <version number>"
```

<target_name> =

- 67P
- <asteroid short name>
- EARTH
- MARS
- CHECK
- CAL
- DUST
- SW

Target names according to RO-EST-PL-5011, table 4

<level> = Codmac Level 1...8,N . According to PDS Standard Reference, Chapter 6.5

<Mission Phase abbreviation> =

- CVP : Commissioning
- EAR1,EAR2,EAR3 : Earth Swing-By
- CR1...CRn : Cruise Phases
- MARS
- AST1,AST2 : Asteroid Fly-by
- RVM1,RVM2 : Rendezvous Manoeuvre
- NCD : Near comet Drift
- FAT / CAT: Far / Close Approach Trajectory
- TGM : Transition to Global mapping
- GMP: Global mapping Phase
- COP : Close Observation Phase
- SSP : Lander delivery
- LOW / HIGH :Comet Activity low/ high
- MINC: Comet Activity moderate increase
- SINC: Comet Activity sharp increase
- PERI : Near Perihelion
- EXT: Extended Mission

Accumulated Phases:

- APPR : Approach FAT to COP
- ESCO : Escort LOW to PERI
- COM : Comet FAT to PERI

Designators according to RO-EST-PL-5011, Table 2

<Description> = This contains the processing level in text form:

- EDITED
- CALIBRATED
- RESAMPLED
- DERIVED.

<Version Number>= Contains the Dataset version, e.g. V1.0

One data set will be used for each processing level. Multiple targets will be used for each data set and within each data set TARGET_NAME and TARGET_TYPE will be used to identify the current target (Thus they will not stay the same within one data set, but data set id will). The data set name fits in the full length thus 60 characters.

3.4.3 Directories

3.4.3.1 Root Directory

The root directory for the RPCMAG data is named with the DATA_SET_ID. It will only contain the **AAREADME.TXT**, the **VOLDESC.CAT** and the PDSVOLUME.XML info file.

3.4.3.2 Calibration Directory

Contains the files:

CALINFO.TXT

; Info File

RPCMAG_SC_ALIGN.TXT

; Results of the sensor to S/C coordinates alignment

After the S/C integration an optical measurement of the sensor and boom orientation has been carried out by ASTRIUM people at ESTEC. Mirrors were attached to the sensors and the exact alignment wrt. Spacecraft has been determined. The resulting angles are listed in this file for a stowed and a deployed boom.

RPCMAG_GND_CALIB_FSDPU_FMIB.TXT ; GND Calibration results of FS DPU & FM IB sensor

RPCMAG_GND_CALIB_FSDPU_FMOB.TXT; GND Calibration results of FS DPU & FM OB sensor

These two files contain the results of the ground calibration for each SENSOR/DPU combination. All temperature dependent sensitivity, misalignment and offset coefficients (refer to RO-IGM-TR0003, Analysis of the FMG Calibration, Chapters 7 & 8 & 9) are listed here to be read by the data calibration software.

During flight it turned out that the temperature model had to be extended to lower temperatures. Therefore, a new model with additional coefficients has been created. These coefficients are stored in inflight calibration files.

RPCMAG_002_CALIB_IB.TXT ; Inflight Calibration results for the IB sensor

RPCMAG_002_CALIB_OB.TXT; Inflight Calibration results for the OB sensor

These files were used for the early mission phases CVP –EAR1 – CR2.

If there should be any need for future changes/improvements of these models/coefficients the file Counter (currently 002) will be incremented and the new values are stored to new files. The calibration software has the feature to distinguish between the calibration file versions. E.g. for the MARS fly by there are inflight calibration file on daily based data:

RPCMAG_070223_006_CALIB_IB.TXT ; Inflight Calib. for the IB sensor, February 23, 2007

RPCMAG_070223_006_CALIB_OB.TXT; Inflight Calib. for the OB sensor, February 23, 2007

....

RPCMAG_070227_006_CALIB_IB.TXT ; Inflight Calib. for the IB sensor, February 27, 2007

RPCMAG_070227_006_CALIB_OB.TXT; Inflight Calib. for the OB sensor, February 27, 2007

Temperature models will be created dependent on the data behavior and s/c operations. If there are lots of attitude changes during an observation, the sensor temperature will change accordingly and the usage of

daily based calibration files will make sense. In stable phases, however, a single model for a long interval is sufficient.

In the case of using many calibration files for a single observation period, the different offsets between the models have to be adapted. This is done by the files

CLA_OFFSETS_IB.TXT ; Model Offset Correction file for the IB sensor

CLA_OFFSETS_OB.TXT ; Model Offset Correction file for the OB sensor

In these files the first and last magnetic field values of the regarded TAB file are stored. For every entry line there are 3 GND calibration based values and 3 inflight calibration based values per sensor (data are stored in Instrument coordinates). From the last value of the previous data file and the first value of the actual data file the original data jumps (GND calibration based) can be calculated. This jump height is used to set the jump height for the inflight calibration data to the same value to get rid of any artificial field jumps. The calculated offset correction (3 components per sensor) for the actual used model is written also to these files.

File format:

TIME Bx_GND By_GND Bz_GND Bx_IFL By_IFL Bz_IFL OFF_X OFF_Y OFF_Z T

Time in UTC, Magnetic field values in nanoTesla, Temperatures in Kelvin.

3.4.3.3 Catalog Directory

Contains the files:

FILENAME	DESCRIPTION
CATINFO.TXT	This file contains a list of all catalog files located in the CATALOG directory. A brief description of these files is given
DATASET.CAT	This file describes the MAGNETOMETER dataset in the actual mission phase
ROSETTA_INSTHOST.CAT	This file describes the ROSETTA s/c acting as instrument host for all the experiments. This file was provided by ESA.
ROSETTA_MISSION.CAT	This file describes the ROSETTA mission to Comet 67P/Churyumov-Gerasimenko. The file was provided by ESA.
RPCMAG_INST.CAT	This file contains a complete instrument description of the orbiter magnetometer RPC-MAG.
RPCMAG_PERS.CAT	In the file all people responsible for the RPC-MAG data archiving are listed. Contact information is added.
RPCMAG_REF.CAT	The file contains publication references of all publications mentioned in the CATALOG files. Additionally all references to ESA documents are listed here. These references were provided by ESA.
RPCMAG_SOFTWARE.CAT	The file is empty, as no S/W will be provided.

3.4.3.4 Index Directory

This directory contains the index files generated by the ESA S/W PVV.
Additionally the GEOINDEX.LBL and GEOINDEX.TAB files will be located here

3.4.3.5 Browse Directory and Browse Files

N/A

3.4.3.6 Geometry Directory

The needed geometry information will be taken from the ancillary files provided by RSOC via the DDS.
These files are not PDS compliant. RSOC is responsible for archiving them. Thus, there will not be any GEOMETRY directory.

3.4.3.7 Software Directory

It is not planned to deliver any software.

3.4.3.8 Document Directory

Directory Structure:

```
—DOCUMENT
  |
  |—ARCHIVING
  |—CALIBRATION
  |—FLIGHT_REPORTS
```

Details about the content of this directory can be found in the DOCINFO.TXT file.

The ARCHIVING folder will contain this EAICD and the DDS2PDS Manual of the used IDL processing software (RO-IGEP-TR0007). The CALIBRATION directory contains the calibration protocols and analysis reports. Also a SETEP by STEP Calibration Procedure is added here.

The documents are saved in the original version as TeX or WORD or PDF files.

For a detailed instrument overview the Instrument Paper RPCMAG_INSTRUMENT is added as PDF version.

A good overview about all instrument operations and events occurring during flight is presented in the RPCMAG Logbook-file. This file is available in ASCII format. Most parts of this file are directly extracted from the DDS TC logging file and the DDS Events file.

3.4.3.9 Data Directory

Refer to 3.1.3

4 Detailed Interface Specifications

4.1 Structure and Organization Overview

The principle data directory structure sorted by data types was presented in chapter 3.1.3. The sortation with respect to the time is displayed in the following tree.

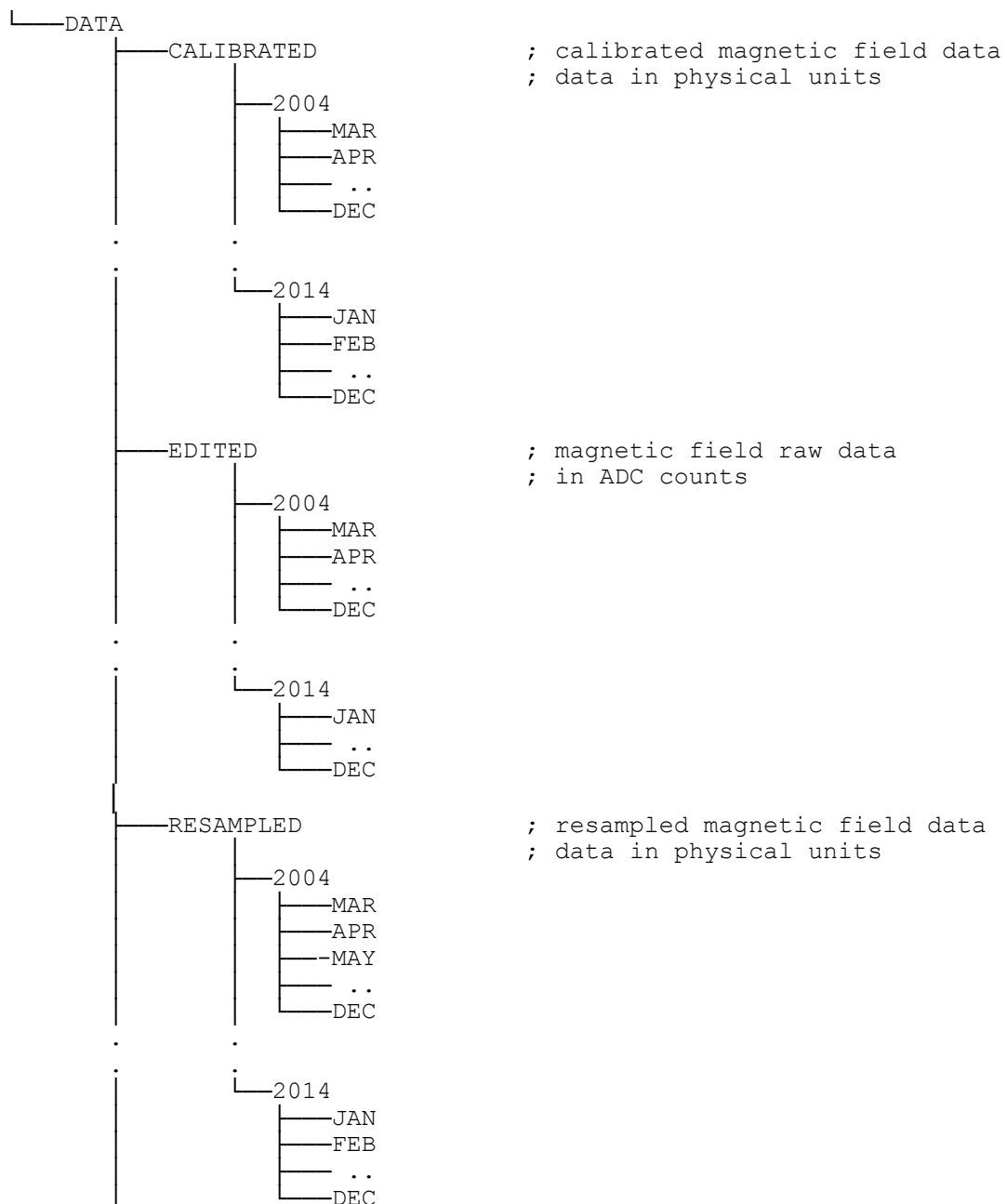

Each "Month" directory contains the different Level and sensor directories as described in Chapter 3.1.3. For the CALIBRATED data we have

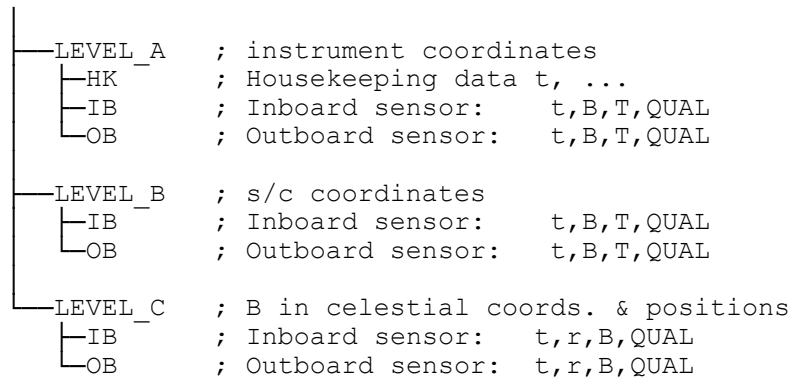

For the EDITED Data there are only the sensor and housekeeping subdirectories.

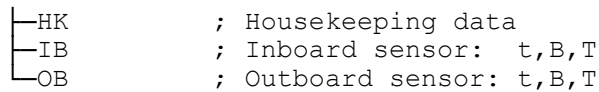

For the RESAMPLED data there are LEVEL_N n={E;F;G;H;I} data, which represent s second averaged data merged from all available mode files of the given day.

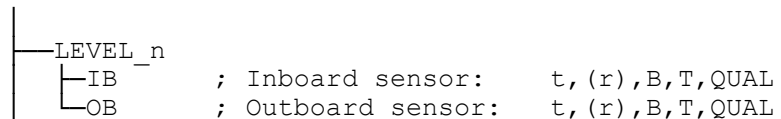

For the DERIVED data there are LEVEL_J data, which represent s second averaged data which are the output of a PCA analysis.

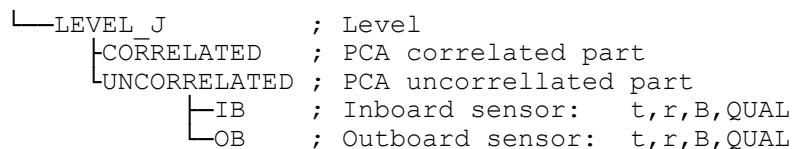

4.2 Data Sets, Definition and Content

We distinguish between four levels: EDITED, CALIBRATED, RESAMPLED, and DERIVED data.

The EDITED data just contain the decommutated TM data in units of ADC counts. Quality flags assign the data quality.

All calibrated data contain data in physical units like Nanotesla and Kelvin...This means, that the results of the ground calibration or inflight calibration have been applied to the data.

The CALIBRATED directory is divided in various sublevels:

- LEVEL_A data are data in instrument coordinates including also sensor temperatures.
S/C generated noise and residual fields are not taken into account.
- LEVEL_B data are magnetic field data in s/c coordinates including temperatures as well.
S/C generated noise and residual field are not taken into account.
- LEVEL_C data are data in celestial coordinates. Nominal s/c position and attitude have been considered during the evaluation. s/c generated noise and residual fields are not taken into account. Data contain s/c positions as well.

The RESAMPLED data are derived from the CALIBRATED data by averaging to a specified average period, e.g. 1second or 1 minute or correcting specific disturbance sources by application of special filters. This leads to

- LEVEL_K data.
These are calibrated, Lander heater influence corrected data in s/c- coordinates. Input were Lander corrected LEVEL_B tables. The elimination of the heater influence has been done by a different s/w in a semi-manual way.
S/C generated noise and residual fields are not taken into account. Different modes are taken into account if necessary. Data are not averaged but resampled due to filter algorithm.
Data of this calibration level will only be produced, if a heater influence occurred.
- LEVEL_L data.
These are calibrated, Lander heater influence corrected data celestial coordinates. Input were Lander corrected LEVEL_C data. The elimination of the heater influence has been done by a different s/w in a semi-manual way.
S/C generated noise and residual fields are not taken into account. Different modes are taken into account if necessary. Data are not averaged but resampled due to filter algorithm.
Data of this calibration level will only be produced, if a heater influence occurred.
- LEVEL_E data.
These are calibrated data in instrument coordinates. Input were LEVEL_A data.
S/C generated noise and residual fields are not taken into account. Data averaged. Different modes are taken into account if necessary. Used for internal use only.

- LEVEL_F data.

These are calibrated data in s/c-coordinates. Input were LEVEL_B or LEVEL_K data.

S/C generated noise and residual fields are not taken into account. Data averaged. Different modes are taken into account if necessary.

- LEVEL_G data.

These are calibrated data in celestial coordinates. S/C position and attitude have been considered during the evaluation. S/C generated noise and residual fields are not taken into account. Data contain s/c positions as well. Data averaged. Different modes are taken into account if necessary.

Input were LEVEL_C or LEVEL_L data.

- LEVEL_H data.

These data are derived from LEVEL_C or LEVEL_L data. A filter algorithm has been applied to get rid of the noise produced by ROSETTA's reaction wheels. Nominal S/C position and attitude have been considered during the evaluation. Residual fields are not taken into account. Data contain s/c positions as well. Data are not averaged but resampled due to filter algorithm in frequency domain.

- LEVEL_I data.

These are averaged LEVEL_H data in celestial coordinates. S/C position and attitude have been considered during the evaluation. Residual fields are not taken into account. Data contain s/c positions as well. Data are averaged. Different modes are taken into account if necessary.

The DERIVED data are derived from the CALIBRATED data. Currently there are only

- LEVEL_J data.

These data have been processed using a principal component analysis (PCA). As input LEVEL_G or LEVEL_I data can act.

As output two sets of files will be produced: correlated and uncorrelated data. The correlated data are the data which are supposed to represent the solar wind magnetic field. The uncorrelated (IB,OB) data represent the spacecraft noise.

Residual fields are not taken into account. Data averaged. The DC level of these magnetic field data is - per definition of a PCA – set to zero.

LEVEL_J data are currently used for internal purpose only. Therefore delivery is still TBD.

All data are stored in *.TAB files. All timeseries contain UTC and OBT spacecraft clock as time stamps. Data Sets will be created for each mission phase and delivered at convenient time afterwards. The data set will contain the data described in this document. It is not possible to state any exact data delivery date or data volume size as this is strongly dependent on the course of the mission.

4.3 Data Product Design

4.3.1 General OVERVIEW

We have three types of data:

- Housekeeping data (HK),
- Outboard sensor magnetic field data (OB) and
- Inboard sensor magnetic field data (IB).

The format of the HK data is different to the OB and the IB data. The latter have, however, the same format inside a given level. Magnetic field data exist for every level, whereas HK data only exist for EDITED and CALIBRATED LEVEL_A data.

A complete set of EDITED Data consists of HK, OB & IB data.
A complete set of LEVEL_A Data consists of HK, OB & IB data.
Higher level data only contain OB & IB data.

RAW data will be delivered as EDITED DATA in one DATA_SET.

LEVEL_A, LEVEL_B and LEVEL_C data will be delivered as CALIBRATED DATA in one DATA_SET.

LEVEL_K, LEVEL_L, LEVEL_E, LEVEL_F, LEVEL_G, LEVEL_H and LEVEL_I data will be delivered as RESAMPLED DATA in one DATA_SET.

LEVEL_J data will be delivered as DERIVED DATA in one DATA_SET (still TBD).

To reduce the data volume the standard delivery includes only EDITED DATA, CLA, CLB, CLC, CLF and CLG data. CLK, CLL, and CLH data will be produced if disturbances occur. CLE and CLJ data are normally only used for internal purpose and are not part of the standard data sets.

4.3.1.1 File Characteristics Data Elements

The *.LBL file will be identified by the FILE_NAME

4.3.1.2 Data Object Pointers Identification Data Elements

The only pointer which is used is the pointer from the *.LBL file to the *.TAB file.

4.3.1.3 Instrument and Detector Descriptive Data Elements

- INSTRUMENT_MODE_ID = "SID<n>"

The instrument can operate in six modes SID1 ... SID6 (n=1..6). Meaning:

- SID1: Minimum Mode
- SID2: Normal Mode
- SID3: Burst Mode
- SID4: Medium Mode
- SID5: Low Mode
- SID6: Test Mode

Mode	Sample Rate	Packet Period	Packet Length	Bit Rate	Vector Rate	Name
SID 1	1/32 Hz	1024 s	32 OB vec 1 IB vec	2 bits/s 0.0625 bits/s	0.03125 vec/s 0.000976 vec/s	Minimum Mode
SID 2	1 Hz	32 s	32 OB vec 1 IB vec	64 bits/s 2 bits/s	1 vec/s 0.03125 vec/s	Normal Mode
SID 3	20 Hz	16 s	320 OB vec 16 IB vec	1280 bits/s 64 bits/s	20 vec/s 1 vec/s	Burst Mode
SID 4	5 Hz	32 s	160 OB vec 1 IB vec	320 bits/s 2 bits/s	5 vec/s 0.03125 vec/s	Medium Mode
SID 5	¼ Hz	128 s	32 OB vec 1 IB vec	16 bits/s 0.5 bits/s	0.25 vec/s 0.007812 vec/s	Low Mode
SID 6	20 Hz	16 s	320 OB vec 1 IB vec	1280 bits/s 4 bits/s	20 vec/s 0.0625 vec/s	Test Mode
HK	1280 Hz Internal	32 s	8 words	4 bits/s		House Keeping

For every activated mode and calibration level there will be one single file for each day where data have been measured. This means that there can be data gaps in the file if e.g. there were some measurements in the morning and some others in the evening. Data for heater or reaction wheel corrected data will only be available if any disturbance occurred.

Mode SID6 is normally switched on only for a few minutes after powering the instrument. This is just a test mode and therefore, SID 6 data are not included in the datasets.

- INSTRUMENT_MODE_DESC = "<name> MODE: <p> PRIMARY & <s> SECONDARY
VECTORS PER <q> SECONDS"

The mode description explains exactly how many <p> primary vectors (usually OB) and how many <s> secondary vectors (usually IB) are generated Per <q> seconds and how this mode <name> is named.

- FLIGHT_SOFTWARE_VERSION_ID = "FIL:V1.0"

The coefficients of the digital filter in the MAG flight software can be changed during flight. The Flight software ID will take these features into account.

- PLATFORM_OR_MOUNTING_DESC = "MAGNETOMETER_BOOM: DEPLOYED"

The lower magnetometer boom has three positions: STOWED, moving during deployment, and DEPLOYED. For the launch it was stowed, and after the commissioning it will be deployed for the rest of the mission. The knowledge of the boom status is important for the right evaluation of the coordinate system.

4.3.1.4 Structure Definition of Instrument Parameter Objects

N/A

4.3.1.5 Data Object Definition

All data are stored in *.TAB files. Their structure is defined in the OBJECT Table definition within the *.LBL Files. Each data definition block has as DESCRIPTION which explains the meaning of the assigned data column exactly.

4.3.1.6 Description of Instrument

The detailed description of the instrument is done in the RPCMAG knowledge management video and in a brief overview in the RPCMAG_INST.CAT file. The video (RO_3DSE_MAG) is stored and administrated by ESA on the ROKSY server. It contains all available information about our instrument. Therefore, the access is limited to our instrument team.

Furthermore a detailed instrument description and first scientific results obtained during the first Earth Flyby in March 2005 can be found in our Instrument paper

RPC-MAG:The Fluxgate Magnetometer in the ROSETTA Plasma Consortium, Glassmeier, Richter, et al., Space Science Reviews,2006"

A copy of this paper is delivered in the DOCUMENT folder of each DATASET.

4.3.1.7 Parameters Index File Definition

N/A

4.3.1.8 Mission Specific Keyword

None

4.3.1.9 Geometry Information

ESA asked for GEOMETRY information in the *.LBL files. The RPCMAG team provides this in the following way:

```
SC_SUN_POSITION_VECTOR      = . . .  
SC_TARGET_POSITION_VECTOR  = . . .  
SC_TARGET_VELOCITY_VECTOR  = . . .  
SPACECRAFT_ALTITUDE        = . . .  
SUB_SPACECRAFT_LATITUDE    = . . .  
SUB_SPACECRAFT_LONGITUDE   = . . .  
NOTE                        ="
```

```
THE VALUES OF THE KEYWORDS SC_SUN_POSITION_VECTOR,  
SC_TARGET_POSITION_VECTOR AND SC_TARGET_VELOCITY_VECTOR,  
ARE RELATED TO THE ECLIPJ2000 REFERENCE FRAME.  
SUB_SPACECRAFT_LATITUDE AND SUB_SPACECRAFT_LONGITUDE  
ARE NORTHERN LATITUDE AND EASTERN LONGITUDE IN THE STANDARD  
PLANETOCENTRIC IAU <TARGET_NAME> FRAME. ALL VALUES ARE COMPUTED  
FOR THE TIME T= START_TIME.  
DISTANCES ARE GIVEN IN <KM> VELOCITIES IN <KM/S>, ANGLES IN <DEG>"
```

This means that the geometry items SC_SUN_POSITION_VECTOR, SC_TARGET_POSITION_VECTOR and SC_TARGET_VELOCITY_VECTOR provided in the label of the data product are related to the Ecliptic-J2000 frame. The SUB_SPACECRAFT_LATITUDE and SUB_SPACECRAFT_LONGITUDE, however, are related to the actual Planetocentric coordinate system. All the values are valid only for one particular time, the time given by the START_TIME value. All the distances are computed in Kilometers and all angles are given in degrees.

4.3.2 Data Product "EDITED Magnetic field data" Design

```

PDS_VERSION_ID           = PDS3
LABEL_REVISION_NOTE      = "V1.0"
RECORD_TYPE              = FIXED_LENGTH
RECORD_BYTES            = 79
FILE_RECORDS             = 2976
DATA_SET_ID              = "RO-A-RPCMAG-2-AST2-RAW-V3.0"
DATA_SET_NAME = "ROSETTA-ORBITER LUTETIA RPCMAG 2 AST2 RAW V3.0"
PRODUCT_ID               = "RPCMAG100707T1610_RAW_OB_M2"
PRODUCT_CREATION_TIME    = 2012-06-19T12:50:00
PRODUCT_TYPE             = "EDR"
MISSION_ID               = "ROSETTA"
MISSION_NAME              = "INTERNATIONAL ROSETTA MISSION"
MISSION_PHASE_NAME       = "LUTETIA FLY-BY"
OBSERVATION_TYPE         = "LUTETIA FLYBY"
INSTRUMENT_HOST_ID       = "RO"
INSTRUMENT_HOST_NAME     = "ROSETTA-ORBITER"
INSTRUMENT_ID            = "RPCMAG"
INSTRUMENT_NAME = "ROSETTA PLASMA CONSORTIUM - FLUXGATE MAGNETOMETER"
INSTRUMENT_TYPE          = "MAGNETOMETER"
INSTRUMENT_MODE_ID       = "SID2"
INSTRUMENT_MODE_DESC     = "
  NORMAL MODE: 32 PRIMARY & 1 SECONDARY VECTORS PER 32 SECONDS"
TARGET_NAME              = "21 LUTETIA"
TARGET_TYPE              = "ASTEROID"
START_TIME               = 2010-07-07T16:10:34.762
STOP_TIME                = 2010-07-07T17:00:12.696
SPACECRAFT_CLOCK_START_COUNT = "1/237139793.53975"
SPACECRAFT_CLOCK_STOP_COUNT = "1/237142771.49676"

START_JULIAN_DATE_VALUE  = 2455385.1740134498
STOP_JULIAN_DATE_VALUE   = 2455385.2084802785
SC_SUN_POSITION_VECTOR   = ( 398355915.91, 61201290.76, -20680693.95)
SC_TARGET_POSITION_VECTOR = ( -3861891.65, 110582.37, 59989.77)
SC_TARGET_VELOCITY_VECTOR = ( 14.99, -0.44, -0.23)
SPACECRAFT_ALTITUDE      = 3863883.127
SUB_SPACECRAFT_LATITUDE  = "N/A"
SUB_SPACECRAFT_LONGITUDE = "N/A"
SPICE_FILE_NAME          = {"ATNR_P040302093352_00125.BC",
  "ROS_LBOOM_V0.BC",
  "ROS_V18.TF",
  "ROS_SA_2004_V0001.BC",
  "ROS_SA_2005_V0001.BC",
  "ROS_SA_2006_V0001.BC",
  "ROS_SA_2007_V0001.BC",
  "ROS_SA_2008_V0038.BC",
  "ROS_SA_2009_V0054.BC",
  "ROS_SA_2010_V0052.BC",
  "ROS_SA_2011_V0013.BC",
  "ROS_HGA_2008_V0018.BC",
  "ROS_HGA_2009_V0051.BC",
  "ROS_HGA_2010_V0045.BC",
  "ROS_HGA_2011_V0009.BC",
  "ROS_RPC_V15.TI",

```

"NAIF0010.TLS",
"PCK00010.TPC",
"DE403-MASSES.TPC",
"ROS_110405_STEP.TSC",
"ORER_____00031.BSP",
"ORFR_____00067.BSP",
"ORGR_____00096.BSP",
"ORHR_____00122.BSP",
"ORMR_____00052.BSP",
"ORHO_____00077.BSP",
"ROS_RPC_STRUCT_V1.BSP",
"ROS_STRUCT_V2.BSP",
"EARTH_TOPO_050714.TF",
"EARTHFIXEDIAU.TF",
"EARTHFIXEDITRF93.TF",
"RSSD0002.TF",
"LUTETIA_CSEQ.TF",
"ROS_LUTETIA_RSOC_V01.TF",
"EARTH_000101_060918_060627.BPC",
"ROS_LUTETIA_LC1_V02.TPC",
"ROS_LUTETIA_LC2_V02.TPC",
"ROS_LUTETIA_R1_V02.TPC",
"ROS_LUTETIA_R2_V02.TPC",
"ROS_LUTETIA_RSOC_V03.TPC",
"DE405.BSP",
"DSNSTNS.BSP",
"ORHS_____00109.BSP"}

PRODUCER_ID = "RPC_MAG_TEAM"
PRODUCER_FULL_NAME = "INGO RICHTER"
PRODUCER_INSTITUTION_NAME = "IGEP-TU-BRAUNSCHWEIG"
DATA_QUALITY_ID = "N/A"
DATA_QUALITY_DESC = "

THE DATA QUALITY IS CODED FOR EACH VECTOR IN THE LAST COLUMN OF THE TABLE.
CODE: 0= GOOD DATA; 1= BAD DATA -- EACH SENSOR HAS ITS OWN QUALITY BIT --
BIT0:X, BIT1:Y, BIT2:Z, BIT3=0:OB, BIT3=1 IB"

PROCESSING_LEVEL_ID = "2"

DESCRIPTION = "

THIS FILE CONTAINS MAGNETIC FIELD VECTOR RAW DATA OBTAINED BY THE OUTBOARD
MAGNETOMETER ABOARD THE ROSETTA S/C AND THE TEMPERATURE OF THE OUTBOARD
SENSOR. ALL VALUES ARE 20 BIT ADC COUNTS.

FIELD IS GIVEN IN INSTRUMENT COORDINATES"

FLIGHT_SOFTWARE_VERSION_ID = "FIL:V1.0"

PLATFORM_OR_MOUNTING_DESC = "MAGNETOMETER_BOOM: DEPLOYED"

NOTE = "

a)
MAGNETIC_COORDINATE_SYSTEM : INSTRUMENTCOORDS

b)
THE VALUES OF THE KEYWORDS SC_SUN_POSITION_VECTOR,
SC_TARGET_POSITION_VECTOR AND SC_TARGET_VELOCITY_VECTOR,
ARE RELATED TO THE ECLIPJ2000 REFERENCE FRAME.
SUB_SPACECRAFT_LATITUDE AND SUB_SPACECRAFT_LONGITUDE
ARE NORTHERN LATITUDE AND EASTERN LONGITUDE IN THE STANDARD
PLANETOCENTRIC IAU <TARGET_NAME> FRAME. ALL VALUES ARE COMPUTED
FOR THE TIME T= START_TIME.
DISTANCES ARE GIVEN IN <KM> VELOCITIES IN <KM/S>, ANGLES IN <DEG>

c)
LBL & TAB FILE HAVE BEEN GENERATED BY S/W: GEN_CAL_DATA, VERSION V20101210

```

^TABLE                = "RPCMAG100707T1610_RAW_OB_M2.TAB"

OBJECT                = TABLE
NAME                  = "RPCMAG-OB-SID2-RAW"
INTERCHANGE_FORMAT   = ASCII
ROWS                  = 2976
COLUMNS              = 7
ROW_BYTES            = 79

OBJECT                = COLUMN
NAME                  = "TIME.UTC"
DATA_TYPE             = TIME
START_BYTE           = 1
BYTES                 = 26
DESCRIPTION           = "UTC TIME OF OBSERVATION: YYYY-MM-DDTHH:MM:SS.FFFFFFFF"
END_OBJECT            = COLUMN

OBJECT                = COLUMN
NAME                  = "TIME.OBT"
DATA_TYPE             = ASCII_REAL
START_BYTE           = 28
BYTES                 = 15
DESCRIPTION           = "S/C CLOCK AT OBSERVATION TIME,SECONDS SINCE 00:00
  AT 1.1.2003: SSSSSSSS.FFFFFF"
END_OBJECT            = COLUMN

OBJECT                = COLUMN
NAME                  = "BX.OB"
DATA_TYPE             = ASCII_INTEGER
START_BYTE           = 44
BYTES                 = 7
UNIT                  = "N/A"
DESCRIPTION           = "
  MAGNETIC FIELD X COMPONENT, UNCALIBRATED RAW DATA,
  INSTRUMENT COORDINATES, OB SENSOR.
  VALUE IS GIVEN IN ADC_COUNTS"
END_OBJECT            = COLUMN

OBJECT                = COLUMN
NAME                  = "BY.OB"
DATA_TYPE             = ASCII_INTEGER
START_BYTE           = 52
BYTES                 = 7
UNIT                  = "N/A"
DESCRIPTION           = "MAGNETIC FIELD Y COMPONENT, UNCALIBRATED RAW DATA,
  INSTRUMENT COORDINATES, OB SENSOR.
  VALUE IS GIVEN IN ADC_COUNTS"
END_OBJECT            = COLUMN

OBJECT                = COLUMN
NAME                  = "BZ.OB"
DATA_TYPE             = ASCII_INTEGER
START_BYTE           = 60
BYTES                 = 7
UNIT                  = "N/A"
DESCRIPTION           = "MAGNETIC FIELD Z COMPONENT, UNCALIBRATED RAW DATA,
  INSTRUMENT COORDINATES, OB SENSOR.
  VALUE IS GIVEN IN ADC_COUNTS"
END_OBJECT            = COLUMN

```

```

OBJECT          = COLUMN
NAME            = "T OB"
DATA_TYPE      = ASCII_INTEGER
START_BYTE     = 68
BYTES          = 7
UNIT           = "N/A"
DESCRIPTION    = "RAW TEMPERATURE OF RPCMAG OB SENSOR.
VALUE IS GIVEN IN ADC COUNTS"
END_OBJECT     = COLUMN

OBJECT          = COLUMN
NAME            = "QUALITY"
DATA_TYPE      = ASCII_INTEGER
START_BYTE     = 76
BYTES          = 2
DESCRIPTION    = "REFER TO DATA_QUALITY_DESC. VALUE REPRESENTS A FLAG"
END_OBJECT     = COLUMN

END_OBJECT     = TABLE
END

```

4.3.3 Data Product "EDITED Housekeeping data" Design

```

PDS_VERSION_ID          = PDS3
LABEL_REVISION_NOTE     = "V1.0"
RECORD_TYPE             = FIXED_LENGTH
RECORD_BYTES            = 106
FILE_RECORDS            = 934
DATA_SET_ID             = "RO-A-RPCMAG-2-AST2-RAW-V3.0"
DATA_SET_NAME = "ROSETTA-ORBITER LUTETIA RPCMAG 2 AST2 RAW V3.0"
PRODUCT_ID              = "RPCMAG100707T1542_RAW_HK"
PRODUCT_CREATION_TIME   = 2012-06-19T12:50:00
PRODUCT_TYPE            = "EDR"
MISSION_ID              = "ROSETTA"
MISSION_NAME            = "INTERNATIONAL ROSETTA MISSION"
MISSION_PHASE_NAME     = "LUTETIA FLY-BY"
OBSERVATION_TYPE       = "LUTETIA FLYBY"
INSTRUMENT_HOST_ID     = "RO"
INSTRUMENT_HOST_NAME   = "ROSETTA-ORBITER"
INSTRUMENT_ID          = "RPCMAG"
INSTRUMENT_NAME = "ROSETTA PLASMA CONSORTIUM - FLUXGATE MAGNETOMETER"
INSTRUMENT_TYPE        = "MAGNETOMETER"
INSTRUMENT_MODE_ID     = "HK"
INSTRUMENT_MODE_DESC   = "HOUSEKEEPING MODE: 8 WORDS PER 32 SECONDS"
TARGET_NAME            = "21 LUTETIA"
TARGET_TYPE            = "ASTEROID"
START_TIME              = 2010-07-07T15:42:19.594
STOP_TIME               = 2010-07-07T23:59:55.596
SPACECRAFT_CLOCK_START_COUNT = "1/237138098.65587"
SPACECRAFT_CLOCK_STOP_COUNT  = "1/237167954.65587"

START_JULIAN_DATE_VALUE = 2455385.1543934494
STOP_JULIAN_DATE_VALUE  = 2455385.4999490282

```



```

SC_SUN_POSITION_VECTOR      = ( 398337981.36,  61174297.08, -20680933.09)
SC_TARGET_POSITION_VECTOR  = ( -3887300.97,   111329.78,   60380.47)
SC_TARGET_VELOCITY_VECTOR  = (    14.99,    -0.44,    -0.23)
SPACECRAFT_ALTITUDE        =      3889309.855
SUB_SPACECRAFT_LATITUDE    = "N/A"
SUB_SPACECRAFT_LONGITUDE   = "N/A"
SPICE_FILE_NAME            = {"ATNR_P040302093352_00125.BC",
                              "ROS_LBOOM_V0.BC",
                              "ROS_V18.TF",
                              "ROS_SA_2004_V0001.BC",
                              "ROS_SA_2005_V0001.BC",
                              "ROS_SA_2006_V0001.BC",
                              "ROS_SA_2007_V0001.BC",
                              "ROS_SA_2008_V0038.BC",
                              "ROS_SA_2009_V0054.BC",
                              "ROS_SA_2010_V0052.BC",
                              "ROS_SA_2011_V0013.BC",
                              "ROS_HGA_2008_V0018.BC",
                              "ROS_HGA_2009_V0051.BC",
                              "ROS_HGA_2010_V0045.BC",
                              "ROS_HGA_2011_V0009.BC",
                              "ROS_RPC_V15.TI",
                              "NAIF0010.TLS",
                              "PCK00010.TPC",
                              "DE403-MASSES.TPC",
                              "ROS_110405_STEP.TSC",
                              "ORER_____00031.BSP",
                              "ORFR_____00067.BSP",
                              "ORGR_____00096.BSP",
                              "ORHR_____00122.BSP",
                              "ORMR_____00052.BSP",
                              "ORHO_____00077.BSP",
                              "ROS_RPC_STRUCT_V1.BSP",
                              "ROS_STRUCT_V2.BSP",
                              "EARTH_TOPO_050714.TF",
                              "EARTHFIXEDIAU.TF",
                              "EARTHFIXEDITRF93.TF",
                              "RSSD0002.TF",
                              "LUTETIA_CSEQ.TF",
                              "ROS_LUTETIA_RSOC_V01.TF",
                              "EARTH_000101_060918_060627.BPC",
                              "ROS_LUTETIA_LC1_V02.TPC",
                              "ROS_LUTETIA_LC2_V02.TPC",
                              "ROS_LUTETIA_R1_V02.TPC",
                              "ROS_LUTETIA_R2_V02.TPC",
                              "ROS_LUTETIA_RSOC_V03.TPC",
                              "DE405.BSP",
                              "DSNSTNS.BSP",
                              "ORHS_____00109.BSP"}

PRODUCER_ID                 = "RPC_MAG_TEAM"
PRODUCER_FULL_NAME         = "INGO RICHTER"
PRODUCER_INSTITUTION_NAME = "IGEP-TU-BRAUNSCHWEIG"
DATA_QUALITY_ID            = "N/A"
DATA_QUALITY_DESC          = "N/A"
PROCESSING_LEVEL_ID        = "2"

DESCRIPTION                 = "
THIS FILE CONTAINS HOUSEKEEPING RAW DATA OBTAINED BY THE FLUXGATE
MAGNETOMETER ABOARD THE ROSETTA S/C. ALL VALUES ARE 20 BIT ADC COUNTS."

```

FLIGHT_SOFTWARE_VERSION_ID = "FIL:V1.0"
PLATFORM_OR_MOUNTING_DESC = "MAGNETOMETER_BOOM: DEPLOYED"

NOTE = "

a)

MAGNETIC_COORDINATE_SYSTEM : INSTRUMENTCOORDS

b)

THE VALUES OF THE KEYWORDS SC_SUN_POSITION_VECTOR,
SC_TARGET_POSITION_VECTOR AND SC_TARGET_VELOCITY_VECTOR,
ARE RELATED TO THE ECLIPJ2000 REFERENCE FRAME.
SUB_SPACECRAFT_LATITUDE AND SUB_SPACECRAFT_LONGITUDE
ARE NORTHERN LATITUDE AND EASTERN LONGITUDE IN THE STANDARD
PLANETOCENTRIC IAU <TARGET_NAME> FRAME. ALL VALUES ARE COMPUTED
FOR THE TIME T= START_TIME.
DISTANCES ARE GIVEN IN <KM> VELOCITIES IN <KM/S>, ANGLES IN <DEG>

c)

LBL & TAB FILE HAVE BEEN GENERATED BY S/W: GEN_CAL_DATA, VERSION V20101210

^TABLE = "RPCMAG100707T1542_RAW_HK.TAB"

OBJECT = TABLE
NAME = "RPCMAG-HK-RAW"
INTERCHANGE_FORMAT = ASCII
ROWS = 934
COLUMNS = 13
ROW_BYTES = 106

OBJECT = COLUMN
NAME = "TIME.UTC"
DATA_TYPE = TIME
START_BYTE = 1
BYTES = 26
DESCRIPTION = "UTC TIME OF OBSERVATION: YYYY-MM-DDTHH:MM:SS.FFFFFFFF"
END_OBJECT = COLUMN

OBJECT = COLUMN
NAME = "TIME.OBT"
DATA_TYPE = ASCII_REAL
START_BYTE = 28
BYTES = 15
DESCRIPTION = "S/C CLOCK AT OBSERVATION TIME, SECONDS SINCE 00:00
AT 1.1.2003: SSSSSSSSS.FFFFFF"
END_OBJECT = COLUMN

OBJECT = COLUMN
NAME = "T.OB"
DATA_TYPE = ASCII_INTEGER
START_BYTE = 44
BYTES = 7
UNIT = "N/A"
DESCRIPTION = "
TEMPERATURE OF THE RPCMAG OUTBOARD SENSOR.
VALUE IS GIVEN IN ADC_COUNTS"
END_OBJECT = COLUMN

OBJECT = COLUMN
NAME = "T.IB"
DATA_TYPE = ASCII_INTEGER
START_BYTE = 52
BYTES = 7

```

UNIT                = "N/A"
DESCRIPTION         = "
    TEMPERATURE OF THE RPCMAG INBOARD SENSOR.
    VALUE IS GIVEN IN ADC_COUNTS"
END_OBJECT         = COLUMN

OBJECT              = COLUMN
NAME                = "STAGE_A_ID"
DATA_TYPE           = ASCII_INTEGER
START_BYTE         = 60
BYTES               = 1
DESCRIPTION         = "FILTER TYPE IDENTIFICATION FLAG A"
END_OBJECT         = COLUMN

OBJECT              = COLUMN
NAME                = "STAGE_B_ID"
DATA_TYPE           = ASCII_INTEGER
START_BYTE         = 62
BYTES               = 1
DESCRIPTION         = "FILTER TYPE IDENTIFICATION FLAG B"
END_OBJECT         = COLUMN

OBJECT              = COLUMN
NAME                = "FILTER_CFG"
DATA_TYPE           = ASCII_INTEGER
START_BYTE         = 64
BYTES               = 1
DESCRIPTION         = "FILTER CONFIGURATION FLAG"
END_OBJECT         = COLUMN

OBJECT              = COLUMN
NAME                = "MAG_REF_VOLTAGE"
DATA_TYPE           = ASCII_INTEGER
START_BYTE         = 66
BYTES               = 7
UNIT                = "N/A"
DESCRIPTION         = "
    MAGNETOMETER REFERENCE VOLTAGE: 2.5 V.
    VALUE IS GIVEN IN ADC_COUNTS"
END_OBJECT         = COLUMN

OBJECT              = COLUMN
NAME                = "MAG_NEG_VOLTAGE"
DATA_TYPE           = ASCII_INTEGER
START_BYTE         = 74
BYTES               = 3
UNIT                = "N/A"
DESCRIPTION         = "
    MAGNETOMETER NEGATIVE SUPPLY VOLTAGE:-5V.
    VALUE IS GIVEN IN ADC_COUNTS"
END_OBJECT         = COLUMN

OBJECT              = COLUMN
NAME                = "MAG_POS_VOLTAGE"
DATA_TYPE           = ASCII_INTEGER
START_BYTE         = 78
BYTES               = 3
UNIT                = "N/A"
DESCRIPTION         = "
    MAGNETOMETER POSITIVE SUPPLY VOLTAGE:+5V.

```

```
VALUE IS GIVEN IN ADC_COUNTS"
END_OBJECT          = COLUMN

OBJECT              = COLUMN
NAME                = "BX_OB"
DATA_TYPE           = ASCII_INTEGER
START_BYTE         = 82
BYTES               = 7
UNIT                = "N/A"
DESCRIPTION         = "
    MAGNETIC FIELD X COMPONENT, UNCALIBRATED RAW DATA,
    INSTRUMENT COORDINATES, OB-SENSOR.
VALUE IS GIVEN IN ADC_COUNTS"
END_OBJECT          = COLUMN

OBJECT              = COLUMN
NAME                = "BY_OB"
DATA_TYPE           = ASCII_INTEGER
START_BYTE         = 90
BYTES               = 7
UNIT                = "N/A"
DESCRIPTION         = "
    MAGNETIC FIELD Y COMPONENT, UNCALIBRATED RAW DATA,
    INSTRUMENT COORDINATES, OB-SENSOR.
VALUE IS GIVEN IN ADC_COUNTS"
END_OBJECT          = COLUMN

OBJECT              = COLUMN
NAME                = "BZ_OB"
DATA_TYPE           = ASCII_INTEGER
START_BYTE         = 98
BYTES               = 7
UNIT                = "N/A"
DESCRIPTION         = "
    MAGNETIC FIELD Z COMPONENT, UNCALIBRATED RAW DATA,
    INSTRUMENT COORDINATES, OB-SENSOR.
VALUE IS GIVEN IN ADC_COUNTS"
END_OBJECT          = COLUMN

END_OBJECT          = TABLE
END
```

4.3.4 Data Product "CALIBRATED LEVEL_A Housekeeping data" Design

```

PDS_VERSION_ID           = PDS3
LABEL_REVISION_NOTE      = "V1.0"
RECORD_TYPE              = FIXED_LENGTH
RECORD_BYTES            = 114
FILE_RECORDS            = 933
DATA_SET_ID              = "RO-A-RPCMAG-3-AST2-CALIBRATED-V3.0"
DATA_SET_NAME = "ROSETTA-ORBITER LUTETIA RPCMAG 3 AST2 CALIBRATED V3.0"
PRODUCT_ID              = "RPCMAG100707T1542_CLA_HK"
PRODUCT_CREATION_TIME    = 2012-06-19T12:50:00
PRODUCT_TYPE            = "RDR"
MISSION_ID              = "ROSETTA"
MISSION_NAME            = "INTERNATIONAL ROSETTA MISSION"
MISSION_PHASE_NAME      = "LUTETIA FLY-BY"
OBSERVATION_TYPE        = "LUTETIA FLYBY"
INSTRUMENT_HOST_ID      = "RO"
INSTRUMENT_HOST_NAME    = "ROSETTA-ORBITER"
INSTRUMENT_ID           = "RPCMAG"
INSTRUMENT_NAME = "ROSETTA PLASMA CONSORTIUM - FLUXGATE MAGNETOMETER"
INSTRUMENT_TYPE         = "MAGNETOMETER"
INSTRUMENT_MODE_ID      = "HK"
INSTRUMENT_MODE_DESC    = "HOUSEKEEPING MODE: 8 WORDS PER 32 SECONDS"
TARGET_NAME             = "21 LUTETIA"
TARGET_TYPE             = "ASTEROID"
START_TIME              = 2010-07-07T15:42:51.594
STOP_TIME               = 2010-07-07T23:59:55.596
SPACECRAFT_CLOCK_START_COUNT = "1/237138098.65587"
SPACECRAFT_CLOCK_STOP_COUNT  = "1/237167954.65587"

START_JULIAN_DATE_VALUE  = 2455385.1547638201
STOP_JULIAN_DATE_VALUE  = 2455385.4999490282
SC_SUN_POSITION_VECTOR  = ( 398338319.93, 61174806.65, -20680928.58)
SC_TARGET_POSITION_VECTOR = ( -3886821.32, 111315.67, 60373.09)
SC_TARGET_VELOCITY_VECTOR = ( 14.99, -0.44, -0.23)
SPACECRAFT_ALTITUDE     = 3888829.862
SUB_SPACECRAFT_LATITUDE = "N/A"
SUB_SPACECRAFT_LONGITUDE = "N/A"
SPICE_FILE_NAME         = {"ATNR_P040302093352_00125.BC",
                          "ROS_LBOOM_V0.BC",
                          "ROS_V18.TF",
                          "ROS_SA_2004_V0001.BC",
                          "ROS_SA_2005_V0001.BC",
                          "ROS_SA_2006_V0001.BC",
                          "ROS_SA_2007_V0001.BC",
                          "ROS_SA_2008_V0038.BC",
                          "ROS_SA_2009_V0054.BC",
                          "ROS_SA_2010_V0052.BC",
                          "ROS_SA_2011_V0013.BC",
                          "ROS_HGA_2008_V0018.BC",
                          "ROS_HGA_2009_V0051.BC",
                          "ROS_HGA_2010_V0045.BC",
                          "ROS_HGA_2011_V0009.BC",
                          "ROS_RPC_V15.TI",
                          "NAIF0010.TLS",
                          "PCK00010.TPC",

```

"DE403-MASSES.TPC",
"ROS_110405_STEP.TSC",
"ORER_____00031.BSP",
"ORFR_____00067.BSP",
"ORGR_____00096.BSP",
"ORHR_____00122.BSP",
"ORMR_____00052.BSP",
"ORHO_____00077.BSP",
"ROS_RPC_STRUCT_V1.BSP",
"ROS_STRUCT_V2.BSP",
"EARTH_TOPO_050714.TF",
"EARTHFIXEDIAU.TF",
"EARTHFIXEDITRF93.TF",
"RSSD0002.TF",
"LUTETIA_CSEQ.TF",
"ROS_LUTETIA_RSOC_V01.TF",
"EARTH_000101_060918_060627.BPC",
"ROS_LUTETIA_LC1_V02.TPC",
"ROS_LUTETIA_LC2_V02.TPC",
"ROS_LUTETIA_R1_V02.TPC",
"ROS_LUTETIA_R2_V02.TPC",
"ROS_LUTETIA_RSOC_V03.TPC",
"DE405.BSP",
"DSNSTNS.BSP",
"ORHS_____00109.BSP"}

PRODUCER_ID = "RPC_MAG_TEAM"
PRODUCER_FULL_NAME = "INGÖ RICHTER"
PRODUCER_INSTITUTION_NAME = "IGEP-TU-BRAUNSCHWEIG"
DATA_QUALITY_ID = "N/A"
DATA_QUALITY_DESC = "N/A"
PROCESSING_LEVEL_ID = "3"

DESCRIPTION = "
THIS FILE CONTAINS HOUSEKEEPING RAW DATA OBTAINED BY THE FLUXGATE
MAGNETOMETER ABOARD THE ROSETTA S/C. ENTITIES ARE CONVERTED TO PHYSICAL
UNITS. MAGNETIC FIELD IN INSTRUMENT COORDINATES.
NO ALIGNMENT, SENSITIVITY OR TEMPERATURE CORRECTIONS."
FLIGHT_SOFTWARE_VERSION_ID = "FIL:V1.0"
PLATFORM_OR_MOUNTING_DESC = "MAGNETOMETER_BOOM: DEPLOYED"

NOTE = "
a)
MAGNETIC_COORDINATE_SYSTEM : INSTRUMENTCOORDS
b)
THE VALUES OF THE KEYWORDS SC_SUN_POSITION_VECTOR,
SC_TARGET_POSITION_VECTOR AND SC_TARGET_VELOCITY_VECTOR,
ARE RELATED TO THE ECLIPJ2000 REFERENCE FRAME.
SUB_SPACECRAFT_LATITUDE AND SUB_SPACECRAFT_LONGITUDE
ARE NORTHERN LATITUDE AND EASTERN LONGITUDE IN THE STANDARD
PLANETOCENTRIC IAU <TARGET_NAME> FRAME. ALL VALUES ARE COMPUTED
FOR THE TIME T= START_TIME.
DISTANCES ARE GIVEN IN <KM> VELOCITIES IN <KM/S>, ANGLES IN <DEG>
c)
LBL & TAB FILE HAVE BEEN GENERATED BY S/W: GEN_CAL_DATA, VERSION V20101210

^TABLE = "RPCMAG100707T1542_CLA_HK.TAB"

OBJECT = TABLE
NAME = "RPCMAG-HK-RAW"

```

INTERCHANGE_FORMAT = ASCII
ROWS                = 933
COLUMNS            = 13
ROW_BYTES           = 114

OBJECT              = COLUMN
NAME                = "TIME.UTC"
DATA_TYPE           = TIME
START_BYTE         = 1
BYTES               = 26
DESCRIPTION         = "UTC TIME OF OBSERVATION: YYYY-MM-DDTHH:MM:SS.FFFFFFFF"
END_OBJECT          = COLUMN

OBJECT              = COLUMN
NAME                = "TIME.OBT"
DATA_TYPE           = ASCII_REAL
START_BYTE         = 28
BYTES               = 15
DESCRIPTION         = "S/C CLOCK AT OBSERVATION TIME,SECONDS SINCE 00:00
  AT 1.1.2003: SSSSSSSS.FFFFFF"
END_OBJECT          = COLUMN

OBJECT              = COLUMN
NAME                = "T.OB"
DATA_TYPE           = ASCII_REAL
START_BYTE         = 44
BYTES               = 6
UNIT                = "KELVIN"
DESCRIPTION         = "TEMPERATURE OF THE RPCMAG OUTBOARD SENSOR"
END_OBJECT          = COLUMN

OBJECT              = COLUMN
NAME                = "T.IB"
DATA_TYPE           = ASCII_REAL
START_BYTE         = 51
BYTES               = 6
UNIT                = "KELVIN"
DESCRIPTION         = "TEMPERATURE OF THE RPCMAG INBOARD SENSOR"
END_OBJECT          = COLUMN

OBJECT              = COLUMN
NAME                = "STAGE_A.ID"
DATA_TYPE           = ASCII_INTEGER
START_BYTE         = 58
BYTES               = 1
DESCRIPTION         = "FILTER TYPE IDENTIFICATION FLAG A"
END_OBJECT          = COLUMN

OBJECT              = COLUMN
NAME                = "STAGE_B.ID"
DATA_TYPE           = ASCII_INTEGER
START_BYTE         = 60
BYTES               = 1
DESCRIPTION         = "FILTER TYPE IDENTIFICATION FLAG B"
END_OBJECT          = COLUMN

OBJECT              = COLUMN
NAME                = "FILTER_CFG"
DATA_TYPE           = ASCII_INTEGER
START_BYTE         = 62

```

```

BYTES                = 1
DESCRIPTION          = "FILTER CONFIGURATION FLAG"
END_OBJECT          = COLUMN

OBJECT              = COLUMN
NAME                = "MAG_REF_VOLTAGE"
DATA_TYPE           = ASCII_REAL
START_BYTE         = 64
BYTES              = 8
UNIT               = "VOLT"
DESCRIPTION        = "MAGNETOMETER REFERENCE VOLTAGE: 2.5 V"
END_OBJECT        = COLUMN

OBJECT              = COLUMN
NAME                = "MAG_NEG_VOLTAGE"
DATA_TYPE           = ASCII_REAL
START_BYTE         = 73
BYTES              = 6
UNIT               = "VOLT"
DESCRIPTION        = "MAGNETOMETER NEGATIVE SUPPLY VOLTAGE:-5V"
END_OBJECT        = COLUMN

OBJECT              = COLUMN
NAME                = "MAG_POS_VOLTAGE"
DATA_TYPE           = ASCII_REAL
START_BYTE         = 80
BYTES              = 6
UNIT               = "VOLT"
DESCRIPTION        = "MAGNETOMETER POSITIVE SUPPLY VOLTAGE:+5V"
END_OBJECT        = COLUMN

OBJECT              = COLUMN
NAME                = "BX_OB"
DATA_TYPE           = ASCII_REAL
START_BYTE         = 87
BYTES              = 8
UNIT               = "NANOTESLA"
DESCRIPTION        = "MAGNETIC FIELD X COMPONENT, CONVERTED RAW DATA,
INSTRUMENT COORDINATES, OB-SENSOR"
END_OBJECT        = COLUMN

OBJECT              = COLUMN
NAME                = "BY_OB"
DATA_TYPE           = ASCII_REAL
START_BYTE         = 96
BYTES              = 8
UNIT               = "NANOTESLA"
DESCRIPTION        = "MAGNETIC FIELD Y COMPONENT, CONVERTED RAW DATA,
INSTRUMENT COORDINATES, OB-SENSOR"
END_OBJECT        = COLUMN

OBJECT              = COLUMN
NAME                = "BZ_OB"
DATA_TYPE           = ASCII_REAL
START_BYTE         = 105
BYTES              = 8
UNIT               = "NANOTESLA"
DESCRIPTION        = "MAGNETIC FIELD Z COMPONENT, CONVERTED RAW DATA,
INSTRUMENT COORDINATES, OB-SENSOR"
END_OBJECT        = COLUMN

```

END_OBJECT = TABLE
END

4.3.5 Data Product "CALIBRATED LEVEL_A Magnetic Field data" Design

```

PDS_VERSION_ID = PDS3
LABEL_REVISION_NOTE = "V1.0"
RECORD_TYPE = FIXED_LENGTH
RECORD_BYTES = 90
FILE_RECORDS = 2976
DATA_SET_ID = "RO-A-RPCMAG-3-AST2-CALIBRATED-V3.0"
DATA_SET_NAME = "ROSETTA-ORBITER LUTETIA RPCMAG 3 AST2 CALIBRATED V3.0"
PRODUCT_ID = "RPCMAG100707T1610_CLA_OB_M2"
PRODUCT_CREATION_TIME = 2012-06-19T12:50:00
PRODUCT_TYPE = "RDR"
MISSION_ID = "ROSETTA"
MISSION_NAME = "INTERNATIONAL ROSETTA MISSION"
MISSION_PHASE_NAME = "LUTETIA FLY-BY"
OBSERVATION_TYPE = "LUTETIA FLYBY"
INSTRUMENT_HOST_ID = "RO"
INSTRUMENT_HOST_NAME = "ROSETTA-ORBITER"
INSTRUMENT_ID = "RPCMAG"
INSTRUMENT_NAME = "ROSETTA PLASMA CONSORTIUM - FLUXGATE MAGNETOMETER"
INSTRUMENT_TYPE = "MAGNETOMETER"
INSTRUMENT_MODE_ID = "SID2"
INSTRUMENT_MODE_DESC = "
    NORMAL MODE: 32 PRIMARY & 1 SECONDARY VECTORS PER 32 SECONDS"
TARGET_NAME = "21 LUTETIA"
TARGET_TYPE = "ASTEROID"
START_TIME = 2010-07-07T16:10:42.962
STOP_TIME = 2010-07-07T17:00:20.896
SPACECRAFT_CLOCK_START_COUNT = "1/237139793.53975"
SPACECRAFT_CLOCK_STOP_COUNT = "1/237142771.49676"

START_JULIAN_DATE_VALUE = 2455385.1741083572
STOP_JULIAN_DATE_VALUE = 2455385.2085751859
SC_SUN_POSITION_VECTOR = ( 398356002.66, 61201421.33, -20680692.79)
SC_TARGET_POSITION_VECTOR = ( -3861768.74, 110578.75, 59987.88)
SC_TARGET_VELOCITY_VECTOR = ( 14.99, -0.44, -0.23)
SPACECRAFT_ALTITUDE = 3863760.134
SUB_SPACECRAFT_LATITUDE = "N/A"
SUB_SPACECRAFT_LONGITUDE = "N/A"
SPICE_FILE_NAME = {"ATNR_P040302093352_00125.BC",
    "ROS_LBOOM_V0.BC",
    "ROS_V18.TF",
    "ROS_SA_2004_V0001.BC",
    "ROS_SA_2005_V0001.BC",
    "ROS_SA_2006_V0001.BC",
    "ROS_SA_2007_V0001.BC",
    "ROS_SA_2008_V0038.BC",
    "ROS_SA_2009_V0054.BC",
    "ROS_SA_2010_V0052.BC",
    "ROS_SA_2011_V0013.BC",
    "ROS_HGA_2008_V0018.BC",
    "ROS_HGA_2009_V0051.BC",

```

"ROS_HGA_2010_V0045.BC",
"ROS_HGA_2011_V0009.BC",
"ROS_RPC_V15.TI",
"NAIF0010.TLS",
"PCK00010.TPC",
"DE403-MASSES.TPC",
"ROS_110405_STEP.TSC",
"ORER_____00031.BSP",
"ORFR_____00067.BSP",
"ORGR_____00096.BSP",
"ORHR_____00122.BSP",
"ORMR_____00052.BSP",
"ORHO_____00077.BSP",
"ROS_RPC_STRUCT_V1.BSP",
"ROS_STRUCT_V2.BSP",
"EARTH_TOPO_050714.TF",
"EARTHFIXEDIAU.TF",
"EARTHFIXEDITRF93.TF",
"RSSD0002.TF",
"LUTETIA_CSEQ.TF",
"ROS_LUTETIA_RSOC_V01.TF",
"EARTH_000101_060918_060627.BPC",
"ROS_LUTETIA_LC1_V02.TPC",
"ROS_LUTETIA_LC2_V02.TPC",
"ROS_LUTETIA_R1_V02.TPC",
"ROS_LUTETIA_R2_V02.TPC",
"ROS_LUTETIA_RSOC_V03.TPC",
"DE405.BSP",
"DSNSTNS.BSP",
"ORHS_____00109.BSP"}

PRODUCER_ID = "RPC_MAG_TEAM"
PRODUCER_FULL_NAME = "INGO RICHTER"
PRODUCER_INSTITUTION_NAME = "IGEP-TU-BRAUNSCHWEIG"
DATA_QUALITY_ID = "N/A"
DATA_QUALITY_DESC = "
ONLY 'GOOD' RAW DATA HAVE BEEN PROCESSED AND STORED"
PROCESSING_LEVEL_ID = "3"

DESCRIPTION = "
THIS FILE CONTAINS CALIBRATED MAGNETIC FIELD VECTOR DATA OBTAINED BY THE
OUTBOARD MAGNETOMETER ABOARD THE ROSETTA S/C AND THE TEMPERATURE OF THE
OUTBOARD SENSOR. GROUND CALIBRATION RESULTS HAVE BEEN APPLIED TO THE RAW
DATA. FIELD IS GIVEN IN INSTRUMENT-COORDINATES"
FLIGHT_SOFTWARE_VERSION_ID = "FIL:V1.0"
PLATFORM_OR_MOUNTING_DESC = "MAGNETOMETER_BOOM: DEPLOYED"

NOTE = "

- a)
MAGNETIC_COORDINATE_SYSTEM : INSTRUMENTCOORDS
- b)
THE VALUES OF THE KEYWORDS SC_SUN_POSITION_VECTOR,
SC_TARGET_POSITION_VECTOR AND SC_TARGET_VELOCITY_VECTOR,
ARE RELATED TO THE ECLIPJ2000 REFERENCE FRAME.
SUB_SPACECRAFT_LATITUDE AND SUB_SPACECRAFT_LONGITUDE
ARE NORTHERN LATITUDE AND EASTERN LONGITUDE IN THE STANDARD
PLANETOCENTRIC IAU <TARGET_NAME> FRAME. ALL VALUES ARE COMPUTED
FOR THE TIME T= START_TIME.
DISTANCES ARE GIVEN IN <KM> VELOCITIES IN <KM/S>, ANGLES IN <DEG>
- c)

LBL & TAB FILE HAVE BEEN GENERATED BY S/W: GEN_CAL_DATA, VERSION V20101210

d)

GROUND CALIBRATION FILE: RPCMAG_GND_CALIB_FSDPU_FMOB.TXT

e)

INFLIGHT CALIBRATION FILE: RPCMAG_100707_006_CALIB_OB.TXT

f)

TIMESTAMPS (UTC) OF PRIMARY SENSOR VECTORS HAVE BEEN SHIFTED BY 8.20 S AND
TIMESTAMPS (UTC) OF SECONDARY SENSOR VECTORS HAVE BEEN SHIFTED BY 31.95 S
IN ORDER TO CORRECT DIGITAL FILTER TRANSFER FUNCTION.

"

^TABLE = "RPCMAG100707T1610_CLA_OB_M2.TAB"

OBJECT = TABLE
NAME = "RPCMAG-OB-SID2-CLA"
INTERCHANGE_FORMAT = ASCII
ROWS = 2976
COLUMNS = 7
ROW_BYTES = 90

OBJECT = COLUMN
NAME = "TIME.UTC"
DATA_TYPE = TIME
START_BYTE = 1
BYTES = 26
DESCRIPTION = "UTC TIME OF OBSERVATION: YYYY-MM-DDTHH:MM:SS.FFFFFFFF"
END_OBJECT = COLUMN

OBJECT = COLUMN
NAME = "TIME.OBT"
DATA_TYPE = ASCII_REAL
START_BYTE = 28
BYTES = 15
DESCRIPTION = "S/C CLOCK AT OBSERVATION TIME, SECONDS SINCE 00:00
AT 1.1.2003: SSSSSSSS.FFFFFF"
END_OBJECT = COLUMN

OBJECT = COLUMN
NAME = "BX.OB"
DATA_TYPE = ASCII_REAL
START_BYTE = 44
BYTES = 9
UNIT = "NANOTESLA"
UNIT_ID = "nT"
DESCRIPTION = "MAGNETIC FIELD X COMPONENT, CALIBRATED, TEMPERATURE
CORRECTED DATA, INSTRUMENT-COORDINATES, OB SENSOR"
END_OBJECT = COLUMN

OBJECT = COLUMN
NAME = "BY.OB"
DATA_TYPE = ASCII_REAL
START_BYTE = 54
BYTES = 9
UNIT = "NANOTESLA"
UNIT_ID = "nT"
DESCRIPTION = "MAGNETIC FIELD Y COMPONENT, CALIBRATED, TEMPERATURE
CORRECTED DATA, INSTRUMENT-COORDINATES, OB SENSOR"
END_OBJECT = COLUMN

OBJECT = COLUMN
NAME = "BZ.OB"

```
DATA_TYPE      = ASCII_REAL
START_BYTE     = 64
BYTES          = 9
UNIT           = "NANOTESLA"
UNIT_ID        = "nT"
DESCRIPTION    = "MAGNETIC FIELD Z COMPONENT, CALIBRATED, TEMPERATURE
CORRECTED DATA, INSTRUMENT-COORDINATES, OB SENSOR"
END_OBJECT     = COLUMN
```

```
OBJECT         = COLUMN
NAME           = "T_OB"
DATA_TYPE      = ASCII_REAL
START_BYTE     = 74
BYTES          = 6
UNIT           = "KELVIN"
UNIT_ID        = "K"
DESCRIPTION    = "TEMPERATURE OF RPCMAG OB SENSOR"
END_OBJECT     = COLUMN
```

```
OBJECT         = COLUMN
NAME           = "QUALITY_FLAGS"
DATA_TYPE      = CHARACTER
START_BYTE     = 81
BYTES          = 8
DESCRIPTION    = "
```

These flags describe the quality of the magnetic field data.
The quality is coded in a 8 byte string. Each character can have
the following values:

VALUE:	MEANING:
x	property described by flag is still unknown
0	no disturbance, good quality
1..9	specific disturbance/problems, see below

Description of the specific flags:

FLAG-STRING FLAG DESCRIPTION

```
87654321
:::----- 1 IMPACT OF REACTION WHEELS
:::      x = impact not assessed
:::      0 = no disturbance
:::      1 = disturbance eliminated during data analysis
:::      2 = disturbance elimination failed
:::      3 = data disturbed
:::----- 2 IMPACT OF LANDER HEATER CURRENTS:
:::      x = impact not assessed
:::      0 = no disturbance
:::      1 = disturbance eliminated during data analysis
:::      2 = disturbance elimination failed
:::      3 = data disturbed
:::----- 3 BOOM DEPLOYMENT:
:::      0 = boom deployed
:::      1 = boom stowed
:::      2 = boom deployment ongoing. Data only valid in
:::          instrument coordinates
:::      3 = pyros fired for boom release
:::----- 4 OFFSET/RESIDUAL-FIELD RELATED EFFECTS:
:::      x = offset/residual-field issues not assessed
```

```

::: 0 = no offset/residual-field problems
::: 1 = offset/residual-field behavior not clear
::: 2 = offset drifts, sensor not in thermal
::: equilibrium thus temperature model N/A
::: 3 = offset/residual-field drifts, reason unknown
::: 4 = /residual-field jump detected, reason unknown
:::
:::----- 5 CORRELATION BETWEEN IB AND OB SENSOR
::: x = correlation not assessed
::: 0 = perfect correlation
::: 1 = good correlation
::: 2 = poor correlation
::: 3 = IB and OB show different long term behavior
:::
:::----- 6 OTHER IMPACTS DECREASING THE QUALITY
::: x = no assessment
::: 0 = no other problems detected
::: 1 = TBD
::: 2 = TBD
::: 3 = TBD
::: 4 = data disturbed by pulses originated in s/c
::: 5 = data disturbed by AC signal originated in s/c
::: 6 = data noisy due to power on failure
::: 7 = data not calculatable due to thermistor failure
::: 8 = sensor saturated due to huge external field
::: 9 = sensor saturated, instrument power on sequence failed
:::
:::----- 7 TBD
::: x = no assessment
:::----- 8 TBD
::: x = no assessment
"
END_OBJECT      = COLUMN
END_OBJECT      = TABLE
END

```

4.3.6 Data Product "CALIBRATED LEVEL_B Magnetic Field data" Design

```

PDS_VERSION_ID      = PDS3
LABEL_REVISION_NOTE = "V1.0"
RECORD_TYPE         = FIXED_LENGTH
RECORD_BYTES        = 90
FILE_RECORDS        = 2976
DATA_SET_ID         = "RO-A-RPCMAG-3-AST2-CALIBRATED-V3.0"
DATA_SET_NAME       = "ROSETTA-ORBITER LUTETIA RPCMAG 3 AST2 CALIBRATED V3.0"
PRODUCT_ID          = "RPCMAG100707T1610_CLB_OB_M2"
PRODUCT_CREATION_TIME = 2012-06-19T12:50:00
PRODUCT_TYPE        = "RDR"
MISSION_ID          = "ROSETTA"
MISSION_NAME        = "INTERNATIONAL ROSETTA MISSION"
MISSION_PHASE_NAME  = "LUTETIA FLY-BY"
OBSERVATION_TYPE    = "LUTETIA FLYBY"

```

```

INSTRUMENT_HOST_ID           = "RO"
INSTRUMENT_HOST_NAME        = "ROSETTA-ORBITER"
INSTRUMENT_ID               = "RPCMAG"
INSTRUMENT_NAME             = "ROSETTA PLASMA CONSORTIUM - FLUXGATE MAGNETOMETER"
INSTRUMENT_TYPE             = "MAGNETOMETER"
INSTRUMENT_MODE_ID         = "SID2"
INSTRUMENT_MODE_DESC       = "
  NORMAL MODE: 32 PRIMARY & 1 SECONDARY VECTORS PER 32 SECONDS"
TARGET_NAME                 = "21 LUTETIA"
TARGET_TYPE                 = "ASTEROID"
START_TIME                  = 2010-07-07T16:10:42.962
STOP_TIME                   = 2010-07-07T17:00:20.896
SPACECRAFT_CLOCK_START_COUNT = "1/237139793.53975"
SPACECRAFT_CLOCK_STOP_COUNT = "1/237142771.49676"

START_JULIAN_DATE_VALUE     = 2455385.1741083572
STOP_JULIAN_DATE_VALUE     = 2455385.2085751859
SC_SUN_POSITION_VECTOR     = ( 398356002.66, 61201421.33, -20680692.79)
SC_TARGET_POSITION_VECTOR  = ( -3861768.74, 110578.75, 59987.88)
SC_TARGET_VELOCITY_VECTOR  = ( 14.99, -0.44, -0.23)
SPACECRAFT_ALTITUDE        = 3863760.134
SUB_SPACECRAFT_LATITUDE    = "N/A"
SUB_SPACECRAFT_LONGITUDE   = "N/A"
SPICE_FILE_NAME            = {"ATNR_P040302093352_00125.BC",
  "ROS_LBOOM_V0.BC",
  "ROS_V18.TF",
  "ROS_SA_2004_V0001.BC",
  "ROS_SA_2005_V0001.BC",
  "ROS_SA_2006_V0001.BC",
  "ROS_SA_2007_V0001.BC",
  "ROS_SA_2008_V0038.BC",
  "ROS_SA_2009_V0054.BC",
  "ROS_SA_2010_V0052.BC",
  "ROS_SA_2011_V0013.BC",
  "ROS_HGA_2008_V0018.BC",
  "ROS_HGA_2009_V0051.BC",
  "ROS_HGA_2010_V0045.BC",
  "ROS_HGA_2011_V0009.BC",
  "ROS_RPC_V15.TI",
  "NAIF0010.TLS",
  "PCK00010.TPC",
  "DE403-MASSES.TPC",
  "ROS_110405_STEP.TSC",
  "ORER_____00031.BSP",
  "ORFR_____00067.BSP",
  "ORGR_____00096.BSP",
  "ORHR_____00122.BSP",
  "ORMR_____00052.BSP",
  "ORHO_____00077.BSP",
  "ROS_RPC_STRUCT_V1.BSP",
  "ROS_STRUCT_V2.BSP",
  "EARTH_TOPO_050714.TF",
  "EARTHFIXEDIAU.TF",
  "EARTHFIXEDITRF93.TF",
  "RSSD0002.TF",
  "LUTETIA_CSEQ.TF",
  "ROS_LUTETIA_RSOC_V01.TF",
  "EARTH_000101_060918_060627.BPC",
  "ROS_LUTETIA_LC1_V02.TPC",
  "ROS_LUTETIA_LC2_V02.TPC",

```

"ROS_LUTETIA_R1_V02.TPC",
"ROS_LUTETIA_R2_V02.TPC",
"ROS_LUTETIA_RSOC_V03.TPC",
"DE405.BSP",
"DSNSTNS.BSP",
"ORHS_____00109.BSP"}

PRODUCER_ID = "RPC_MAG_TEAM"
PRODUCER_FULL_NAME = "INGÖ RICHTER"
PRODUCER_INSTITUTION_NAME = "IGEP-TU-BRAUNSCHWEIG"
DATA_QUALITY_ID = "N/A"
DATA_QUALITY_DESC = "
ONLY 'GOOD' RAW DATA HAVE BEEN PROCESSED AND STORED"
PROCESSING_LEVEL_ID = "3"

DESCRIPTION = "
THIS FILE CONTAINS CALIBRATED MAGNETIC FIELD VECTOR DATA OBTAINED BY THE
OUTBOARD MAGNETOMETER ABOARD THE ROSETTA S/C AND THE TEMPERATURE OF THE
OUTBOARD SENSOR. GROUND CALIBRATION RESULTS HAVE BEEN APPLIED TO THE RAW
DATA. FIELD IS GIVEN IN S/C-COORDINATES"
FLIGHT SOFTWARE_VERSION_ID = "FIL:V1.0"
PLATFORM_OR_MOUNTING_DESC = "MAGNETOMETER_BOOM: DEPLOYED"

NOTE = "
a)
MAGNETIC_COORDINATE_SYSTEM : S/C-COORDS
b)
THE VALUES OF THE KEYWORDS SC_SUN_POSITION_VECTOR,
SC_TARGET_POSITION_VECTOR AND SC_TARGET_VELOCITY_VECTOR,
ARE RELATED TO THE ECLIPJ2000 REFERENCE FRAME.
SUB_SPACECRAFT_LATITUDE AND SUB_SPACECRAFT_LONGITUDE
ARE NORTHERN LATITUDE AND EASTERN LONGITUDE IN THE STANDARD
PLANETOCENTRIC IAU <TARGET_NAME> FRAME. ALL VALUES ARE COMPUTED
FOR THE TIME T= START_TIME.
DISTANCES ARE GIVEN IN <KM> VELOCITIES IN <KM/S>, ANGLES IN <DEG>
c)
LBL & TAB FILE HAVE BEEN GENERATED BY S/W: GEN_CAL_DATA, VERSION V20101210
d)
GROUND CALIBRATION FILE: RPCMAG_GND_CALIB_FSDPU_FMOB.TXT
e)
INFLIGHT CALIBRATION FILE: RPCMAG_100707_006_CALIB_OB.TXT
f)
TIMESTAMPS (UTC) OF PRIMARY SENSOR VECTORS HAVE BEEN SHIFTED BY 8.20 S AND
TIMESTAMPS (UTC) OF SECONDARY SENSOR VECTORS HAVE BEEN SHIFTED BY 31.95 S
IN ORDER TO CORRECT DIGITAL FILTER TRANSFER FUNCTION.

^TABLE = "RPCMAG100707T1610_CLB_OB_M2.TAB"

OBJECT = TABLE
NAME = "RPCMAG-OB-SID2-CLB"
INTERCHANGE_FORMAT = ASCII
ROWS = 2976
COLUMNS = 7
ROW_BYTES = 90

OBJECT = COLUMN
NAME = "TIME.UTC"
DATA_TYPE = TIME
START_BYTE = 1
BYTES = 26

DESCRIPTION = "UTC TIME OF OBSERVATION: YYYY-MM-DDTHH:MM:SS.FFFFFFFF"
END_OBJECT = COLUMN

OBJECT = COLUMN
NAME = "TIME_OBT"
DATA_TYPE = ASCII_REAL
START_BYTE = 28
BYTES = 15
DESCRIPTION = "S/C CLOCK AT OBSERVATION TIME, SECONDS SINCE 00:00
AT 1.1.2003: SSSSSSSS.FFFFFF"
END_OBJECT = COLUMN

OBJECT = COLUMN
NAME = "BX_OB"
DATA_TYPE = ASCII_REAL
START_BYTE = 44
BYTES = 9
UNIT = "NANOTESLA"
UNIT_ID = "nT"
DESCRIPTION = "MAGNETIC FIELD X COMPONENT, CALIBRATED, TEMPERATURE
CORRECTED DATA, S/C-COORDINATES, OB SENSOR"
END_OBJECT = COLUMN

OBJECT = COLUMN
NAME = "BY_OB"
DATA_TYPE = ASCII_REAL
START_BYTE = 54
BYTES = 9
UNIT = "NANOTESLA"
UNIT_ID = "nT"
DESCRIPTION = "MAGNETIC FIELD Y COMPONENT, CALIBRATED, TEMPERATURE
CORRECTED DATA, S/C-COORDINATES, OB SENSOR"
END_OBJECT = COLUMN

OBJECT = COLUMN
NAME = "BZ_OB"
DATA_TYPE = ASCII_REAL
START_BYTE = 64
BYTES = 9
UNIT = "NANOTESLA"
UNIT_ID = "nT"
DESCRIPTION = "MAGNETIC FIELD Z COMPONENT, CALIBRATED, TEMPERATURE
CORRECTED DATA, S/C-COORDINATES, OB SENSOR"
END_OBJECT = COLUMN

OBJECT = COLUMN
NAME = "T_OB"
DATA_TYPE = ASCII_REAL
START_BYTE = 74
BYTES = 6
UNIT = "KELVIN"
UNIT_ID = "K"
DESCRIPTION = "TEMPERATURE OF RPCMAG OB SENSOR"
END_OBJECT = COLUMN

OBJECT = COLUMN
NAME = "QUALITY_FLAGS"
DATA_TYPE = CHARACTER
START_BYTE = 81
BYTES = 8

```

::          8 = sensor saturated due to huge external field
::          9 = sensor saturated, instrument power on sequence failed
::
::----- 7 TBD
:          x = no assessment
:----- 8 TBD
:          x = no assessment
"
END_OBJECT      = COLUMN
END_OBJECT      = TABLE
END

```

4.3.7 Data Product "CALIBRATED LEVEL_C Magnetic Field data" Design

```

PDS_VERSION_ID          = PDS3
LABEL_REVISION_NOTE     = "V1.0"
RECORD_TYPE             = FIXED_LENGTH
RECORD_BYTES            = 125
FILE_RECORDS            = 93
DATA_SET_ID             = "RO-A-RPCMAG-3-AST2-CALIBRATED-V3.0"
DATA_SET_NAME = "ROSETTA-ORBITER LUTETIA RPCMAG 3 AST2 CALIBRATED V3.0"
PRODUCT_ID              = "RPCMAG100707T1610_CLC_IB_M2"
PRODUCT_CREATION_TIME   = 2012-06-19T12:50:00
PRODUCT_TYPE            = "RDR"
MISSION_ID              = "ROSETTA"
MISSION_NAME            = "INTERNATIONAL ROSETTA MISSION"
MISSION_PHASE_NAME     = "LUTETIA FLY-BY"
OBSERVATION_TYPE       = "LUTETIA FLYBY"
INSTRUMENT_HOST_ID     = "RO"
INSTRUMENT_HOST_NAME   = "ROSETTA-ORBITER"
INSTRUMENT_ID          = "RPCMAG"
INSTRUMENT_NAME = "ROSETTA PLASMA CONSORTIUM - FLUXGATE MAGNETOMETER"
INSTRUMENT_TYPE        = "MAGNETOMETER"
INSTRUMENT_MODE_ID     = "SID2"
INSTRUMENT_MODE_DESC   = "
NORMAL MODE: 32 PRIMARY & 1 SECONDARY VECTORS PER 32 SECONDS"
TARGET_NAME            = "21 LUTETIA"
TARGET_TYPE            = "ASTEROID"
START_TIME              = 2010-07-07T16:11:06.712
STOP_TIME               = 2010-07-07T17:00:13.617
COORDINATE_SYSTEM_CENTER_NAME = "LUTETIA"
SPACECRAFT_CLOCK_START_COUNT = "1/237139793.53975"
SPACECRAFT_CLOCK_STOP_COUNT = "1/237142740.47748"

START_JULIAN_DATE_VALUE = 2455385.1743832412
STOP_JULIAN_DATE_VALUE  = 2455385.2084909379
SC_SUN_POSITION_VECTOR  = ( 398356253.91, 61201799.52, -20680689.44)
SC_TARGET_POSITION_VECTOR = ( -3861412.74, 110568.28, 59982.41)
SC_TARGET_VELOCITY_VECTOR = ( 14.99, -0.44, -0.23)
SPACECRAFT_ALTITUDE     = 3863403.905
SUB_SPACECRAFT_LATITUDE = "N/A"
SUB_SPACECRAFT_LONGITUDE = "N/A"
SPICE_FILE_NAME         = {"ATNR_P040302093352_00125.BC",
"ROS_LBOOM_V0.BC",
"ROS_V18.TF",

```

```
"ROS_SA_2004_V0001.BC",
"ROS_SA_2005_V0001.BC",
"ROS_SA_2006_V0001.BC",
"ROS_SA_2007_V0001.BC",
"ROS_SA_2008_V0038.BC",
"ROS_SA_2009_V0054.BC",
"ROS_SA_2010_V0052.BC",
"ROS_SA_2011_V0013.BC",
"ROS_HGA_2008_V0018.BC",
"ROS_HGA_2009_V0051.BC",
"ROS_HGA_2010_V0045.BC",
"ROS_HGA_2011_V0009.BC",
"ROS_RPC_V15.TI",
"NAIF0010.TLS",
"PCK00010.TPC",
"DE403-MASSES.TPC",
"ROS_110405_STEP.TSC",
"ORER_____00031.BSP",
"ORFR_____00067.BSP",
"ORGR_____00096.BSP",
"ORHR_____00122.BSP",
"ORMR_____00052.BSP",
"ORHO_____00077.BSP",
"ROS_RPC_STRUCT_V1.BSP",
"ROS_STRUCT_V2.BSP",
"EARTH_TOPO_050714.TF",
"EARTHFIXEDIAU.TF",
"EARTHFIXEDITRF93.TF",
"RSSD0002.TF",
"LUTETIA_CSEQ.TF",
"ROS_LUTETIA_RSOC_V01.TF",
"EARTH_000101_060918_060627.BPC",
"ROS_LUTETIA_LC1_V02.TPC",
"ROS_LUTETIA_LC2_V02.TPC",
"ROS_LUTETIA_R1_V02.TPC",
"ROS_LUTETIA_R2_V02.TPC",
"ROS_LUTETIA_RSOC_V03.TPC",
"DE405.BSP",
"DSNSTNS.BSP",
"ORHS_____00109.BSP"}
```

```
PRODUCER_ID = "RPC_MAG_TEAM"
PRODUCER_FULL_NAME = "INGO RICHTER"
PRODUCER_INSTITUTION_NAME = "IGEP-TU-BRAUNSCHWEIG"
DATA_QUALITY_ID = "N/A"
DATA_QUALITY_DESC = "
  ONLY 'GOOD' RAW DATA HAVE BEEN PROCESSED AND STORED"
PROCESSING_LEVEL_ID = "3"
```

```
DESCRIPTION = "
  THIS FILE CONTAINS CALIBRATED MAGNETIC FIELD VECTOR DATA OBTAINED BY THE
  INBOARD MAGNETOMETER ABOARD THE ROSETTA S/C. GROUND CALIBRATION RESULTS HAVE
  BEEN APPLIED TO THE RAW DATA. FIELD IS ROTATED TO S/C-COORDS COORDINATES.
  THE S/C POSITION IS GIVEN IN S/C-COORDS COORDINATES AS WELL."
FLIGHT_SOFTWARE_VERSION_ID = "FIL:V1.0"
PLATFORM_OR_MOUNTING_DESC = "MAGNETOMETER_BOOM: DEPLOYED"
```

```
NOTE = "
a)
  MAGNETIC_COORDINATE_SYSTEM : S/C-COORDS
```

b)

THE VALUES OF THE KEYWORDS SC_SUN_POSITION_VECTOR,
SC_TARGET_POSITION_VECTOR AND SC_TARGET_VELOCITY_VECTOR,
ARE RELATED TO THE ECLIPJ2000 REFERENCE FRAME.
SUB_SPACECRAFT_LATITUDE AND SUB_SPACECRAFT_LONGITUDE
ARE NORTHERN LATITUDE AND EASTERN LONGITUDE IN THE STANDARD
PLANETOCENTRIC IAU <TARGET_NAME> FRAME. ALL VALUES ARE COMPUTED
FOR THE TIME T= START_TIME.
DISTANCES ARE GIVEN IN <KM> VELOCITIES IN <KM/S>, ANGLES IN <DEG>

c)

LBL & TAB FILE HAVE BEEN GENERATED BY S/W: GEN_CAL_DATA, VERSION V20101210

d)

S/C ATTITUDE COMPUTED USING FILE ATNR_FDLRMA_DAP040302093352_00107.ROS

e)

S/C POSITION COMPUTED USING FILE ORHS_FDLRMA_DA_____00107.ROS

f)

GROUND CALIBRATION FILE: RPCMAG_GND_CALIB_FSDPU_FMIB.TXT

g)

INFLIGHT CALIBRATION FILE: RPCMAG_100707_006_CALIB_IB.TXT

h)

TIMESTAMPS (UTC) OF PRIMARY SENSOR VECTORS HAVE BEEN SHIFTED BY 8.20 S AND
TIMESTAMPS (UTC) OF SECONDARY SENSOR VECTORS HAVE BEEN SHIFTED BY 31.95 S
IN ORDER TO CORRECT DIGITAL FILTER TRANSFER FUNCTION.

```

^TABLE                = "RPCMAG100707T1610_CLC_IB_M2.TAB"

OBJECT                = TABLE
NAME                  = "RPCMAG-IB-SID2-CLC"
INTERCHANGE_FORMAT   = ASCII
ROWS                  = 93
COLUMNS              = 9
ROW_BYTES             = 125

OBJECT                = COLUMN
NAME                  = "TIME.UTC"
DATA_TYPE             = TIME
START_BYTE            = 1
BYTES                 = 26
DESCRIPTION            = "UTC TIME OF OBSERVATION: YYYY-MM-DDTHH:MM:SS.FFFFFFFF"
END_OBJECT            = COLUMN

OBJECT                = COLUMN
NAME                  = "TIME.OBT"
DATA_TYPE             = ASCII_REAL
START_BYTE            = 28
BYTES                 = 15
DESCRIPTION            = "S/C CLOCK AT OBSERVATION TIME, SECONDS SINCE 00:00 AT
1.1.2003: SSSSSSSS.FFFFFF"
END_OBJECT            = COLUMN

OBJECT                = COLUMN
NAME                  = "POSITION.X"
DATA_TYPE             = ASCII_REAL
START_BYTE            = 44
BYTES                 = 13
UNIT                  = "KILOMETER"
UNIT_ID               = "km"
DESCRIPTION            = "SPACECRAFT POSITION, X COMPONENT, S/C-COORDS"
END_OBJECT            = COLUMN

```

```

OBJECT      = COLUMN
NAME        = "POSITION_Y"
DATA_TYPE   = ASCII_REAL
START_BYTE  = 58
BYTES       = 13
UNIT        = "KILOMETER"
UNIT_ID     = "km"
DESCRIPTION = "SPACECRAFT POSITION, Y COMPONENT, S/C-COORDS"
END_OBJECT  = COLUMN

OBJECT      = COLUMN
NAME        = "POSITION_Z"
DATA_TYPE   = ASCII_REAL
START_BYTE  = 72
BYTES       = 13
UNIT        = "KILOMETER"
UNIT_ID     = "km"
DESCRIPTION = "SPACECRAFT POSITION, Z COMPONENT, S/C-COORDS"
END_OBJECT  = COLUMN

OBJECT      = COLUMN
NAME        = "BX_IB"
DATA_TYPE   = ASCII_REAL
START_BYTE  = 86
BYTES       = 9
UNIT        = "NANOTESLA"
UNIT_ID     = "nT"
DESCRIPTION = "MAGNETIC FIELD X COMPONENT, CALIBRATED, TEMPERATURE
CORRECTED DATA, IB SENSOR, S/C-COORDS"
END_OBJECT  = COLUMN

OBJECT      = COLUMN
NAME        = "BY_IB"
DATA_TYPE   = ASCII_REAL
START_BYTE  = 96
BYTES       = 9
UNIT        = "NANOTESLA"
UNIT_ID     = "nT"
DESCRIPTION = "MAGNETIC FIELD Y COMPONENT, CALIBRATED, TEMPERATURE
CORRECTED DATA, IB SENSOR, S/C-COORDS"
END_OBJECT  = COLUMN

OBJECT      = COLUMN
NAME        = "BZ_IB"
DATA_TYPE   = ASCII_REAL
START_BYTE  = 106
BYTES       = 9
UNIT        = "NANOTESLA"
UNIT_ID     = "nT"
DESCRIPTION = "MAGNETIC FIELD Z COMPONENT, CALIBRATED, TEMPERATURE
CORRECTED DATA, IB SENSOR, S/C-COORDS"
END_OBJECT  = COLUMN

OBJECT      = COLUMN
NAME        = "QUALITY_FLAGS"
DATA_TYPE   = CHARACTER
START_BYTE  = 116
BYTES       = 8
DESCRIPTION = "

```

These flags describe the quality of the magnetic field data. The quality is coded in a 8 byte string. Each character can have the following values:

VALUE:	MEANING:
x	property described by flag is still unknown
0	no disturbance, good quality
1..9	specific disturbance/problems, see below

Description of the specific flags:

FLAG-STRING FLAG DESCRIPTION

```

87654321
:::----- 1 IMPACT OF REACTION WHEELS
:::
:::      x = impact not assessed
:::      0 = no disturbance
:::      1 = disturbance eliminated during data analysis
:::      2 = disturbance elimination failed
:::      3 = data disturbed
:::
:::----- 2 IMPACT OF LANDER HEATER CURRENTS:
:::
:::      x = impact not assessed
:::      0 = no disturbance
:::      1 = disturbance eliminated during data analysis
:::      2 = disturbance elimination failed
:::      3 = data disturbed
:::
:::----- 3 BOOM DEPLOYMENT:
:::
:::      0 = boom deployed
:::      1 = boom stowed
:::      2 = boom deployment ongoing. Data only valid in
:::          instrument coordinates
:::      3 = pyros fired for boom release
:::
:::----- 4 OFFSET/RESIDUAL-FIELD RELATED EFFECTS:
:::
:::      x = offset/residual-field issues not assessed
:::      0 = no offset/residual-field problems
:::      1 = offset/residual-field behavior not clear
:::      2 = offset drifts, sensor not in thermal
:::          equilibrium thus temperature model N/A
:::      3 = offset/residual-field drifts, reason unknown
:::      4 = /residual-field jump detected, reason unknown
:::
:::----- 5 CORRELATION BETWEEN IB AND OB SENSOR
:::
:::      x = correlation not assessed
:::      0 = perfect correlation
:::      1 = good correlation
:::      2 = poor correlation
:::      3 = IB and OB show different long term behavior
:::
:::----- 6 OTHER IMPACTS DECREASING THE QUALITY
:::
:::      x = no assessment
:::      0 = no other problems detected
:::      1 = TBD
:::      2 = TBD
:::      3 = TBD
:::      4 = data disturbed by pulses originated in s/c
:::      5 = data disturbed by AC signal originated in s/c
:::      6 = data noisy due to power on failure
:::      7 = data not calculatable due to thermistor failure
:::      8 = sensor saturated due to huge external field

```

```
::          9 = sensor saturated, instrument power on sequence failed
::
::----- 7 TBD
:          x = no assessment
:----- 8 TBD
:          x = no assessment
"
END_OBJECT      = COLUMN
END_OBJECT      = TABLE
END
```

4.3.8 Data Product "RESAMPLED LEVEL_K Magnetic Field data" Design

```

PDS_VERSION_ID           = PDS3
LABEL_REVISION_NOTE      = "V1.0"
RECORD_TYPE              = FIXED_LENGTH
RECORD_BYTES            = 90
FILE_RECORDS            = 77755
DATA_SET_ID              = "RO-E-RPCMAG-4-EAR1-RESAMPLED-V3.0"
DATA_SET_NAME = "ROSETTA-ORBITER EARTH RPCMAG 4 EAR1 RESAMPLED V3.0"
PRODUCT_ID              = "RPCMAG050301T0000_CLK_OB_M2"
PRODUCT_CREATION_TIME    = 2012-06-20T11:00:00
PRODUCT_TYPE            = "REFDR"
MISSION_ID              = "ROSETTA"
MISSION_NAME            = "INTERNATIONAL ROSETTA MISSION"
MISSION_PHASE_NAME      = "EARTH SWING-BY 1"
OBSERVATION_TYPE        = "EARTH SWINGBY 1"
INSTRUMENT_HOST_ID      = "RO"
INSTRUMENT_HOST_NAME    = "ROSETTA-ORBITER"
INSTRUMENT_ID           = "RPCMAG"
INSTRUMENT_NAME = "ROSETTA PLASMA CONSORTIUM - FLUXGATE MAGNETOMETER"
INSTRUMENT_TYPE         = "MAGNETOMETER"
INSTRUMENT_MODE_ID      = "SID2"
INSTRUMENT_MODE_DESC    = "
  NORMAL MODE: 32 PRIMARY & 1 SECONDARY VECTORS PER 32 SECONDS"
TARGET_NAME             = "EARTH"
TARGET_TYPE             = "PLANET"
START_TIME              = 2005-03-01T00:14:40.655
STOP_TIME               = 2005-03-01T23:59:59.499
SPACECRAFT_CLOCK_START_COUNT = "1/68256861.20971"
SPACECRAFT_CLOCK_STOP_COUNT  = "1/68342380.09737"

START_JULIAN_DATE_VALUE = 2453430.5101927668
STOP_JULIAN_DATE_VALUE  = 2453431.4999942021
SC_SUN_POSITION_VECTOR  = ( 141029080.45, -49951700.27, 73686.10)
SC_TARGET_POSITION_VECTOR = ( 1358534.84, -322205.99, 73167.86)
SC_TARGET_VELOCITY_VECTOR = ( -3.85, 0.86, -0.22)
SPACECRAFT_ALTITUDE     = 1391758.930
SUB_SPACECRAFT_LATITUDE = "N/A"
SUB_SPACECRAFT_LONGITUDE = "N/A"
SPICE_FILE_NAME         = {"ATNR_P040302093352_00125.BC",
  "ROS_LBOOM_V0.BC",
  "ROS_V18.TF",
  "ROS_SA_2004_V0001.BC",
  "ROS_SA_2005_V0001.BC",
  "ROS_SA_2006_V0001.BC",
  "ROS_SA_2007_V0001.BC",
  "ROS_SA_2008_V0038.BC",
  "ROS_SA_2009_V0054.BC",
  "ROS_SA_2010_V0052.BC",
  "ROS_SA_2011_V0013.BC",
  "ROS_HGA_2008_V0018.BC",
  "ROS_HGA_2009_V0051.BC",
  "ROS_HGA_2010_V0045.BC",
  "ROS_HGA_2011_V0009.BC",
  "ROS_RPC_V15.TI",
  "NAIF0010.TLS",

```



```
"PCK00010.TPC",
"DE403-MASSES.TPC",
"ROS_110405_STEP.TSC",
"ORER_____00031.BSP",
"ORFR_____00067.BSP",
"ORGR_____00096.BSP",
"ORHR_____00122.BSP",
"ORMR_____00052.BSP",
"ORHO_____00077.BSP",
"ROS_RPC_STRUCT_V1.BSP",
"ROS_STRUCT_V2.BSP",
"EARTH_TOPO_050714.TF",
"EARTHFIXEDIAU.TF",
"EARTHFIXEDITRF93.TF",
"EARTH_000101_060918_060627.BPC",
"DE405.BSP"}
```

```
PRODUCER_ID           = "RPC_MAG_TEAM"
PRODUCER_FULL_NAME    = "INGÖ RICHTER"
PRODUCER_INSTITUTION_NAME = "IGEP-TU-BRAUNSCHWEIG"
DATA_QUALITY_ID       = "N/A"
DATA_QUALITY_DESC     = ""
  ONLY 'GOOD' RAW DATA HAVE BEEN PROCESSED AND STORED"
PROCESSING_LEVEL_ID   = "4"
```

```
DESCRIPTION           = ""
  THIS FILE CONTAINS CALIBRATED MAGNETIC FIELD VECTOR DATA OBTAINED BY THE
  OUTBOARD MAGNETOMETER ABOARD THE ROSETTA S/C AND THE TEMPERATURE OF THE
  OUTBOARD SENSOR. GROUND CALIBRATION RESULTS HAVE BEEN APPLIED TO THE RAW
  DATA. FIELD IS GIVEN IN S/C-COORDINATES. DISTURBANCE OF LANDER HEATERS
  HAS BEEN ELIMINATED"
FLIGHT_SOFTWARE_VERSION_ID = "FIL:V1.0"
PLATFORM_OR_MOUNTING_DESC  = "MAGNETOMETER_BOOM: DEPLOYED"
```

```
NOTE                  = ""
a)
  MAGNETIC_COORDINATE_SYSTEM : S/C-COORDS
b)
  THE VALUES OF THE KEYWORDS SC_SUN_POSITION_VECTOR,
  SC_TARGET_POSITION_VECTOR AND SC_TARGET_VELOCITY_VECTOR,
  ARE RELATED TO THE ECLIPJ2000 REFERENCE FRAME.
  SUB_SPACECRAFT_LATITUDE AND SUB_SPACECRAFT_LONGITUDE
  ARE NORTHERN LATITUDE AND EASTERN LONGITUDE IN THE STANDARD
  PLANETOCENTRIC IAU <TARGET_NAME> FRAME. ALL VALUES ARE COMPUTED
  FOR THE TIME T= START_TIME.
  DISTANCES ARE GIVEN IN <KM> VELOCITIES IN <KM/S>, ANGLES IN <DEG>
c)
  LBL & TAB FILE HAVE BEEN GENERATED BY S/W: GEN_CAL_DATA, VERSION V20101210
d)
  GROUND CALIBRATION FILE: RPCMAG_GND_CALIB_FSDPU_FMOB.TXT
e)
  INFLIGHT CALIBRATION FILE: RPCMAG_002_CALIB_OB.TXT
```

```
^TABLE                = "RPCMAG050301T0000_CLK_OB_M2.TAB"
```

```
OBJECT                = TABLE
NAME                   = "RPCMAG-OB-SID2-CLK"
INTERCHANGE_FORMAT    = ASCII
ROWS                   = 77755
COLUMNS               = 7
```

```

ROW_BYTES           = 90

OBJECT              = COLUMN
NAME                = "TIME.UTC"
DATA_TYPE           = TIME
START_BYTE         = 1
BYTES               = 26
DESCRIPTION         = "UTC TIME OF OBSERVATION: YYYY-MM-DDTHH:MM:SS.FFFFFFFF"
END_OBJECT          = COLUMN

OBJECT              = COLUMN
NAME                = "TIME.OBT"
DATA_TYPE           = ASCII_REAL
START_BYTE         = 28
BYTES               = 15
DESCRIPTION         = "S/C CLOCK AT OBSERVATION TIME,SECONDS SINCE 00:00
  AT 1.1.2003: SSSSSSSSS.FFFFFF"
END_OBJECT          = COLUMN

OBJECT              = COLUMN
NAME                = "BX.OB"
DATA_TYPE           = ASCII_REAL
START_BYTE         = 44
BYTES               = 9
UNIT                = "NANOTESLA"
UNIT_ID             = "nT"
DESCRIPTION         = "MAGNETIC FIELD X COMPONENT, CALIBRATED, TEMPERATURE
  CORRECTED DATA, S/C-COORDINATES, OB SENSOR,
  HEATER DISTURBANCE ELIMINATED"
END_OBJECT          = COLUMN

OBJECT              = COLUMN
NAME                = "BY.OB"
DATA_TYPE           = ASCII_REAL
START_BYTE         = 54
BYTES               = 9
UNIT                = "NANOTESLA"
UNIT_ID             = "nT"
DESCRIPTION         = "MAGNETIC FIELD Y COMPONENT, CALIBRATED, TEMPERATURE
  CORRECTED DATA, S/C-COORDINATES, OB SENSOR,
  HEATER DISTURBANCE ELIMINATED"
END_OBJECT          = COLUMN

OBJECT              = COLUMN
NAME                = "BZ.OB"
DATA_TYPE           = ASCII_REAL
START_BYTE         = 64
BYTES               = 9
UNIT                = "NANOTESLA"
UNIT_ID             = "nT"
DESCRIPTION         = "MAGNETIC FIELD Z COMPONENT, CALIBRATED, TEMPERATURE
  CORRECTED DATA, S/C-COORDINATES, OB SENSOR,
  HEATER DISTURBANCE ELIMINATED"
END_OBJECT          = COLUMN

OBJECT              = COLUMN
NAME                = "T.OB"
DATA_TYPE           = ASCII_REAL
START_BYTE         = 74
BYTES               = 6

```



```

:::----- 6 OTHER IMPACTS DECREASING THE QUALITY
::          x = no assessment
::          0 = no other problems detected
::          1 = TBD
::          2 = TBD
::          3 = TBD
::          4 = data disturbed by pulses originated in s/c
::          5 = data disturbed by AC signal originated in s/c
::          6 = data noisy due to power on failure
::          7 = data not calculatable due to thermistor failure
::          8 = sensor saturated due to huge external field
::          9 = sensor saturated, instrument power on sequence failed
::
:::----- 7 TBD
:          x = no assessment
:----- 8 TBD
:          x = no assessment
"
END_OBJECT      = COLUMN
END_OBJECT      = TABLE
END

```

4.3.9 Data Product "RESAMPLED LEVEL_L Magnetic Field data" Design

```

PDS_VERSION_ID      = PDS3
LABEL_REVISION_NOTE = "V1.0"
RECORD_TYPE          = FIXED_LENGTH
RECORD_BYTES         = 125
FILE_RECORDS         = 77755
DATA_SET_ID          = "RO-E-RPCMAG-4-EAR1-RESAMPLED-V3.0"
DATA_SET_NAME = "ROSETTA-ORBITER EARTH RPCMAG 4 EAR1 RESAMPLED V3.0"
PRODUCT_ID           = "RPCMAG050301T0000_CLL_OB_M2"
PRODUCT_CREATION_TIME = 2012-06-20T11:00:00
PRODUCT_TYPE         = "REFDR"
MISSION_ID           = "ROSETTA"
MISSION_NAME         = "INTERNATIONAL ROSETTA MISSION"
MISSION_PHASE_NAME   = "EARTH SWING-BY 1"
OBSERVATION_TYPE     = "EARTH SWINGBY 1"
INSTRUMENT_HOST_ID   = "RO"
INSTRUMENT_HOST_NAME = "ROSETTA-ORBITER"
INSTRUMENT_ID        = "RPCMAG"
INSTRUMENT_NAME = "ROSETTA PLASMA CONSORTIUM - FLUXGATE MAGNETOMETER"
INSTRUMENT_TYPE      = "MAGNETOMETER"
INSTRUMENT_MODE_ID   = "SID2"
INSTRUMENT_MODE_DESC = "
NORMAL MODE: 32 PRIMARY & 1 SECONDARY VECTORS PER 32 SECONDS"
TARGET_NAME          = "EARTH"
TARGET_TYPE          = "PLANET"

```

START_TIME = 2005-03-01T00:14:40.655
 STOP_TIME = 2005-03-01T23:59:59.499
 COORDINATE_SYSTEM_CENTER_NAME = "SUN"
 SPACECRAFT_CLOCK_START_COUNT = "1/68256861.20971"
 SPACECRAFT_CLOCK_STOP_COUNT = "1/68342380.09737"

START_JULIAN_DATE_VALUE = 2453430.5101927668
 STOP_JULIAN_DATE_VALUE = 2453431.4999942021
 SC_SUN_POSITION_VECTOR = (141029080.45, -49951700.27, 73686.10)
 SC_TARGET_POSITION_VECTOR = (1358534.84, -322205.99, 73167.86)
 SC_TARGET_VELOCITY_VECTOR = (-3.85, 0.86, -0.22)
 SPACECRAFT_ALTITUDE = 1391758.930
 SUB_SPACECRAFT_LATITUDE = "N/A"
 SUB_SPACECRAFT_LONGITUDE = "N/A"
 SPICE_FILE_NAME = {"ATNR_P040302093352_00125.BC",
 "ROS_LBOOM_V0.BC",
 "ROS_V18.TF",
 "ROS_SA_2004_V0001.BC",
 "ROS_SA_2005_V0001.BC",
 "ROS_SA_2006_V0001.BC",
 "ROS_SA_2007_V0001.BC",
 "ROS_SA_2008_V0038.BC",
 "ROS_SA_2009_V0054.BC",
 "ROS_SA_2010_V0052.BC",
 "ROS_SA_2011_V0013.BC",
 "ROS_HGA_2008_V0018.BC",
 "ROS_HGA_2009_V0051.BC",
 "ROS_HGA_2010_V0045.BC",
 "ROS_HGA_2011_V0009.BC",
 "ROS_RPC_V15.TI",
 "NAIF0010.TLS",
 "PCK00010.TPC",
 "DE403-MASSES.TPC",
 "ROS_110405_STEP.TSC",
 "ORER_____00031.BSP",
 "ORFR_____00067.BSP",
 "ORGR_____00096.BSP",
 "ORHR_____00122.BSP",
 "ORMR_____00052.BSP",
 "ORHO_____00077.BSP",
 "ROS_RPC_STRUCT_V1.BSP",
 "ROS_STRUCT_V2.BSP",
 "EARTH_TOPO_050714.TF",
 "EARTHFIXEDIAU.TF",
 "EARTHFIXEDITRF93.TF",
 "EARTH_000101_060918_060627.BPC",
 "DE405.BSP"}

PRODUCER_ID = "RPC_MAG_TEAM"
 PRODUCER_FULL_NAME = "INGO RICHTER"
 PRODUCER_INSTITUTION_NAME = "IGEP-TU-BRAUNSCHWEIG"
 DATA_QUALITY_ID = "N/A"
 DATA_QUALITY_DESC = "
 ONLY 'GOOD' RAW DATA HAVE BEEN PROCESSED AND STORED"
 PROCESSING_LEVEL_ID = "4"

DESCRIPTION = "
 THIS FILE CONTAINS CALIBRATED MAGNETIC FIELD VECTOR DATA OBTAINED BY THE
 OUTBOARD MAGNETOMETER ABOARD THE ROSETTA S/C. GROUND CALIBRATION RESULTS HAVE
 BEEN APPLIED TO THE RAW DATA. FIELD IS ROTATED TO S/C-COORDS COORDINATES.

THE S/C POSITION IS GIVEN IN S/C-COORDS COORDINATES AS WELL. HEATER
 DISTURBANCES HAVE BEEN ELIMINATED"

FLIGHT SOFTWARE_VERSION_ID = "FIL:V1.0"
 PLATFORM_OR_MOUNTING_DESC = "MAGNETOMETER_BOOM: DEPLOYED"

NOTE = "

a)

MAGNETIC_COORDINATE_SYSTEM : S/C-COORDS

b)

THE VALUES OF THE KEYWORDS SC_SUN_POSITION_VECTOR,
 SC_TARGET_POSITION_VECTOR AND SC_TARGET_VELOCITY_VECTOR,
 ARE RELATED TO THE ECLIPJ2000 REFERENCE FRAME.
 SUB_SPACECRAFT_LATITUDE AND SUB_SPACECRAFT_LONGITUDE
 ARE NORTHERN LATITUDE AND EASTERN LONGITUDE IN THE STANDARD
 PLANETOCENTRIC IAU <TARGET_NAME> FRAME. ALL VALUES ARE COMPUTED
 FOR THE TIME T= START_TIME.
 DISTANCES ARE GIVEN IN <KM> VELOCITIES IN <KM/S>, ANGLES IN <DEG>

c)

LBL & TAB FILE HAVE BEEN GENERATED BY S/W: GEN_CAL_DATA, VERSION V20101210

d)

S/C ATTITUDE COMPUTED USING FILE ATNR_FDLRMA_DAP040302093352_00107.ROS

e)

S/C POSITION COMPUTED USING FILE ORHR_FDLRMA_DA_____00107.ROS

f)

GROUND CALIBRATION FILE: RPCMAG_GND_CALIB_FSDPU_FMOB.TXT

g)

INFLIGHT CALIBRATION FILE: RPCMAG_002_CALIB_OB.TXT

"

^TABLE = "RPCMAG050301T0000_CLL_OB_M2.TAB"

OBJECT = TABLE
 NAME = "RPCMAG-OB-SID2-CLL"
 INTERCHANGE_FORMAT = ASCII
 ROWS = 77755
 COLUMNS = 9
 ROW_BYTES = 125

OBJECT = COLUMN
 NAME = "TIME.UTC"
 DATA_TYPE = TIME
 START_BYTE = 1
 BYTES = 26
 DESCRIPTION = "UTC TIME OF OBSERVATION: YYYY-MM-DDTHH:MM:SS.FFFFFFFF"
 END_OBJECT = COLUMN

OBJECT = COLUMN
 NAME = "TIME_OBT"
 DATA_TYPE = ASCII_REAL
 START_BYTE = 28
 BYTES = 15
 DESCRIPTION = "S/C CLOCK AT OBSERVATION TIME, SECONDS SINCE 00:00 AT
 1.1.2003: SSSSSSSS.FFFFFF"
 END_OBJECT = COLUMN

OBJECT = COLUMN
 NAME = "POSITION_X"
 DATA_TYPE = ASCII_REAL
 START_BYTE = 44
 BYTES = 13

```

UNIT          = "KILOMETER"
UNIT_ID       = "km"
DESCRIPTION   = "SPACECRAFT POSITION, X COMPONENT, S/C-COORDS"
END_OBJECT   = COLUMN

OBJECT        = COLUMN
NAME          = "POSITION_Y"
DATA_TYPE     = ASCII_REAL
START_BYTE   = 58
BYTES        = 13
UNIT          = "KILOMETER"
UNIT_ID       = "km"
DESCRIPTION   = "SPACECRAFT POSITION, Y COMPONENT, S/C-COORDS"
END_OBJECT   = COLUMN

OBJECT        = COLUMN
NAME          = "POSITION_Z"
DATA_TYPE     = ASCII_REAL
START_BYTE   = 72
BYTES        = 13
UNIT          = "KILOMETER"
UNIT_ID       = "km"
DESCRIPTION   = "SPACECRAFT POSITION, Z COMPONENT, S/C-COORDS"
END_OBJECT   = COLUMN

OBJECT        = COLUMN
NAME          = "BX_OB"
DATA_TYPE     = ASCII_REAL
START_BYTE   = 86
BYTES        = 9
UNIT          = "NANOTESLA"
UNIT_ID       = "nT"
DESCRIPTION   = "MAGNETIC FIELD X COMPONENT, CALIBRATED, TEMPERATURE
CORRECTED DATA, OB SENSOR, S/C-COORDS,
HEATER DISTURBANCE ELIMINATED"
END_OBJECT   = COLUMN

OBJECT        = COLUMN
NAME          = "BY_OB"
DATA_TYPE     = ASCII_REAL
START_BYTE   = 96
BYTES        = 9
UNIT          = "NANOTESLA"
UNIT_ID       = "nT"
DESCRIPTION   = "MAGNETIC FIELD Y COMPONENT, CALIBRATED, TEMPERATURE
CORRECTED DATA, OB SENSOR, S/C-COORDS,
HEATER DISTURBANCE ELIMINATED"
END_OBJECT   = COLUMN

OBJECT        = COLUMN
NAME          = "BZ_OB"
DATA_TYPE     = ASCII_REAL
START_BYTE   = 106
BYTES        = 9
UNIT          = "NANOTESLA"
UNIT_ID       = "nT"
DESCRIPTION   = "MAGNETIC FIELD Z COMPONENT, CALIBRATED, TEMPERATURE
CORRECTED DATA, OB SENSOR, S/C-COORDS,
HEATER DISTURBANCE ELIMINATED"
END_OBJECT   = COLUMN

```

OBJECT = COLUMN
NAME = "QUALITY_FLAGS"
DATA_TYPE = CHARACTER
START_BYTE = 116
BYTES = 8
DESCRIPTION = "

These flags describe the quality of the magnetic field data.
The quality is coded in a 8 byte string. Each character can have
the following values:

VALUE:	MEANING:
x	property described by flag is still unknown
0	no disturbance, good quality
1..9	specific disturbance/problems, see below

Description of the specific flags:

FLAG-STRING FLAG DESCRIPTION

```
87654321
:::----- 1 IMPACT OF REACTION WHEELS
:::      x = impact not assessed
:::      0 = no disturbance
:::      1 = disturbance eliminated during data analysis
:::      2 = disturbance elimination failed
:::      3 = data disturbed
:::
:::----- 2 IMPACT OF LANDER HEATER CURRENTS:
:::      x = impact not assessed
:::      0 = no disturbance
:::      1 = disturbance eliminated during data analysis
:::      2 = disturbance elimination failed
:::      3 = data disturbed
:::
:::----- 3 BOOM DEPLOYMENT:
:::      0 = boom deployed
:::      1 = boom stowed
:::      2 = boom deployment ongoing. Data only valid in
:::          instrument coordinates
:::      3 = pyros fired for boom release
:::
:::----- 4 OFFSET/RESIDUAL-FIELD RELATED EFFECTS:
:::      x = offset/residual-field issues not assessed
:::      0 = no offset/residual-field problems
:::      1 = offset/residual-field behavior not clear
:::      2 = offset drifts, sensor not in thermal
:::          equilibrium thus temperature model N/A
:::      3 = offset/residual-field drifts, reason unknown
:::      4 = /residual-field jump detected, reason unknown
:::
:::----- 5 CORRELATION BETWEEN IB AND OB SENSOR
:::      x = correlation not assessed
:::      0 = perfect correlation
:::      1 = good correlation
:::      2 = poor correlation
:::      3 = IB and OB show different long term behavior
:::
:::----- 6 OTHER IMPACTS DECREASING THE QUALITY
:::      x = no assessment
:::      0 = no other problems detected
:::      1 = TBD
```



```
::          2 = TBD
::          3 = TBD
::          4 = data disturbed by pulses originated in s/c
::          5 = data disturbed by AC signal originated in s/c
::          6 = data noisy due to power on failure
::          7 = data not calculatable due to thermistor failure
::          8 = sensor saturated due to huge external field
::          9 = sensor saturated, instrument power on sequence failed
::
::----- 7 TBD
:          x = no assessment
:----- 8 TBD
:          x = no assessment
"
END_OBJECT      = COLUMN
END_OBJECT      = TABLE
END
```

4.3.10 Data Product "RESAMPLED LEVEL_F Magnetic Field data" Design

```

PDS_VERSION_ID           = PDS3
LABEL_REVISION_NOTE     = "V1.0"
RECORD_TYPE              = FIXED_LENGTH
RECORD_BYTES             = 90
FILE_RECORDS             = 2915
DATA_SET_ID              = "RO-A-RPCMAG-4-AST2-RESAMPLED-V3.0"
DATA_SET_NAME = "ROSETTA-ORBITER LUTETIA RPCMAG 4 AST2 RESAMPLED V3.0"
PRODUCT_ID               = "RPCMAG100707_CLF_IB_A1"
PRODUCT_CREATION_TIME    = 2012-06-19T12:50:00
PRODUCT_TYPE             = "REFDR"
MISSION_ID               = "ROSETTA"
MISSION_NAME              = "INTERNATIONAL ROSETTA MISSION"
MISSION_PHASE_NAME       = "LUTETIA FLY-BY"
OBSERVATION_TYPE         = "LUTETIA FLYBY"
INSTRUMENT_HOST_ID       = "RO"
INSTRUMENT_HOST_NAME     = "ROSETTA-ORBITER"
INSTRUMENT_ID            = "RPCMAG"
INSTRUMENT_NAME = "ROSETTA PLASMA CONSORTIUM - FLUXGATE MAGNETOMETER"
INSTRUMENT_TYPE          = "MAGNETOMETER"
INSTRUMENT_MODE_ID       = "AVERAGED"
INSTRUMENT_MODE_DESC     = "1 S AVERAGES"
TARGET_NAME              = "21 LUTETIA"
TARGET_TYPE              = "ASTEROID"
START_TIME               = 2010-07-07T16:11:07.212
STOP_TIME                = 2010-07-07T16:59:41.212
SPACECRAFT_CLOCK_START_COUNT = "1/237139794.03975"
SPACECRAFT_CLOCK_STOP_COUNT  = "1/237142708.03975"

START_JULIAN_DATE_VALUE   = 2455385.1743890285
STOP_JULIAN_DATE_VALUE   = 2455385.2081158804
SC_SUN_POSITION_VECTOR    = ( 398356259.20, 61201807.49, -20680689.37)
SC_TARGET_POSITION_VECTOR = ( -3861405.25, 110568.06, 59982.29)
SC_TARGET_VELOCITY_VECTOR = ( 14.99, -0.44, -0.23)
SPACECRAFT_ALTITUDE       = 3863396.405
SUB_SPACECRAFT_LATITUDE   = "N/A"
SUB_SPACECRAFT_LONGITUDE  = "N/A"
SPACE_FILE_NAME           = {"ATNR_P040302093352_00125.BC",
                             "ROS_LBOOM_V0.BC",
                             "ROS_V18.TF",
                             "ROS_SA_2004_V0001.BC",
                             "ROS_SA_2005_V0001.BC",
                             "ROS_SA_2006_V0001.BC",
                             "ROS_SA_2007_V0001.BC",
                             "ROS_SA_2008_V0038.BC",
                             "ROS_SA_2009_V0054.BC",
                             "ROS_SA_2010_V0052.BC",
                             "ROS_SA_2011_V0013.BC",
                             "ROS_HGA_2008_V0018.BC",
                             "ROS_HGA_2009_V0051.BC",
                             "ROS_HGA_2010_V0045.BC",
                             "ROS_HGA_2011_V0009.BC",
                             "ROS_RPC_V15.TI",
                             "NAIF0010.TLS",

```

"PCK00010.TPC",
"DE403-MASSES.TPC",
"ROS_110405_STEP.TSC",
"ORER_____00031.BSP",
"ORFR_____00067.BSP",
"ORGR_____00096.BSP",
"ORHR_____00122.BSP",
"ORMR_____00052.BSP",
"ORHO_____00077.BSP",
"ROS_RPC_STRUCT_V1.BSP",
"ROS_STRUCT_V2.BSP",
"EARTH_TOPO_050714.TF",
"EARTHFIXEDIAU.TF",
"EARTHFIXEDITRF93.TF",
"RSSD0002.TF",
"LUTETIA_CSEQ.TF",
"ROS_LUTETIA_RSOC_V01.TF",
"EARTH_000101_060918_060627.BPC",
"ROS_LUTETIA_LC1_V02.TPC",
"ROS_LUTETIA_LC2_V02.TPC",
"ROS_LUTETIA_R1_V02.TPC",
"ROS_LUTETIA_R2_V02.TPC",
"ROS_LUTETIA_RSOC_V03.TPC",
"DE405.BSP",
"DSNSTNS.BSP",
"ORHS_____00109.BSP"}

PRODUCER_ID = "RPC_MAG_TEAM"
PRODUCER_FULL_NAME = "INGO RICHTER"
PRODUCER_INSTITUTION_NAME = "IGEP-TU-BRAUNSCHWEIG"
DATA_QUALITY_ID = "N/A"
DATA_QUALITY_DESC = "
ONLY 'GOOD' RAW DATA HAVE BEEN PROCESSED AND STORED"
PROCESSING_LEVEL_ID = "4"

DESCRIPTION = "
THIS FILE CONTAINS CALIBRATED MAGNETIC FIELD VECTOR DATA OBTAINED BY THE
INBOARD MAGNETOMETER ABOARD THE ROSETTA S/C. GROUND CALIBRATION RESULTS HAVE
BEEN APPLIED TO THE RAW DATA. FIELD IS ROTATED TO S/C-COORDS
COORDINATES.DATA ARE AVERAGED TO 1 S MEANS."
FLIGHT SOFTWARE_VERSION_ID = "FIL:V1.0"
PLATFORM_OR_MOUNTING_DESC = "MAGNETOMETER_BOOM: DEPLOYED"

NOTE = "
a)
MAGNETIC_COORDINATE_SYSTEM : S/C-COORDS
b)
THE VALUES OF THE KEYWORDS SC_SUN_POSITION_VECTOR,
SC_TARGET_POSITION_VECTOR AND SC_TARGET_VELOCITY_VECTOR,
ARE RELATED TO THE ECLIPJ2000 REFERENCE FRAME.
SUB_SPACECRAFT_LATITUDE AND SUB_SPACECRAFT_LONGITUDE
ARE NORTHERN LATITUDE AND EASTERN LONGITUDE IN THE STANDARD
PLANETOCENTRIC IAU <TARGET_NAME> FRAME. ALL VALUES ARE COMPUTED
FOR THE TIME T= START_TIME.
DISTANCES ARE GIVEN IN <KM> VELOCITIES IN <KM/S>, ANGLES IN <DEG>
c)
LBL & TAB FILE HAVE BEEN GENERATED BY S/W: GEN_CAL_DATA, VERSION V20101210
d)
GROUND CALIBRATION FILE: RPCMAG_GND_CALIB_FSDPU_FMIB.TXT
e)

INFLIGHT CALIBRATION FILE: RPCMAG_100707_006_CALIB_IB.TXT

f)

DATA SOURCE FOR CLF DATA: LEVEL_B DATA

```

^TABLE          = "RPCMAG100707_CLF_IB_A1.TAB"

OBJECT          = TABLE
NAME            = "RPCMAG-IB-1S_AVERAGE-CLF"
INTERCHANGE_FORMAT = ASCII
ROWS           = 2915
COLUMNS       = 7
ROW_BYTES      = 90

OBJECT          = COLUMN
NAME            = "TIME.UTC"
DATA_TYPE       = TIME
START_BYTE     = 1
BYTES          = 26
DESCRIPTION     = "UTC TIME OF OBSERVATION: YYYY-MM-DDTHH:MM:SS.FFFFFFFF"
END_OBJECT      = COLUMN

OBJECT          = COLUMN
NAME            = "TIME.OBT"
DATA_TYPE       = ASCII_REAL
START_BYTE     = 28
BYTES          = 15
DESCRIPTION     = "S/C CLOCK AT OBSERVATION TIME, SECONDS SINCE 00:00
AT 1.1.2003: SSSSSSSSS.FFFFFF"
END_OBJECT      = COLUMN

OBJECT          = COLUMN
NAME            = "BX_IB"
DATA_TYPE       = ASCII_REAL
START_BYTE     = 44
BYTES          = 9
UNIT           = "NANOTESLA"
UNIT_ID        = "nT"
DESCRIPTION     = "MAGNETIC FIELD X COMPONENT, CALIBRATED,
TEMPERATURE CORRECTED DATA, S/C-COORDINATES, 1S_AVERAGE-IB SENSOR"
END_OBJECT      = COLUMN

OBJECT          = COLUMN
NAME            = "BY_IB"
DATA_TYPE       = ASCII_REAL
START_BYTE     = 54
BYTES          = 9
UNIT           = "NANOTESLA"
UNIT_ID        = "nT"
DESCRIPTION     = "MAGNETIC FIELD Y COMPONENT, CALIBRATED,
TEMPERATURE CORRECTED DATA, S/C-COORDINATES, 1S_AVERAGE-IB SENSOR"
END_OBJECT      = COLUMN

OBJECT          = COLUMN
NAME            = "BZ_IB"
DATA_TYPE       = ASCII_REAL
START_BYTE     = 64
BYTES          = 9
UNIT           = "NANOTESLA"
UNIT_ID        = "nT"
DESCRIPTION     = "MAGNETIC FIELD Z COMPONENT, CALIBRATED,

```

TEMPERATURE CORRECTED DATA, S/C-COORDINATES, 1S_AVERAGE-IB SENSOR"
END_OBJECT = COLUMN

OBJECT = COLUMN
NAME = "T_IB"
DATA_TYPE = ASCII_REAL
START_BYTE = 74
BYTES = 6
UNIT = "KELVIN"
UNIT_ID = "K"
DESCRIPTION = "TEMPERATURE OF RPCMAG IB SENSOR"
END_OBJECT = COLUMN

OBJECT = COLUMN
NAME = "QUALITY_FLAGS"
DATA_TYPE = CHARACTER
START_BYTE = 81
BYTES = 8
DESCRIPTION = "

These flags describe the quality of the magnetic field data.
The quality is coded in a 8 byte string. Each character can have
the following values:

VALUE:	MEANING:
x	property described by flag is still unknown
0	no disturbance, good quality
1..9	specific disturbance/problems, see below

Description of the specific flags:

FLAG-STRING FLAG DESCRIPTION

```
87654321
:::----- 1 IMPACT OF REACTION WHEELS
:::      x = impact not assessed
:::      0 = no disturbance
:::      1 = disturbance eliminated during data analysis
:::      2 = disturbance elimination failed
:::      3 = data disturbed
:::
:::----- 2 IMPACT OF LANDER HEATER CURRENTS:
:::      x = impact not assessed
:::      0 = no disturbance
:::      1 = disturbance eliminated during data analysis
:::      2 = disturbance elimination failed
:::      3 = data disturbed
:::
:::----- 3 BOOM DEPLOYMENT:
:::      0 = boom deployed
:::      1 = boom stowed
:::      2 = boom deployment ongoing. Data only valid in
:::          instrument coordinates
:::      3 = pyros fired for boom release
:::
:::----- 4 OFFSET/RESIDUAL-FIELD RELATED EFFECTS:
:::      x = offset/residual-field issues not assessed
:::      0 = no offset/residual-field problems
:::      1 = offset/residual-field behavior not clear
:::      2 = offset drifts, sensor not in thermal
:::          equilibrium thus temperature model N/A
:::      3 = offset/residual-field drifts, reason unknown
:::      4 = /residual-field jump detected, reason unknown
```

```

::::
::::----- 5 CORRELATION BETWEEN IB AND OB SENSOR
:::          x = correlation not assessed
:::          0 = perfect correlation
:::          1 = good correlation
:::          2 = poor correlation
:::          3 = IB and OB show different long term behavior
:::
:::----- 6 OTHER IMPACTS DECREASING THE QUALITY
:::          x = no assessment
:::          0 = no other problems detected
:::          1 = TBD
:::          2 = TBD
:::          3 = TBD
:::          4 = data disturbed by pulses originated in s/c
:::          5 = data disturbed by AC signal originated in s/c
:::          6 = data noisy due to power on failure
:::          7 = data not calculatable due to thermistor failure
:::          8 = sensor saturated due to huge external field
:::          9 = sensor saturated, instrument power on sequence failed
:::
:::----- 7 TBD
:::          x = no assessment
:::----- 8 TBD
:::          x = no assessment
"
END_OBJECT      = COLUMN
END_OBJECT      = TABLE
END

```

4.3.11 Data Product "RESAMPLED LEVEL_G Magnetic Field data" Design

```

PDS_VERSION_ID      = PDS3
LABEL_REVISION_NOTE = "V1.0"
RECORD_TYPE         = FIXED_LENGTH
RECORD_BYTES        = 125
FILE_RECORDS        = 2977
DATA_SET_ID         = "RO-A-RPCMAG-4-AST2-RESAMPLED-V3.0"
DATA_SET_NAME       = "ROSETTA-ORBITER LUTETIA RPCMAG 4 AST2 RESAMPLED V3.0"
PRODUCT_ID          = "RPCMAG100707_CLG_OB_A1"
PRODUCT_CREATION_TIME = 2012-06-19T12:50:00
PRODUCT_TYPE        = "REFDR"
MISSION_ID           = "ROSETTA"
MISSION_NAME         = "INTERNATIONAL ROSETTA MISSION"
MISSION_PHASE_NAME  = "LUTETIA FLY-BY"
OBSERVATION_TYPE    = "LUTETIA FLYBY"
INSTRUMENT_HOST_ID  = "RO"
INSTRUMENT_HOST_NAME = "ROSETTA-ORBITER"
INSTRUMENT_ID       = "RPCMAG"
INSTRUMENT_NAME     = "ROSETTA PLASMA CONSORTIUM - FLUXGATE MAGNETOMETER"

```

```

INSTRUMENT_TYPE = "MAGNETOMETER"
INSTRUMENT_MODE_ID = "AVERAGED"
INSTRUMENT_MODE_DESC = "1 S AVERAGES"
TARGET_NAME = "21 LUTETIA"
TARGET_TYPE = "ASTEROID"
COORDINATE_SYSTEM_CENTER_NAME = "LUTETIA"
START_TIME = 2010-07-07T16:10:43.462
STOP_TIME = 2010-07-07T17:00:19.462
SPACECRAFT_CLOCK_START_COUNT = "1/237139794.03975"
SPACECRAFT_CLOCK_STOP_COUNT = "1/237142770.03975"

START_JULIAN_DATE_VALUE = 2455385.1741141439
STOP_JULIAN_DATE_VALUE = 2455385.2085585883
SC_SUN_POSITION_VECTOR = ( 398356007.95, 61201429.30, -20680692.72)
SC_TARGET_POSITION_VECTOR = ( -3861761.24, 110578.53, 59987.77)
SC_TARGET_VELOCITY_VECTOR = ( 14.99, -0.44, -0.23)
SPACECRAFT_ALTITUDE = 3863752.634
SUB_SPACECRAFT_LATITUDE = "N/A"
SUB_SPACECRAFT_LONGITUDE = "N/A"
SPICE_FILE_NAME = {"ATNR_P040302093352_00125.BC",
"ROS_LBOOM_V0.BC",
"ROS_V18.TF",
"ROS_SA_2004_V0001.BC",
"ROS_SA_2005_V0001.BC",
"ROS_SA_2006_V0001.BC",
"ROS_SA_2007_V0001.BC",
"ROS_SA_2008_V0038.BC",
"ROS_SA_2009_V0054.BC",
"ROS_SA_2010_V0052.BC",
"ROS_SA_2011_V0013.BC",
"ROS_HGA_2008_V0018.BC",
"ROS_HGA_2009_V0051.BC",
"ROS_HGA_2010_V0045.BC",
"ROS_HGA_2011_V0009.BC",
"ROS_RPC_V15.TI",
"NAIF0010.TLS",
"PCK00010.TPC",
"DE403-MASSES.TPC",
"ROS_110405_STEP.TSC",
"ORER_____00031.BSP",
"ORFR_____00067.BSP",
"ORGR_____00096.BSP",
"ORHR_____00122.BSP",
"ORMR_____00052.BSP",
"ORHO_____00077.BSP",
"ROS_RPC_STRUCT_V1.BSP",
"ROS_STRUCT_V2.BSP",
"EARTH_TOPO_050714.TF",
"EARTHFIXEDIAU.TF",
"EARTHFIXEDITRF93.TF",
"RSSD0002.TF",
"LUTETIA_CSEQ.TF",
"ROS_LUTETIA_RSOC_V01.TF",
"EARTH_000101_060918_060627.BPC",
"ROS_LUTETIA_LC1_V02.TPC",
"ROS_LUTETIA_LC2_V02.TPC",
"ROS_LUTETIA_R1_V02.TPC",
"ROS_LUTETIA_R2_V02.TPC",
"ROS_LUTETIA_RSOC_V03.TPC",
"DE405.BSP",

```

"DSNSTNS.BSP",
"ORHS_____00109.BSP"}

PRODUCER_ID = "RPC_MAG_TEAM"
PRODUCER_FULL_NAME = "INGO RICHTER"
PRODUCER_INSTITUTION_NAME = "IGEP-TU-BRAUNSCHWEIG"
DATA_QUALITY_ID = "N/A"
DATA_QUALITY_DESC = "
ONLY 'GOOD' RAW DATA HAVE BEEN PROCESSED AND STORED"
PROCESSING_LEVEL_ID = "4"

DESCRIPTION = "
THIS FILE CONTAINS CALIBRATED MAGNETIC FIELD VECTOR DATA OBTAINED BY THE
OUTBOARD MAGNETOMETER ABOARD THE ROSETTA S/C. GROUND CALIBRATION RESULTS HAVE
BEEN APPLIED TO THE RAW DATA. FIELD IS ROTATED TO S/C-COORDS COORDINATES.
THE S/C POSITION IS GIVEN IN S/C-COORDS COORDINATES AS WELL.
DATA ARE AVERAGED TO 1 S MEANS."
FLIGHT_SOFTWARE_VERSION_ID = "FIL:V1.0"
PLATFORM_OR_MOUNTING_DESC = "MAGNETOMETER_BOOM: DEPLOYED"

NOTE = "

- a) MAGNETIC_COORDINATE_SYSTEM : S/C-COORDS
- b) THE VALUES OF THE KEYWORDS SC_SUN_POSITION_VECTOR,
SC_TARGET_POSITION_VECTOR AND SC_TARGET_VELOCITY_VECTOR,
ARE RELATED TO THE ECLIPJ2000 REFERENCE FRAME.
SUB_SPACECRAFT_LATITUDE AND SUB_SPACECRAFT_LONGITUDE
ARE NORTHERN LATITUDE AND EASTERN LONGITUDE IN THE STANDARD
PLANETOCENTRIC IAU <TARGET_NAME> FRAME. ALL VALUES ARE COMPUTED
FOR THE TIME T= START_TIME.
DISTANCES ARE GIVEN IN <KM> VELOCITIES IN <KM/S>, ANGLES IN <DEG>
- c) LBL & TAB FILE HAVE BEEN GENERATED BY S/W: GEN_CAL_DATA, VERSION V20101210
- d) S/C ATTITUDE COMPUTED USING FILE ATNR_FDLRMA_DAP040302093352_00107.ROS
- e) S/C POSITION COMPUTED USING FILE ORHS_FDLRMA_DA_____00107.ROS
- f) GROUND CALIBRATION FILE: RPCMAG_GND_CALIB_FSDPU_FMOB.TXT
- g) INFLIGHT CALIBRATION FILE: RPCMAG_100707_006_CALIB_OB.TXT
- h) DATA SOURCE FOR CLG DATA: LEVEL_C DATA

^TABLE = "RPCMAG100707_CLG_OB_A1.TAB"

OBJECT = TABLE
NAME = "RPCMAG-OB-1S_AVERAGE-CLG"
INTERCHANGE_FORMAT = ASCII
ROWS = 2977
COLUMNS = 9
ROW_BYTES = 125

OBJECT = COLUMN
NAME = "TIME.UTC"
DATA_TYPE = TIME
START_BYTE = 1
BYTES = 26
DESCRIPTION = "UTC TIME OF OBSERVATION: YYYY-MM-DDTHH:MM:SS.FFFFFFFF"

```

END_OBJECT          = COLUMN

OBJECT              = COLUMN
NAME                = "TIME_OBT"
DATA_TYPE           = ASCII_REAL
START_BYTE         = 28
BYTES               = 15
DESCRIPTION         = "S/C CLOCK AT OBSERVATION TIME,SECONDS SINCE 00:00
  AT 1.1.2003: SSSSSSSSS.FFFFF"
END_OBJECT          = COLUMN
OBJECT              = COLUMN
NAME                = "POSITION_X"
DATA_TYPE           = ASCII_REAL
START_BYTE         = 44
BYTES               = 13
UNIT                = "KILOMETER"
UNIT_ID             = "km"
DESCRIPTION         = "SPACECRAFT POSITION, X COMPONENT, S/C-COORDS"
END_OBJECT          = COLUMN

OBJECT              = COLUMN
NAME                = "POSITION_Y"
DATA_TYPE           = ASCII_REAL
START_BYTE         = 58
BYTES               = 13
UNIT                = "KILOMETER"
UNIT_ID             = "km"
DESCRIPTION         = "SPACECRAFT POSITION, Y COMPONENT, S/C-COORDS"
END_OBJECT          = COLUMN

OBJECT              = COLUMN
NAME                = "POSITION_Z"
DATA_TYPE           = ASCII_REAL
START_BYTE         = 72
BYTES               = 13
UNIT                = "KILOMETER"
UNIT_ID             = "km"
DESCRIPTION         = "SPACECRAFT POSITION, Z COMPONENT, S/C-COORDS"
END_OBJECT          = COLUMN

OBJECT              = COLUMN
NAME                = "BX_OB"
DATA_TYPE           = ASCII_REAL
START_BYTE         = 86
BYTES               = 9
UNIT                = "NANOTESLA"
UNIT_ID             = "nT"
DESCRIPTION         = "MAGNETIC FIELD X COMPONENT, CALIBRATED, TEMPERATURE
  CORRECTED DATA, 1S AVERAGE-OB SENSOR, S/C-COORDS"
END_OBJECT          = COLUMN

OBJECT              = COLUMN
NAME                = "BY_OB"
DATA_TYPE           = ASCII_REAL
START_BYTE         = 96
BYTES               = 9
UNIT                = "NANOTESLA"
UNIT_ID             = "nT"
DESCRIPTION         = "MAGNETIC FIELD Y COMPONENT, CALIBRATED, TEMPERATURE

```



```

::::          4 = /residual-field jump detected, reason unknown
::::
::::----- 5 CORRELATION BETWEEN IB AND OB SENSOR
:::          x = correlation not assessed
:::          0 = perfect correlation
:::          1 = good correlation
:::          2 = poor correlation
:::          3 = IB and OB show different long term behavior
::::
::::----- 6 OTHER IMPACTS DECREASING THE QUALITY
:::          x = no assessment
:::          0 = no other problems detected
:::          1 = TBD
:::          2 = TBD
:::          3 = TBD
:::          4 = data disturbed by pulses originated in s/c
:::          5 = data disturbed by AC signal originated in s/c
:::          6 = data noisy due to power on failure
:::          7 = data not calculatable due to thermistor failure
:::          8 = sensor saturated due to huge external field
:::          9 = sensor saturated, instrument power on sequence failed
::::
::::----- 7 TBD
:            x = no assessment
:----- 8 TBD
:            x = no assessment
"
END_OBJECT      = COLUMN
END_OBJECT      = TABLE
END

```

4.3.12 Data Product "RESAMPLED LEVEL_H Magnetic Field data" Design

```

PDS_VERSION_ID      = PDS3
LABEL_REVISION_NOTE = "V1.0"
RECORD_TYPE         = FIXED_LENGTH
RECORD_BYTES        = 125
FILE_RECORDS        = 429568
DATA_SET_ID         = "RO-A-RPCMAG-4-AST2-RESAMPLED-V3.0"
DATA_SET_NAME       = "ROSETTA-ORBITER LUTETIA RPCMAG 4 AST2 RESAMPLED V3.0"
PRODUCT_ID          = "RPCMAG100710T1255_CLH_OB_M3"
PRODUCT_CREATION_TIME = 2012-06-19T12:50:00
PRODUCT_TYPE        = "REFDR"
MISSION_ID          = "ROSETTA"
MISSION_NAME        = "INTERNATIONAL ROSETTA MISSION"
MISSION_PHASE_NAME  = "LUTETIA FLY-BY"
OBSERVATION_TYPE    = "LUTETIA FLYBY"
INSTRUMENT_HOST_ID  = "RO"
INSTRUMENT_HOST_NAME = "ROSETTA-ORBITER"
INSTRUMENT_ID       = "RPCMAG"
INSTRUMENT_NAME     = "ROSETTA PLASMA CONSORTIUM - FLUXGATE MAGNETOMETER"
INSTRUMENT_TYPE     = "MAGNETOMETER"

```

```

INSTRUMENT_MODE_ID           = "SID3"
INSTRUMENT_MODE_DESC         = ""
BURST MODE: 320 PRIMARY & 16 SECONDARY VECTORS PER 16 SECONDS"
TARGET_NAME                   = "21 LUTETIA"
TARGET_TYPE                   = "ASTEROID"
COORDINATE_SYSTEM_CENTER_NAME = "LUTETIA"
START_TIME                    = 2010-07-10T12:55:03.318
STOP_TIME                     = 2010-07-10T18:53:01.668
SPACECRAFT_CLOCK_START_COUNT  = "1/237387262.23603"
SPACECRAFT_CLOCK_STOP_COUNT  = "1/237408740.46451"

START_JULIAN_DATE_VALUE      = 2455388.0382328476
STOP_JULIAN_DATE_VALUE      = 2455388.2868248615
SC_SUN_POSITION_VECTOR      = ( 400949428.69, 65138090.88, -20644506.41)
SC_TARGET_POSITION_VECTOR   = ( -152824.56, 1394.27, 2975.72)
SC_TARGET_VELOCITY_VECTOR   = ( 14.99, -0.44, -0.23)
SPACECRAFT_ALTITUDE         = 152808.094
SUB_SPACECRAFT_LATITUDE     = "N/A"
SUB_SPACECRAFT_LONGITUDE    = "N/A"
SPICE_FILE_NAME             = {"ATNR_P040302093352_00125.BC",
                              "ROS_LBOOM_V0.BC",
                              "ROS_V18.TF",
                              "ROS_SA_2004_V0001.BC",
                              "ROS_SA_2005_V0001.BC",
                              "ROS_SA_2006_V0001.BC",
                              "ROS_SA_2007_V0001.BC",
                              "ROS_SA_2008_V0038.BC",
                              "ROS_SA_2009_V0054.BC",
                              "ROS_SA_2010_V0052.BC",
                              "ROS_SA_2011_V0013.BC",
                              "ROS_HGA_2008_V0018.BC",
                              "ROS_HGA_2009_V0051.BC",
                              "ROS_HGA_2010_V0045.BC",
                              "ROS_HGA_2011_V0009.BC",
                              "ROS_RPC_V15.TI",
                              "NAIF0010.TLS",
                              "PCK00010.TPC",
                              "DE403-MASSES.TPC",
                              "ROS_110405_STEP.TSC",
                              "ORER_____00031.BSP",
                              "ORFR_____00067.BSP",
                              "ORGR_____00096.BSP",
                              "ORHR_____00122.BSP",
                              "ORMR_____00052.BSP",
                              "ORHO_____00077.BSP",
                              "ROS_RPC_STRUCT_V1.BSP",
                              "ROS_STRUCT_V2.BSP",
                              "EARTH_TOPO_050714.TF",
                              "EARTHFIXEDIAU.TF",
                              "EARTHFIXEDITRF93.TF",
                              "RSSD0002.TF",
                              "LUTETIA_CSEQ.TF",
                              "ROS_LUTETIA_RSOC_V01.TF",
                              "EARTH_000101_060918_060627.BPC",
                              "ROS_LUTETIA_LC1_V02.TPC",
                              "ROS_LUTETIA_LC2_V02.TPC",
                              "ROS_LUTETIA_R1_V02.TPC",
                              "ROS_LUTETIA_R2_V02.TPC",
                              "ROS_LUTETIA_RSOC_V03.TPC",
                              "DE405.BSP",

```

"DSNSTNS.BSP",
"ORHS _____ 00109.BSP"}

PRODUCER_ID = "RPC_MAG_TEAM"
PRODUCER_FULL_NAME = "INGO RICHTER"
PRODUCER_INSTITUTION_NAME = "IGEP-TU-BRAUNSCHWEIG"
DATA_QUALITY_ID = "N/A"
DATA_QUALITY_DESC = "
ONLY 'GOOD' RAW DATA HAVE BEEN PROCESSED AND STORED"
PROCESSING_LEVEL_ID = "4"

DESCRIPTION = "
THIS FILE CONTAINS CALIBRATED MAGNETIC FIELD VECTOR DATA OBTAINED BY THE
OUTBOARD MAGNETOMETER ABOARD THE ROSETTA S/C. GROUND CALIBRATION RESULTS HAVE
BEEN APPLIED TO THE RAW DATA. FIELD IS ROTATED TO S/C-COORDS COORDINATES.
THE S/C POSITION IS GIVEN IN S/C-COORDS COORDINATES AS WELL.
LAP DISTURBANCE OCCURRING AT CONSTANT FREQUENCIES HAS BEEN ELIMINATED.
DYNAMIC REACTION WHEEL DISTURBANCE SIGNATURE ELIMINATED IN SPECTRUM."
FLIGHT_SOFTWARE_VERSION_ID = "FIL:V1.0"
PLATFORM_OR_MOUNTING_DESC = "MAGNETOMETER_BOOM:DEPLOYED"

NOTE = "
a)
MAGNETIC_COORDINATE_SYSTEM : S/C-COORDS
b)
THE VALUES OF THE KEYWORDS SC_SUN_POSITION_VECTOR,
SC_TARGET_POSITION_VECTOR AND SC_TARGET_VELOCITY_VECTOR,
ARE RELATED TO THE ECLIPJ2000 REFERENCE FRAME.
SUB_SPACECRAFT_LATITUDE AND SUB_SPACECRAFT_LONGITUDE
ARE NORTHERN LATITUDE AND EASTERN LONGITUDE IN THE STANDARD
PLANETOCENTRIC IAU <TARGET_NAME> FRAME. ALL VALUES ARE COMPUTED
FOR THE TIME T= START TIME.
DISTANCES ARE GIVEN IN <KM> VELOCITIES IN <KM/S>, ANGLES IN <DEG>
c)
LBL & TAB FILE HAVE BEEN GENERATED BY S/W: GEN_CAL_DATA, VERSION V20101210
d)
S/C ATTITUDE COMPUTED USING FILE ATNR_FDLRMA_DAP040302093352_00107.ROS
e)
S/C POSITION COMPUTED USING FILE ORHS_FDLRMA_DA_____00107.ROS
f)
GROUND CALIBRATION FILE: RPCMAG_GND_CALIB_FSDPU_FMOB.TXT
g)
INFLIGHT CALIBRATION FILE: RPCMAG_100710_006_CALIB_OB.TXT
h)
REACTION WHEEL CORRECTIONS HAVE BEEN COMPUTED USING FILE:
D:\ROSETTA\DATA\REACTION_WHEELS\ASCII_DATA\SCHK7_2010-07-10.TXT
THIS REFERENCE IS LISTED FOR INTERNAL USE ONLY.THE FILE IS NOT DELIVERED TO
THE ARCHIVE. REACTION WHEEL DATA CAN BE FOUND ON THE ROSETTA DDS
i)
DATA SOURCE FOR CLH DATA: LEVEL_C DATA

^TABLE = "RPCMAG100710T1255_CLH_OB_M3.TAB"

OBJECT = TABLE
NAME = "RPCMAG-OB-RW_CORR-CLH"
INTERCHANGE_FORMAT = ASCII
ROWS = 429568
COLUMNS = 9
ROW_BYTES = 125

OBJECT = COLUMN
NAME = "TIME UTC"
DATA_TYPE = TIME
START_BYTE = 1
BYTES = 26
DESCRIPTION = "UTC TIME OF OBSERVATION: YYYY-MM-DDTHH:MM:SS.FFFFFFFF"
END_OBJECT = COLUMN

OBJECT = COLUMN
NAME = "TIME_OBT"
DATA_TYPE = ASCII_REAL
START_BYTE = 28
BYTES = 15
DESCRIPTION = "S/C CLOCK AT OBSERVATION TIME, SECONDS SINCE 00:00
AT 1.1.2003: SSSSSSSS.FFFFFF"
END_OBJECT = COLUMN
OBJECT = COLUMN
NAME = "POSITION_X"
DATA_TYPE = ASCII_REAL
START_BYTE = 44
BYTES = 13
UNIT = "KILOMETER"
UNIT_ID = "km"
DESCRIPTION = "SPACECRAFT POSITION, X COMPONENT, S/C-COORDS"
END_OBJECT = COLUMN

OBJECT = COLUMN
NAME = "POSITION_Y"
DATA_TYPE = ASCII_REAL
START_BYTE = 58
BYTES = 13
UNIT = "KILOMETER"
UNIT_ID = "km"
DESCRIPTION = "SPACECRAFT POSITION, Y COMPONENT, S/C-COORDS"
END_OBJECT = COLUMN

OBJECT = COLUMN
NAME = "POSITION_Z"
DATA_TYPE = ASCII_REAL
START_BYTE = 72
BYTES = 13
UNIT = "KILOMETER"
UNIT_ID = "km"
DESCRIPTION = "SPACECRAFT POSITION, Z COMPONENT, S/C-COORDS"
END_OBJECT = COLUMN

OBJECT = COLUMN
NAME = "BX_OB"
DATA_TYPE = ASCII_REAL
START_BYTE = 86
BYTES = 9
UNIT = "NANOTESLA"
UNIT_ID = "nT"
DESCRIPTION = "MAGNETIC FIELD X COMPONENT, CALIBRATED, TEMPERATURE
AND REACTION WHEEL AND LAP DISTURBANCE CORRECTED DATA,
OB SENSOR, S/C-COORDS"
END_OBJECT = COLUMN

OBJECT = COLUMN

```

::: 3 = pyros fired for boom release
:::
:::----- 4 OFFSET/RESIDUAL-FIELD RELATED EFFECTS:
::: x = offset/residual-field issues not assessed
::: 0 = no offset/residual-field problems
::: 1 = offset/residual-field behavior not clear
::: 2 = offset drifts, sensor not in thermal
::: equilibrium thus temperature model N/A
::: 3 = offset/residual-field drifts, reason unknown
::: 4 = /residual-field jump detected, reason unknown
:::
:::----- 5 CORRELATION BETWEEN IB AND OB SENSOR
::: x = correlation not assessed
::: 0 = perfect correlation
::: 1 = good correlation
::: 2 = poor correlation
::: 3 = IB and OB show different long term behavior
:::
:::----- 6 OTHER IMPACTS DECREASING THE QUALITY
::: x = no assessment
::: 0 = no other problems detected
::: 1 = TBD
::: 2 = TBD
::: 3 = TBD
::: 4 = data disturbed by pulses originated in s/c
::: 5 = data disturbed by AC signal originated in s/c
::: 6 = data noisy due to power on failure
::: 7 = data not calculatable due to thermistor failure
::: 8 = sensor saturated due to huge external field
::: 9 = sensor saturated, instrument power on sequence failed
:::
:::----- 7 TBD
::: x = no assessment
:::----- 8 TBD
::: x = no assessment
"
END_OBJECT = COLUMN
END_OBJECT = TABLE
END

```

4.3.13 Data Product "RESAMPLED LEVEL_I Magnetic Field data" Design

This data product is usually not generated. Format like LEVEL_L.

4.3.14 Data Product "DERIVED LEVEL_J Magnetic Field data" Design

```

PDS_VERSION_ID           = PDS3
LABEL_REVISION_NOTE      = "V1.0"
RECORD_TYPE              = FIXED_LENGTH
RECORD_BYTES            = 125
FILE_RECORDS             = 85459
DATA_SET_ID              = "RO-E-RPCMAG-5-EAR1-DERIVED-V3.0"
DATA_SET_NAME = "ROSETTA-ORBITER EARTH RPCMAG 5 EAR1 DERIVED V3.0"
PRODUCT_ID               = "RPCMAG050301_CLJ_A1_C"
PRODUCT_CREATION_TIME    = 2012-06-20T11:00:00
PRODUCT_TYPE             = "DDR"
MISSION_ID               = "ROSETTA"
MISSION_NAME              = "INTERNATIONAL ROSETTA MISSION"
MISSION_PHASE_NAME       = "EARTH SWING-BY 1"
OBSERVATION_TYPE         = "EARTH SWINGBY 1"
ORBIT_NUMBER             = "N/A"
INSTRUMENT_HOST_ID       = "RO"
INSTRUMENT_HOST_NAME     = "ROSETTA-ORBITER"
INSTRUMENT_ID            = "RPCMAG"
INSTRUMENT_NAME = "ROSETTA PLASMA CONSORTIUM - FLUXGATE MAGNETOMETER"
INSTRUMENT_TYPE          = "MAGNETOMETER"
INSTRUMENT_MODE_ID       = "AVERAGED"
INSTRUMENT_MODE_DESC     = "1 S AVERAGES"
COORDINATE_SYSTEM_CENTER_NAME = "SUN"
TARGET_NAME              = "EARTH"
TARGET_TYPE              = "PLANET"
START_TIME               = 2005-03-01T00:14:42.154
STOP_TIME                = 2005-03-01T23:59:00.154
SPACECRAFT_CLOCK_START_COUNT = "1/68256862.70971"
SPACECRAFT_CLOCK_STOP_COUNT = "1/68342320.70971"

START_JULIAN_DATE_VALUE  = 2453430.5102101164
STOP_JULIAN_DATE_VALUE   = 2453431.4993073386
SC_SUN_POSITION_VECTOR   = ( 141029090.37, -49951656.75, 73685.77)
SC_TARGET_POSITION_VECTOR = ( 1358529.07, -322204.71, 73167.53)
SC_TARGET_VELOCITY_VECTOR = ( -3.85, 0.86, -0.22)
SPACECRAFT_ALTITUDE      = 1391753.012
SUB_SPACECRAFT_LATITUDE  = "N/A"
SUB_SPACECRAFT_LONGITUDE = "N/A"
SPICE_FILE_NAME          = {"ATNR_P040302093352_00125.BC",
                           "ROS_LBOOM_V0.BC",
                           "ROS_V18.TF",
                           "ROS_SA_2004_V0001.BC",
                           "ROS_SA_2005_V0001.BC",
                           "ROS_SA_2006_V0001.BC",
                           "ROS_SA_2007_V0001.BC",
                           "ROS_SA_2008_V0038.BC",
                           "ROS_SA_2009_V0054.BC",
                           "ROS_SA_2010_V0052.BC",
                           "ROS_SA_2011_V0013.BC",
                           "ROS_HGA_2008_V0018.BC",
                           "ROS_HGA_2009_V0051.BC",
                           "ROS_HGA_2010_V0045.BC",
                           "ROS_HGA_2011_V0009.BC",

```

```
"ROS_RPC_V15.TI",
"NAIF0010.TLS",
"PCK00010.TPC",
"DE403-MASSES.TPC",
"ROS_110405_STEP.TSC",
"ORER_____00031.BSP",
"ORFR_____00067.BSP",
"ORGR_____00096.BSP",
"ORHR_____00122.BSP",
"ORMR_____00052.BSP",
"ORHO_____00077.BSP",
"ROS_RPC_STRUCT_V1.BSP",
"ROS_STRUCT_V2.BSP",
"EARTH_TOPO_050714.TF",
"EARTHFIXEDIAU.TF",
"EARTHFIXEDITRF93.TF",
"EARTH_000101_060918_060627.BPC",
"DE405.BSP"}
```

```
PRODUCER_ID = "RPC_MAG_TEAM"
PRODUCER_FULL_NAME = "INGO RICHTER"
PRODUCER_INSTITUTION_NAME = "IGEP-TU-BRAUNSCHWEIG"
PROCESSING_LEVEL_ID = "5"
DATA_QUALITY_ID = "N/A"
DATA_QUALITY_DESC = "
  ONLY 'GOOD' RAW DATA HAVE BEEN PROCESSED AND STORED"
```

```
DESCRIPTION = "
  THIS FILE CONTAINS CALIBRATED MAGNETIC FIELD VECTOR DATA OBTAINED BY THE
  MAGNETOMETER ABOARD THE ROSETTA S/C. GROUND CALIBRATION RESULTS HAVE BEEN
  APPLIED TO THE RAW DATA. FIELD IS ROTATED TO S/C-COORDS COORDINATES. THE
  S/C POSITION IS GIVEN IN S/C-COORDS COORDINATES AS WELL. DATA ARE AVERAGED
  TO 1 S MEANS. A PCA HAS BEEN APPLIED. THIS DATA SET CONTAINS THE
  CORRELATED DATA"
FLIGHT_SOFTWARE_VERSION_ID = "FIL:V1.0"
PLATFORM_OR_MOUNTING_DESC = "MAGNETOMETER_BOOM: DEPLOYED"
```

```
NOTE = "
a)
  MAGNETIC_COORDINATE_SYSTEM : S/C-COORDS
b)
  THE VALUES OF THE KEYWORDS SC_SUN_POSITION_VECTOR,
  SC_TARGET_POSITION_VECTOR AND SC_TARGET_VELOCITY_VECTOR,
  ARE RELATED TO THE ECLIPJ2000 REFERENCE FRAME.
  SUB_SPACECRAFT_LATITUDE AND SUB_SPACECRAFT_LONGITUDE
  ARE NORTHERN LATITUDE AND EASTERN LONGITUDE IN THE STANDARD
  PLANETOCENTRIC IAU <TARGET_NAME> FRAME. ALL VALUES ARE COMPUTED
  FOR THE TIME T= START_TIME.
  DISTANCES ARE GIVEN IN <KM> VELOCITIES IN <KM/S>, ANGLES IN <DEG>
c)
  LBL & TAB FILE HAVE BEEN GENERATED BY S/W: GEN_CAL_DATA, VERSION V20101210
d)
  S/C ATTITUDE COMPUTED USING FILE ATNR_FDLRMA_DAP040302093352_00107.ROS
e)
  S/C POSITION COMPUTED USING FILE ORHR_FDLRMA_DA_____00107.ROS
f)
  GROUND CALIBRATION FILE: RPCMAG_GND_CALIB_FSDPU_F.TXT
g)
  INFLIGHT CALIBRATION FILE: RPCMAG_002_CALIB_.TXT
h)
```

NOTE =

i)

DATA SOURCE FOR LEVEL_G DATA WERE LEVEL_L DATA

```

^TABLE = "RPCMAG050301_CLJ_A1_C.TAB"

OBJECT = TABLE
NAME = "RPCMAG-CORR_PCA_DATA-1S_AVERAGE-CLJ"
INTERCHANGE_FORMAT = ASCII
ROWS = 85459
COLUMNS = 9
ROW_BYTES = 125

OBJECT = COLUMN
NAME = "TIME.UTC"
DATA_TYPE = TIME
START_BYTE = 1
BYTES = 26
DESCRIPTION = "UTC TIME OF OBSERVATION: YYYY-MM-DDTHH:MM:SS.FFFFFFFF"
END_OBJECT = COLUMN

OBJECT = COLUMN
NAME = "TIME.OBT"
DATA_TYPE = ASCII_REAL
START_BYTE = 28
BYTES = 15
DESCRIPTION = "S/C CLOCK AT OBSERVATION TIME,SECONDS SINCE 00:00
AT 1.1.2003: SSSSSSSSS.FFFFFF"
END_OBJECT = COLUMN
OBJECT = COLUMN
NAME = "POSITION.X"
DATA_TYPE = ASCII_REAL
START_BYTE = 44
BYTES = 13
UNIT = "KILOMETER"
UNIT_ID = "km"
DESCRIPTION = "SPACECRAFT POSITION, X COMPONENT, S/C-COORDS"
END_OBJECT = COLUMN

OBJECT = COLUMN
NAME = "POSITION.Y"
DATA_TYPE = ASCII_REAL
START_BYTE = 58
BYTES = 13
UNIT = "KILOMETER"
UNIT_ID = "km"
DESCRIPTION = "SPACECRAFT POSITION, Y COMPONENT, S/C-COORDS"
END_OBJECT = COLUMN

OBJECT = COLUMN
NAME = "POSITION.Z"
DATA_TYPE = ASCII_REAL
START_BYTE = 72
BYTES = 13
UNIT = "KILOMETER"
UNIT_ID = "km"
DESCRIPTION = "SPACECRAFT POSITION, Z COMPONENT, S/C-COORDS"
END_OBJECT = COLUMN

```



```

: : : : :      0 = no disturbance
: : : : :      1 = disturbance eliminated during data analysis
: : : : :      2 = disturbance elimination failed
: : : : :      3 = data disturbed
: : : : :
: : : : :----- 3 BOOM DEPLOYMENT:
: : : : :      0 = boom deployed
: : : : :      1 = boom stowed
: : : : :      2 = boom deployment ongoing. Data only valid in
: : : : :          instrument coordinates
: : : : :      3 = pyros fired for boom release
: : : : :
: : : : :----- 4 OFFSET/RESIDUAL-FIELD RELATED EFFECTS:
: : : : :      x = offset/residual-field issues not assessed
: : : : :      0 = no offset/residual-field problems
: : : : :      1 = offset/residual-field behavior not clear
: : : : :      2 = offset drifts, sensor not in thermal
: : : : :          equilibrium thus temperature model N/A
: : : : :      3 = offset/residual-field drifts, reason unknown
: : : : :      4 = /residual-field jump detected, reason unknown
: : : : :
: : : : :----- 5 CORRELATION BETWEEN IB AND OB SENSOR
: : : : :      x = correlation not assessed
: : : : :      0 = perfect correlation
: : : : :      1 = good correlation
: : : : :      2 = poor correlation
: : : : :      3 = IB and OB show different long term behavior
: : : : :
: : : : :----- 6 OTHER IMPACTS DECREASING THE QUALITY
: : : : :      x = no assessment
: : : : :      0 = no other problems detected
: : : : :      1 = TBD
: : : : :      2 = TBD
: : : : :      3 = TBD
: : : : :      4 = data disturbed by pulses originated in s/c
: : : : :      5 = data disturbed by AC signal originated in s/c
: : : : :      6 = data noisy due to power on failure
: : : : :      7 = data not calculatable due to thermistor failure
: : : : :      8 = sensor saturated due to huge external field
: : : : :      9 = sensor saturated, instrument power on sequence failed
: : : : :
: : : : :----- 7 TBD
: : : : :      x = no assessment
: : : : :----- 8 TBD
: : : : :      x = no assessment
: : : : :
"
END_OBJECT      = COLUMN
END_OBJECT      = TABLE
END

```

5 Appendix: Available Software to read PDS files

There is no special S/W available to read our PDS files.

6 Appendix: Example of Directory Listing of Data Set X

```
DATA_SET_ID
├── DOCUMENT
│   ├── CALIBRATION
│   ├── FLIGHT_REPORTS
│   └── ARCHIVING
├── CALIB
├── CATALOG
├── INDEX
└── DATA
    ├── CALIBRATED
    │   └── 2005
    │       └── MAR
    │           ├── LEVEL_A
    │           │   ├── OB
    │           │   ├── IB
    │           │   └── HK
    │           ├── LEVEL_B
    │           │   ├── OB
    │           │   └── IB
    │           └── LEVEL_C
    │               ├── OB
    │               └── IB
```

RO-A-RPCMAG-3-AST2-CALIBRATED-V3.0\PDSVOLUME.XML
RO-A-RPCMAG-3-AST2-CALIBRATED-V3.0\AAREADME.TXT
RO-A-RPCMAG-3-AST2-CALIBRATED-V3.0\CALIB
RO-A-RPCMAG-3-AST2-CALIBRATED-V3.0\CATALOG
RO-A-RPCMAG-3-AST2-CALIBRATED-V3.0\DATA
RO-A-RPCMAG-3-AST2-CALIBRATED-V3.0\DOCUMENT
RO-A-RPCMAG-3-AST2-CALIBRATED-V3.0\ERRATA.TXT
RO-A-RPCMAG-3-AST2-CALIBRATED-V3.0\INDEX
RO-A-RPCMAG-3-AST2-CALIBRATED-V3.0\VOLDESC.CAT
RO-A-RPCMAG-3-AST2-CALIBRATED-V3.0\CALIB\CALINFO.TXT
RO-A-RPCMAG-3-AST2-CALIBRATED-V3.0\CALIB\RPCMAG_100707_006_CALIB_IB.LBL
RO-A-RPCMAG-3-AST2-CALIBRATED-V3.0\CALIB\RPCMAG_100707_006_CALIB_IB.TXT
RO-A-RPCMAG-3-AST2-CALIBRATED-V3.0\CALIB\RPCMAG_100707_006_CALIB_OB.LBL
RO-A-RPCMAG-3-AST2-CALIBRATED-V3.0\CALIB\RPCMAG_100707_006_CALIB_OB.TXT
RO-A-RPCMAG-3-AST2-CALIBRATED-V3.0\CALIB\RPCMAG_100708_006_CALIB_IB.LBL
RO-A-RPCMAG-3-AST2-CALIBRATED-V3.0\CALIB\RPCMAG_100708_006_CALIB_IB.TXT
RO-A-RPCMAG-3-AST2-CALIBRATED-V3.0\CALIB\RPCMAG_100708_006_CALIB_OB.LBL
RO-A-RPCMAG-3-AST2-CALIBRATED-V3.0\CALIB\RPCMAG_100708_006_CALIB_OB.TXT
RO-A-RPCMAG-3-AST2-CALIBRATED-V3.0\CALIB\RPCMAG_100709_006_CALIB_IB.LBL
RO-A-RPCMAG-3-AST2-CALIBRATED-V3.0\CALIB\RPCMAG_100709_006_CALIB_IB.TXT
RO-A-RPCMAG-3-AST2-CALIBRATED-V3.0\CALIB\RPCMAG_100709_006_CALIB_OB.LBL
RO-A-RPCMAG-3-AST2-CALIBRATED-V3.0\CALIB\RPCMAG_100709_006_CALIB_OB.TXT
RO-A-RPCMAG-3-AST2-CALIBRATED-V3.0\CALIB\RPCMAG_100710_006_CALIB_IB.LBL
RO-A-RPCMAG-3-AST2-CALIBRATED-V3.0\CALIB\RPCMAG_100710_006_CALIB_IB.TXT
RO-A-RPCMAG-3-AST2-CALIBRATED-V3.0\CALIB\RPCMAG_100710_006_CALIB_OB.LBL
RO-A-RPCMAG-3-AST2-CALIBRATED-V3.0\CALIB\RPCMAG_100710_006_CALIB_OB.TXT
RO-A-RPCMAG-3-AST2-CALIBRATED-V3.0\CALIB\RPCMAG_100711_006_CALIB_IB.LBL
RO-A-RPCMAG-3-AST2-CALIBRATED-V3.0\CALIB\RPCMAG_100711_006_CALIB_IB.TXT
RO-A-RPCMAG-3-AST2-CALIBRATED-V3.0\CALIB\RPCMAG_100711_006_CALIB_OB.LBL
RO-A-RPCMAG-3-AST2-CALIBRATED-V3.0\CALIB\RPCMAG_100711_006_CALIB_OB.TXT
RO-A-RPCMAG-3-AST2-CALIBRATED-V3.0\CALIB\RPCMAG_100712_006_CALIB_IB.LBL
RO-A-RPCMAG-3-AST2-CALIBRATED-V3.0\CALIB\RPCMAG_100712_006_CALIB_IB.TXT
RO-A-RPCMAG-3-AST2-CALIBRATED-V3.0\CALIB\RPCMAG_100712_006_CALIB_OB.LBL
RO-A-RPCMAG-3-AST2-CALIBRATED-V3.0\CALIB\RPCMAG_100712_006_CALIB_OB.TXT
RO-A-RPCMAG-3-AST2-CALIBRATED-V3.0\CALIB\RPCMAG_100713_006_CALIB_IB.LBL
RO-A-RPCMAG-3-AST2-CALIBRATED-V3.0\CALIB\RPCMAG_100713_006_CALIB_IB.TXT
RO-A-RPCMAG-3-AST2-CALIBRATED-V3.0\CALIB\RPCMAG_100713_006_CALIB_OB.LBL
RO-A-RPCMAG-3-AST2-CALIBRATED-V3.0\CALIB\RPCMAG_100713_006_CALIB_OB.TXT
RO-A-RPCMAG-3-AST2-CALIBRATED-V3.0\CALIB\RPCMAG_BOOM_ALIGN_CORR_EF1.LBL
RO-A-RPCMAG-3-AST2-CALIBRATED-V3.0\CALIB\RPCMAG_BOOM_ALIGN_CORR_EF1.TXT
RO-A-RPCMAG-3-AST2-CALIBRATED-V3.0\CALIB\RPCMAG_GND_CALIB_FSDPU_FMIB.LBL
RO-A-RPCMAG-3-AST2-CALIBRATED-V3.0\CALIB\RPCMAG_GND_CALIB_FSDPU_FMIB.TXT
RO-A-RPCMAG-3-AST2-CALIBRATED-V3.0\CALIB\RPCMAG_GND_CALIB_FSDPU_FMOB.LBL
RO-A-RPCMAG-3-AST2-CALIBRATED-V3.0\CALIB\RPCMAG_GND_CALIB_FSDPU_FMOB.TXT
RO-A-RPCMAG-3-AST2-CALIBRATED-V3.0\CALIB\RPCMAG_SC_ALIGN.LBL
RO-A-RPCMAG-3-AST2-CALIBRATED-V3.0\CALIB\RPCMAG_SC_ALIGN.TXT
RO-A-RPCMAG-3-AST2-CALIBRATED-V3.0\CATALOG\CATINFO.TXT
RO-A-RPCMAG-3-AST2-CALIBRATED-V3.0\CATALOG\DATASET.CAT
RO-A-RPCMAG-3-AST2-CALIBRATED-V3.0\CATALOG\ROSETTA_INSTHOST.CAT
RO-A-RPCMAG-3-AST2-CALIBRATED-V3.0\CATALOG\ROSETTA_MISSION.CAT
RO-A-RPCMAG-3-AST2-CALIBRATED-V3.0\CATALOG\ROSETTA_REF.CAT
RO-A-RPCMAG-3-AST2-CALIBRATED-V3.0\CATALOG\ROSETTA_TARGET.CAT
RO-A-RPCMAG-3-AST2-CALIBRATED-V3.0\CATALOG\RPCMAG_INST.CAT
RO-A-RPCMAG-3-AST2-CALIBRATED-V3.0\CATALOG\RPCMAG_PERS.CAT
RO-A-RPCMAG-3-AST2-CALIBRATED-V3.0\CATALOG\RPCMAG_SOFTWARE.CAT
RO-A-RPCMAG-3-AST2-CALIBRATED-V3.0\DATA\CALIBRATED
RO-A-RPCMAG-3-AST2-CALIBRATED-V3.0\DATA\CALIBRATED\2010
RO-A-RPCMAG-3-AST2-CALIBRATED-V3.0\DATA\CALIBRATED\2010\JUL
RO-A-RPCMAG-3-AST2-CALIBRATED-V3.0\DATA\CALIBRATED\2010\JUL\LEVEL_A
RO-A-RPCMAG-3-AST2-CALIBRATED-V3.0\DATA\CALIBRATED\2010\JUL\LEVEL_B
RO-A-RPCMAG-3-AST2-CALIBRATED-V3.0\DATA\CALIBRATED\2010\JUL\LEVEL_C
RO-A-RPCMAG-3-AST2-CALIBRATED-V3.0\DATA\CALIBRATED\2010\JUL\LEVEL_A\HK
RO-A-RPCMAG-3-AST2-CALIBRATED-V3.0\DATA\CALIBRATED\2010\JUL\LEVEL_A\IB
RO-A-RPCMAG-3-AST2-CALIBRATED-V3.0\DATA\CALIBRATED\2010\JUL\LEVEL_A\OB
RO-A-RPCMAG-3-AST2-CALIBRATED-V3.0\DATA\CALIBRATED\2010\JUL\LEVEL_A\HK\RPCMAG100707T1542_CLA_HK.LBL
RO-A-RPCMAG-3-AST2-CALIBRATED-V3.0\DATA\CALIBRATED\2010\JUL\LEVEL_A\HK\RPCMAG100707T1542_CLA_HK.TAB
RO-A-RPCMAG-3-AST2-CALIBRATED-V3.0\DATA\CALIBRATED\2010\JUL\LEVEL_A\HK\RPCMAG100708T0000_CLA_HK.LBL
RO-A-RPCMAG-3-AST2-CALIBRATED-V3.0\DATA\CALIBRATED\2010\JUL\LEVEL_A\HK\RPCMAG100708T0000_CLA_HK.TAB
RO-A-RPCMAG-3-AST2-CALIBRATED-V3.0\DATA\CALIBRATED\2010\JUL\LEVEL_A\HK\RPCMAG100709T0000_CLA_HK.LBL
RO-A-RPCMAG-3-AST2-CALIBRATED-V3.0\DATA\CALIBRATED\2010\JUL\LEVEL_A\HK\RPCMAG100709T0000_CLA_HK.TAB
RO-A-RPCMAG-3-AST2-CALIBRATED-V3.0\DATA\CALIBRATED\2010\JUL\LEVEL_A\HK\RPCMAG100710T0000_CLA_HK.LBL
RO-A-RPCMAG-3-AST2-CALIBRATED-V3.0\DATA\CALIBRATED\2010\JUL\LEVEL_A\HK\RPCMAG100710T0000_CLA_HK.TAB
RO-A-RPCMAG-3-AST2-CALIBRATED-V3.0\DATA\CALIBRATED\2010\JUL\LEVEL_A\HK\RPCMAG100711T0000_CLA_HK.LBL
RO-A-RPCMAG-3-AST2-CALIBRATED-V3.0\DATA\CALIBRATED\2010\JUL\LEVEL_A\HK\RPCMAG100711T0000_CLA_HK.TAB
RO-A-RPCMAG-3-AST2-CALIBRATED-V3.0\DATA\CALIBRATED\2010\JUL\LEVEL_A\HK\RPCMAG100712T0000_CLA_HK.LBL
RO-A-RPCMAG-3-AST2-CALIBRATED-V3.0\DATA\CALIBRATED\2010\JUL\LEVEL_A\HK\RPCMAG100712T0000_CLA_HK.TAB
RO-A-RPCMAG-3-AST2-CALIBRATED-V3.0\DATA\CALIBRATED\2010\JUL\LEVEL_A\HK\RPCMAG100713T0000_CLA_HK.LBL
RO-A-RPCMAG-3-AST2-CALIBRATED-V3.0\DATA\CALIBRATED\2010\JUL\LEVEL_A\HK\RPCMAG100713T0000_CLA_HK.TAB
RO-A-RPCMAG-3-AST2-CALIBRATED-V3.0\DATA\CALIBRATED\2010\JUL\LEVEL_A\IB\RPCMAG100707T1610_CLA_IB_M2.LBL
RO-A-RPCMAG-3-AST2-CALIBRATED-V3.0\DATA\CALIBRATED\2010\JUL\LEVEL_A\IB\RPCMAG100707T1610_CLA_IB_M2.TAB
RO-A-RPCMAG-3-AST2-CALIBRATED-V3.0\DATA\CALIBRATED\2010\JUL\LEVEL_A\IB\RPCMAG100708T0000_CLA_IB_M2.LBL
RO-A-RPCMAG-3-AST2-CALIBRATED-V3.0\DATA\CALIBRATED\2010\JUL\LEVEL_A\IB\RPCMAG100708T0000_CLA_IB_M2.TAB
RO-A-RPCMAG-3-AST2-CALIBRATED-V3.0\DATA\CALIBRATED\2010\JUL\LEVEL_A\IB\RPCMAG100709T0000_CLA_IB_M2.LBL
RO-A-RPCMAG-3-AST2-CALIBRATED-V3.0\DATA\CALIBRATED\2010\JUL\LEVEL_A\IB\RPCMAG100709T0000_CLA_IB_M2.TAB
RO-A-RPCMAG-3-AST2-CALIBRATED-V3.0\DATA\CALIBRATED\2010\JUL\LEVEL_A\IB\RPCMAG100710T0000_CLA_IB_M2.LBL
RO-A-RPCMAG-3-AST2-CALIBRATED-V3.0\DATA\CALIBRATED\2010\JUL\LEVEL_A\IB\RPCMAG100710T0000_CLA_IB_M2.TAB
RO-A-RPCMAG-3-AST2-CALIBRATED-V3.0\DATA\CALIBRATED\2010\JUL\LEVEL_A\IB\RPCMAG100710T1255_CLA_IB_M3.LBL

RO-A-RPCMAG-3-AST2-CALIBRATED-V3.0\DATA\CALIBRATED\2010\JUL\LEVEL_C\OB\RPCMAG100712T0000_CLC_OB_M2.LBL
RO-A-RPCMAG-3-AST2-CALIBRATED-V3.0\DATA\CALIBRATED\2010\JUL\LEVEL_C\OB\RPCMAG100712T0000_CLC_OB_M2.TAB
RO-A-RPCMAG-3-AST2-CALIBRATED-V3.0\DATA\CALIBRATED\2010\JUL\LEVEL_C\OB\RPCMAG100713T0000_CLC_OB_M2.LBL
RO-A-RPCMAG-3-AST2-CALIBRATED-V3.0\DATA\CALIBRATED\2010\JUL\LEVEL_C\OB\RPCMAG100713T0000_CLC_OB_M2.TAB
RO-A-RPCMAG-3-AST2-CALIBRATED-V3.0\DOCUMENT\ARCHIVING
RO-A-RPCMAG-3-AST2-CALIBRATED-V3.0\DOCUMENT\CALIBRATION
RO-A-RPCMAG-3-AST2-CALIBRATED-V3.0\DOCUMENT\DOCINFO.TXT
RO-A-RPCMAG-3-AST2-CALIBRATED-V3.0\DOCUMENT\FLIGHT_REPORTS
RO-A-RPCMAG-3-AST2-CALIBRATED-V3.0\DOCUMENT\LOGBOOK_20100707_20100713.ASC
RO-A-RPCMAG-3-AST2-CALIBRATED-V3.0\DOCUMENT\LOGBOOK_20100707_20100713.LBL
RO-A-RPCMAG-3-AST2-CALIBRATED-V3.0\DOCUMENT\RPCMAG_INSTRUMENT.LBL
RO-A-RPCMAG-3-AST2-CALIBRATED-V3.0\DOCUMENT\RPCMAG_INSTRUMENT.PDF
RO-A-RPCMAG-3-AST2-CALIBRATED-V3.0\DOCUMENT\ARCHIVING\RO_IGEP_TR0009_EAICD.ASC
RO-A-RPCMAG-3-AST2-CALIBRATED-V3.0\DOCUMENT\ARCHIVING\RO_IGEP_TR0009_EAICD.DOC
RO-A-RPCMAG-3-AST2-CALIBRATED-V3.0\DOCUMENT\ARCHIVING\RO_IGEP_TR0009_EAICD.LBL
RO-A-RPCMAG-3-AST2-CALIBRATED-V3.0\DOCUMENT\ARCHIVING\RO_IGEP_TR0009_EAICD.PDF
RO-A-RPCMAG-3-AST2-CALIBRATED-V3.0\DOCUMENT\CALIBRATION\RO_IGEP_TR0028_CAL_PROC.LBL
RO-A-RPCMAG-3-AST2-CALIBRATED-V3.0\DOCUMENT\CALIBRATION\RO_IGEP_TR0028_CAL_PROC.PDF
RO-A-RPCMAG-3-AST2-CALIBRATED-V3.0\DOCUMENT\CALIBRATION\RO_IGEP_TR0028_CAL_PROC.TEX
RO-A-RPCMAG-3-AST2-CALIBRATED-V3.0\DOCUMENT\CALIBRATION\RO_IGM_TR0002_CAL_REPORT.LBL
RO-A-RPCMAG-3-AST2-CALIBRATED-V3.0\DOCUMENT\CALIBRATION\RO_IGM_TR0002_CAL_REPORT.PDF
RO-A-RPCMAG-3-AST2-CALIBRATED-V3.0\DOCUMENT\CALIBRATION\RO_IGM_TR0003_CAL_ANALYSIS.LBL
RO-A-RPCMAG-3-AST2-CALIBRATED-V3.0\DOCUMENT\CALIBRATION\RO_IGM_TR0003_CAL_ANALYSIS.PDF
RO-A-RPCMAG-3-AST2-CALIBRATED-V3.0\DOCUMENT\CALIBRATION\RO_IWF_TR0001_AC_ANALYSIS.LBL
RO-A-RPCMAG-3-AST2-CALIBRATED-V3.0\DOCUMENT\CALIBRATION\RO_IWF_TR0001_AC_ANALYSIS.PDF
RO-A-RPCMAG-3-AST2-CALIBRATED-V3.0\DOCUMENT\FLIGHT_REPORTS\RO_IGEP_TR0013_MCRR.ASC
RO-A-RPCMAG-3-AST2-CALIBRATED-V3.0\DOCUMENT\FLIGHT_REPORTS\RO_IGEP_TR0013_MCRR.DOC
RO-A-RPCMAG-3-AST2-CALIBRATED-V3.0\DOCUMENT\FLIGHT_REPORTS\RO_IGEP_TR0013_MCRR.LBL
RO-A-RPCMAG-3-AST2-CALIBRATED-V3.0\DOCUMENT\FLIGHT_REPORTS\RO_IGEP_TR0013_MCRR.PDF
RO-A-RPCMAG-3-AST2-CALIBRATED-V3.0\DOCUMENT\FLIGHT_REPORTS\RO_IGEP_TR0033_LUTETIA_RPT.LBL
RO-A-RPCMAG-3-AST2-CALIBRATED-V3.0\DOCUMENT\FLIGHT_REPORTS\RO_IGEP_TR0033_LUTETIA_RPT.PDF
RO-A-RPCMAG-3-AST2-CALIBRATED-V3.0\DOCUMENT\FLIGHT_REPORTS\RO_IGEP_TR0035_DATA_SUMMARY.LBL
RO-A-RPCMAG-3-AST2-CALIBRATED-V3.0\DOCUMENT\FLIGHT_REPORTS\RO_IGEP_TR0035_DATA_SUMMARY.PDF
RO-A-RPCMAG-3-AST2-CALIBRATED-V3.0\INDEX\INDEX.LBL
RO-A-RPCMAG-3-AST2-CALIBRATED-V3.0\INDEX\INDEX.TAB
RO-A-RPCMAG-3-AST2-CALIBRATED-V3.0\INDEX\INDEXINFO.TXT